

# Product data sheet

Specifications



## Light Module, Harmony XVB7 Modular Tower Light, Green, Ø70mm, Steady, Colored Lens

XVB7C23

**Product availability: Stock - Normally stocked in distribution facility**

### Main

Range of Product	Harmony XVB7
Product or Component Type	Light module
Device Composition	Standard lens
Device short name	XVB7
Mounting diameter	2.8 in (70 mm)
Signalling type	Steady
Light color	LED, green
Material	PC (polycarbonate)
Product Weight	0.231 lb(US) (0.105 kg)
Mounting position	Upright/inverted

### Complementary

Service life in hours	50000 h
[Ue] rated operational voltage	24 V AC/DC
Rated operational voltage limits	21.6...26.4 V AC/DC
Current consumption	35 mA 24 V AC 40 mA 24 V DC
Inrush current	0.5 A
Electrical shock protection class	Class II
[Ui] Rated Insulation Voltage	50 V
[Uimp] rated impulse withstand voltage	0.5 kV

### Environment

Pollution degree	2
Ambient air temperature for operation	-13...140 °F (-25...60 °C)
Ambient Air Temperature for Storage	-40...158 °F (-40...70 °C)
IP Degree of Protection	IP66
Environmental Type ratings	Type 4/4X/12/13 indoor use only
Vibration resistance	6 gn +/- 0.5 mm 10...500 Hz)in operation
Shock resistance	30 gn 6 ms) in operation
Standards	UL 60947-5-1 IEC 60947-5-1 CSA C22.2 No 60947-5-1

Price is "List Price" and may be subject to a trade discount – check with your local distributor or retailer for actual price.

<b>Product Certifications</b>	cULus CCC RCM UKCA CE
-------------------------------	-----------------------------------

## Ordering and shipping details

<b>Category</b>	US10CS222612
<b>Discount Schedule</b>	0CS2
<b>GTIN</b>	3606487129288
<b>Returnability</b>	Yes
<b>Country of origin</b>	DE

## Packing Units

<b>Unit Type of Package 1</b>	PCE
<b>Nbr. of units in pkg.</b>	1
<b>Package 1 Height</b>	2.559 in (6.500 cm)
<b>Package 1 Width</b>	2.874 in (7.300 cm)
<b>Package 1 Length</b>	2.953 in (7.500 cm)
<b>Package weight(Lbs)</b>	3.704 oz (105.000 g)
<b>Unit Type of Package 2</b>	S03
<b>Number of Units in Package 2</b>	60
<b>Package 2 Height</b>	11.811 in (30.000 cm)
<b>Package 2 Width</b>	11.811 in (30.000 cm)
<b>Package 2 Length</b>	15.748 in (40.000 cm)
<b>Package 2 Weight</b>	14.910 lb(US) (6.763 kg)
<b>Unit Type of Package 3</b>	P06
<b>Number of Units in Package 3</b>	480
<b>Package 3 Height</b>	29.528 in (75.000 cm)
<b>Package 3 Width</b>	23.622 in (60.000 cm)
<b>Package 3 Length</b>	31.496 in (80.000 cm)
<b>Package 3 Weight</b>	134.482 lb(US) (61.000 kg)

## Contractual warranty

<b>Warranty (in months)</b>	18
-----------------------------	----



## Environmental Data

Schneider Electric aims to achieve Net Zero status by 2050 through supply chain partnerships, lower impact materials, and circularity via our ongoing “Use Better, Use Longer, Use Again” campaign to extend product lifetimes and recyclability.

[Environmental Data explained >](#)

[How we assess product sustainability >](#)



### Environmental footprint

Total lifecycle Carbon footprint	31 kg CO2 eq.
Carbon footprint of the manufacturing phase [A1 to A3]	1 kg CO2 eq.
Carbon footprint of the distribution phase [A4]	0 kg CO2 eq.
Carbon footprint of the installation phase [A5]	0 kg CO2 eq.
Carbon footprint of the use phase [B2, B3, B4, B6]	30 kg CO2 eq.
Carbon footprint of the end-of-life phase [C1 to C4]	0.1 kg CO2 eq.
Environmental Disclosure	<a href="#">Product Environmental Profile</a>

## Use Better



### Materials and Substances

Packaging made with recycled cardboard	Yes
Packaging without single use plastic	Yes
EU RoHS Directive	<a href="#">Compliant By Exemption</a>
REACH Regulation	<a href="#">Reference contains Substances of Very High Concern above the threshold</a>
California proposition 65	<b>WARNING:</b> This product can expose you to chemicals including: Lead and lead compounds, which is known to the State of California to cause cancer and birth defects or other reproductive harm. For more information go to <a href="http://www.P65Warnings.ca.gov">www.P65Warnings.ca.gov</a>

## Use Longer



### Lifetime extension

Repair	No
--------	----

## Use Again



### Repack and remanufacture

Recyclability potential, in %	87
Circularity Profile	<a href="#">End of Life Information</a>
Take-back	No
WEEE Label	 The product must be disposed on European Union markets following specific waste collection and never end up in rubbish bins.

Dimensions Drawings

Dimensions

---

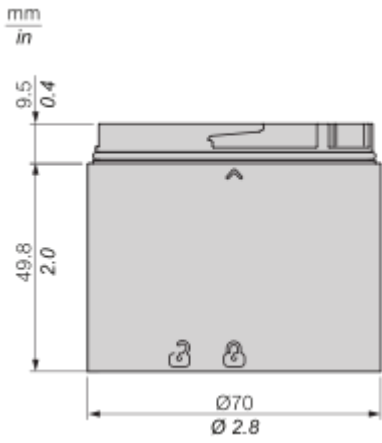

Mounting and Clearance

Mounting Overview



Drawing	Part Number	Part Description
---------	-------------	------------------

A1, A6, A11	XVB7C21B...	24V Base Direct / Tube & Cover
A1, A7, A11	XVB7C31	IO Link Base Direct / Tube & Cover
A1, A8, A11	XVB7C51	USB Base Direct / Tube & Cover
A1, A9, A11	XVB7C61	M12 Base Direct / Tube & Cover
A1, A10, A11	XVB7C21M...	AC Base Direct / Tube & Cover
A2	XVB7C9S...	2 Tones Buzzer
A2	XVB7C9T	8 Tones Buzzer
A2	XVB7C9SS	Self-Adjust Sounder 1 Tone
A3	XVB7L2...	Beacon Steady Lens
	XVB7L6...	Beacon Flashing Lens
A4	XVB7C9V	Editable Voice Alarm
A5	XVB7C2...	Steady Lens
	XVB7C5...	Blinking Lens
	XVB7C6...	Flashing Lens
	XVB7CR...	Rotating Lens
	XVB7CM9	Multi-function Clear lens
A12	XVZ00	1/2" NPT Adapter
A13	XVZ02...	Plastic Fixing Plate With Pole
A14	XVZ100	Alu Ø25mm Pole 100mm Length
A15	XVZ250	Alu Ø25mm Pole 250mm Length
A16	XVZ400	Alu Ø25mm Pole 400mm Length
A17	XVZ800	Alu Ø25mm Pole 800mm Length
A18	XVZ100T	L Bracket Alu Ø25mm Pole 100mm
A19	XVZ250T	L Bracket Alu Ø25mm Pole 250mm
A20	XVZ01...	Plastic Fixing Plate
A21	XVZ11	Metal Fixing Plate
A22	XVZ06...	Plastic Foldable Bracket
A23	XVZ09	Plastic Wall Mount Bracket

A24	XVZ07	Side Entry Adapter
A25	XVZ08	Magnetic Adapter

Technical Illustration

Dimensions

---



Offer Marketing Illustration

Product benefits / Features

---

### Features

Harmony XVB7



Sustainability: high brightness with low power consumption realized via energy efficient LED



Elevated design with a modern twist to enhance machine aesthetic



Modular design for adaptability, ease of maintenance and low inventory



Wide base variety with the option to be connected via USB & IO-link base



Adjustable and customizable sounder with maximum sound pressure of up to 102dB

Offer Marketing Illustration

Product benefits / Features

---

## Technical Benefits

Harmony XVB7

Conformity with IEC, CUL and CCC standards, as well as CE marking

Up to IP66 and type 4X protection ratings

High shock and vibration resistance up to 6g



Energy efficient LED with operating life up to 50,000 hours

Save up to 75% wiring time with M12 connection and push-in terminal

High brightness level with illuminance up to 3000cd/m<sup>2</sup>

Image of product / Alternate images

Alternative

---

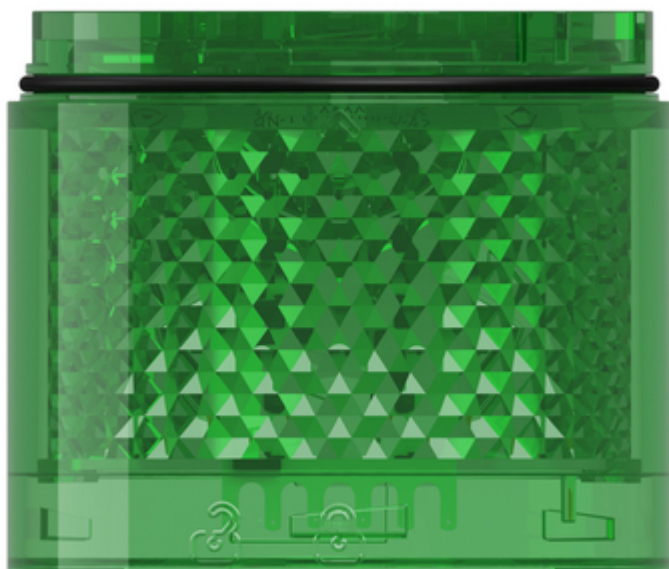
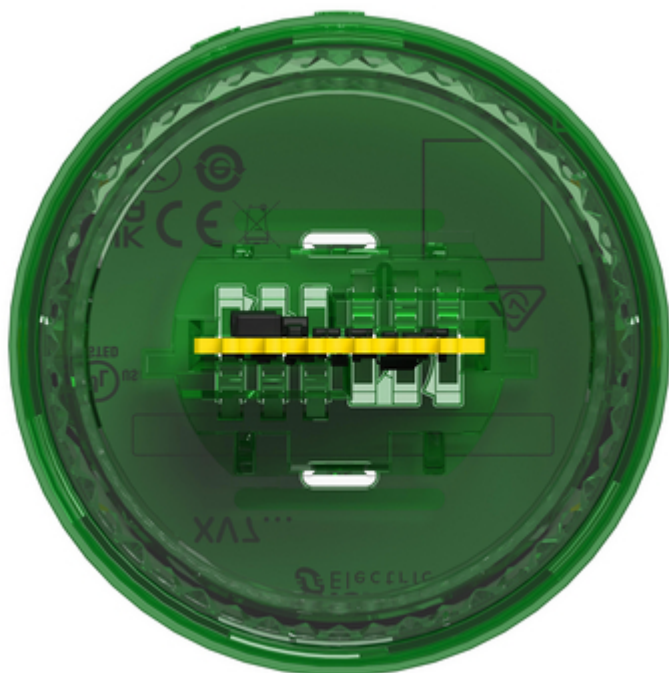

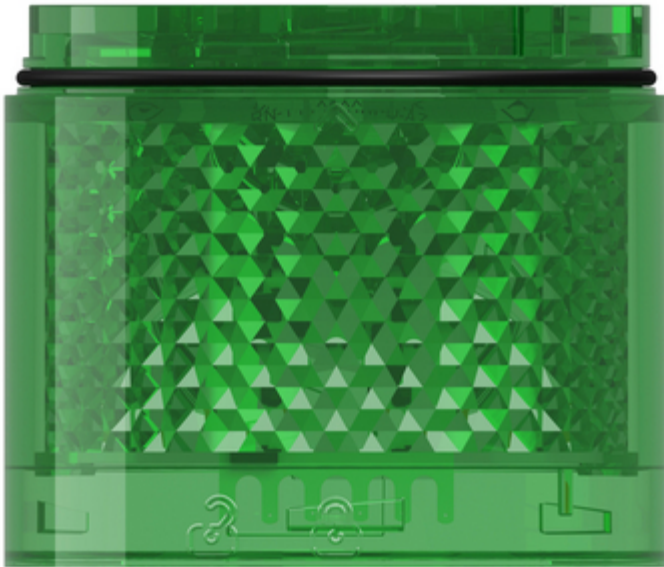
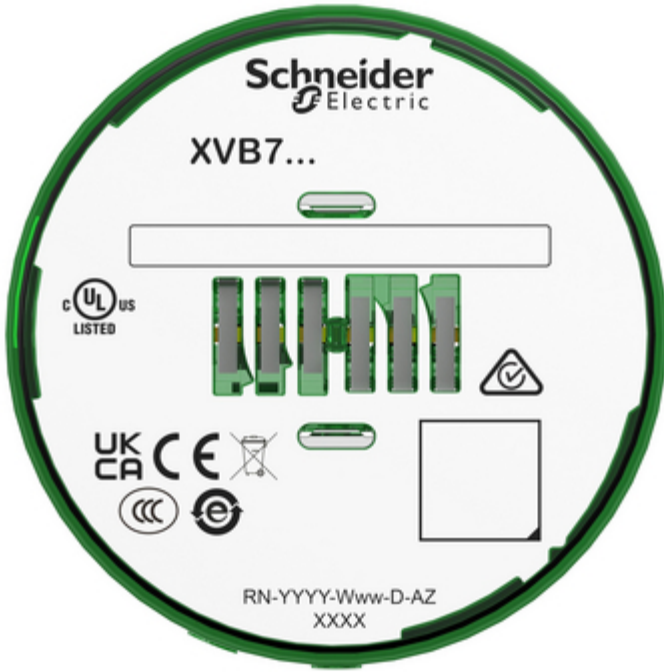

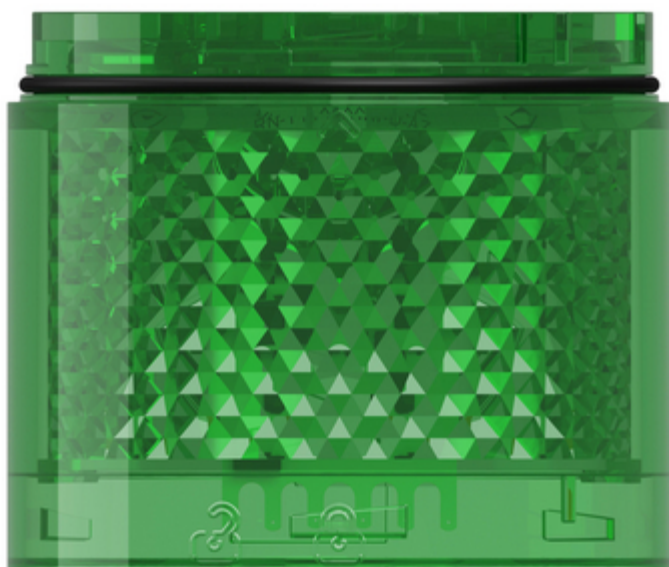
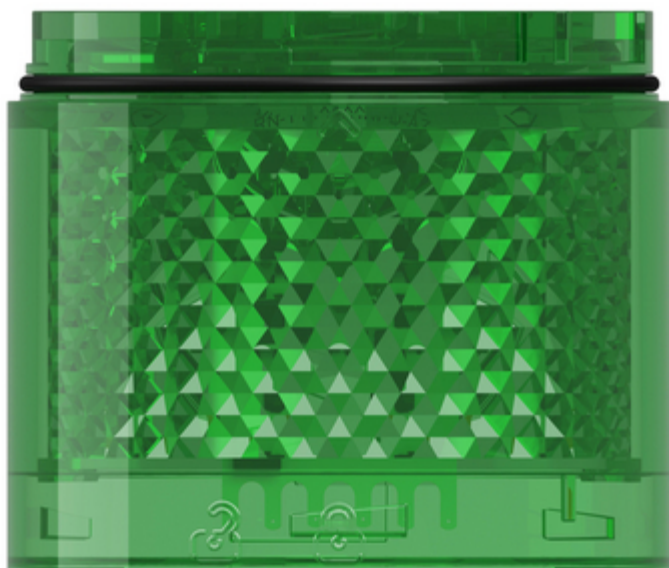

Image of product in real life situation

