

1

2

3

4

## REVISIONS

REV.	ECN NO.	LOCATION	DESCRIPTION	DATE	DESIGN
A0	N/A		INITIAL RELEASE	2024.05.09	

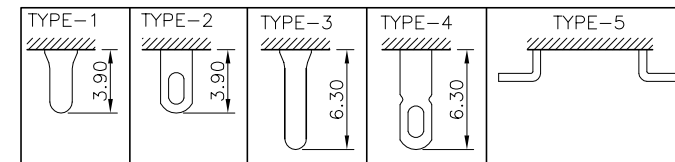
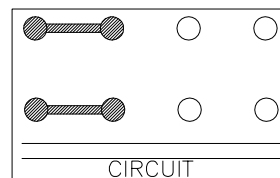
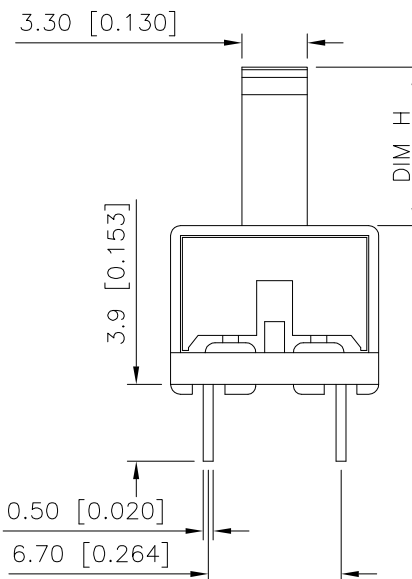
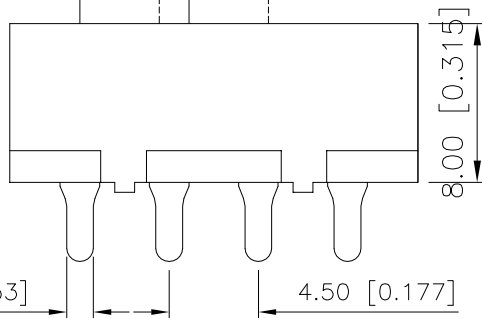
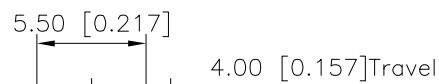
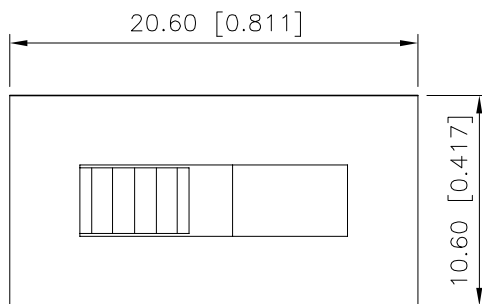

## 规格 Specification:

- 1.额定值 Rating:3A 125/250VAC
- 2.接触电阻 Contact resistance: $\leq 30 \text{ m}\Omega$
- 3.绝缘电阻 Insulation resistance: $\geq 100 \text{ M}\Omega$ (DC500V/Min)
- 4.电气寿命 Electronics life: $> 10000$  cycles
- 5.操作力 Operation force: $500 \pm 200 \text{ gf}$
- 6.所有材料符合Rohs要求 All materials are Rohs compliant

## PART NO.:

SS-X 03 23 P G-XX N 1 X X  
① ② ③ ④ ⑤ ⑥ ⑦ ⑧ ⑨ ⑩ ⑪

- ① SS: 立式拨柄开关;
- ② X: A:金属外壳;  
BLANK: 塑胶外壳;
- ③ 03: 额定值3A;
- ④ 23: 双排三档;
- ⑤ P: 焊板端子;
- ⑥ G: 弧形拨柄;
- ⑦ XX: 拨柄高度H:  $3 \sim 15 \text{ mm}$ ;
- ⑧ N: 方形外壳;
- ⑨ 1: 端子焊脚规格TYPE-1; 2: 端子焊脚规格TYPE-2;  
3: 端子焊脚规格TYPE-3; 4: 端子焊脚规格TYPE-4;  
5: 端子焊脚规格TYPE-5;
- ⑩ X: 拨柄颜色: B-黑色; W-白色; R-红色
- ⑪ X: 主体颜色: B-黑色; W-白色; R-红色

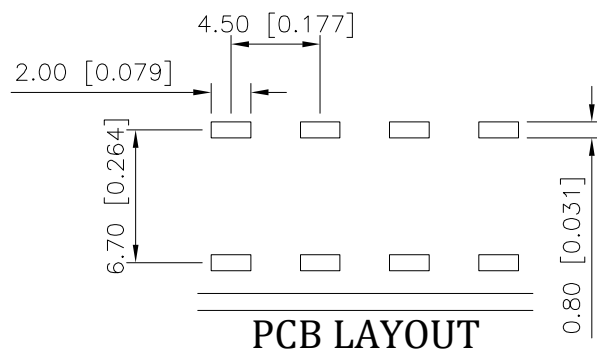

PCB LAYOUT

ANGULAR	$\pm 5^\circ$
X.	$\pm 0.40$
X.x	$\pm 0.30$
X.xx	$\pm 0.20$
X.xxx	$\pm 0.15$
UNSPECIFIED TOLERANCES	

XKB

DESIGN  
CHECKED  
APPROVED

桑 葚

VIEW:  
UNIT: mm/in  
SIZE: A4MODEL TYPE:  
SLIDE SWITCH  
PART NO.:  
SS-A0323PG-XXN1XX  
DWG NO.:

XKB INDUSTRIAL PRECISION CO., LIMITED

SCALE  
N/APAGE  
1/1REVISION  
A0

1

2

3

4

## X-ON Electronics

Largest Supplier of Electrical and Electronic Components

*Click to view similar products for [Slide Switches](#) category:*

*Click to view products by [XKB](#) manufacturer:*

Other Similar products are found below :

[M43R](#) [MHS133K](#) [MMD](#) [1437576-8](#) [MSS12A](#) [1825074-1](#) [1825160-3](#) [1825167-2](#) [K232CB](#) [25139NLDB](#) [25449NAH](#) [SLB1240R45](#)  
[1825078-1](#) [1825269-1](#) [1825270-2](#) [STS141RA04](#) [T2215BEN506](#) [GH46P000001](#) [GH49P010001](#) [CST91246FK](#) [M42A](#) [AYZ0202AG](#)  
[L203091MS02Q](#) [4-1437581-7](#) [X2225CR-437W](#) [48BFSP3M2QT](#) [1101M1S3ZB8E2](#) [1-1437581-1](#) [EG1218REDACTUATOR](#) [MSS42G](#)  
[T105S1CWZBE](#) [SLB124145](#) [SLB1280R5](#) [TG39W000050](#) [25149NAH](#) [25439NAH](#) [25436NAH6](#) [TG36Y000050](#) [NK236X693](#) [SL-](#)  
[1211C1B8](#) [46204LRX](#) [1977143-4](#) [HASS0194](#) [JS0001](#) [25149NAB](#) [GR5-1323-0800](#) [25549NA6](#) [GH36Y410001](#) [25446NAB](#) [GH39P000001](#)