

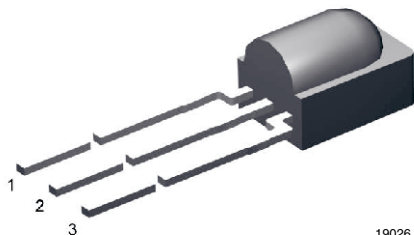

IR Receiver Modules for Remote Control Systems



FEATURES

- Very low supply current
- Photo detector and preamplifier in one package
- Internal filter for PCM frequency
- Improved shielding against EMI
- Supply voltage: 2.5 V to 5.5 V
- Improved immunity against ambient light
- Insensitive to supply voltage ripple and noise



RoHS
COMPLIANT
GREEN
(5-2008)

MECHANICAL DATA

Pinning for HS0038B4D:

1 = OUT, 2 = GND, 3 = V_S

DESCRIPTION

These products are miniaturized receivers for infrared remote control systems. A PIN diode and a preamplifier are assembled on a lead frame, the epoxy package acts as an IR filter.

The demodulated output signal can be directly decoded by a microprocessor. The HS0038B4D is optimized to suppress almost all spurious pulses from energy saving fluorescent lamps but will also suppress some data signals.

This component has not been qualified according to automotive specifications.

PARTS TABLE	
CARRIER FREQUENCY	VERY NOISY ENVIRONMENTS (AGC4)
	PINNING
	1 = OUT, 2 = GND, 3 = V_S
38 kHz	HS0038B4D

BLOCK DIAGRAM

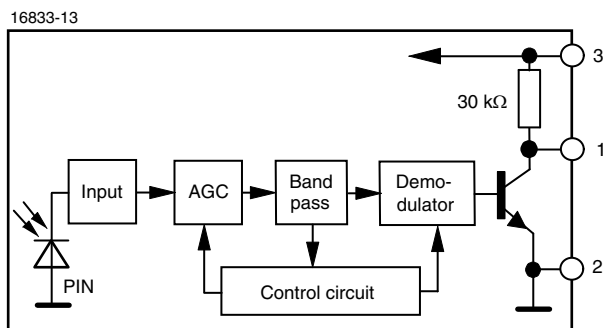

APPLICATION CIRCUIT

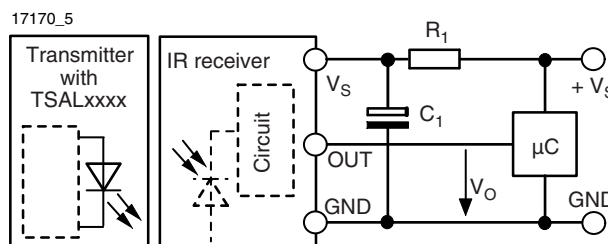

R_1 and C_1 are recommended for protection against EOS. Components should be in the range of $33 \Omega < R_1 < 1 \text{ k}\Omega$, $C_1 > 0.1 \mu\text{F}$.



ABSOLUTE MAXIMUM RATINGS				
PARAMETER	TEST CONDITION	SYMBOL	VALUE	UNIT
Supply voltage		V_S	- 0.3 to + 6	V
Supply current		I_S	3	mA
Output voltage		V_O	- 0.3 to ($V_S + 0.3$)	V
Output current		I_O	5	mA
Junction temperature		T_j	100	°C
Storage temperature range		T_{stg}	- 25 to + 85	°C
Operating temperature range		T_{amb}	- 25 to + 85	°C
Power consumption	$T_{amb} \leq 85 \text{ °C}$	P_{tot}	10	mW
Soldering temperature	$t \leq 10 \text{ s}$, 1 mm from case	T_{sd}	260	°C

Note

- Stresses beyond those listed under “Absolute Maximum Ratings” may cause permanent damage to the device. This is a stress rating only and functional operation of the device at these or any other conditions beyond those indicated in the operational sections of this specification is not implied. Exposure to absolute maximum rating conditions for extended periods may affect the device reliability.

ELECTRICAL AND OPTICAL CHARACTERISTICS ($T_{amb} = 25 \text{ °C}$, unless otherwise specified)						
PARAMETER	TEST CONDITION	SYMBOL	MIN.	TYP.	MAX.	UNIT
Supply current	$E_v = 0, V_S = 3.3 \text{ V}$	I_{SD}	0.27	0.35	0.45	mA
	$E_v = 40 \text{ klx}$, sunlight	I_{SH}		0.45		mA
Supply voltage		V_S	2.5		5.5	V
Transmission distance	$E_v = 0$, test signal see fig. 1, IR diode TSAL6200, $I_F = 200 \text{ mA}$	d		45		m
Output voltage low	$I_{OSL} = 0.5 \text{ mA}$, $E_e = 0.7 \text{ mW/m}^2$, test signal see fig. 1	V_{OSL}			100	mV
Minimum irradiance	Pulse width tolerance: $t_{pi} - 5/f_0 < t_{po} < t_{pi} + 6/f_0$, test signal see fig. 1	$E_e \text{ min.}$		0.12	0.25	mW/m^2
Maximum irradiance	$t_{pi} - 5/f_0 < t_{po} < t_{pi} + 6/f_0$, test signal see fig. 1	$E_e \text{ max.}$	30			W/m^2
Directivity	Angle of half transmission distance	$\phi_{1/2}$		± 45		deg

TYPICAL CHARACTERISTICS ($T_{amb} = 25 \text{ °C}$, unless otherwise specified)

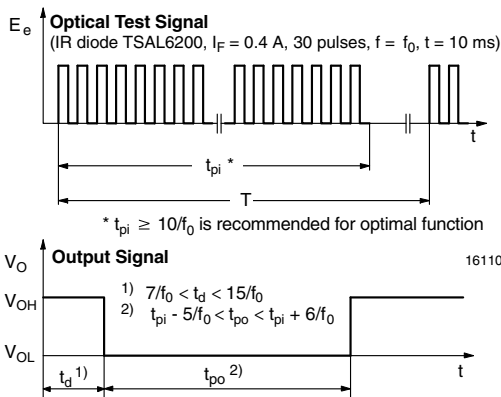

Fig. 1 - Output Active Low

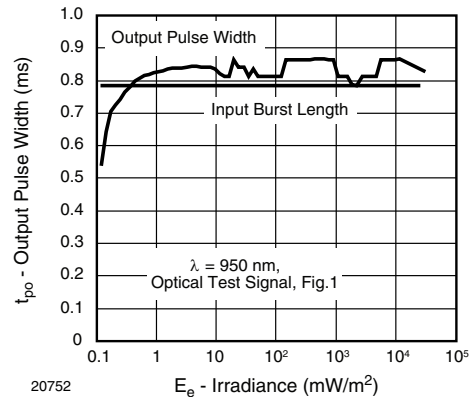

Fig. 2 - Pulse Length and Sensitivity in Dark Ambient

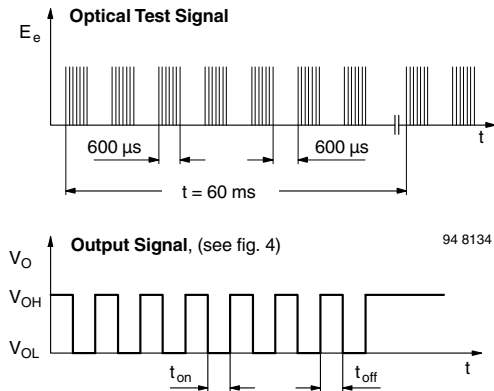

Fig. 3 - Output Function

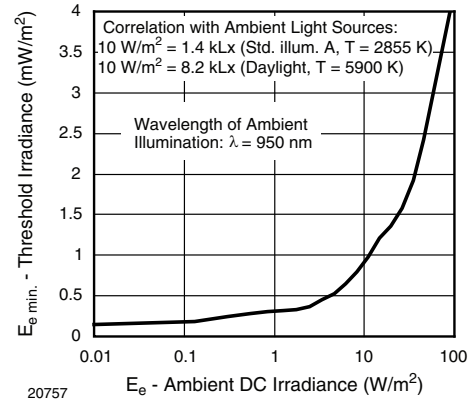

Fig. 6 - Sensitivity in Bright Ambient

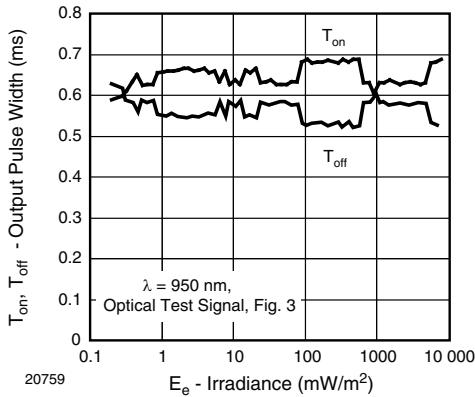

Fig. 4 - Output Pulse Diagram

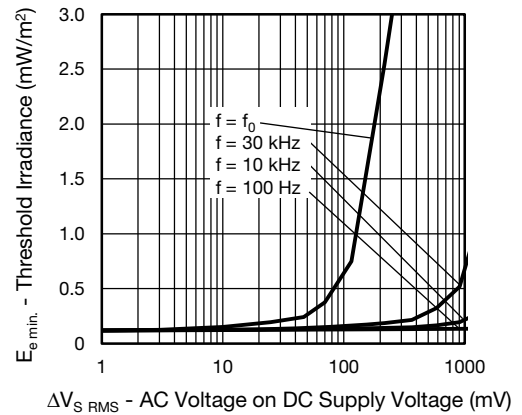

Fig. 7 - Sensitivity vs. Supply Voltage Disturbances

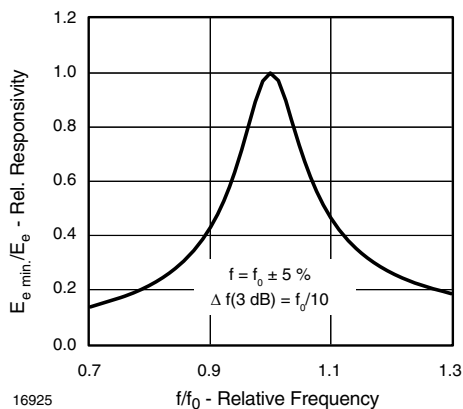

Fig. 5 - Frequency Dependence of Responsivity

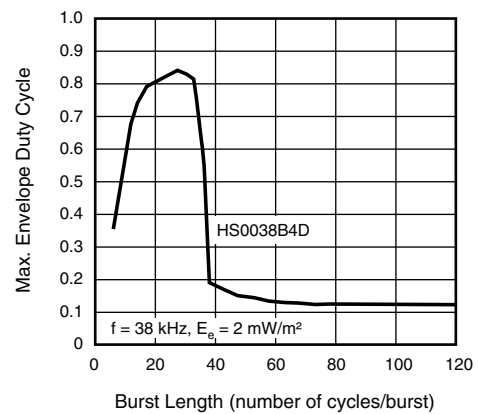

Fig. 8 - Max. Envelope Duty Cycle vs. Burst Length

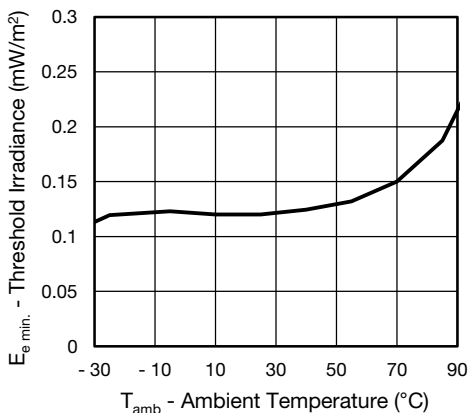

Fig. 9 - Sensitivity vs. Ambient Temperature

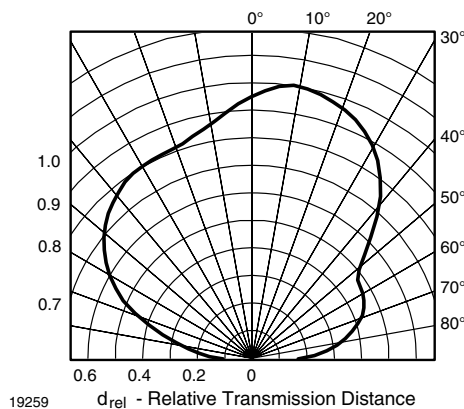

Fig. 12 - Vertical Directivity

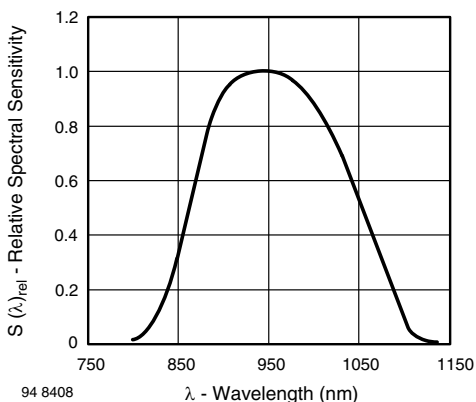

Fig. 10 - Relative Spectral Sensitivity vs. Wavelength

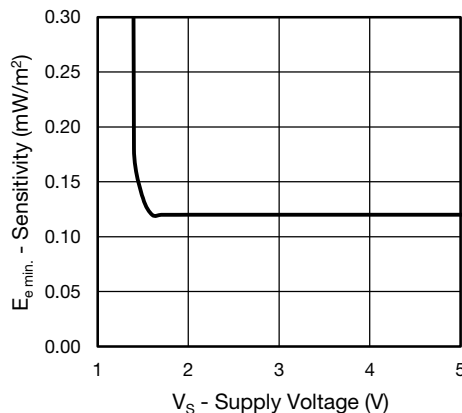

Fig. 13 - Sensitivity vs. Supply Voltage

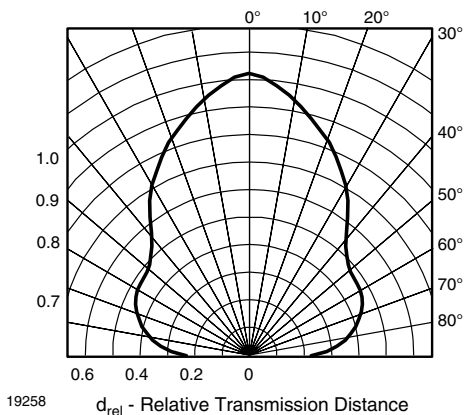

Fig. 11 - Horizontal Directivity



SUITABLE DATA FORMAT

These products are designed to suppress spurious output pulses due to noise or disturbance signals. Data and disturbance signals can be distinguished by the devices according to carrier frequency, burst length and envelope duty cycle. The data signal should be close to the band-pass center frequency (e.g. 38 kHz) and fulfill the conditions in the table below.

When a data signal is applied to the IR receiver in the presence of a disturbance signal, the sensitivity of the receiver is reduced to insure that no spurious pulses are present at the output. Some examples of disturbance signals which are suppressed are:

- DC light (e.g. from tungsten bulb or sunlight)
- Continuous signals at any frequency
- Strongly or weakly modulated noise from fluorescent lamps with electronic ballasts (see figure 15 or figure 16)

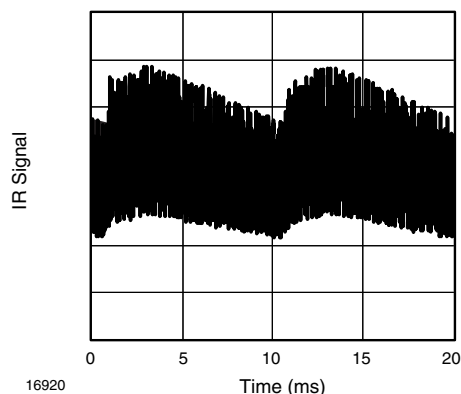

Fig. 14 - IR Signal from Fluorescent Lamp with Low Modulation

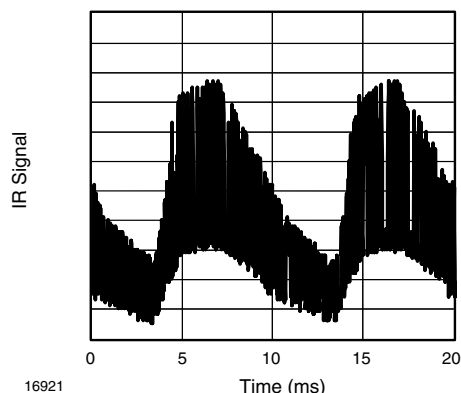
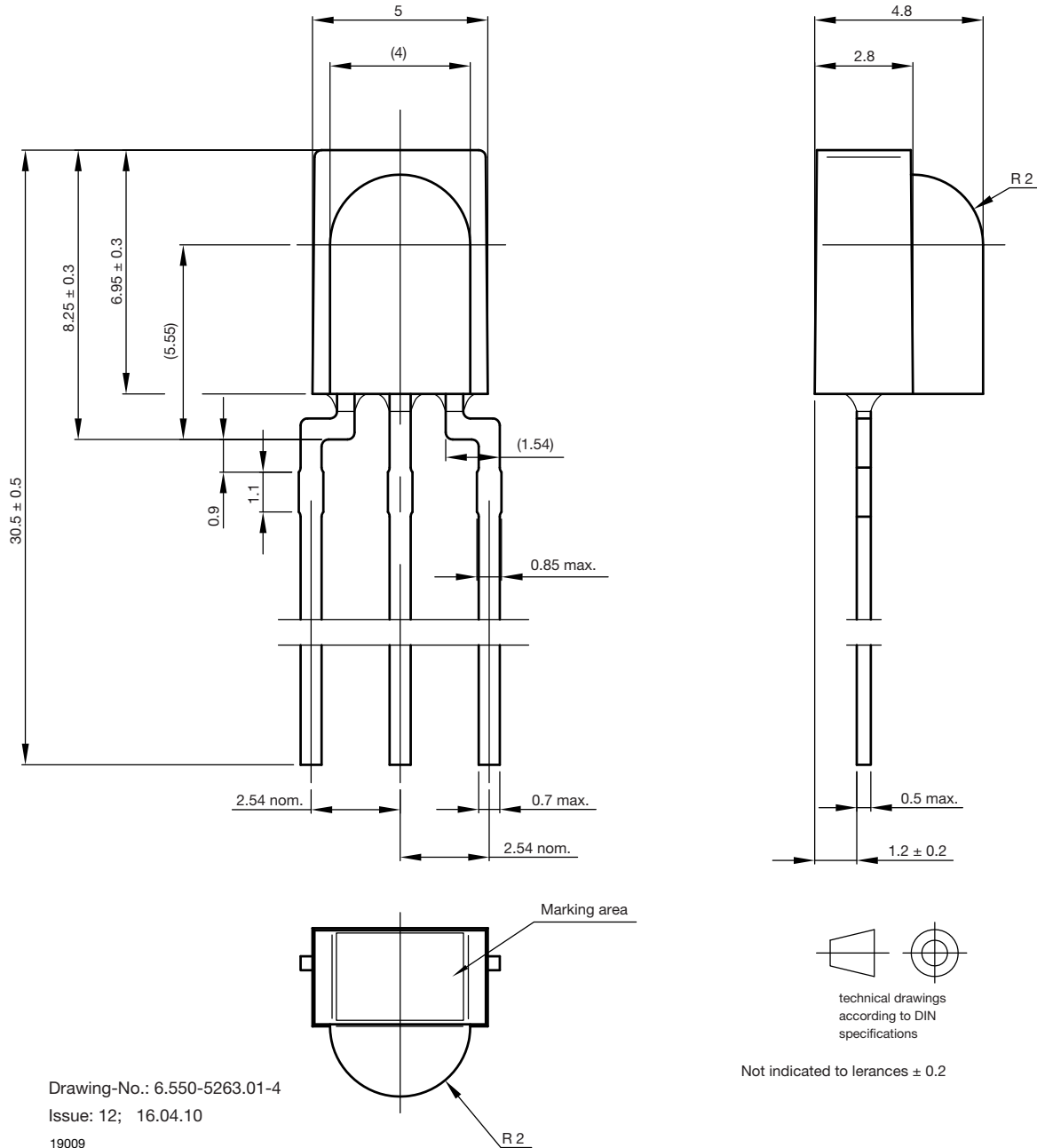

Fig. 15 - IR Signal from Fluorescent Lamp with High Modulation

	HS0038B4D
Minimum burst length	10 cycles/burst
After each burst of length a minimum gap time is required of	10 to 35 cycles ≥ 10 cycles
For bursts greater than a minimum gap time in the data stream is needed of	35 cycles > 10 x burst length
Maximum number of continuous short bursts/second	1500
Recommended for NEC code	yes
Recommended for RC5/RC6 code	yes
Recommended for Sony code	no
Recommended for Thomson 56 kHz code	yes
Recommended for Mitsubishi code (38 kHz, preburst 8 ms, 16 bit)	no
Recommended for Sharp code	yes
Suppression of interference from fluorescent lamps	Even extreme disturbance signals are suppressed



PACKAGE DIMENSIONS in millimeters



Drawing-No.: 6.550-5263.01-4
Issue: 12; 16.04.10
19009

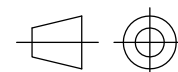

technical drawings according to DIN specifications

Not indicated to tolerances ± 0.2

X-ON Electronics

Largest Supplier of Electrical and Electronic Components

Click to view similar products for [Vishay](#) manufacturer:

Other Similar products are found below :

[006-1-0](#) [006-1-1](#) [006-1-2](#) [006-1-3](#) [006-2-0](#) [006-2-1/621](#) [008T000](#) [009-43PG](#) [010-007220-002REV A](#) [010019AM](#) [011-1-11](#) [011-1-31](#)
[014160DM](#) [015-1-11](#) [015-1-31](#) [015-2-11](#) [017115XM](#) [018-1-11](#) [01C1001FF](#) [01C1001FP](#) [01C1002FF](#) [01C1002FP](#) [01C1002JF](#) [01C1002JP](#)
[01C1501JP](#) [01C3001FF](#) [01C3001SFC3](#) [01C5001FP](#) [01C7001FP](#) [01C8001FP](#) [01C8001JP](#) [01C9001JP](#) [01M1002FF](#) [01M1002FP](#) [01M1002JF](#)
[01M1502SPA3](#) [01M3002FP](#) [01M6001FP](#) [01T1001FP](#) [01T1002FF](#) [01T1002FP](#) [01T1002JF](#) [020010030060020](#) [021P-1-11](#) [023346AB](#)
[02C0500JF](#) [02C1000JF](#) [02C1001JP](#) [02C2000JP](#) [02C3000JP](#)