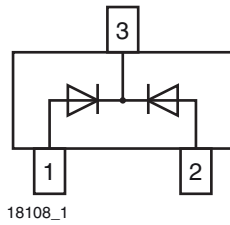
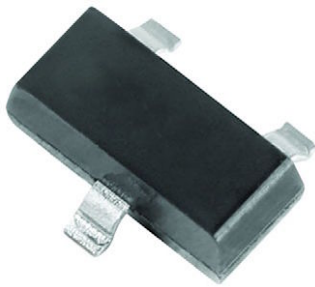




# Dual Common Cathode Small Signal High Voltage Switching Diode



### FEATURES

- Silicon epitaxial planar diode
- Fast switching dual common cathode diode, especially suited for applications requiring high voltage capability
- AEC-Q101 qualified available
- Base P/N-E3 - RoHS-compliant, commercial grade
- Base P/N-HE3 - RoHS-compliant, AEC-Q101 qualified
- Material categorization: for definitions of compliance please see [www.vishay.com/doc?99912](http://www.vishay.com/doc?99912)



RoHS COMPLIANT

**DESIGN SUPPORT TOOLS** click logo to get started



### MECHANICAL DATA

**Case:** SOT-23

**Weight:** approx. 8.8 mg

**Packaging codes / options:**

18/10K per 13" reel (8 mm tape), 10K/box

08/3K per 7" reel (8 mm tape), 15K/box

PARTS TABLE				
PART	ORDERING CODE	CIRCUIT CONFIGURATION	TYPE MARKING	REMARKS
GSD2004C	GSD2004C-E3-08 or GSD2004C-E3-18	Common cathode	DBC	Tape and reel
	GSD2004C-HE3-08 or GSD2004C-HE3-18			

ABSOLUTE MAXIMUM RATINGS (T <sub>amb</sub> = 25 °C, unless otherwise specified)				
PARAMETER	TEST CONDITION	SYMBOL	VALUE	UNIT
Continuous reverse voltage		V <sub>R</sub>	240	V
Peak repetitive reverse voltage		V <sub>RRM</sub>	300	V
Forward current (continuous)		I <sub>F</sub>	225	mA
Peak repetitive forward current		I <sub>FRM</sub>	625	mA
Non-repetitive peak forward current	t <sub>p</sub> = 1 μs	I <sub>FSM</sub>	4	A
	t <sub>p</sub> = 1 s		1	A
Power dissipation <sup>(1)</sup>		P <sub>tot</sub>	350	mW

THERMAL CHARACTERISTICS (T <sub>amb</sub> = 25 °C, unless otherwise specified)				
PARAMETER	TEST CONDITION	SYMBOL	VALUE	UNIT
Typical thermal resistance junction to ambient air <sup>(1)</sup>		R <sub>thJA</sub>	357	°C/W
Junction temperature		T <sub>j</sub>	150	°C
Storage temperature range		T <sub>stg</sub>	-65 to +150	°C
Operating temperature range		T <sub>op</sub>	-55 to +150	°C

**Note**

<sup>(1)</sup> Device on fiberglass substrate

<b>ELECTRICAL CHARACTERISTICS</b> ( $T_{amb} = 25\text{ }^{\circ}\text{C}$ , unless otherwise specified)						
PARAMETER	TEST CONDITION	SYMBOL	MIN.	TYP.	MAX.	UNIT
Reverse breakdown voltage	$I_R = 100\text{ }\mu\text{A}$	$V_{BR}$	300			V
Leakage current	$V_R = 240\text{ V}$	$I_R$			100	nA
	$V_R = 240\text{ V}, T_J = 150\text{ }^{\circ}\text{C}$	$I_R$			100	$\mu\text{A}$
Forward voltage	$I_F = 20\text{ mA}$	$V_F$		0.83	0.87	V
	$I_F = 100\text{ mA}$	$V_F$			1	V
Diode capacitance	$V_F = V_R = 0, f = 1\text{ MHz}$	$C_D$			5	pF
Reverse recovery time	$I_F = I_R = 30\text{ mA}, I_R = 3\text{ mA}, R_L = 100\text{ }\Omega$	$t_{rr}$			50	ns

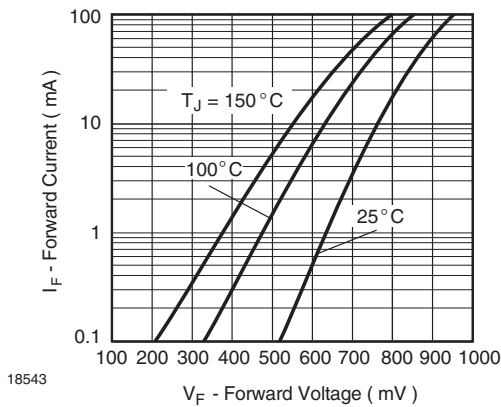
**TYPICAL CHARACTERISTICS** ( $T_{amb} = 25\text{ }^{\circ}\text{C}$ , unless otherwise specified)


Fig. 1 - Typical Instantaneous Forward Characteristics

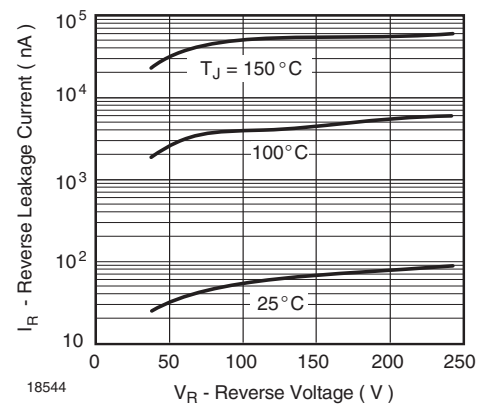


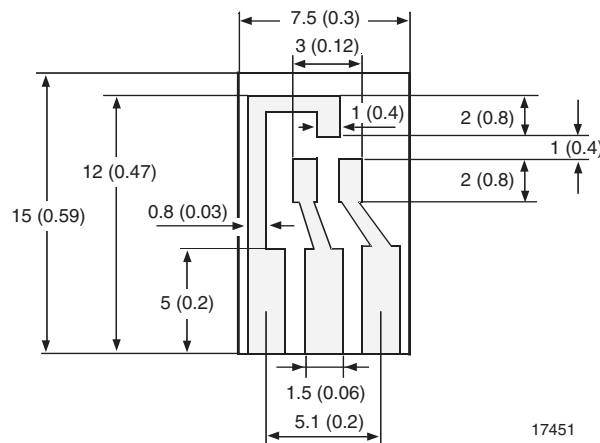
Fig. 2 - Typical Reverse Characteristics

**LAYOUT FOR  $R_{thJA}$  TEST**

Thickness:

Fiberglass 1.5 mm (0.059 in.)

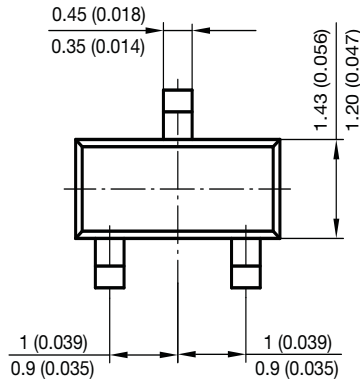
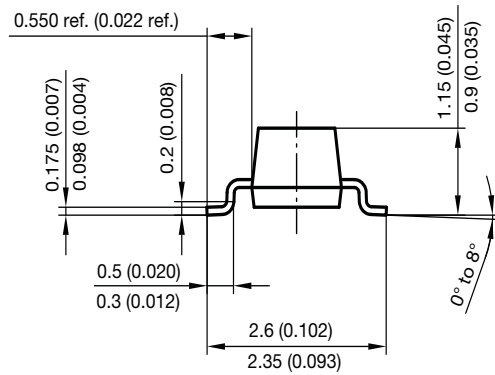
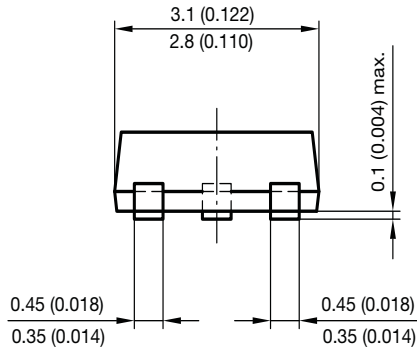
Copper leads 0.3 mm (0.012 in.)



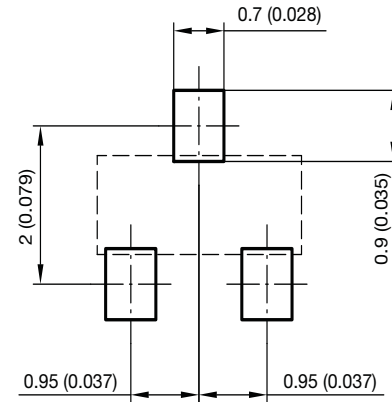
17451



PACKAGE DIMENSIONS in millimeters (inches): SOT-23



Foot print recommendation:



Document no.: 6.541-5014.01-4  
Rev. 8 - Date: 23.Sept.2009  
17418



## **Disclaimer**

ALL PRODUCT, PRODUCT SPECIFICATIONS AND DATA ARE SUBJECT TO CHANGE WITHOUT NOTICE TO IMPROVE RELIABILITY, FUNCTION OR DESIGN OR OTHERWISE.

Vishay Intertechnology, Inc., its affiliates, agents, and employees, and all persons acting on its or their behalf (collectively, "Vishay"), disclaim any and all liability for any errors, inaccuracies or incompleteness contained in any datasheet or in any other disclosure relating to any product.

Vishay makes no warranty, representation or guarantee regarding the suitability of the products for any particular purpose or the continuing production of any product. To the maximum extent permitted by applicable law, Vishay disclaims (i) any and all liability arising out of the application or use of any product, (ii) any and all liability, including without limitation special, consequential or incidental damages, and (iii) any and all implied warranties, including warranties of fitness for particular purpose, non-infringement and merchantability.

Statements regarding the suitability of products for certain types of applications are based on Vishay's knowledge of typical requirements that are often placed on Vishay products in generic applications. Such statements are not binding statements about the suitability of products for a particular application. It is the customer's responsibility to validate that a particular product with the properties described in the product specification is suitable for use in a particular application. Parameters provided in datasheets and / or specifications may vary in different applications and performance may vary over time. All operating parameters, including typical parameters, must be validated for each customer application by the customer's technical experts. Product specifications do not expand or otherwise modify Vishay's terms and conditions of purchase, including but not limited to the warranty expressed therein.

Hyperlinks included in this datasheet may direct users to third-party websites. These links are provided as a convenience and for informational purposes only. Inclusion of these hyperlinks does not constitute an endorsement or an approval by Vishay of any of the products, services or opinions of the corporation, organization or individual associated with the third-party website. Vishay disclaims any and all liability and bears no responsibility for the accuracy, legality or content of the third-party website or for that of subsequent links.

Except as expressly indicated in writing, Vishay products are not designed for use in medical, life-saving, or life-sustaining applications or for any other application in which the failure of the Vishay product could result in personal injury or death. Customers using or selling Vishay products not expressly indicated for use in such applications do so at their own risk. Please contact authorized Vishay personnel to obtain written terms and conditions regarding products designed for such applications.

No license, express or implied, by estoppel or otherwise, to any intellectual property rights is granted by this document or by any conduct of Vishay. Product names and markings noted herein may be trademarks of their respective owners.

## X-ON Electronics

Largest Supplier of Electrical and Electronic Components

*Click to view similar products for [Vishay](#) manufacturer:*

Other Similar products are found below :

[006-1-0](#) [006-1-1](#) [006-1-2](#) [006-1-3](#) [006-2-0](#) [006-2-1/621](#) [008T000](#) [009-43PG](#) [010-007220-002REV A](#) [010019AM](#) [011-1-11](#) [011-1-31](#)  
[014160DM](#) [015-1-11](#) [015-1-31](#) [015-2-11](#) [017115XM](#) [018-1-11](#) [01C1001FF](#) [01C1001FP](#) [01C1002FF](#) [01C1002FP](#) [01C1002JF](#) [01C1002JP](#)  
[01C1501JP](#) [01C3001FF](#) [01C3001SFC3](#) [01C5001FP](#) [01C7001FP](#) [01C8001FP](#) [01C8001JP](#) [01C9001JP](#) [01M1002FF](#) [01M1002FP](#) [01M1002JF](#)  
[01M1502SPA3](#) [01M3002FP](#) [01M6001FP](#) [01T1001FP](#) [01T1002FF](#) [01T1002FP](#) [01T1002JF](#) [020010030060020](#) [021P-1-11](#) [023346AB](#)  
[02C0500JF](#) [02C1000JF](#) [02C1001JP](#) [02C2000JP](#) [02C3000JP](#)