

LP3879 Micropower 800mA Low Noise "Ceramic Stable" Voltage Regulator for Low Voltage Applications

Check for Samples: [LP3879](#)

FEATURES

- **Standard Output Voltage: 1.00V, 1.20V**
- **Custom Voltages Available from 1.0V to 1.2V (50 mV Increments)**
- **Input Voltage: 2.5 to 6V**
- **1% Initial Output Accuracy**
- **Designed for Use with Low ESR Ceramic Capacitors**
- **Very Low Output Noise**
- **Sense Option Improves Load Regulation**
- **8-Lead SO PowerPad and WSON Surface Mount Packages**
- **<10 μ A Quiescent Current in Shutdown**
- **Low Ground Pin Current at all Loads**
- **High Peak Current Capability**
- **Over-Temperature/Over-Current Protection**
- **-40°C to +125°C Junction Temperature Range**

APPLICATIONS

- **ASIC Power Supplies In:**
 - **Desktops, Notebooks and Graphic Cards**
 - **Set Top Boxes, Printers and Copiers**
- **DSP and FPGA Power Supplies**
- **SMPS Post-Regulator**
- **Medical Instrumentation**

DESCRIPTION

The LP3879 is a 800 mA fixed-output voltage regulator designed to provide high performance and low noise in applications requiring output voltages between 1.0V and 1.2V.

Using an optimized VIP (Vertically Integrated PNP) process, the LP3879 delivers superior performance:

Ground Pin Current: Typically 5.5 mA @ 800 mA load, and 200 μ A @ 100 μ A load.

Low Power Shutdown: The LP3879 draws less than 10 μ A quiescent current when shutdown pin is pulled low.

Precision Output: Ensured output voltage accuracy is 1% at room temperature.

Low Noise: Broadband output noise is only 18 μ V (typical) with 10 nF bypass capacitor.



Please be aware that an important notice concerning availability, standard warranty, and use in critical applications of Texas Instruments semiconductor products and disclaimers thereto appears at the end of this data sheet.

All trademarks are the property of their respective owners.

Basic Application Circuit

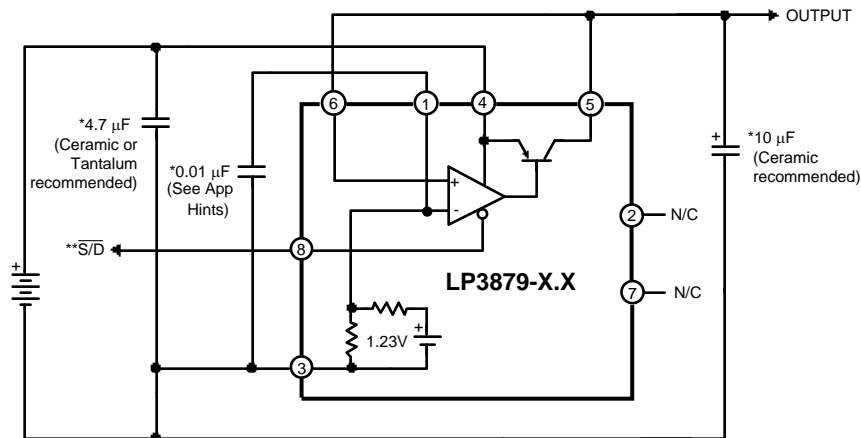

*Capacitance values shown are minimum required to assure stability. Larger output capacitor provides improved dynamic response. Output capacitor must meet ESR requirements (see [Application Information](#)).
 **The Shutdown pin must be actively terminated (see [Application Information](#)). Tie to INPUT (Pin 4) if not used.

Connection Diagram

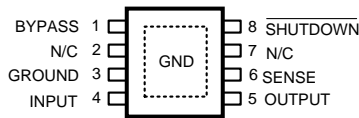

**Figure 1. Top View
8-Lead SO PowerPad
See DDA0008B Package**

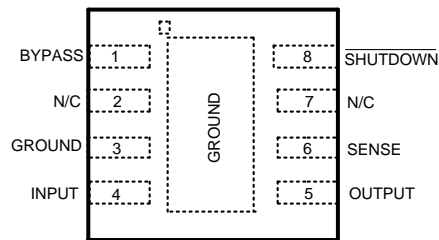

**Figure 2. Top View
8-Lead WSON
See NGT0008A Package**

PIN DESCRIPTIONS

Pin	Name	Function
1	BYPASS	The capacitor connected between BYPASS and GROUND lowers output noise voltage level and is required for loop stability.
2	N/C	DO NOT CONNECT. This pin is used for post package test and must be left floating.
3	GROUND	Device ground.
4	INPUT	Input source voltage.
5	OUTPUT	Regulated output voltage.
6	SENSE	Remote Sense. Tie directly to output or remotely at point of load for best regulation.
7	N/C	No internal connection.
8	SHUTDOWN	Output is enabled above turn-on threshold voltage. Pull down to turn off regulator output.
SO PowerPad, WSON	SUBSTRATE GROUND	The exposed die attach pad should be connected to a thermal pad at ground potential. For additional information on using Texas Instruments' Non Pull Back WSON package, please refer to WSON application note SNOA401



These devices have limited built-in ESD protection. The leads should be shorted together or the device placed in conductive foam during storage or handling to prevent electrostatic damage to the MOS gates.

Absolute Maximum Ratings⁽¹⁾⁽²⁾

Storage Temperature Range	-65°C to +150°C
Operating Junction Temperature Range	-40°C to +125°C
Lead Temperature (Soldering, 5 seconds)	260°C
ESD Rating ⁽³⁾	2 kV
Shutdown Pin	1kV
Power Dissipation ⁽⁴⁾	Internally Limited
Input Supply Voltage (Survival)	-0.3V to +16V
Input Supply Voltage (Typical Operating)	2.5V to +6V
SENSE Pin	-0.3V to +6V
Output Voltage (Survival) ⁽⁵⁾	-0.3V to +6V
I _{OUT} (Survival)	Short Circuit Protected
Input-Output Voltage (Survival) ⁽⁶⁾	-0.3V to +16V

- (1) Absolute Maximum Ratings indicate limits beyond which damage to the component may occur. Electrical specifications do not apply when operating the device outside of its rated operating conditions.
- (2) If Military/Aerospace specified devices are required, please contact the Texas Instruments Sales Office/Distributors for availability and specifications.
- (3) ESD testing was performed using Human Body Model, a 100 pF capacitor discharged through a 1.5 kΩ resistor.
- (4) The maximum allowable power dissipation is a function of the maximum junction temperature, T_J(MAX), the junction-to-ambient thermal resistance, θ_{J-A}, and the ambient temperature, T_A. The maximum allowable power dissipation at any ambient temperature is calculated using:

$$P(MAX) = \frac{T_J(MAX) - T_A}{\theta_{J-A}}$$
 The value of θ_{J-A} for the WSON and SO PowerPad packages are specifically dependent on PCB trace area, trace material, and the number of layers and thermal vias. If a four layer board is used with maximum vias from the IC center to the heat dissipating copper layers, values of θ_{J-A} which can be obtained are approximately 60°C/W for the SO PowerPad and 40°C/W for the WSON package. Exceeding the maximum allowable power dissipation will cause excessive die temperature, and the regulator will go into thermal shutdown.
- (5) If used in a dual-supply system where the regulator load is returned to a negative supply, the LP3879 output must be diode-clamped to ground.
- (6) The output PNP structure contains a diode between the V_{IN} and V_{OUT} terminals that is normally reverse-biased. Forcing the output above the input will turn on this diode and may induce a latch-up mode which can damage the part (see Application Hints).

Electrical Characteristics

Limits in standard typeface are for $T_J = 25^\circ\text{C}$, and limits in **boldface type** apply over the temperature range of -40°C to 125°C . Limits are ensured through design, testing, or correlation. The limits are used to calculate the Average Outgoing Quality Level (AOQL). Unless otherwise specified: $V_{IN} = 3.0\text{V}$, $V_{OUT} = 1\text{V}$, $I_L = 1\text{ mA}$, $C_{OUT} = 10\text{ }\mu\text{F}$, $C_{IN} = 4.7\text{ }\mu\text{F}$, $V_{S/D} = 2\text{V}$, $C_{BYPASS} = 10\text{ nF}$.

Symbol	Parameter	Conditions	Min ⁽¹⁾	Typical ⁽²⁾	Max ⁽¹⁾	Units
V_O	Output Voltage Tolerance		-1.0	1.00	1.0	% V_{nom}
		$1\text{ mA} \leq I_L \leq 800\text{ mA}$, $3.0\text{V} \leq V_{IN} \leq 6\text{V}$	-2.0 -3.0	1.00	2.0 3.0	
$\frac{\Delta V_{OUT}}{\Delta V_{IN}}$	Output Voltage Line Regulation	$3.0\text{V} \leq V_{IN} \leq 6\text{V}$		0.007	0.014	% V
					0.032	
$V_{IN}(\text{min})$	Minimum Input Voltage Required To Maintain Output Regulation	$I_L = 800\text{ mA}$, $V_{OUT} \geq V_{OUT(NOM)} - 1\%$		2.5	3.1	V
		$I_L = 800\text{ mA}$, $V_{OUT} \geq V_{OUT(NOM)} - 1\%$ $0 \leq T_J \leq 125^\circ\text{C}$		2.5	2.8	
		$I_L = 750\text{ mA}$, $V_{OUT} \geq V_{OUT(NOM)} - 1\%$		2.5	3.0	
I_{GND}	Ground Pin Current	$I_L = 100\text{ }\mu\text{A}$		200	250	μA
					275	
		$I_L = 200\text{ mA}$		1.5	2	mA
					3.3	
$I_L = 800\text{ mA}$		5.5	8.5	mA		
			15			
$I_O(\text{PK})$	Peak Output Current	$V_{OUT} \geq V_{OUT(NOM)} - 5\%$		1200		mA
$I_O(\text{MAX})$	Short Circuit Current	$R_L = 0$ (Steady State)		1400		
e_n	Output Noise Voltage (RMS)	$\text{BW} = 100\text{ Hz to } 100\text{ kHz}$ $C_{BYPASS} = 10\text{ nF}$		18		$\mu\text{V}(\text{RMS})$
$\frac{\Delta V_{OUT}}{\Delta V_{IN}}$	Ripple Rejection	$f = 1\text{ kHz}$		60		dB
SHUTDOWN INPUT						
$V_{S/D}$	S/D Input Voltage	$V_H = \text{Output ON}$		1.4	1.6	V
		$V_L = \text{Output OFF}$, $I_{IN} \leq 10\text{ }\mu\text{A}$	0.1	0.50		
		$V_{OUT} \leq 10\text{ mV}$, $I_{IN} \leq 50\text{ }\mu\text{A}$		0.6		
$I_{S/D}$	S/D Input Current	$V_{S/D} = 0$		0.02	-1	μA
		$V_{S/D} = 5\text{V}$		5	15	

- (1) Limits are ensured through testing, statistical correlation, or design.
(2) Typical numbers represent the most likely norm for 25°C operation.

Typical Performance Characteristics

Unless otherwise specified: $V_{IN} = 3.3V$, $V_{OUT} = 1V$, $I_L = 1\text{ mA}$, $C_{IN} = 4.7\ \mu\text{F}$, $C_{OUT} = 10\ \mu\text{F}$, $V_{SD} = 2V$, $C_{BYP} = 10\ \text{nF}$, $T_J = 25^\circ\text{C}$.

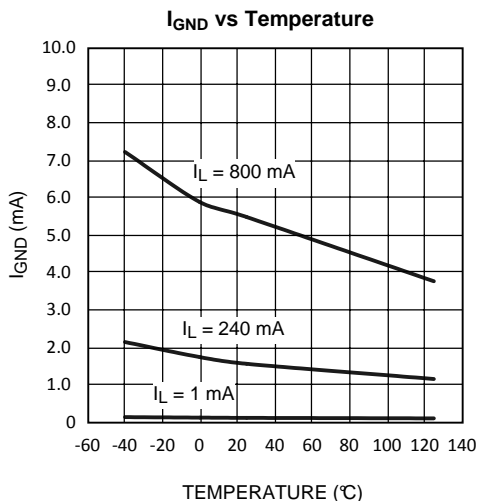

Figure 3.

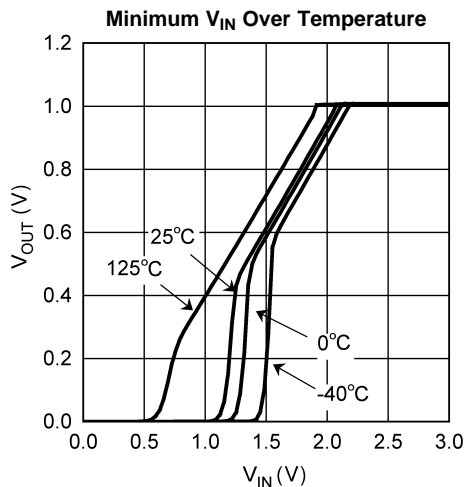

Figure 4.

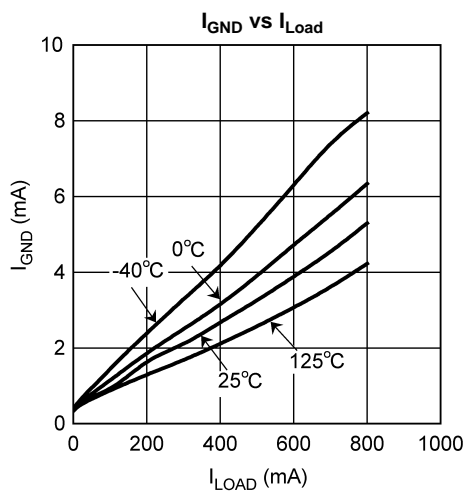

Figure 5.

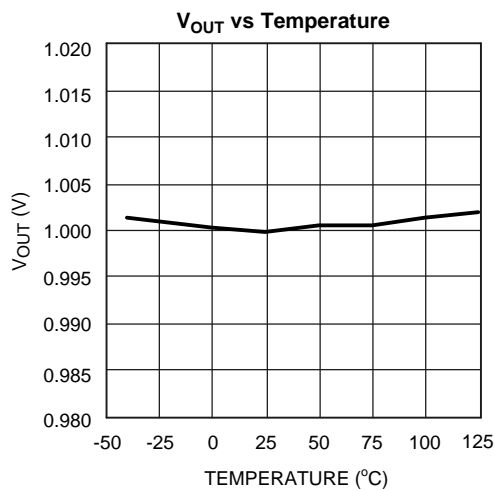

Figure 6.

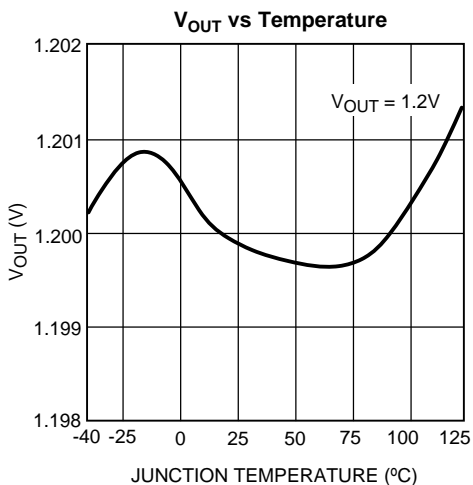

Figure 7.

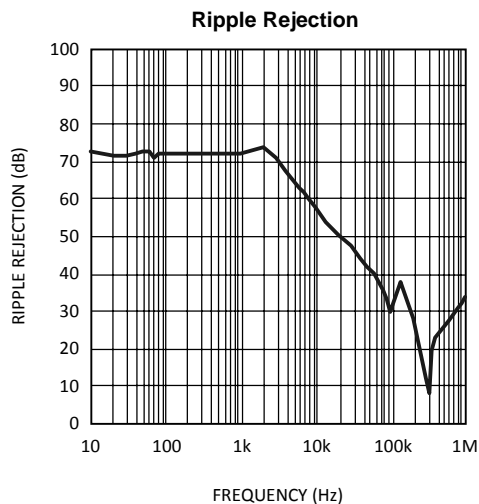

Figure 8.

Typical Performance Characteristics (continued)

Unless otherwise specified: $V_{IN} = 3.3V$, $V_{OUT} = 1V$, $I_L = 1\text{ mA}$, $C_{IN} = 4.7\text{ }\mu\text{F}$, $C_{OUT} = 10\text{ }\mu\text{F}$, $V_{S/D} = 2V$, $C_{BYP} = 10\text{ nF}$, $T_J = 25^\circ\text{C}$.

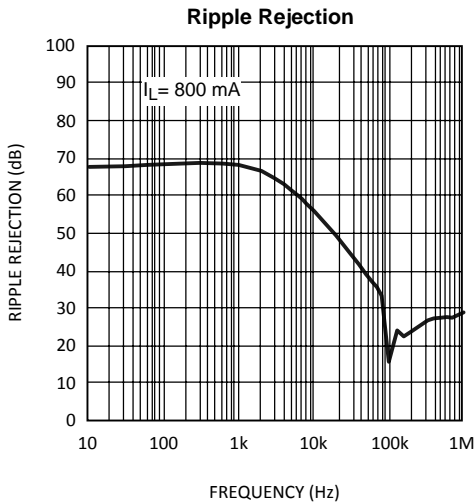

Figure 9.

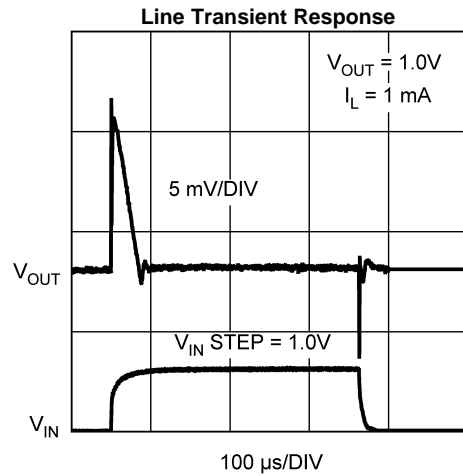

Figure 10.

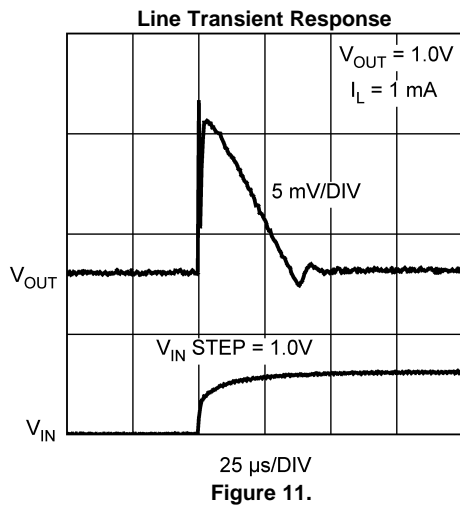

Figure 11.

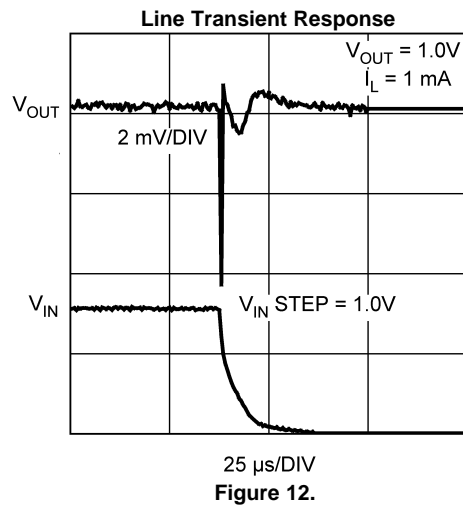

Figure 12.

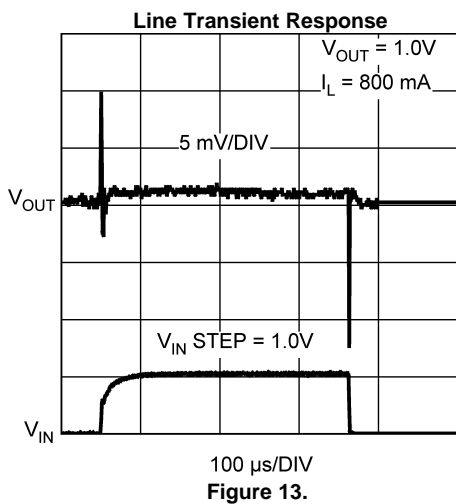

Figure 13.

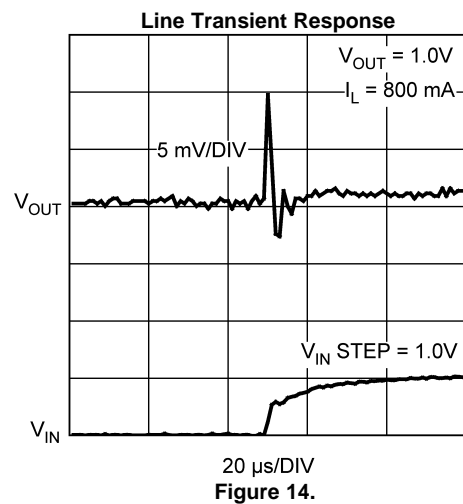

Figure 14.

Typical Performance Characteristics (continued)

Unless otherwise specified: $V_{IN} = 3.3V$, $V_{OUT} = 1V$, $I_L = 1\text{ mA}$, $C_{IN} = 4.7\text{ }\mu\text{F}$, $C_{OUT} = 10\text{ }\mu\text{F}$, $V_{S/D} = 2V$, $C_{BYP} = 10\text{ nF}$, $T_J = 25^\circ\text{C}$.

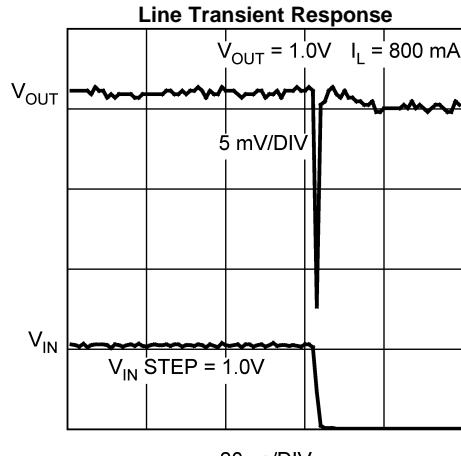

Figure 15.

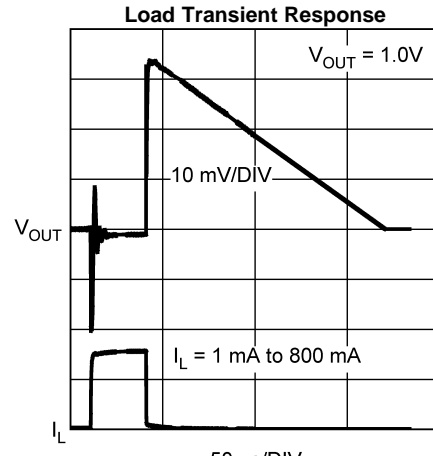

Figure 16.

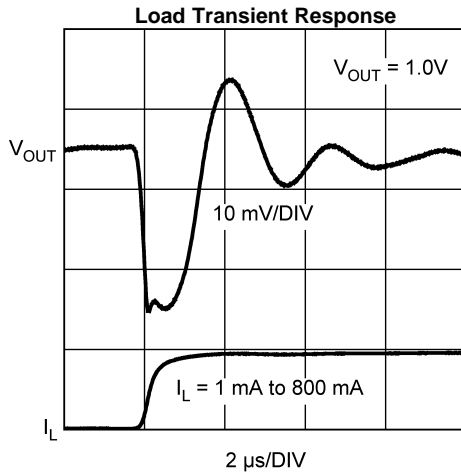

Figure 17.

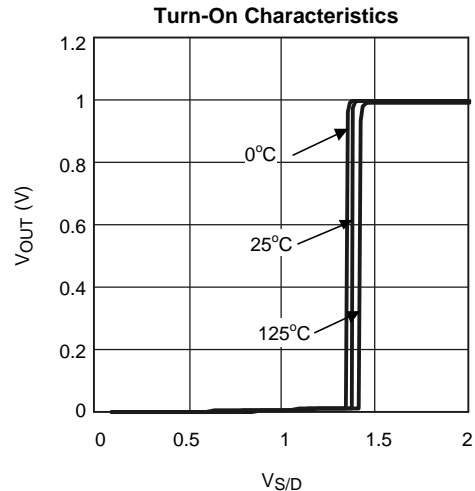
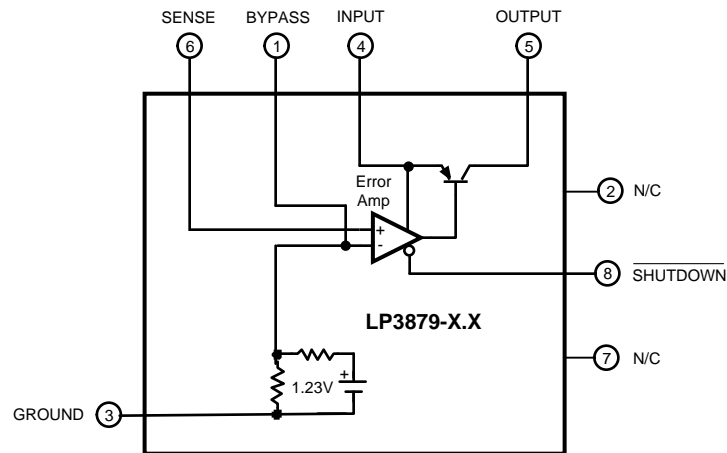

Figure 18.

Block Diagram



APPLICATION INFORMATION

PACKAGE INFORMATION

The LP3879 is offered in the 8-lead SO PowerPad or WSON surface mount packages to allow for increased power dissipation compared to the SO-8 and Mini SO-8.

EXTERNAL CAPACITORS

Like any low-dropout regulator, the LP3879 requires external capacitors for regulator stability. These capacitors must be correctly selected for good performance.

INPUT CAPACITOR: A capacitor whose value is at least 4.7 μF ($\pm 20\%$) is required between the LP3879 input and ground. A good quality X5R / X7R ceramic capacitor should be used.

Capacitor tolerance and temperature variation must be considered when selecting a capacitor (see [Capacitor Characteristics](#) section) to assure the minimum requirement of input capacitance is met over all operating conditions.

The input capacitor must be located not more than 0.5" from the input pin and returned to a clean analog ground. Any good quality ceramic or tantalum capacitor may be used, assuming the minimum input capacitance requirement is met.

OUTPUT CAPACITOR: The LP3879 requires a ceramic output capacitor whose size is at least 10 μF ($\pm 20\%$). A good quality X5R / X7R ceramic capacitor should be used. Capacitance tolerance and temperature characteristics must be considered when selecting an output capacitor.

The LP3879 is designed specifically to work with ceramic output capacitors, utilizing circuitry which allows the regulator to be stable across the entire range of output current with an ultra low ESR output capacitor.

The output capacitor selected must meet the requirement for minimum amount of capacitance and also have an ESR (equivalent series resistance) value which is within the stable range. A curve is provided which shows the stable ESR range as a function of load current (see [Figure 19](#)).

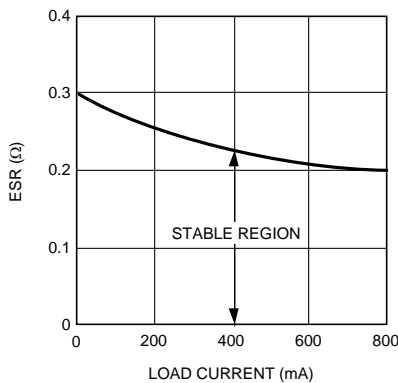

Figure 19. Stable Region For Output Capacitor ESR

Important: The output capacitor must maintain its ESR within the stable region over the full operating temperature range of the application to assure stability.

The output capacitor ESR forms a zero which is required to add phase lead near the loop gain crossover frequency, typically in the range of 50kHz to 200 kHz. The ESR at lower frequencies is of no importance. Some capacitor manufacturers list ESR at low frequencies only, and some give a formula for Dissipation Factor which can be used to calculate a value for a term referred to as ESR. However, since the DF formula is usually at a much lower frequency than the range listed above, it will give an unrealistically high value. If good quality X5R or X7R ceramic capacitors are used, the actual ESR in the 50 kHz to 200 kHz range will not exceed 25 milli Ohms. If these are used as output capacitors for the LP3879, the regulator stability requirements are satisfied.

It is important to remember that capacitor tolerance and variation with temperature must be taken into consideration when selecting an output capacitor so that the minimum required amount of output capacitance is provided over the full operating temperature range. (See [Capacitor Characteristics](#) section).

The output capacitor must be located not more than 0.5" from the output pin and returned to a clean analog ground.

NOISE BYPASS CAPACITOR: The 10 nF capacitor on the Bypass pin significantly reduces noise on the regulator output and is required for loop stability. However, the capacitor is connected directly to a high-impedance circuit in the bandgap reference.

Because this circuit has only a few microamperes flowing in it, any significant loading on this node will cause a change in the regulated output voltage. For this reason, DC leakage current through the noise bypass capacitor must never exceed 100 nA, and should be kept as low as possible for best output voltage accuracy.

The types of capacitors best suited for the noise bypass capacitor are ceramic and film. High-quality ceramic capacitors with either NPO or COG dielectric typically have very low leakage. 10 nF polypropylene and polycarbonate film capacitors are available in small surface-mount packages and typically have extremely low leakage current.

CAPACITOR CHARACTERISTICS

CERAMIC: The LP3879 was designed to work with ceramic capacitors on the output to take advantage of the benefits they offer: for capacitance values in the 10 μ F range, ceramics are the least expensive and also have the lowest ESR values (which makes them best for eliminating high-frequency noise). The ESR of a typical 10 μ F ceramic capacitor is in the range of 5 m Ω to 10 m Ω , which meets the ESR limits required for stability by the LP3879.

One disadvantage of ceramic capacitors is that their capacitance can vary with temperature. Many large value ceramic capacitors ($\geq 2.2 \mu$ F) are manufactured with the Z5U or Y5V temperature characteristic, which results in the capacitance dropping by more than 50% as the temperature goes from 25°C to 85°C.

Another significant problem with Z5U and Y5V dielectric devices is that the capacitance drops severely with applied voltage. A typical Z5U or Y5V capacitor can lose 60% of its rated capacitance with half of the rated voltage applied to it.

For these reasons, X7R and X5R type ceramic capacitors must be used on the input and output of the LP3879.

SHUTDOWN INPUT OPERATION

The LP3879 is shut off by pulling the Shutdown input low, and turned on by pulling it high. If this feature is not to be used, the Shutdown input should be tied to V_{IN} to keep the regulator output on at all times.

To assure proper operation, the signal source used to drive the Shutdown input must be able to swing above and below the specified turn-on/turn-off voltage thresholds listed in the [Electrical Characteristics](#) section under $V_{ON/OFF}$.

REVERSE INPUT-OUTPUT VOLTAGE

The PNP power transistor used as the pass element in the LP3879 has an inherent diode connected between the regulator output and input.

During normal operation (where the input voltage is higher than the output) this diode is reverse-biased.

However, if the output is pulled above the input, this diode will turn ON and current will flow into the regulator output.







In such cases, a parasitic SCR can latch which will allow a high current to flow into V_{IN} (and out the ground pin), which can damage the part.

In any application where the output may be pulled above the input, an external Schottky diode must be connected from V_{IN} to V_{OUT} (cathode on V_{IN} , anode on V_{OUT}), to limit the reverse voltage across the LP3879 to 0.3V (see [Absolute Maximum Ratings](#)).

REVISION HISTORY

Changes from Revision A (April 2013) to Revision B	Page
• Changed layout of National Data Sheet to TI format	10

PACKAGING INFORMATION

Orderable Device	Status (1)	Package Type	Package Drawing	Pins	Package Qty	Eco Plan (2)	Lead finish/ Ball material (6)	MSL Peak Temp (3)	Op Temp (°C)	Device Marking (4/5)	Samples
LP3879MR-1.0/NOPB	ACTIVE	SO PowerPAD	DDA	8	95	RoHS & Green	SN	Level-3-260C-168 HR	-40 to 125	3879 MR1.0	
LP3879MR-1.2	NRND	SO PowerPAD	DDA	8	95	Non-RoHS & Green	Call TI	Level-3-260C-168 HR		LP3879 MR1.2	
LP3879MR-1.2/NOPB	ACTIVE	SO PowerPAD	DDA	8	95	RoHS & Green	SN	Level-3-260C-168 HR	-40 to 125	LP3879 MR1.2	
LP3879MRX-1.0/NOPB	ACTIVE	SO PowerPAD	DDA	8	2500	RoHS & Green	SN	Level-3-260C-168 HR	-40 to 125	3879 MR1.0	
LP3879MRX-1.2/NOPB	ACTIVE	SO PowerPAD	DDA	8	2500	RoHS & Green	SN	Level-3-260C-168 HR	-40 to 125	LP3879 MR1.2	
LP3879SD-1.0/NOPB	ACTIVE	WSON	NGT	8	1000	RoHS & Green	SN	Level-1-260C-UNLIM	-40 to 125	79SD1.0	
LP3879SD-1.2/NOPB	ACTIVE	WSON	NGT	8	1000	RoHS & Green	SN	Level-1-260C-UNLIM	-40 to 125	79SD1.2	

(1) The marketing status values are defined as follows:

ACTIVE: Product device recommended for new designs.

LIFEBUY: TI has announced that the device will be discontinued, and a lifetime-buy period is in effect.

NRND: Not recommended for new designs. Device is in production to support existing customers, but TI does not recommend using this part in a new design.

PREVIEW: Device has been announced but is not in production. Samples may or may not be available.

OBSELETE: TI has discontinued the production of the device.

(2) **RoHS:** TI defines "RoHS" to mean semiconductor products that are compliant with the current EU RoHS requirements for all 10 RoHS substances, including the requirement that RoHS substance do not exceed 0.1% by weight in homogeneous materials. Where designed to be soldered at high temperatures, "RoHS" products are suitable for use in specified lead-free processes. TI may reference these types of products as "Pb-Free".

RoHS Exempt: TI defines "RoHS Exempt" to mean products that contain lead but are compliant with EU RoHS pursuant to a specific EU RoHS exemption.

Green: TI defines "Green" to mean the content of Chlorine (Cl) and Bromine (Br) based flame retardants meet JS709B low halogen requirements of <=1000ppm threshold. Antimony trioxide based flame retardants must also meet the <=1000ppm threshold requirement.

(3) MSL, Peak Temp. - The Moisture Sensitivity Level rating according to the JEDEC industry standard classifications, and peak solder temperature.

(4) There may be additional marking, which relates to the logo, the lot trace code information, or the environmental category on the device.

(5) Multiple Device Markings will be inside parentheses. Only one Device Marking contained in parentheses and separated by a "~" will appear on a device. If a line is indented then it is a continuation of the previous line and the two combined represent the entire Device Marking for that device.

⁽⁶⁾ Lead finish/Ball material - Orderable Devices may have multiple material finish options. Finish options are separated by a vertical ruled line. Lead finish/Ball material values may wrap to two lines if the finish value exceeds the maximum column width.

Important Information and Disclaimer: The information provided on this page represents TI's knowledge and belief as of the date that it is provided. TI bases its knowledge and belief on information provided by third parties, and makes no representation or warranty as to the accuracy of such information. Efforts are underway to better integrate information from third parties. TI has taken and continues to take reasonable steps to provide representative and accurate information but may not have conducted destructive testing or chemical analysis on incoming materials and chemicals. TI and TI suppliers consider certain information to be proprietary, and thus CAS numbers and other limited information may not be available for release.

In no event shall TI's liability arising out of such information exceed the total purchase price of the TI part(s) at issue in this document sold by TI to Customer on an annual basis.

TAPE AND REEL INFORMATION

QUADRANT ASSIGNMENTS FOR PIN 1 ORIENTATION IN TAPE

*All dimensions are nominal

Device	Package Type	Package Drawing	Pins	SPQ	Reel Diameter (mm)	Reel Width W1 (mm)	A0 (mm)	B0 (mm)	K0 (mm)	P1 (mm)	W (mm)	Pin1 Quadrant
LP3879MRX-1.0/NOPB	SO PowerPAD	DDA	8	2500	330.0	12.4	6.5	5.4	2.0	8.0	12.0	Q1
LP3879MRX-1.2/NOPB	SO PowerPAD	DDA	8	2500	330.0	12.4	6.5	5.4	2.0	8.0	12.0	Q1
LP3879SD-1.0/NOPB	WSON	NGT	8	1000	178.0	12.4	4.3	4.3	1.3	8.0	12.0	Q1
LP3879SD-1.2/NOPB	WSON	NGT	8	1000	178.0	12.4	4.3	4.3	1.3	8.0	12.0	Q1

TAPE AND REEL BOX DIMENSIONS



*All dimensions are nominal

Device	Package Type	Package Drawing	Pins	SPQ	Length (mm)	Width (mm)	Height (mm)
LP3879MRX-1.0/NOPB	SO PowerPAD	DDA	8	2500	356.0	356.0	35.0
LP3879MRX-1.2/NOPB	SO PowerPAD	DDA	8	2500	356.0	356.0	35.0
LP3879SD-1.0/NOPB	WSON	NGT	8	1000	208.0	191.0	35.0
LP3879SD-1.2/NOPB	WSON	NGT	8	1000	208.0	191.0	35.0

TUBE

*All dimensions are nominal

Device	Package Name	Package Type	Pins	SPQ	L (mm)	W (mm)	T (μm)	B (mm)
LP3879MR-1.0/NOPB	DDA	HSOIC	8	95	495	8	4064	3.05
LP3879MR-1.0/NOPB	DDA	HSOIC	8	95	495	8	4064	3.05
LP3879MR-1.2	DDA	HSOIC	8	95	495	8	4064	3.05
LP3879MR-1.2	DDA	HSOIC	8	95	495	8	4064	3.05
LP3879MR-1.2/NOPB	DDA	HSOIC	8	95	495	8	4064	3.05

DDA0008B



PACKAGE OUTLINE

PowerPAD™ SOIC - 1.7 mm max height

PLASTIC SMALL OUTLINE

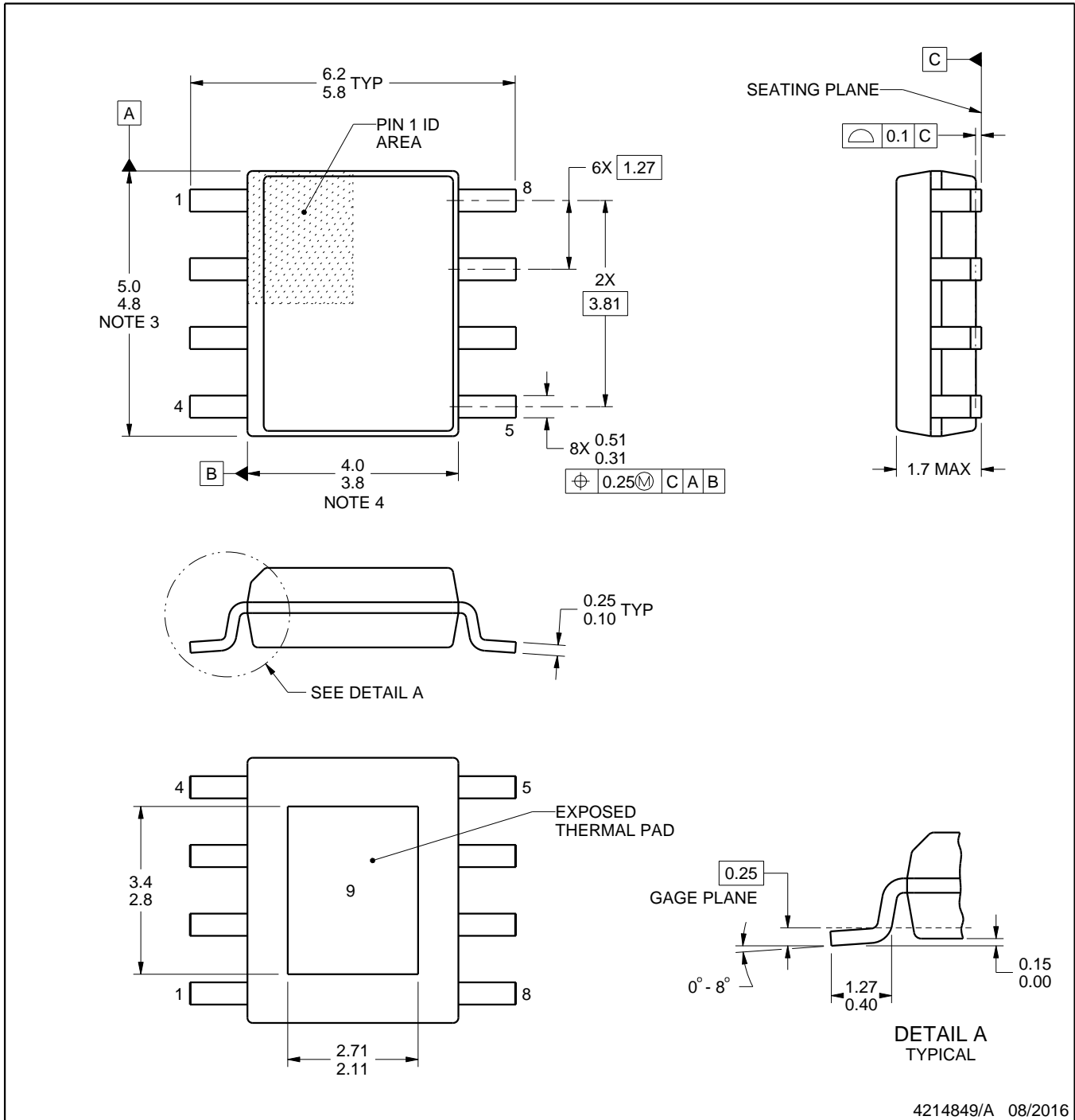

PowerPAD is a trademark of Texas Instruments.

NOTES:

1. All linear dimensions are in millimeters. Any dimensions in parenthesis are for reference only. Dimensioning and tolerancing per ASME Y14.5M.
2. This drawing is subject to change without notice.
3. This dimension does not include mold flash, protrusions, or gate burrs. Mold flash, protrusions, or gate burrs shall not exceed 0.15 mm per side.
4. This dimension does not include interlead flash. Interlead flash shall not exceed 0.25 mm per side.
5. Reference JEDEC registration MS-012.

EXAMPLE BOARD LAYOUT

DDA0008B

PowerPAD™ SOIC - 1.7 mm max height

PLASTIC SMALL OUTLINE

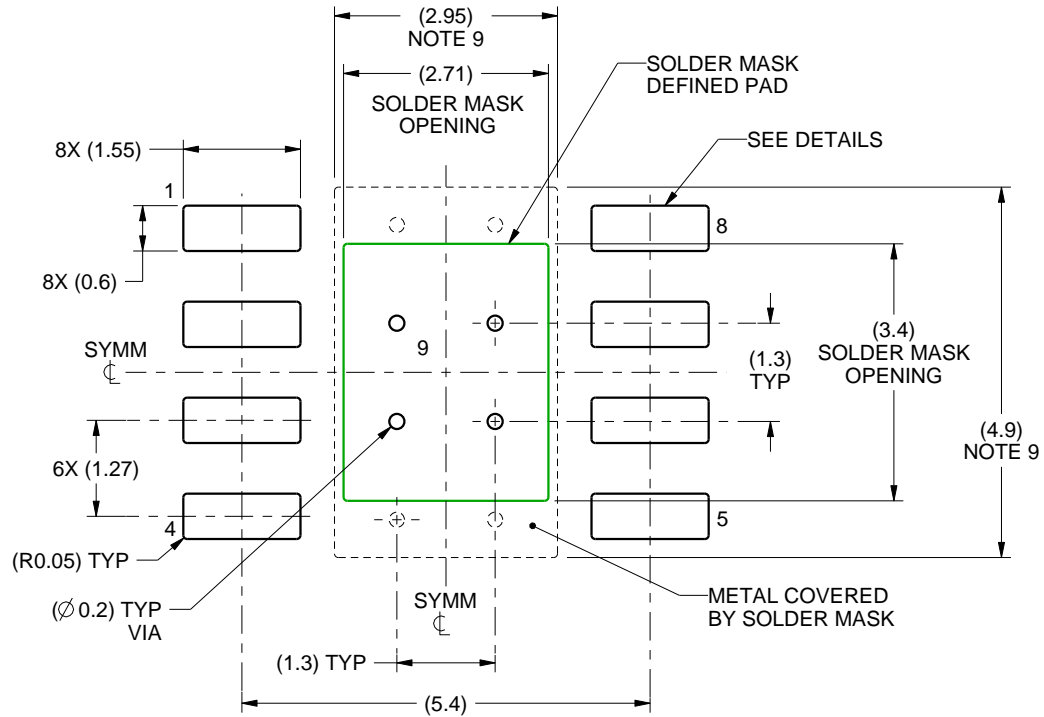

LAND PATTERN EXAMPLE
SCALE:10X

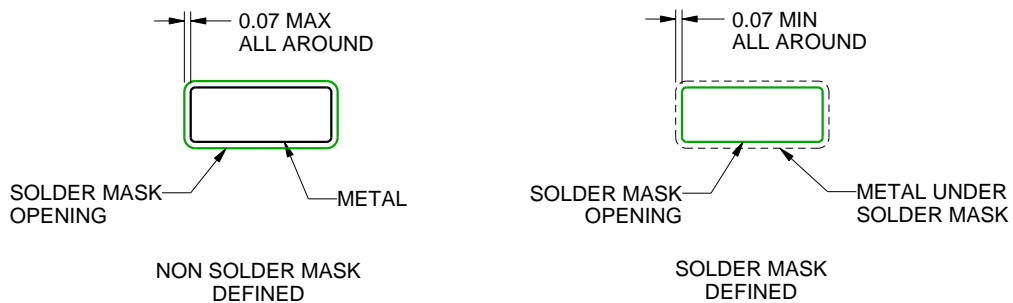

SOLDER MASK DETAILS
PADS 1-8

4214849/A 08/2016

NOTES: (continued)

6. Publication IPC-7351 may have alternate designs.
7. Solder mask tolerances between and around signal pads can vary based on board fabrication site.
8. This package is designed to be soldered to a thermal pad on the board. For more information, see Texas Instruments literature numbers SLMA002 (www.ti.com/lit/slma002) and SLMA004 (www.ti.com/lit/slma004).
9. Size of metal pad may vary due to creepage requirement.
10. Vias are optional depending on application, refer to device data sheet. If any vias are implemented, refer to their locations shown on this view. It is recommended that vias under paste be filled, plugged or tented.

EXAMPLE STENCIL DESIGN

DDA0008B

PowerPAD™ SOIC - 1.7 mm max height

PLASTIC SMALL OUTLINE

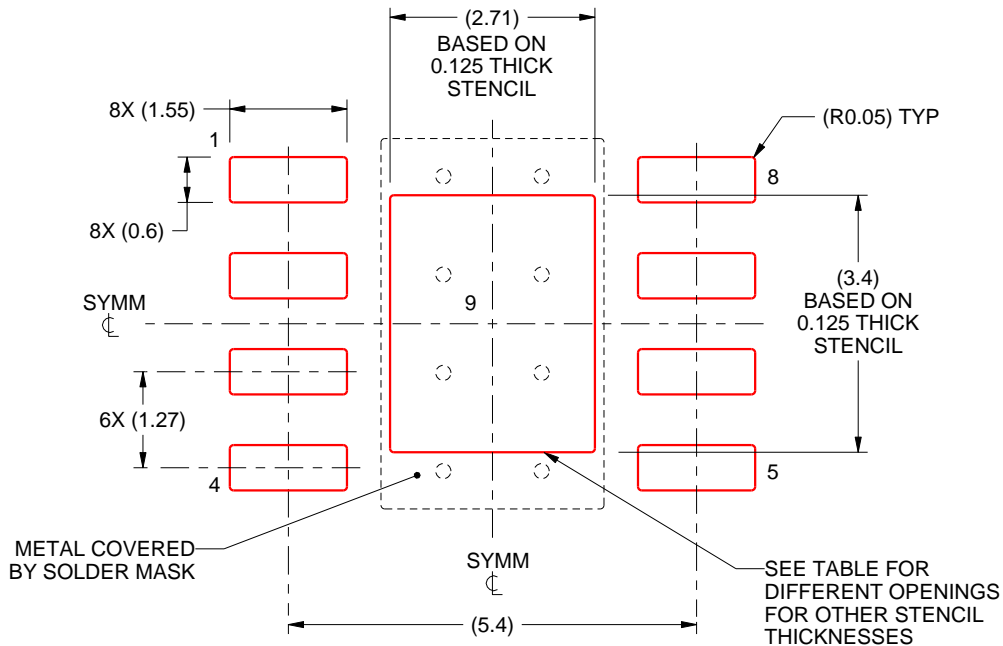

SOLDER PASTE EXAMPLE
EXPOSED PAD
100% PRINTED SOLDER COVERAGE BY AREA
SCALE:10X

STENCIL THICKNESS	SOLDER STENCIL OPENING
0.1	3.03 X 3.80
0.125	2.71 X 3.40 (SHOWN)
0.150	2.47 X 3.10
0.175	2.29 X 2.87

4214849/A 08/2016

NOTES: (continued)

11. Laser cutting apertures with trapezoidal walls and rounded corners may offer better paste release. IPC-7525 may have alternate design recommendations.
12. Board assembly site may have different recommendations for stencil design.

EXAMPLE BOARD LAYOUT

NGT0008A

WSON - 0.8 mm max height

PLASTIC SMALL OUTLINE - NO LEAD

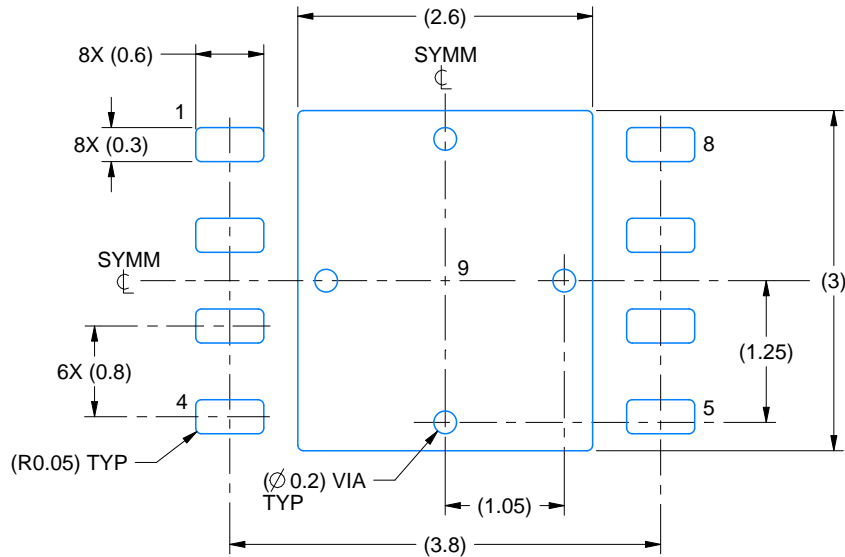

LAND PATTERN EXAMPLE
EXPOSED METAL SHOWN
SCALE:15X

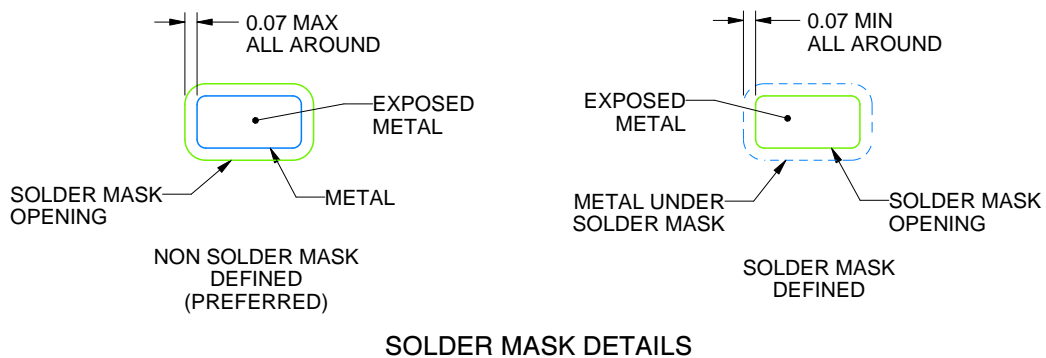

SOLDER MASK DETAILS

4214935/A 08/2020

NOTES: (continued)

4. This package is designed to be soldered to a thermal pad on the board. For more information, see Texas Instruments literature number SLUA271 (www.ti.com/lit/sluea271).
5. Vias are optional depending on application, refer to device data sheet. If any vias are implemented, refer to their locations shown on this view. It is recommended that vias under paste be filled, plugged or tented.

EXAMPLE STENCIL DESIGN

NGT0008A

WSON - 0.8 mm max height

PLASTIC SMALL OUTLINE - NO LEAD

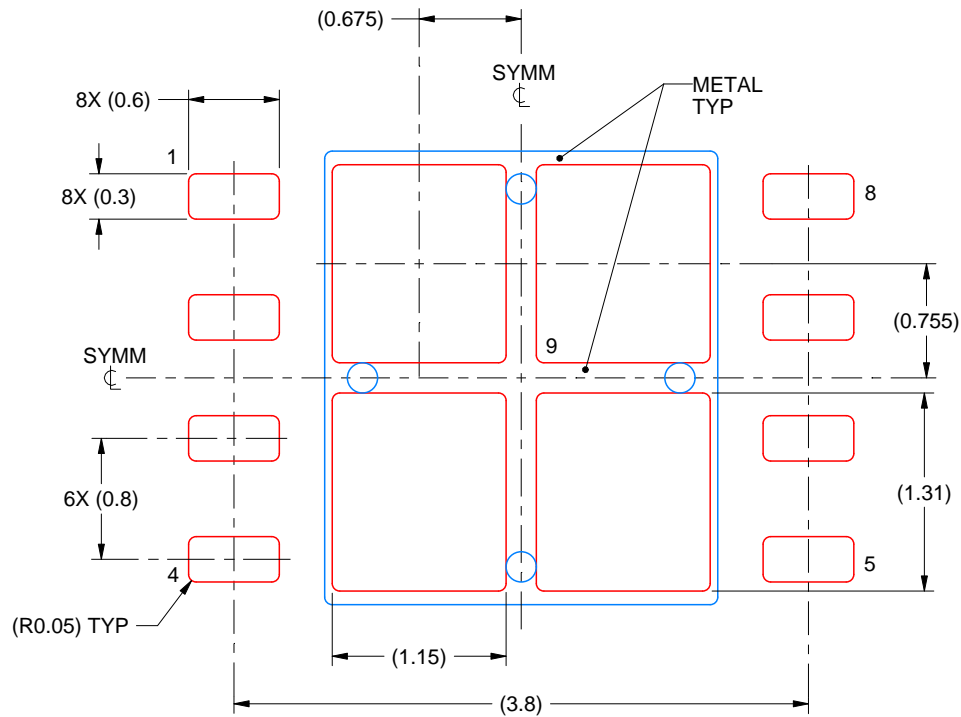

SOLDER PASTE EXAMPLE
BASED ON 0.125 mm THICK STENCIL

EXPOSED PAD 9:
77% PRINTED SOLDER COVERAGE BY AREA UNDER PACKAGE
SCALE:20X

4214935/A 08/2020

NOTES: (continued)

6. Laser cutting apertures with trapezoidal walls and rounded corners may offer better paste release. IPC-7525 may have alternate design recommendations.

IMPORTANT NOTICE AND DISCLAIMER

TI PROVIDES TECHNICAL AND RELIABILITY DATA (INCLUDING DATA SHEETS), DESIGN RESOURCES (INCLUDING REFERENCE DESIGNS), APPLICATION OR OTHER DESIGN ADVICE, WEB TOOLS, SAFETY INFORMATION, AND OTHER RESOURCES "AS IS" AND WITH ALL FAULTS, AND DISCLAIMS ALL WARRANTIES, EXPRESS AND IMPLIED, INCLUDING WITHOUT LIMITATION ANY IMPLIED WARRANTIES OF MERCHANTABILITY, FITNESS FOR A PARTICULAR PURPOSE OR NON-INFRINGEMENT OF THIRD PARTY INTELLECTUAL PROPERTY RIGHTS.

These resources are intended for skilled developers designing with TI products. You are solely responsible for (1) selecting the appropriate TI products for your application, (2) designing, validating and testing your application, and (3) ensuring your application meets applicable standards, and any other safety, security, regulatory or other requirements.

These resources are subject to change without notice. TI grants you permission to use these resources only for development of an application that uses the TI products described in the resource. Other reproduction and display of these resources is prohibited. No license is granted to any other TI intellectual property right or to any third party intellectual property right. TI disclaims responsibility for, and you will fully indemnify TI and its representatives against, any claims, damages, costs, losses, and liabilities arising out of your use of these resources.

TI's products are provided subject to [TI's Terms of Sale](#) or other applicable terms available either on ti.com or provided in conjunction with such TI products. TI's provision of these resources does not expand or otherwise alter TI's applicable warranties or warranty disclaimers for TI products.

TI objects to and rejects any additional or different terms you may have proposed.

Mailing Address: Texas Instruments, Post Office Box 655303, Dallas, Texas 75265
Copyright © 2022, Texas Instruments Incorporated

X-ON Electronics

Largest Supplier of Electrical and Electronic Components

Click to view similar products for [LDO Voltage Regulators](#) category:

Click to view products by [Texas Instruments](#) manufacturer:

Other Similar products are found below :

[NCV8664CST33T3G](#) [L79M05TL-E](#) [L9454](#) [AP7362-HA-7](#) [PT7M8202B12TA5EX](#) [TCR3DF185,LM\(CT](#) [TLF4949EJ](#) [L9708](#) [L970813TR](#)
[NCP4687DH15T1G](#) [NCV8703MX30TCG](#) [NCV4269CPD50R2G](#) [AP2111H-1.2TRG1](#) [ZLDO1117QK50TC](#) [NCP114BMX075TCG](#)
[MC33269T-3.5G](#) [TLE4471GXT](#) [NCV4266-2CST33T3G](#) [NCP715SQ15T2G](#) [NCV8623MN-50R2G](#) [NCV563SQ18T1G](#)
[NCV8664CDT33RKG](#) [NCV4299CD250R2G](#) [NCP715MX30TBG](#) [NCV8702MX25TCG](#) [L974113TR](#) [TLE7270-2E](#) [NCV562SQ25T1G](#)
[NCP715MX53TBG](#) [AP2202K-2.6TRE1](#) [NCV8170BMX300TCG](#) [NCV8152MX300180TCG](#) [NCP700CMT45TBG](#) [AP7315-33W5-7](#)
[LD56100DPU28R](#) [NCP154MX180300TAG](#) [NCV8775CDT50RKG](#) [NJM2878F3-45-TE1](#) [S-1313D18-N4T1U4](#) [AP7343D-31FS4-7B](#)
[AP7315D-33FS4-7B](#) [LD59150PUR](#) [XC6216C201MR-G](#) [XC6702D331ER-G](#) [NCP3334AMTADJTBG](#) [NCV59745AMW100TAG](#)
[NCV59745AMW1015TAG](#) [NCV8130BMX080TCG](#) [NCV8177AMTW280TCG](#) [NCV8711BMTWADJTBG](#)