



868 & 915 MHz ISM Band Antenna

PN: L001035-01

L0010305-01 ISM antennas are ideal for low-power, wide-area (LPWA) applications such as LoRaWAN®, Sigfox® and Wi-Fi HaLow™ as well as other sub-1 GHz unlicensed spectrum applications.

They offer high performance in a compact and rugged housing with a direct to device SMA Male connector for ease of installation.

FEATURES

- 868MHz & 915MHz single band antenna
- External chassis mounting antenna
- RoHS compliant
- Best performance on 90mmx150mm ground plane length

APPLICATIONS

- ISM
- LPWA / LPWAN
- LoRaWAN
- Wi-Fi HaLow

Specifications

ELECTRICAL	
Part Number	L001035-01
Frequency Range (MHz)	863-920
VSWR	< 1.9:1
Efficiency	67%
Average Gain	-1.7dBi
Peak Gain	1.2dBi
Power Handling	10 Watt
Feed Point Impedance	50Ω
Polarization	Linear
Size	863-920

MECHANICAL

Size - mm (in.)	50.5 x \varnothing 8.0 (1.99 x \varnothing 0.31)
Weight - g (lbs.)	5.8 (0.01)
Mounting	SMA Male (MIL-STD-348B)

ENVIRONMENTAL

Operating Temperature	-30 to +75°C
Storage Temperature	-30 to +75°C
Salt Spray	48 hour tested without failure
Hazardous Materials	Certificate of conformance available on TE.com product page

RF Performance

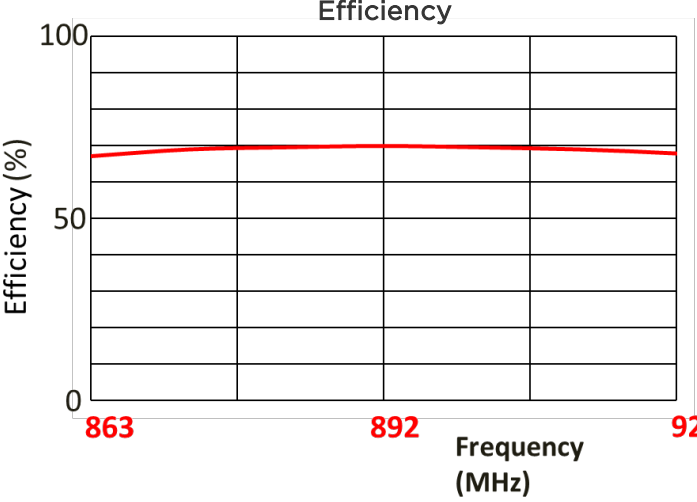
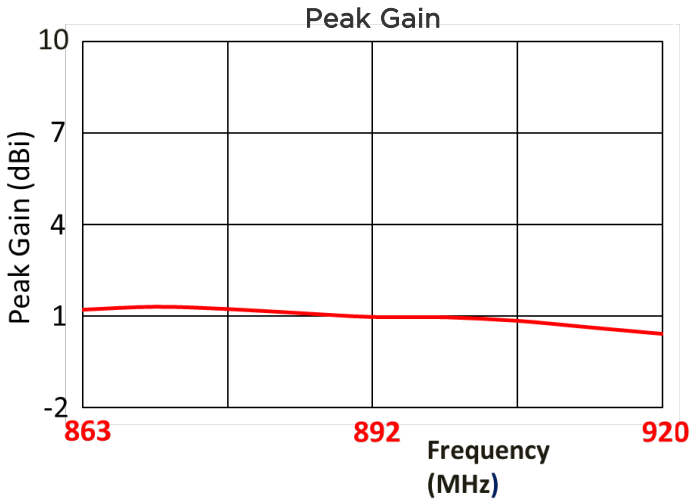
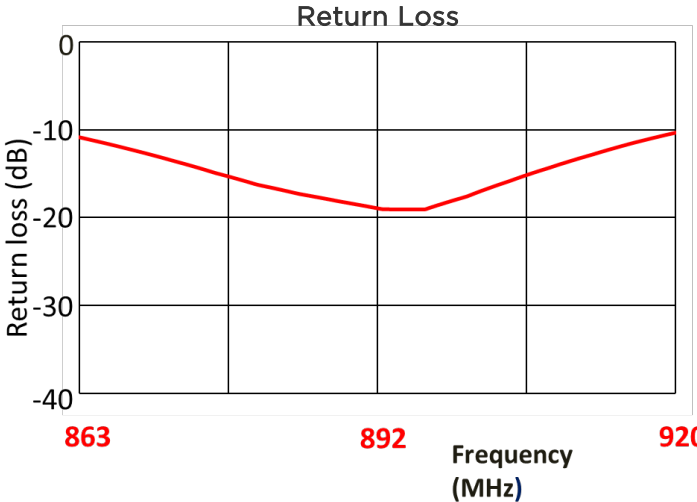
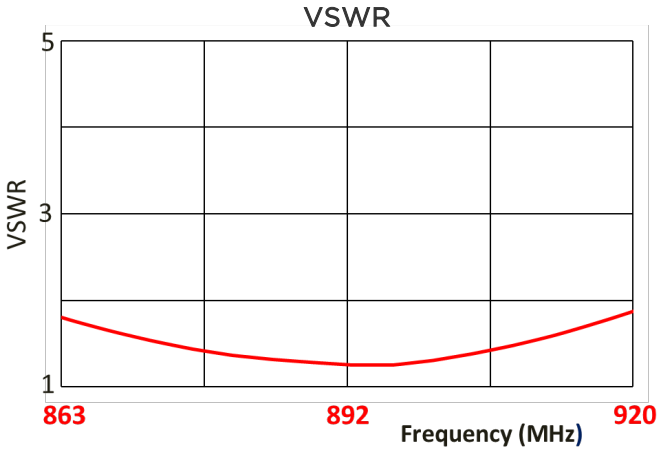

Radiation Patterns

Test Setup

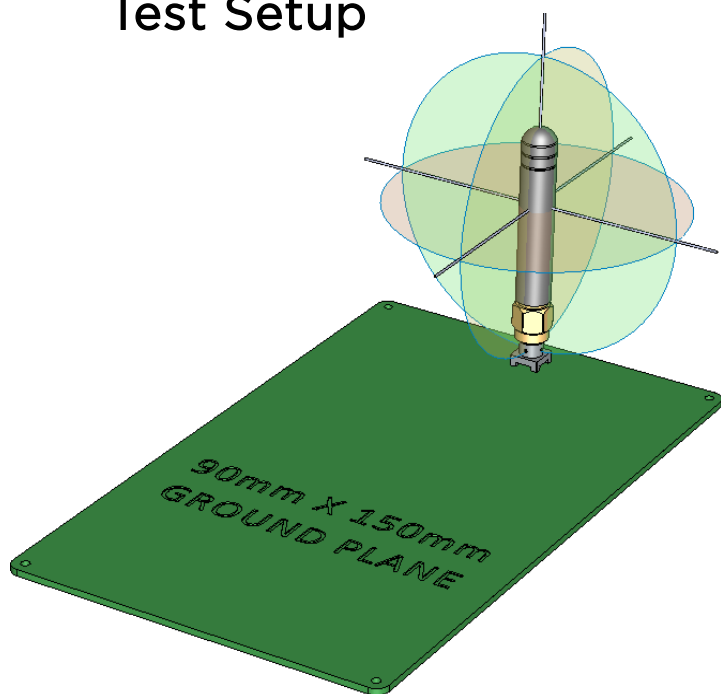

Azimuth

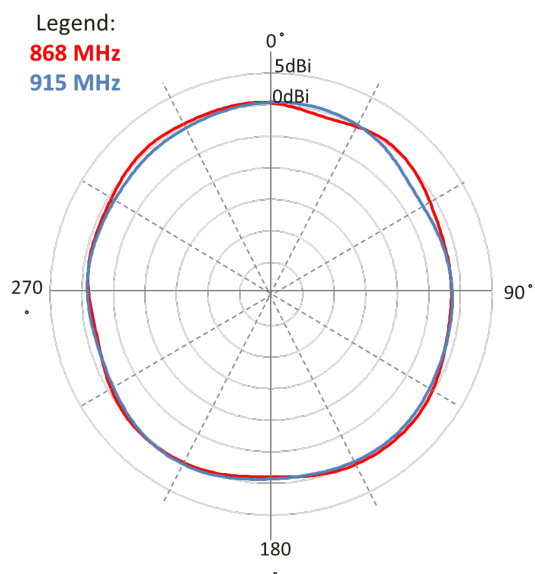

Elevation Y,Z

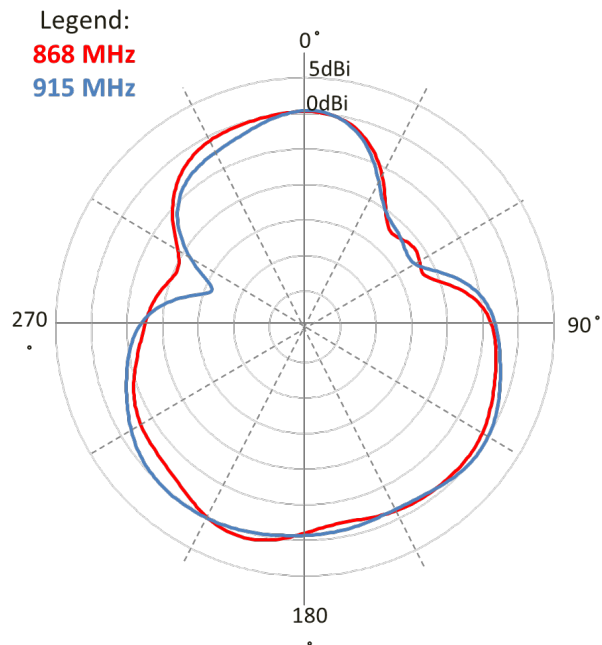

Elevation X,Z

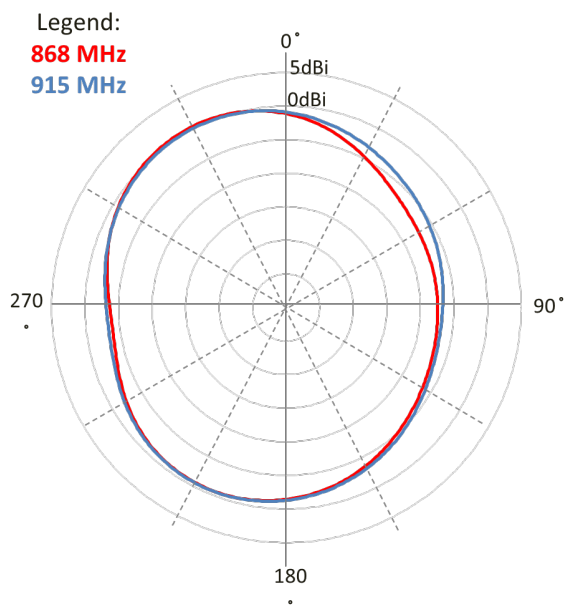

Mechanical Drawings

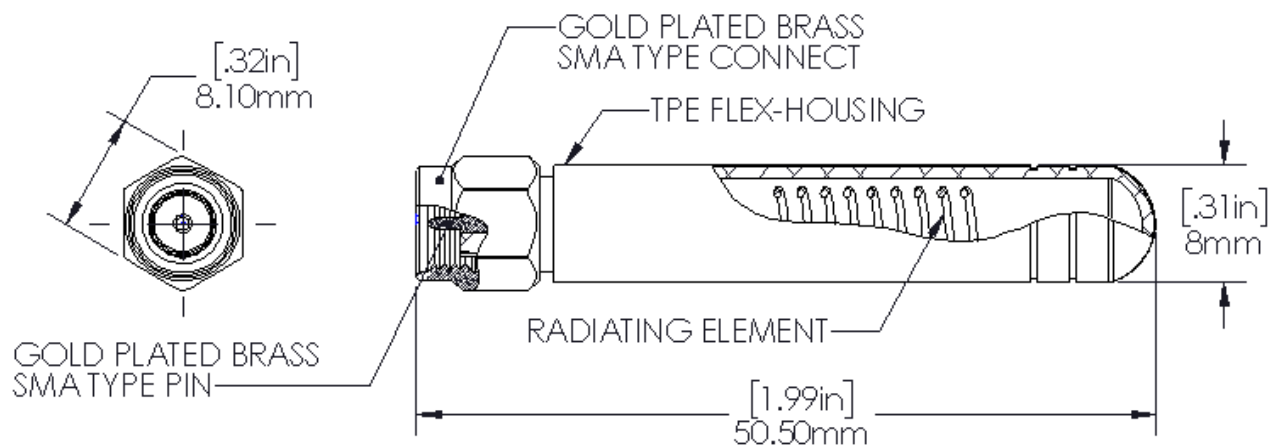

INTERFACE:

- SMA TYPE IAW MIL-STD-348B
- INTERCONNECT CYCLE 500 MINIMUM

ENVIRONMENTAL:

- 48hr SALT SPRAY TESTED WITHOUT FAILURE

PACKING INFORMATION

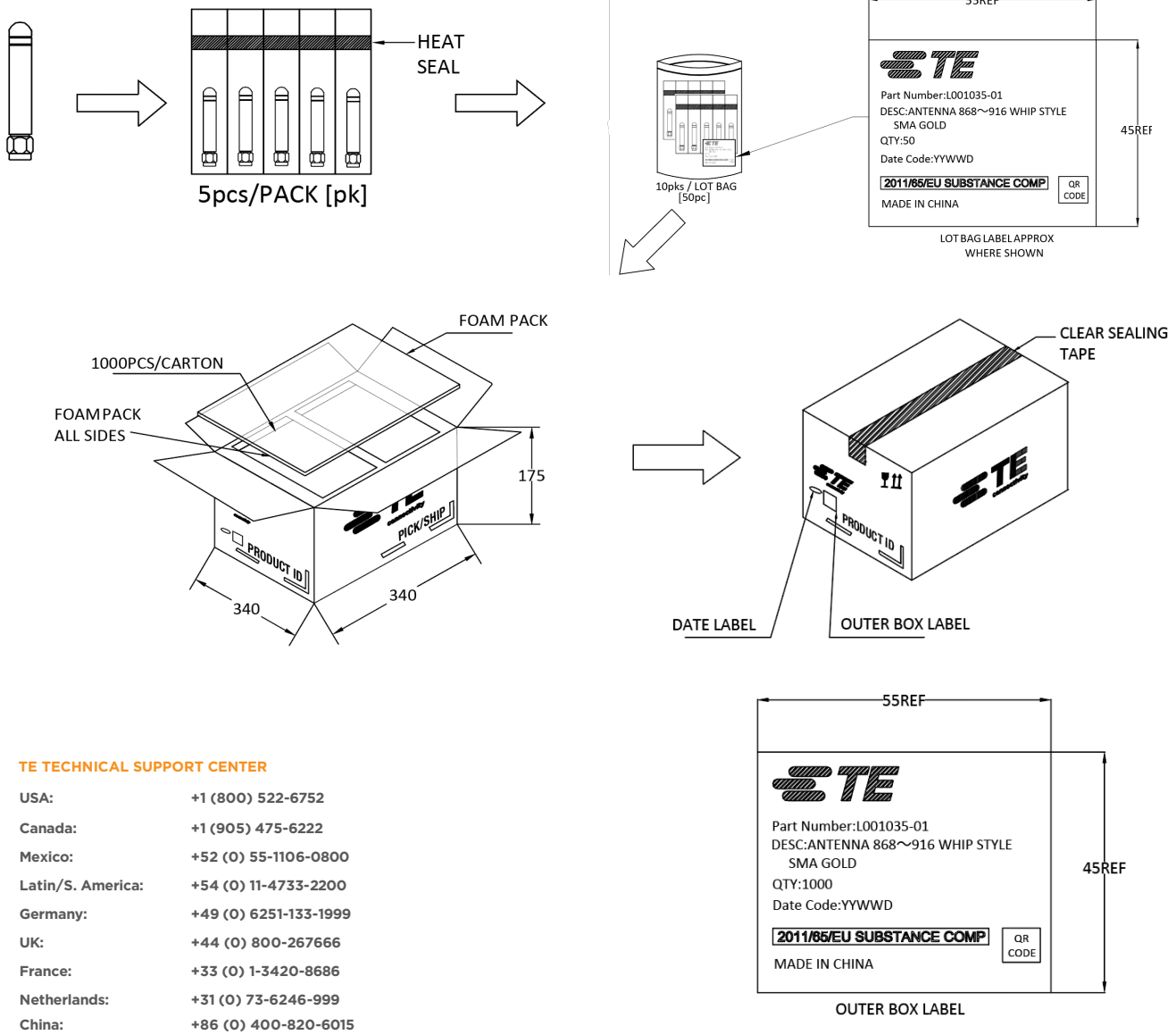

TE TECHNICAL SUPPORT CENTER

USA:	+1 (800) 522-6752
Canada:	+1 (905) 475-6222
Mexico:	+52 (0) 55-1106-0800
Latin/S. America:	+54 (0) 11-4733-2200
Germany:	+49 (0) 6251-133-1999
UK:	+44 (0) 800-267666
France:	+33 (0) 1-3420-8686
Netherlands:	+31 (0) 73-6246-999
China:	+86 (0) 400-820-6015

te.com

TE, and TE connectivity (logo) are trademarks owned or licensed by the TE Connectivity Ltd. family of companies. All other logos, products and/or company names referred to herein might be trademarks of their respective owners.

The information given herein, including drawings, illustrations and schematics which are intended for illustration purposes only, is believed to be reliable. However, TE Connectivity makes no warranties as to its accuracy or completeness and disclaims any liability in connection with its use. TE Connectivity's obligations shall only be as set forth in TE Connectivity's Standard Terms and Conditions of Sale for this product and in no case will TE Connectivity be liable for any incidental, indirect or consequential damages arising out of the sale, resale, use or misuse of the product. Users of TE Connectivity products should make their own evaluation to determine the suitability of each such product for the specific application.

TE Connectivity warrants to the original end user customer of its products that its products are free from defects in material and workmanship. Subject to conditions and limitations TE Connectivity will, at its option, either repair or replace any part of its products that prove defective because of improper workmanship or materials. This limited warranty is in force for the useful lifetime of the original end product into which the TE Connectivity product is installed. Useful lifetime of the original end product may vary but is not to exceed one (1) year from the original date of the end product purchase.

©2024 TE Connectivity. All Rights Reserved.

09/24 Original

X-ON Electronics

Largest Supplier of Electrical and Electronic Components

Click to view similar products for [Antennas](#) category:

Click to view products by [TE Connectivity](#) manufacturer:

Other Similar products are found below :

[930-033-R](#) [108-00014-50](#) [66089-2406](#) [A09-F8NF-M](#) [RGFRA1903041A1T](#) [108-00016-050](#) [W1049B090](#) [WTL2449CQ1-FRSMM](#) [CPL9C](#)
[0600-00060](#) [PAL90209H-FNF](#) [GD53-25](#) [S9025PLSMF](#) [GPSCPMM00](#) [ANTDOM-05-01-WPM](#) [ANT-WP868SMA-Y](#) [CBNC58](#) [MD10-004](#)
[ABFT](#) [LP800NMOW](#) [NMOQ88C](#) [NMOQB](#) [NMOQC](#) [ANT-GSMGPSUKS](#) [60210](#) [60140](#) [ANT-8WPIG-UFL](#) [ANT-GPSUKS](#) [A21H0](#)
[29000863](#) [29000848](#) [955179003](#) [22100003](#) [DL-T022-2.4G](#) [DL-T023-4G](#) [T1-915M](#) [DL-T021-2.4GW](#) [DL-T021-2.4G](#) [KH-IPEX-1.13](#)
[BWGNSCNX16-6B1Y2L120](#) [BWGNSCNX15-15B1Y4L120](#) [DL-T023-4GW](#) [J008-GSM](#) [3N0401LG-021](#) [KHA\(RG1.13\)-TX90B-IPEX](#) [KH-](#)
[GPS181804-WY](#) [KHA\(RG1.13\)-TX80B-IPEX](#) [TX5800-JZ-5](#) [KH-137-TX90B-IPEX4](#) [KH-113-TX100B-IPEX4](#)