





617-5000 MHZ VDP 5G/LTE CELLULAR, NB-IOT, CAT-M WIDEBAND FPC ANTENNAS

FEATURES & BENEFITS

- North America Cellular world band coverage 617-5000 MHz for 5G, LTE, NB-IoT and Cat-M
- Dimensions: 110mm x 15.5mm
- Adhesive backing on the FPC simplifies mounting within the device
- Different cable length and connector options available
- RoHS 2.0 Compliant, REACH Compliant

MATING COMPONENTS TO PART NUMBERS AND DIMENSIONS

PART NUMBER	CABLE LENGTH		CABLE O.D, MM	CONNECTOR TYPE (ON CABLE)	MATING COMPONENTS	
	MM	INCH			PART NUMBER	IMAGE
L000941-01	50	1.968	1.13	MHF-TYPE PLUG	RECEPTACLE (TE PN: 2337019-1)	
L000941-02	100.0	3.937	1.13	MHF-TYPE PLUG	RECEPTACLE (TE PN: 2337019-1)	
L000941-03	150.0	5.905	1.13	MHF-TYPE PLUG	RECEPTACLE (TE PN: 2337019-1)	
L000941-04	200.0	7.874	1.13	MHF-TYPE PLUG	RECEPTACLE (TE PN: 2337019-1)	
L000941-05	250.0	9.842	1.13	MHF-TYPE PLUG	RECEPTACLE (TE PN: 2337019-1)	
L000941-06	300.0	11.811	1.13	MHF-TYPE PLUG	RECEPTACLE (TE PN: 2337019-1)	
L000941-07	50.0	1.968	1.13	MHF4L-TYPE PLUG	RECEPTACLE (TE PN: 2334884-1)	
L000941-08	100.0	3.937	1.13	MHF4L-TYPE PLUG	RECEPTACLE (TE PN: 2334884-1)	
L000941-09	150.0	5.905	1.13	MHF4L-TYPE PLUG	RECEPTACLE (TE PN: 2334884-1)	
L000941-10	200.0	7.874	1.13	MHF4L-TYPE PLUG	RECEPTACLE (TE PN: 2334884-1)	
L000941-11	250.0	9.842	1.13	MHF4L-TYPE PLUG	RECEPTACLE (TE PN: 2334884-1)	
L000941-12	300.0	11.811	1.13	MHF4L-TYPE PLUG	RECEPTACLE (TE PN: 2334884-1)	

617-5000 MHZ VDP 5G/LTE CELLULAR, NB-IOT, CAT-M WIDEBAND FPC ANTENNAS

Standard Antenna Solutions

SPECIFICATIONS

Power Handling	10 Watt cw
Feed Point Impedance	50 ohms
Polarization	Linear
Size	110.0 mm x 15.5 mm x 0.15 mm (FPCB + adhesive) (with cable solder)
Weight	< 2.0 g
Mounting	Adhesive Tape
Mating Connectors	MHF and MHF4L type, Refer to page 12
Cable	1.13mm Dia., Refer to page 12
Operating Temperature	-40 to +85°C
Storage Temperature	-40 to +85°C
Hazardous Materials	A certificate of conformance is available from the product page on TE website

ANTENNA RF SPECIFICATIONS WITH DIFFERENT CABLE ASSEMBLIES

P/N	Cable Length	Connector	Cable OD	RF DATA	Frequency Range (MHz)						
					617-894	1710-2200	2305-2360	2496-2690	3300-3800	3800-4200	4400-5000
L000941-01	50 mm	MHF	1.13 mm	VSWR	< 2.3:1	< 2.6:1	< 1.8:1	< 2.6:1	< 2.3:1	< 2.1:1	< 2.2:1
				Avg. Efficiency	50 %	61 %	63 %	60 %	61 %	67%	54%
				Peak Gain (Max)	1.3 dBi	3.0 dBi	2.46dBi	2.93dBi	3.65dBi	3.95dBi	3.04dBi
				Average Gain	-2.9dB	-2.2 dB	-2.0 dB	-2.2 dB	-2.2 dB	-1.8 dB	-2.7 dB
L000941-02	100 mm	MHF	1.13 mm	VSWR	< 2.7:1	< 2.1:1	< 1.3:1	< 2.6:1	< 2.5:1	< 2.0:1	< 2.4:1
				Avg. Efficiency	43 %	58 %	65 %	57 %	59 %	62 %	50 %
				Peak Gain (Max)	0.3 dBi	3.0 dBi	3.5 dBi	1.6 dBi	3.3 dBi	2.7 dBi	1.5 dBi
				Average Gain	-3.7 dB	-2.4 dB	-1.9 dB	-2.5 dB	-2.3 dB	-2.1 dB	-3.1 dB
L000941-03	150 mm	MHF	1.13 mm	VSWR	<2.5 :1	< 2.1 :1	<1.6 :1	< 2.3 :1	< 2.1 :1	<2.0 :1	<2.5 :1
				Avg. Efficiency	56 %	56 %	64 %	55 %	58 %	60 %	47 %
				Peak Gain (Max)	1.29 dBi	2.8 dBi	4.33 dBi	1.56 dBi	3.76 dBi	3.72 dBi	2.45 dBi
				Average Gain	-2.56 dB	-2.49 dB	-1.9 dB	-2.6 dB	-2.37 dB	-2.22 dB	-3.32 dB
L000941-04	200 mm	MHF	1.13 mm	VSWR	< 1.8 :1	< 2.1 :1	< 2.2 :1	< 2.0 :1	< 2.6 :1	<2.4 :1	<2.2 :1
				Avg. Efficiency	54 %	59 %	56 %	58 %	53 %	57 %	46 %
				Peak Gain (Max)	1.15 dBi	3.32 dBi	2.87 dBi	2.5 dBi	2.88 dBi	4.1 dBi	2.24 dBi
				Average Gain	-2.64 dB	-2.27 dB	-2.46 dB	-2.37 dB	-2.74 dB	-2.44 dB	-3.4 dB

CABLE LOSS

OD 1.37mm (P/N: 2-2108921)

Freq. Range (MHz)	617-960	1427-1517	1690-2400	2496-2690	3300-3800	3800-4200	4400-5000
Cable attenuation (dB/m)	< 1.9	<2.25	< 2.75	< 3.0	<3.5	< 3.8	< 4.0

ANTENNA RF SPECIFICATIONS WITH DIFFERENT CABLE ASSEMBLIES

P/N	RF DATA	Frequency Range (MHz)						
		617-894	1710-2200	2305-2360	2496-2690	3300-3800	3800-4200	4400-5000
L000836-05	VSWR	<2.4 :1	< 1.9 :1	<1.9 :1	< 2.2 :1	< 2.1 :1	<2.0 :1	<2.1 :1
50 mm	Avg. Efficiency	46.4%	57.1 %	55 %	54.7 %	50.5 %	54.8 %	42 %
MHF	Peak Gain (Max)	1.47 dBi	3.85 dBi	3.24 dBi	3.2 dBi	3.48 dBi	5.04 dBi	2.78 dBi
1.13 mm	Average Gain	-3.3dB	-2.4dB	-2.6dB	-2.6dB	-2.9dB	-2.6dB	-3.8dB
L000836-06	VSWR	< 2.6 :1	< 2.0 :1	< 1.7 :1	< 2.2 :1	< 2.0 :1	<1.8 :1	<2.1 :1
100 mm	Avg. Efficiency	45.8%	52.9 %	57.7 %	51.4 %	48.6 %	53.4 %	40.4 %
MHF	Peak Gain (Max)	0.95 dBi	3.83 dBi	4.39 dBi	3.68 dBi	3.25 dBi	3.63 dBi	1.72 dBi
1.13 mm	Average Gain	-3.4dB	-2.7dB	-2.3dB	-2.9dB	-3.1dB	-2.7dB	-3.9dB
L000836-07	VSWR	< 2.3:1	< 2.6 :1	< 1.8:1	< 2.6:1	< 2.3:1	< 2.1:1	< 2.1:1
150 mm	Avg. Efficiency	50 %	61 %	63 %	60 %	61 %	67%	54%
MHF	Peak Gain (Max)	1.3 dBi	3.0 dBi	2.46dBi	2.93dBi	3.65dBi	3.95dBi	3.04dBi
1.13 mm	Average Gain	-2.9dB	-2.2 dB	-2.0 dB	-2.2 dB	-2.2 dB	-1.8 dB	-2.7 dB
L000836-08	VSWR	< 2.7 :1	< 2.1:1	< 1.3:1	< 2.6:1	< 2.5:1	< 2.0:1	< 2.4:1
200 mm	Avg. Efficiency	43 %	58 %	65 %	57 %	59 %	62 %	50 %
MHF	Peak Gain (Max)	0.3 dBi	3.0 dBi	3.5 dBi	1.6 dBi	3.3 dBi	2.7 dBi	1.5 dBi
1.13 mm	Average Gain	-3.7 dB	-2.4 dB	-1.9 dB	-2.5 dB	-2.3 dB	-2.1 dB	-3.1 dB

CABLE LOSS

OD 1.37mm (P/N: 2-2108921)

Freq. Range (MHz)	617-960	1427-1517	1690-2400	2496-2690	3300-3800	3800-4200	4400-5000
Cable attenuation (dB/m)	< 1.9	<2.25	< 2.75	< 3.0	<3.5	< 3.8	< 4.0

ANTENNA RF SPECIFICATIONS WITH DIFFERENT CABLE ASSEMBLIES

P/N	RF DATA	Frequency Range (MHz)						
		617-894	1710-2200	2305-2360	2496-2690	3300-3800	3800-4200	4400-5000
L000941-09	VSWR	<2.5 :1	< 2.1 :1	<1.6 :1	< 2.3 :1	< 2.1 :1	<2.0 :1	<2.5 :1
150 mm	Avg. Efficiency	56 %	56 %	64 %	55 %	58 %	60 %	47 %
MHF4L	Peak Gain (Max)	1.29 dBi	2.8 dBi	4.33 dBi	1.56 dBi	3.76 dBi	3.72 dBi	2.45 dBi
1.13 mm	Average Gain	-2.56 dB	-2.49 dB	-1.9 dB	-2.6 dB	-2.37 dB	-2.22 dB	-3.32 dB
L000941-10	VSWR	< 1.8 :1	< 2.1 :1	< 2.2 :1	< 2.0 :1	< 2.6 :1	<2.4 :1	<2.2 :1
200 mm	Avg. Efficiency	54 %	59 %	56 %	58 %	53 %	57 %	46 %
MHF4L	Peak Gain (Max)	1.15 dBi	3.32 dBi	2.87 dBi	2.5 dBi	2.88 dBi	4.1 dBi	2.24 dBi
1.13 mm	Average Gain	-2.64 dB	-2.27 dB	-2.46 dB	-2.37 dB	-2.74 dB	-2.44 dB	-3.4 dB
L000941-11	VSWR	<2.4 :1	< 1.9 :1	<1.9 :1	< 2.2 :1	< 2.1 :1	<2.0 :1	<2.1 :1
150 mm	Avg. Efficiency	46.4%	57.1 %	55 %	54.7 %	50.5 %	54.8 %	42 %
MHF4L	Peak Gain (Max)	1.47 dBi	3.85 dBi	3.24 dBi	3.2 dBi	3.48 dBi	5.04 dBi	2.78 dBi
1.13 mm	Average Gain	-3.3dB	-2.4dB	-2.6dB	-2.6 dB	-2.9dB	-2.6dB	-3.8dB
L000941-12	VSWR	< 2.6 :1	< 2.0 :1	< 1.7 :1	< 2.2 :1	< 2.0 :1	<1.8 :1	<2.1 :1
200 mm	Avg. Efficiency	45.8%	52.9 %	57.7 %	51.4 %	48.6 %	53.4 %	40.4 %
MHF4L	Peak Gain (Max)	0.95 dBi	3.83 dBi	4.39 dBi	3.68 dBi	3.25 dBi	3.63 dBi	1.72 dBi
1.13 mm	Average Gain	-3.4dB	-2.7dB	-2.3dB	-2.9dB	-3.1dB	-2.7dB	-3.9dB

CABLE LOSS

OD 1.13mm (P/N: 3-2108921)

Freq. Range (MHz)	617-960	1427-1517	1690-2400	2496-2690	3300-3800	3800-4200	4400-5000
Cable attenuation (dB/m)	< 2.2	<2.9	< 3.69	< 4.0	<4.5	< 4.7	< 5.0

RF DATA

(Shown as L000941-02 : Others can vary with different cable lengths.)

VSWR

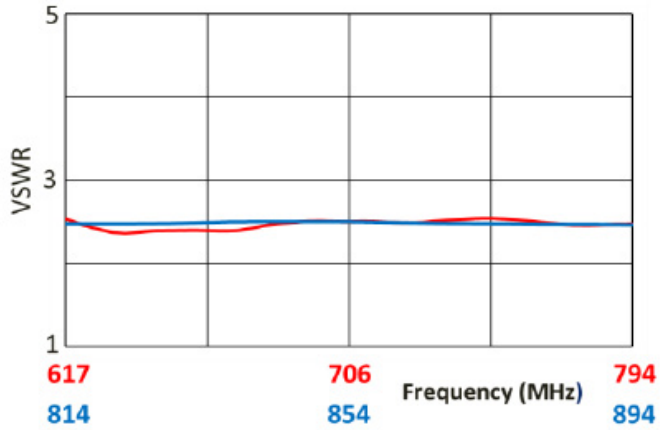

Return Loss

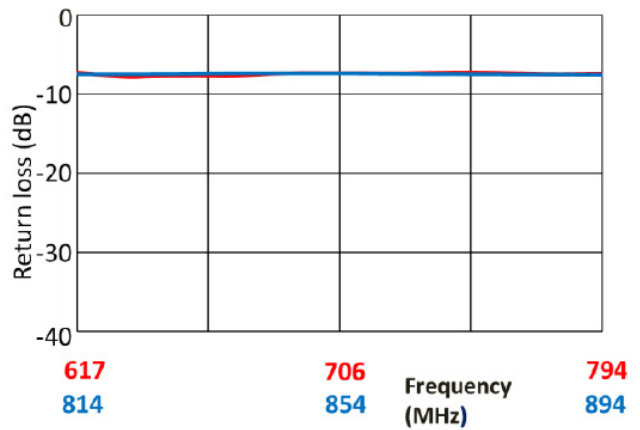

Peak Gain

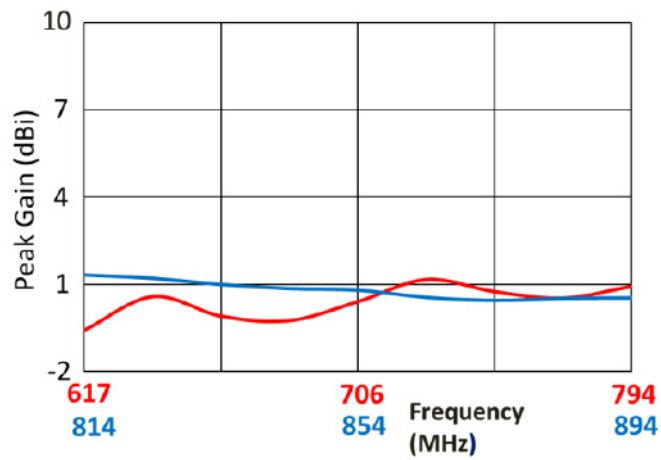

Efficiency

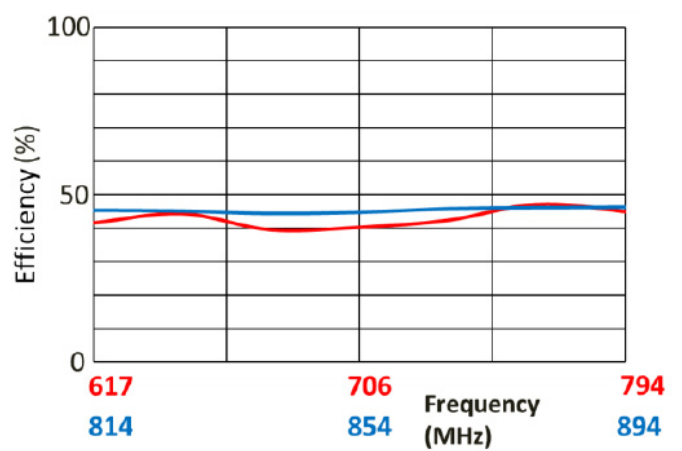

Data measured in free space and on 150 x 150 x 2.0 mm PC plastic

RF DATA

(Shown as L000941-02 : Others can vary with different cable lengths.)

VSWR

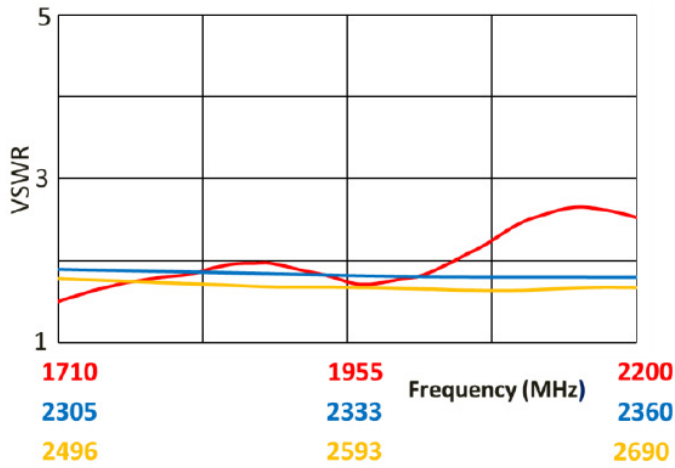

Return Loss

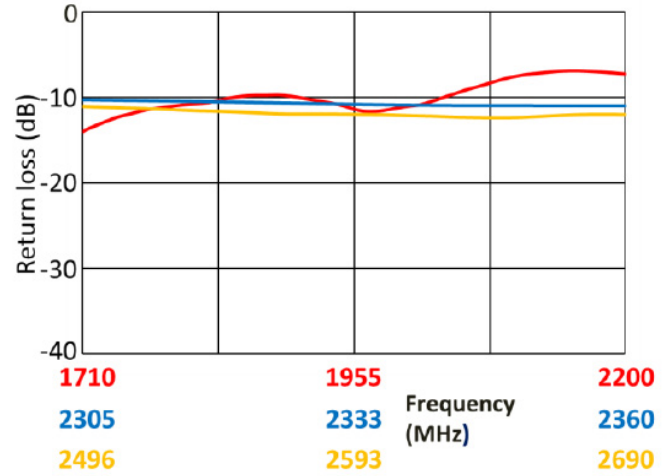

Peak Gain

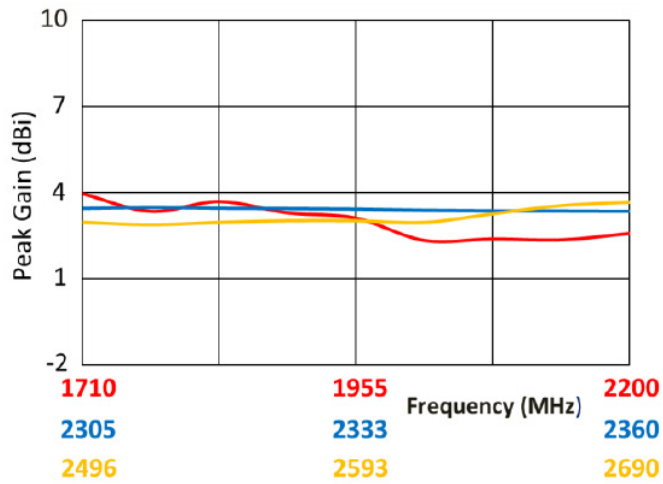

Efficiency

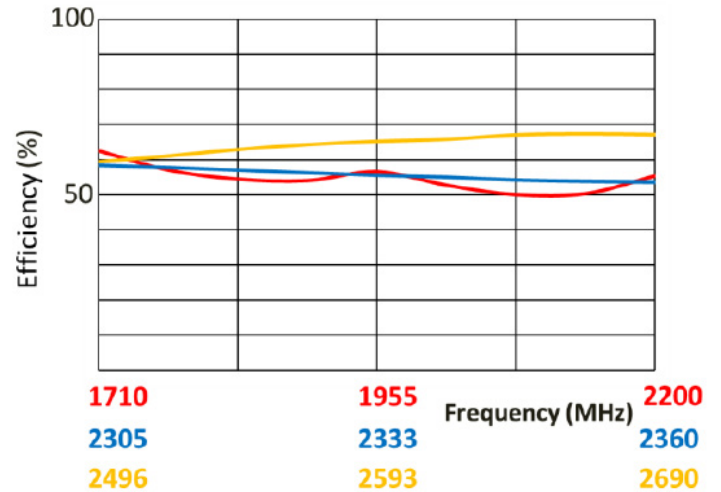

Data measured in free space and on 150 x 150 x 2.0 mm PC plastic

RF DATA

(Shown as L000941-02 : Others can vary with different cable lengths.)

VSWR

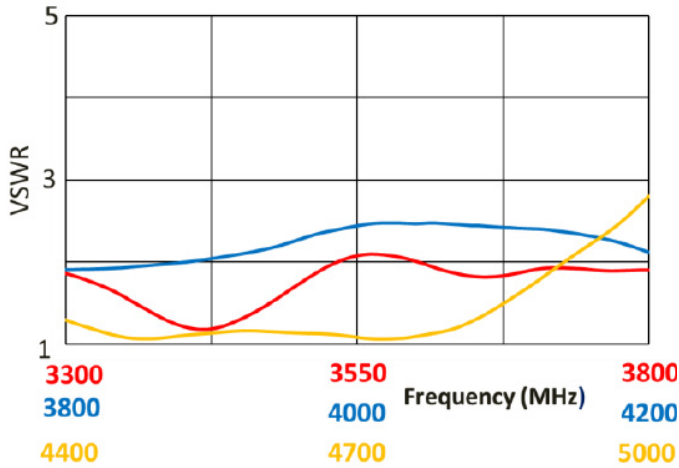

Return Loss

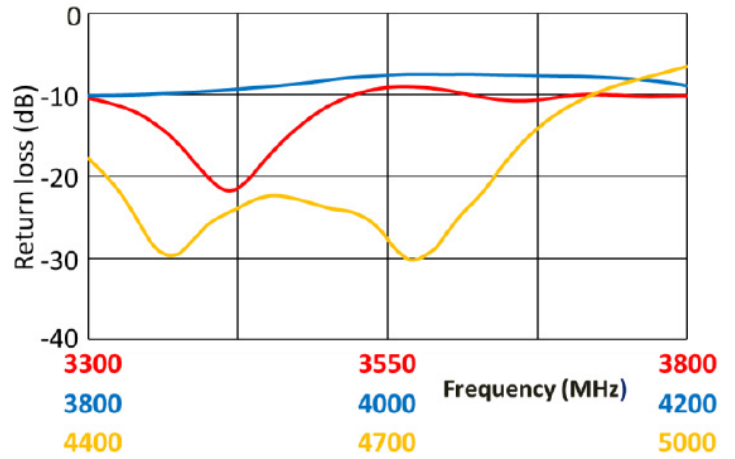

Peak Gain

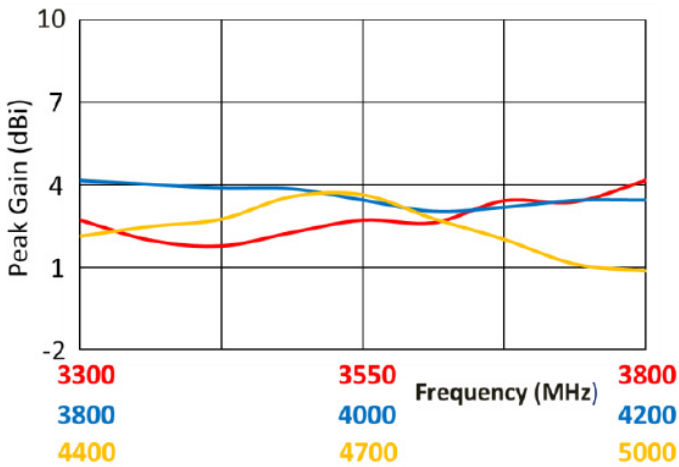

Efficiency

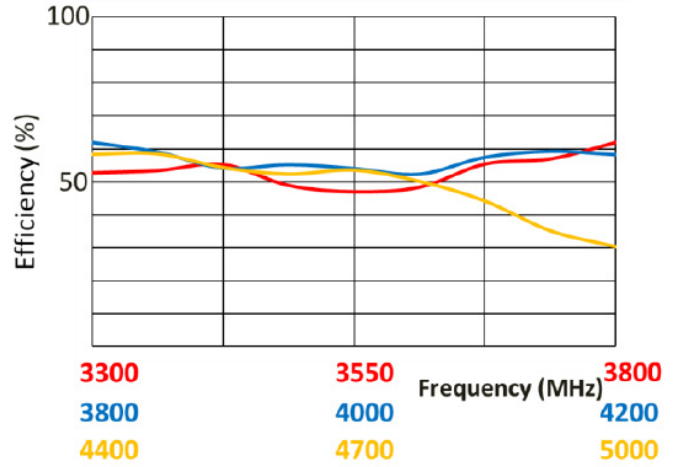

Data measured in free space and on 150 x 150 x 2.0 mm PC plastic

RADIATION PATTERN

(Shown as L000941-02 : Others can vary with different cable lengths.)

Test setup

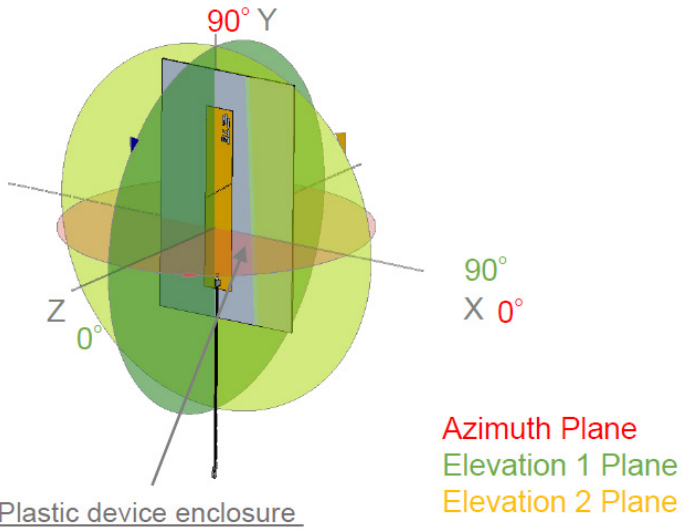

Azimuth(XY)

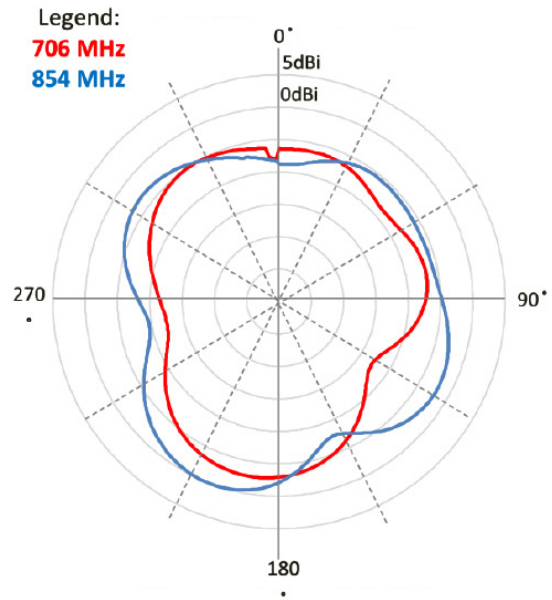

Elevation 1(XZ)

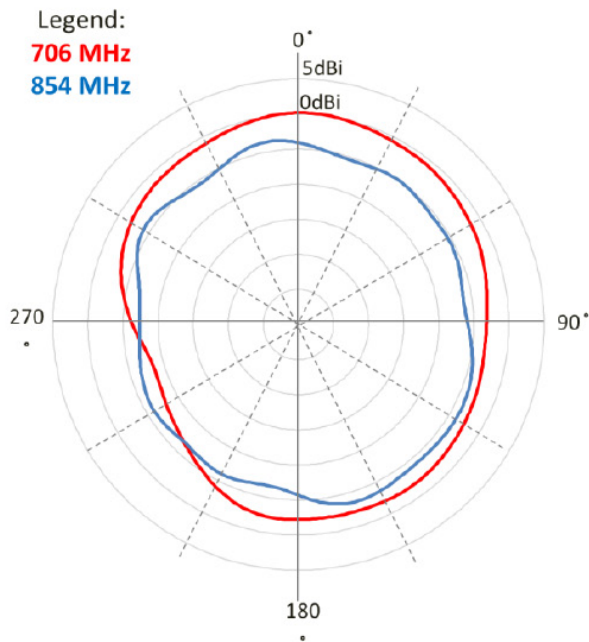

Elevation 2(YZ)

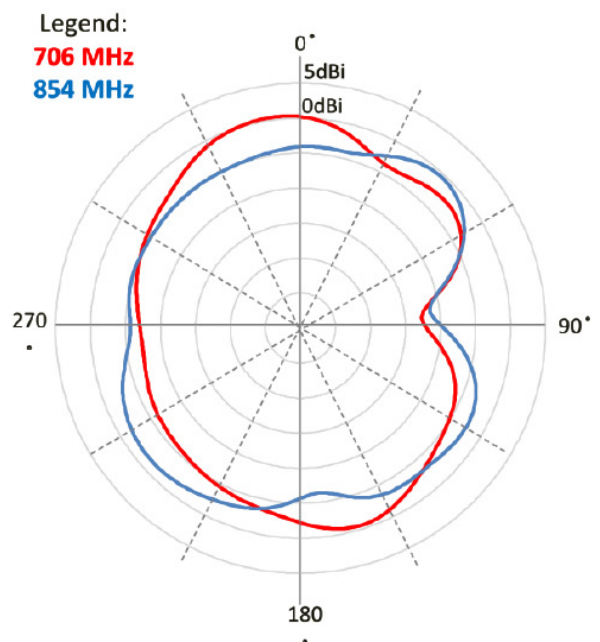

Data measured in free space and on 150 x 150 x 2.0 mm PC plastic

RADIATION PATTERN

(Shown as L000941-02 : Others can vary with different cable lengths.)

Test setup

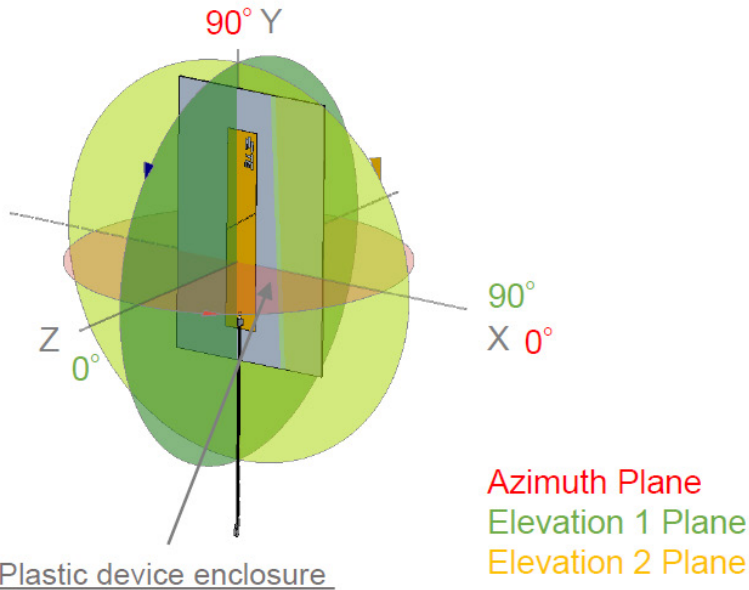

Azimuth(XY)

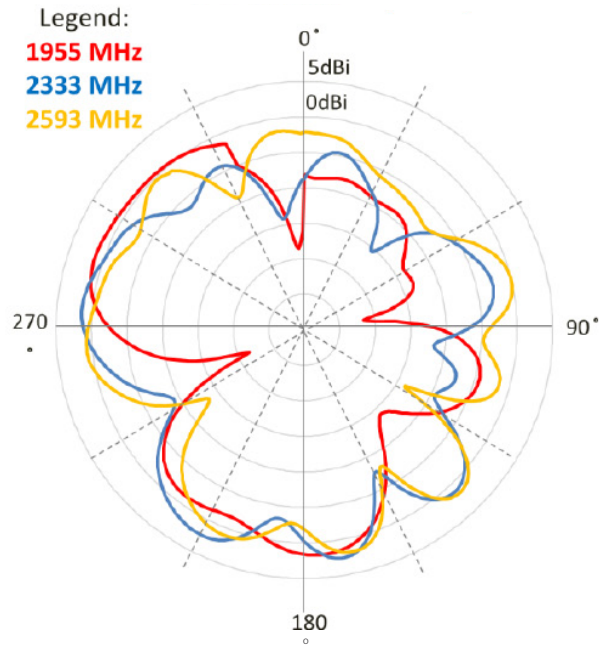

Elevation 1(XZ)

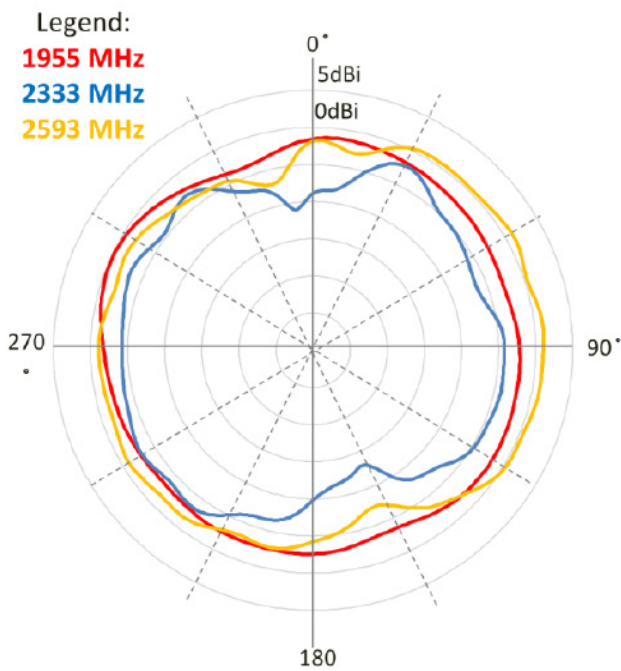

Elevation 2(YZ)

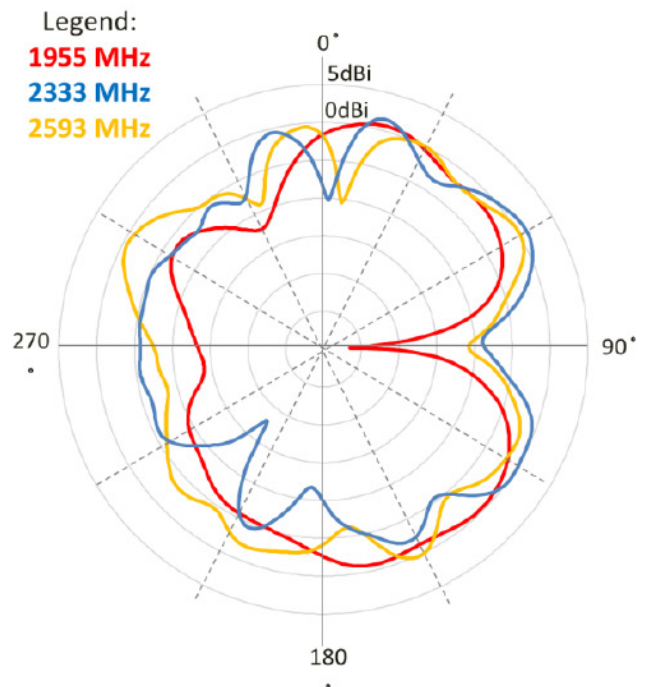

Data measured in free space and on 150 x 150 x 2.0 mm PC plastic

RADIATION PATTERN

(Shown as L000941-02 : Others can vary with different cable lengths.)

Test setup

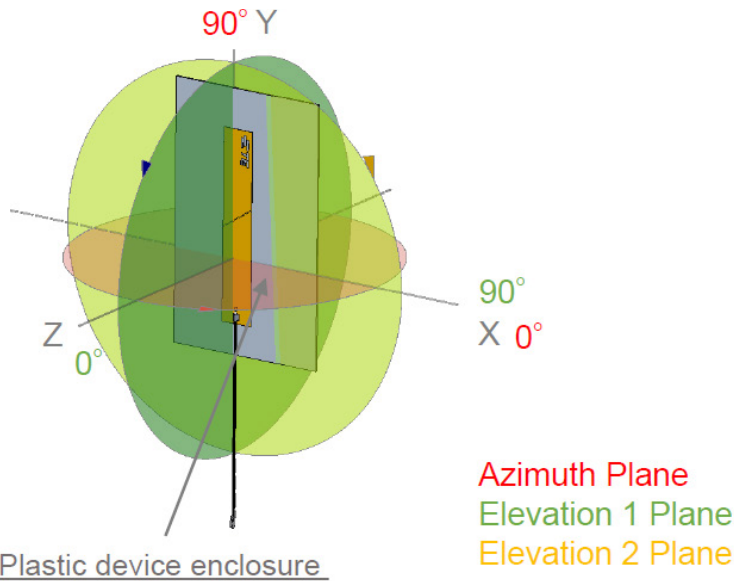

Azimuth(XY)

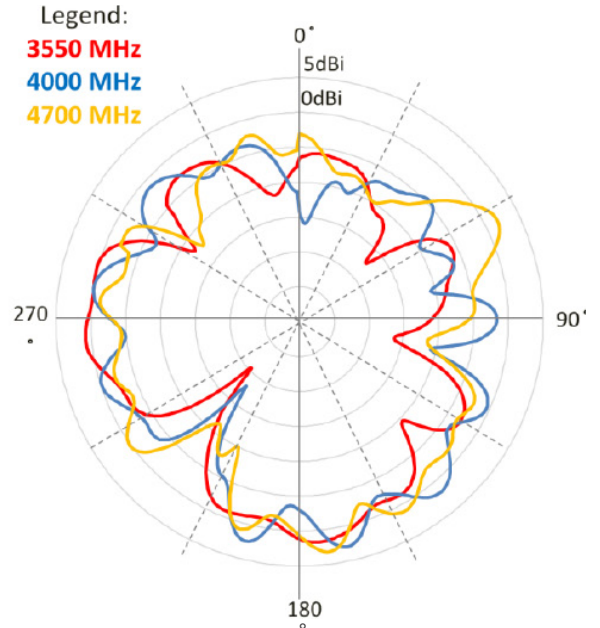

Elevation 1(XZ)

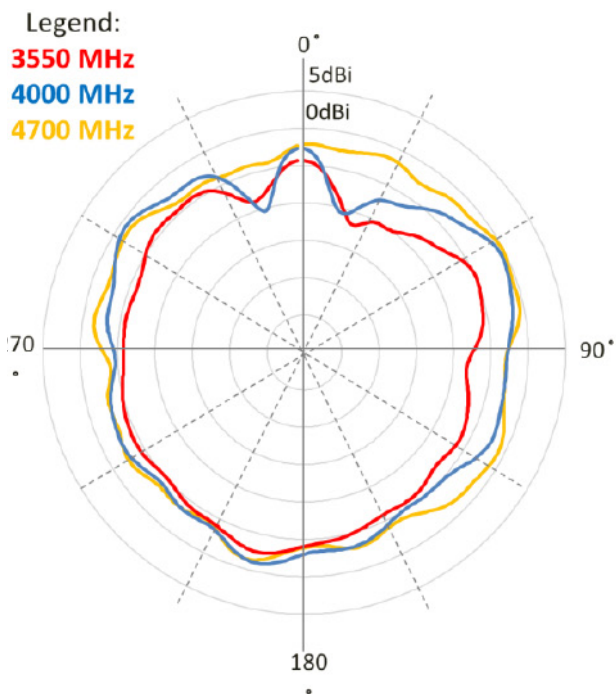

Elevation 2(YZ)

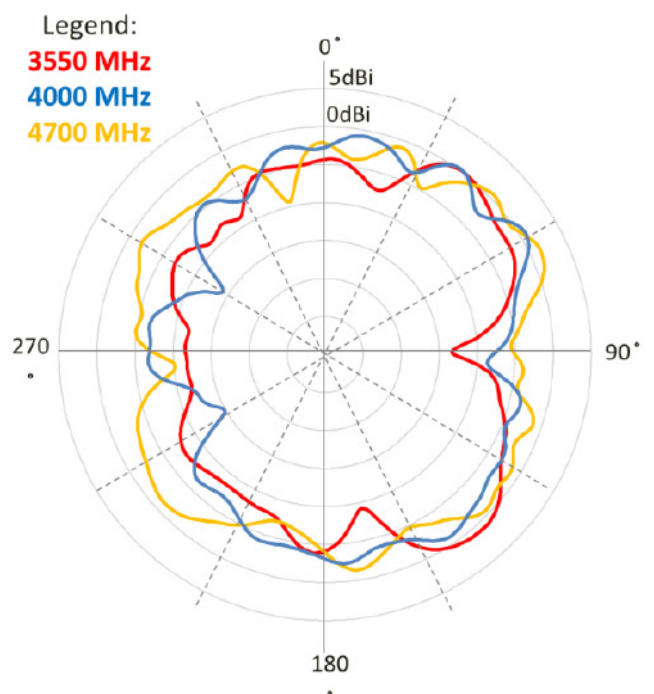

Data measured in free space and on 150 x 150 x 2.0 mm PC plastic

KEEP OUT AREA

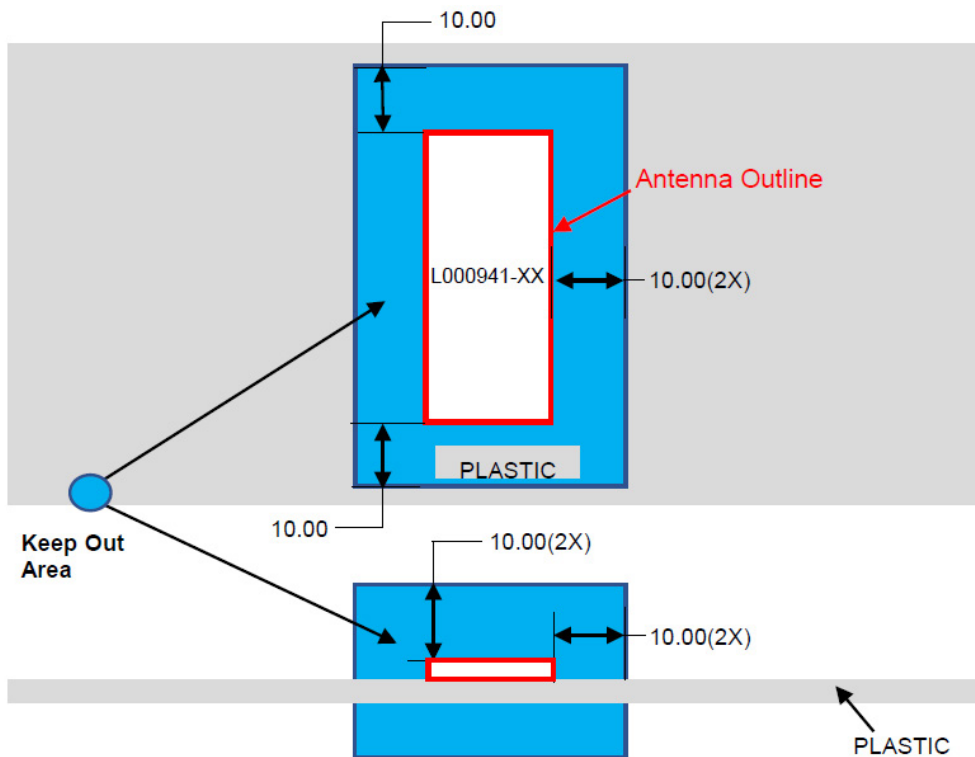

NOTES

1. Antenna designed to be mounted on plastic cover.
2. Area in blue indicates Keep Out Area.
3. Contact TE if keep out zone cannot be guaranteed.

Dimension: mm
Diagram is not to scale

DIMENSIONS

(Refer to Page 12 for dimensions A and B)

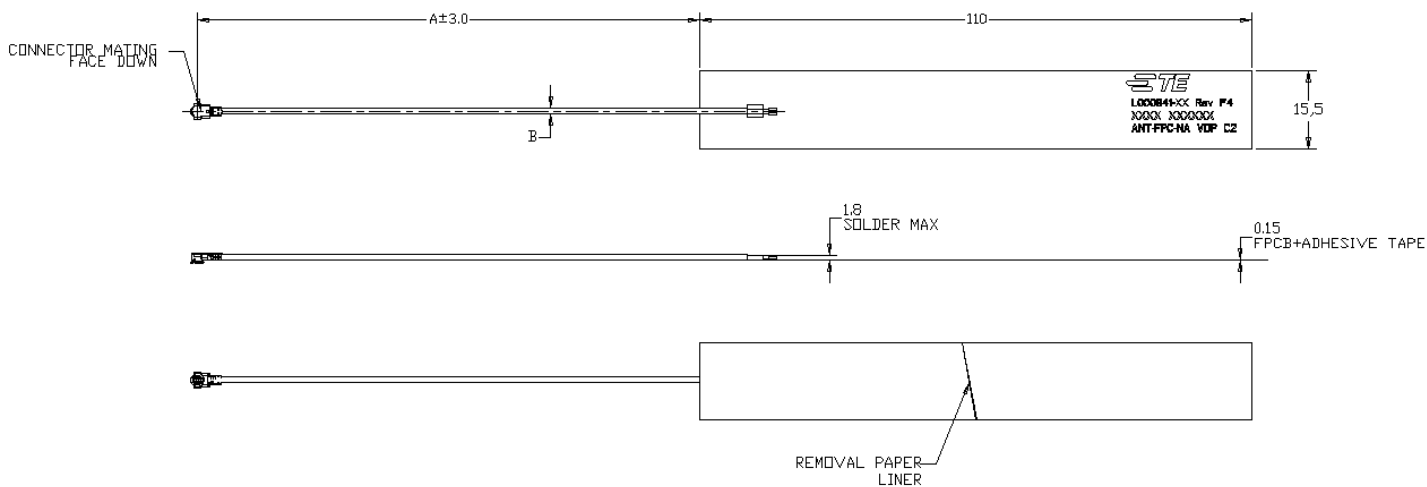

Dimension: mm
Diagram is not to scale

617-5000 MHZ VDP 5G/LTE CELLULAR, NB-IOT, CAT-M WIDEBAND FPC ANTENNAS

Standard Antenna Solutions

PACKAGING

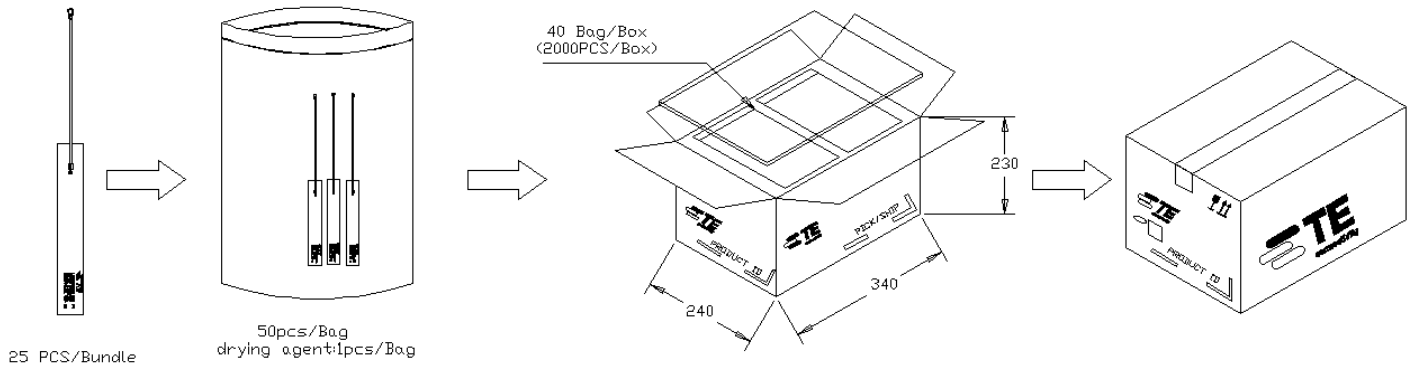

TE TECHNICAL SUPPORT CENTER

USA: +1 (800) 522-6752

Canada: +1 (905) 475-6222

Mexico: +52 (0) 55-1106-0800

Latin/S. America: +54 (0) 11-4733-2200

Germany: +49 (0) 6251-133-1999

UK: +44 (0) 800-267666

France: +33 (0) 1-3420-8686

Netherlands: +31 (0) 73-6246-999

China: +86 (0) 400-820-6015

For phone numbers in other countries, go to te.com/support-center

te.com

TE, TE Connectivity, TE connectivity (logo) are trademarks owned or licensed by the TE Connectivity plc family of companies. Other product names, logos, and company names mentioned herein may be trademarks of their respective owners.

The information given herein, including drawings, illustrations and schematics which are intended for illustration purposes only, is believed to be reliable. However, TE Connectivity makes no warranties as to its accuracy or completeness and disclaims any liability in connection with its use. TE Connectivity's obligations shall only be as set forth in TE Connectivity's Standard Terms and Conditions of Sale for this product and in no case will TE Connectivity be liable for any incidental, indirect or consequential damages arising out of the sale, resale, use or misuse of the product. Users of TE Connectivity products should make their own evaluation to determine the suitability of each such product for the specific application. Antenna performance may vary. TE is a component manufacturer, and customer and/or end-user is responsible for all end-use compliance and regulatory requirements.

©2025 TE Connectivity. All Rights Reserved.

02-25

X-ON Electronics

Largest Supplier of Electrical and Electronic Components

Click to view similar products for [Antennas](#) category:

Click to view products by [TE Connectivity](#) manufacturer:

Other Similar products are found below :

[930-033-R](#) [108-00014-50](#) [66089-2406](#) [A09-F8NF-M](#) [A09-F5NF-M](#) [RGFRA1903041A1T](#) [W1049B090](#) [WTL2449CQ1-FRSMM](#) [CPL9C](#)
[0600-00060](#) [PAL90209H-FNF](#) [GD53-25](#) [S9025PLSMF](#) [GPSCPMM00](#) [ANTDOM-05-01-WPM](#) [ANT-WP868SMA-Y](#) [CBNC58](#) [ABFT](#)
[LP800NMOW](#) [NMOQ88C](#) [NMOQB](#) [NMOQC](#) [ANT-GSMGPSPUKS](#) [60210](#) [60140](#) [ANT-8WPIG-UFL](#) [ANT-GPSPUKS](#) [A21H0](#) [29000863](#)
[29000848](#) [955179003](#) [RFANT2012090A0T](#) [RGFRA3216110A5T](#) [22100003](#) [DL-T022-2.4G](#) [DL-T023-4G](#) [T1-915M](#) [DL-T021-2.4GW](#) [DL-](#)
[T021-2.4G](#) [KH-IPEX-1.13](#) [BWGNXCX16-6B1Y2L120](#) [BWGNXCX15-15B1Y4L120](#) [DL-T023-4GW](#) [DL-J020-433M](#) [J008-GSM](#)
[3N0401LG-021](#) [KHA\(RG1.13\)-TX90B-IPEX](#) [KH-GPS181804-WY](#) [KHA\(RG1.13\)-TX80B-IPEX](#) [TX5800-JZ-5](#)