

REVISIONS					
P	LTR	DESCRIPTION	DATE	DWN	APVD
H		REVISED PER ECO-19-009770	15MAY2019	AL	HL

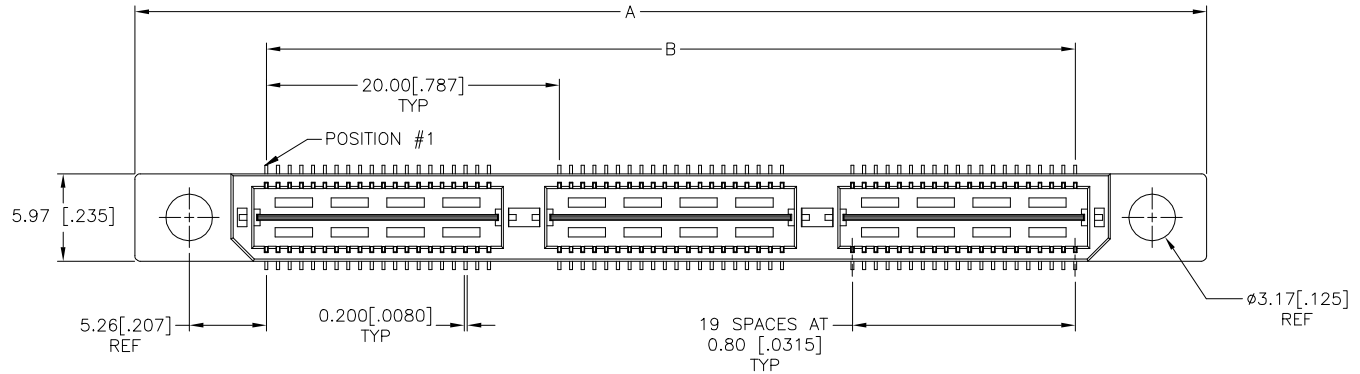

- ① HOUSING: LCP, BLACK.
CONTACT & GROUND PLANE: PHOS BRONZE.
- ② CONTACT PLATING: SELECT 0.25 MICROMETERS
[.00010 IN.] MIN. GOLD.
- ③ FOR STANDARD APPLICATIONS, ORIENTATION HOLE TO BE
ø1.02 [ø.040].

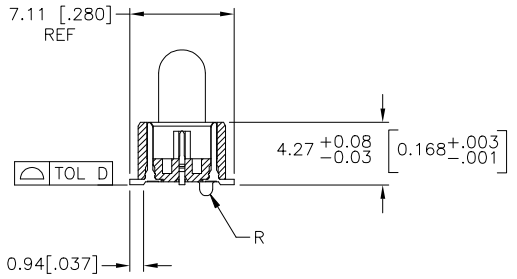
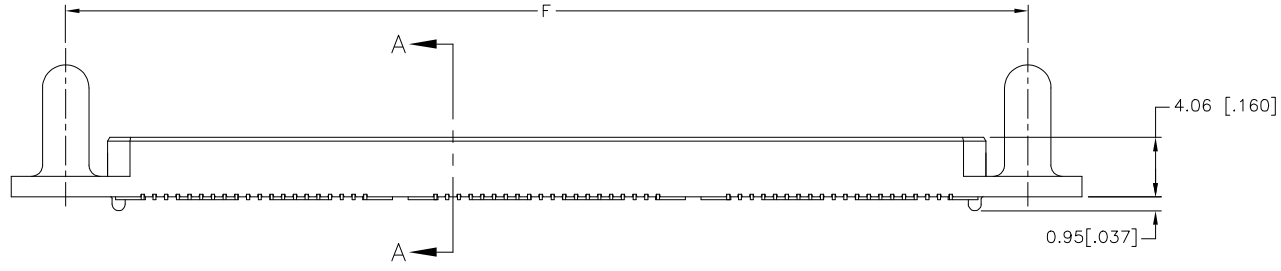

SECTION A-A

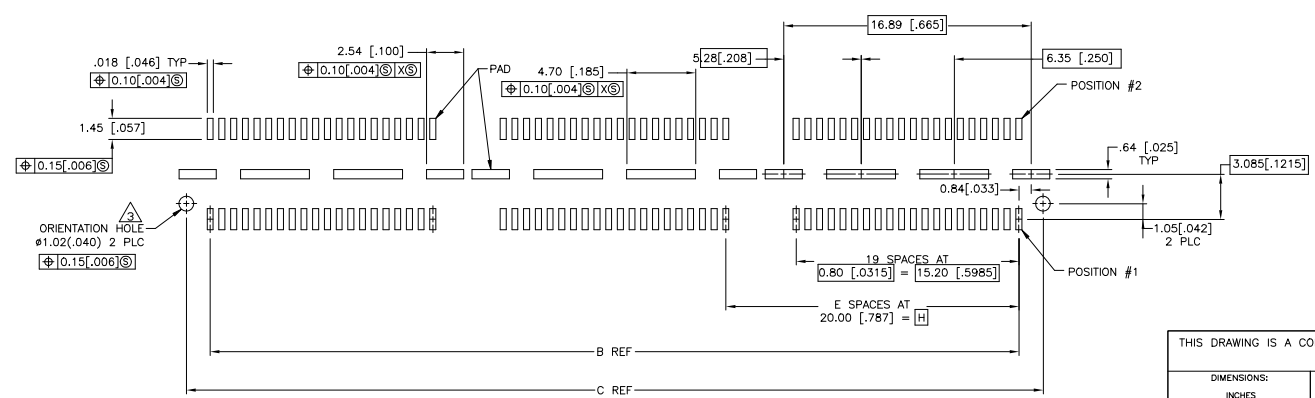
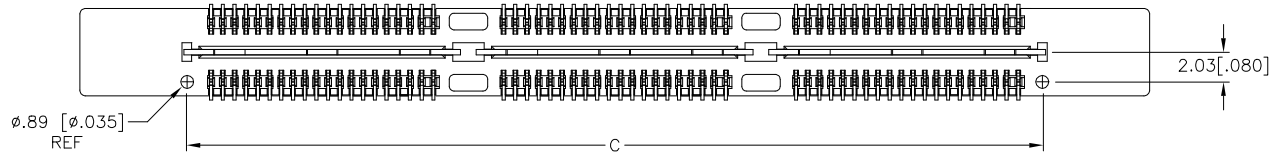

RECOMMENDED PC BOARD LAYOUT
(VIEWED FROM CONNECTOR SIDE)

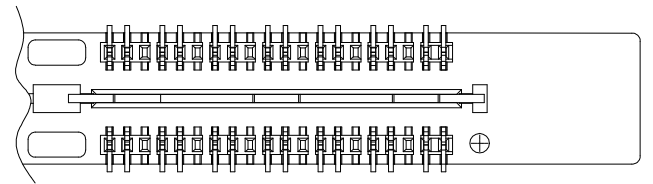

DIFFERENTIAL PAIR LOADING
(BOTTOM VIEW)
SCALE 2:1

THIS DRAWING IS A CONTROLLED DOCUMENT.		DWN: B. CARBO 03MAR03	TE Connectivity Ltd.
DIMENSIONS: INCHES		CHK: D. DIXON 03MAR03	
TOLERANCES UNLESS OTHERWISE SPECIFIED:		APVD: D. DIXON 03MAR03	NAME: PLUG ASSEMBLY, 5.0MM [0.197] VERTICAL, 0.80MM CL, MICTOR SB
0 PLC ± -	1 PLC ± 0.3[.01]	PRODUCT SPEC	SIZE: A2
2 PLC ± 0.13[.005]	3 PLC ± 0.05[1.0020]	APPLICATION SPEC	CAGE CODE: 00779
4 PLC ± -	ANGLES ± 2'	FINISH	DRAWING NO: 1658063
MATERIAL	FINISH	WEIGHT	RESTRICTED TO: -
①	②	CUSTOMER DRAWING	SCALE: 4:1 SHEET: 1 of 2 REV: H

THIS DRAWING IS UNPUBLISHED. RELEASED FOR PUBLICATION
 © COPYRIGHT - TE Connectivity Ltd. ALL RIGHTS RESERVED.

REVISIONS					
P	LTR	DESCRIPTION	DATE	DWN	APVD
-	-	SEE SHEET 1	-	-	-

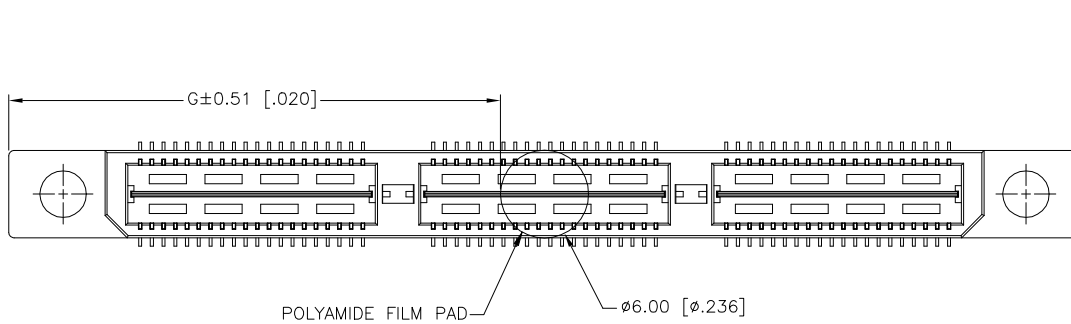

20.00(.7874)	23.06(.908)	45.72(1.800)	1	0.102(.0040)	38.48(1.515)	35.20(1.386)	53.14(2.092)	YES	POCKET TAPE	YES	56	7-1658063-2
0(.000)	13.08(.515)	25.72(1.013)	0	0.102(.0040)	18.49(.728)	15.20(.598)	33.15(1.305)	YES	POCKET TAPE	YES	28	7-1658063-1
20.00(.7874)	23.06(.908)	45.72(1.800)	1	0.102(.0040)	38.48(1.515)	35.20(1.386)	53.14(2.092)	YES	POCKET TAPE	NO	80	6-1658063-2
0(.000)	13.08(.515)	25.72(1.013)	0	0.102(.0040)	18.49(.728)	15.20(.598)	33.15(1.305)	YES	POCKET TAPE	NO	40	6-1658063-1
20.00(.7874)	-	45.72(1.800)	1	0.102(.0040)	38.48(1.515)	35.20(1.386)	53.14(2.092)	NO	POCKET TAPE	YES	56	5-1658063-2
0(.000)	-	25.72(1.013)	0	0.102(.0040)	18.49(.728)	15.20(.598)	33.15(1.305)	NO	POCKET TAPE	YES	28	5-1658063-1
20.00(.7874)	-	45.72(1.800)	1	0.102(.0040)	38.48(1.515)	35.20(1.386)	53.14(2.092)	NO	POCKET TAPE	NO	80	4-1658063-2
0(.000)	-	25.72(1.013)	0	0.102(.0040)	18.49(.728)	15.20(.598)	33.15(1.305)	NO	POCKET TAPE	NO	40	4-1658063-1
80.00(3.150)	53.07(2.090)	105.72(4.162)	4	0.152(.0060)	98.50(3.878)	95.20(3.748)	113.15(4.454)	YES	TRAY	YES	140	3-1658063-5
60.00(2.362)	43.08(1.696)	85.72(3.375)	3	0.152(.0060)	78.49(3.090)	75.20(2.961)	93.14(3.667)	YES	TRAY	YES	112	3-1658063-4
40.00(1.575)	33.07(1.302)	65.72(2.587)	2	0.152(.0060)	58.50(2.303)	55.20(2.173)	73.15(2.88)	YES	TRAY	YES	84	3-1658063-3
20.00(.7874)	23.06(.908)	45.72(1.800)	1	0.102(.0040)	38.48(1.515)	35.20(1.386)	53.14(2.092)	YES	TRAY	YES	56	3-1658063-2
0(.000)	13.08(.515)	25.72(1.013)	0	0.102(.0040)	18.49(.728)	15.20(.598)	33.15(1.305)	YES	TRAY	YES	28	3-1658063-1
80.00(3.150)	53.07(2.090)	105.72(4.162)	4	0.152(.0060)	98.50(3.878)	95.20(3.748)	113.15(4.454)	YES	TRAY	NO	200	2-1658063-5
60.00(2.362)	43.08(1.696)	85.72(3.375)	3	0.152(.0060)	78.49(3.090)	75.20(2.961)	93.14(3.667)	YES	TRAY	NO	160	2-1658063-4
40.00(1.575)	33.07(1.302)	65.72(2.587)	2	0.152(.0060)	58.50(2.303)	55.20(2.173)	73.15(2.88)	YES	TRAY	NO	120	2-1658063-3
20.00(.7874)	23.06(.908)	45.72(1.800)	1	0.102(.0040)	38.48(1.515)	35.20(1.386)	53.14(2.092)	YES	TRAY	NO	80	2-1658063-2
0(.000)	13.08(.515)	25.72(1.013)	0	0.102(.0040)	18.49(.728)	15.20(.598)	33.15(1.305)	YES	TRAY	NO	40	2-1658063-1
80.00(3.150)	-	105.72(4.162)	4	0.152(.0060)	98.50(3.878)	95.20(3.748)	113.15(4.454)	NO	TRAY	YES	140	1-1658063-5
60.00(2.362)	-	85.72(3.375)	3	0.152(.0060)	78.49(3.090)	75.20(2.961)	93.14(3.667)	NO	TRAY	YES	112	1-1658063-4
40.00(1.575)	-	65.72(2.587)	2	0.152(.0060)	58.50(2.303)	55.20(2.173)	73.15(2.88)	NO	TRAY	YES	84	1-1658063-3
20.00(.7874)	-	45.72(1.800)	1	0.102(.0040)	38.48(1.515)	35.20(1.386)	53.14(2.092)	NO	TRAY	YES	56	1-1658063-2
0(.000)	-	25.72(1.013)	0	0.102(.0040)	18.49(.728)	15.20(.598)	33.15(1.305)	NO	TRAY	YES	28	1-1658063-1
80.00(3.150)	-	105.72(4.162)	4	0.152(.0060)	98.50(3.878)	95.20(3.748)	113.15(4.454)	NO	TRAY	NO	200	1658063-5
60.00(2.362)	-	85.72(3.375)	3	0.152(.0060)	78.49(3.090)	75.20(2.961)	93.14(3.667)	NO	TRAY	NO	160	1658063-4
40.00(1.575)	-	65.72(2.587)	2	0.152(.0060)	58.50(2.303)	55.20(2.173)	73.15(2.88)	NO	TRAY	NO	120	1658063-3
20.00(.7874)	-	45.72(1.800)	1	0.102(.0040)	38.48(1.515)	35.20(1.386)	53.14(2.092)	NO	TRAY	NO	80	1658063-2
0(.000)	-	25.72(1.013)	0	0.102(.0040)	18.49(.728)	15.20(.598)	33.15(1.305)	NO	TRAY	NO	40	1658063-1
H	G	F	E	D	C	B	A	POLYIMIDE FILM PAD ▲	PACKAGING TYPE	DIFF. PAIR	NO OF POS	PART NUMBER

THIS DRAWING IS A CONTROLLED DOCUMENT. DWN B. CARBO 03MAR03
 CHK D. DIXON 03MAR03
 APVD D. DIXON 03MAR03

TE Connectivity Ltd.

PLUG ASSEMBLY, 5.0MM [.197] VERTICAL,
 0.80MM CL,
 MICTOR SB

SIZE A2 CAGE CODE 00779 DRAWING NO. C=1658063 RESTRICTED TO

WEIGHT - SCALE 4:1 SHEET 2 of 2 REV H

CUSTOMER DRAWING

X-ON Electronics

Largest Supplier of Electrical and Electronic Components

Click to view similar products for [Board to Board & Mezzanine Connectors](#) category:

Click to view products by [TE Connectivity](#) manufacturer:

Other Similar products are found below :

[589158040000018](#) [MDF7C-18P-2.54DSA\(55\)](#) [FCN-230C068-11](#) [FCN-268F012-G/BD](#) [FCN-268F036-G/BD](#) [FCN-268M012-G/0D](#) [FCN-268M024-G/1D](#) [FCN-723J004/1](#) [MIS-048-01-F-D-DP-K](#) [832-10-034-10-001000](#) [FX4C-80S-1.27DSA](#) [FCN-214Q030-G/0](#) [FCN-234P048-G/0](#) [FCN-235D050-G/C](#) [210-93-314-41-105000](#) [2-22603-0](#) [MDF7-40DP-2.54DSA\(55\)](#) [AXG720047](#) [5031084030](#) [MIT-114-03-F-D-K](#) [55323-1519](#) [DF33-2P-3.3DSA\(24\)](#) [YFT-20-05-H-03-SB-K](#) [503308-3040](#) [026-6203-PDB](#) [027-6203-PDB](#) [069159702701000](#) [10123981-102LF](#) [101A10019X](#) [55650-0588-C](#) [68684-306](#) [75140-7012](#) [194261-1](#) [FCN-268F024-G0D](#) [10124054-515LF](#) [68685-603](#) [8-1616154-3](#) [MIS-019-01-F-D](#) [541371078](#) [IL-WX-10PB-HF-B-E1000E](#) [FCN-268M024-G/3D](#) [20021832-06016C1LF](#) [KX15-20KLDL-E1000E](#) [MDF7-16DP-2.54DSA\(55\)](#) [AXE810124](#) [FCN-214J100-G/0](#) [FCN-230C068-E/S](#) [AXE812124](#) [AXE816124](#) [AXE720127](#)