



Global 5G / LTE Low-Profile Wideband Antenna

Part Number: 2487514-1

FEATURES & BENEFITS

- Omnidirectional coverage
- Low-profile / height (50mm) for improved clearance
- Wideband coverage for sub-6 GHz 5G frequencies plus legacy 3G, 4G
- RoHS 2.0 Compliant, REACH Compliant

SPECIFICATIONS

Frequency Range (MHz)	617-698	698-960	1427-1661	1695-2400	2484-2690	3300-4200	4400-5000
VSWR	< 9.4:1	< 5.8:1	< 3.1:1	< 2.7:1	< 1.8:1	< 3.5:1	< 4.3:1
Average Efficiency	39.47%	47.35%	68.30%	69.87%	71.15%	57.96%	55.52%
Peak Gain	-1.6dBi	0.2dBi	3.8dBi	4.2dBi	4.9dBi	4.8dBi	1.4dBi
Average Gain	-4.0dBi	-3.4dBi	-1.7dBi	-1.6dBi	-1.5dBi	-2.4dBi	-2.6dBi
Power Handling	5 Watt CW						
Feed Point Impedance	50 ohms						
Polarization	Linear						
Size	Length 50.0 mm($\pm 2mm$) x Diameter 8.0 mm ($\pm 0.2mm$) With SMA connector						
Weight	< 7 g						
Mounting	SMA plug						
Operating Temperature	-30 to +75°C						
Storage Temperature	-30 to +75°C						
Packaging Specification	Bag & Box						
Hazardous Materials	A certificate of conformance is available from the product page on TE website.						
Data measured in free space and on reference ground plane of 155 mm ground length and 55.0 mm width, application data might vary.							

PERFORMANCE

VSWR

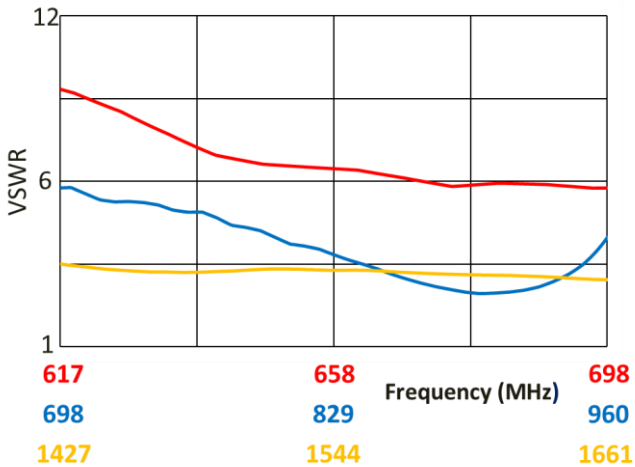

Return Loss

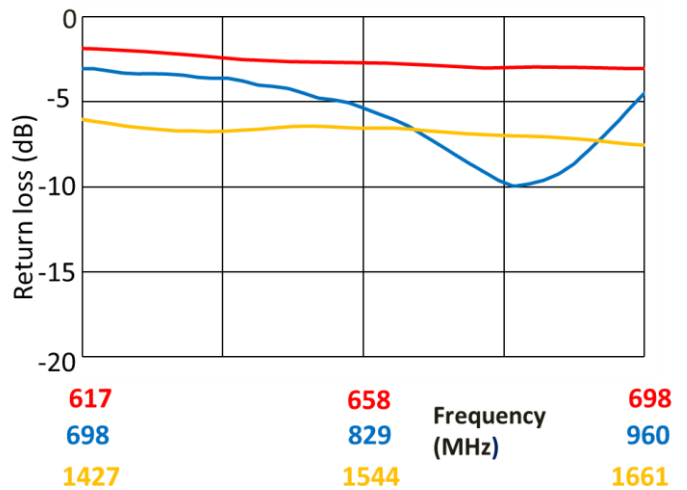

Peak Gain

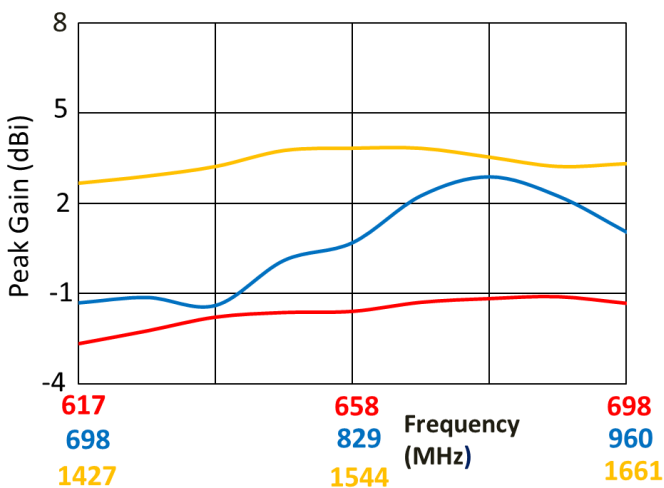

Efficiency

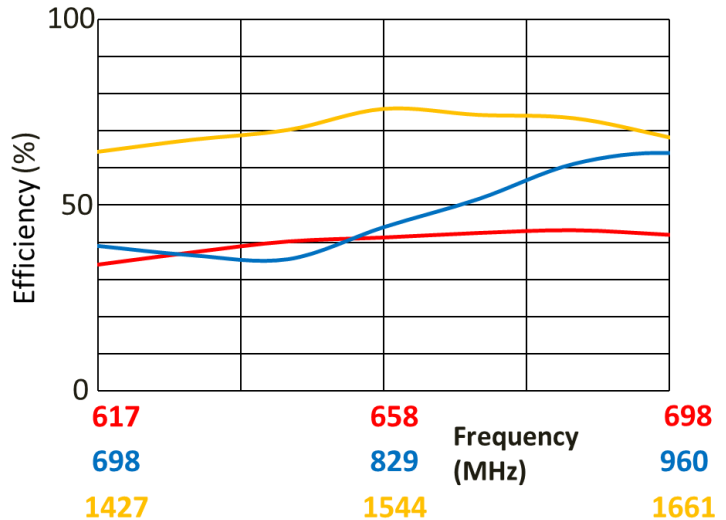

Data measured in free space and on reference ground plane of 155mm ground length and 55mm width, application data might vary.

PERFORMANCE

VSWR

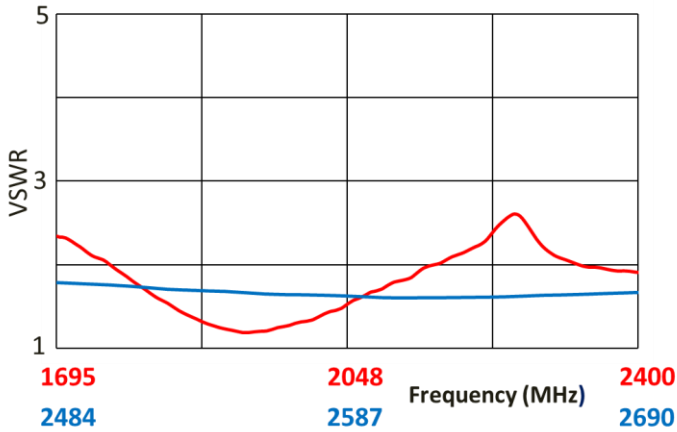

Return Loss

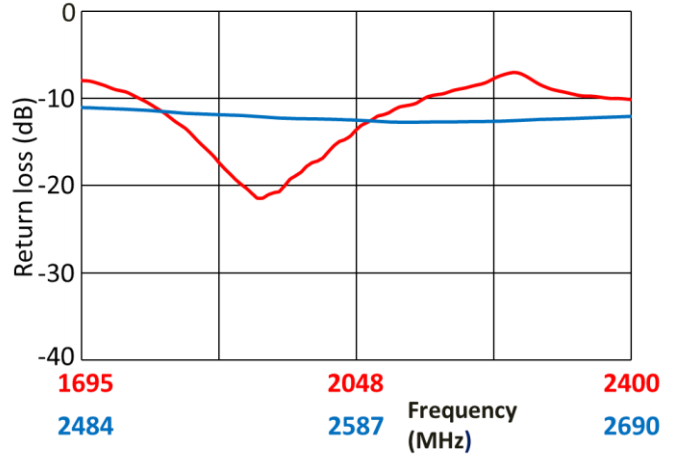

Peak Gain

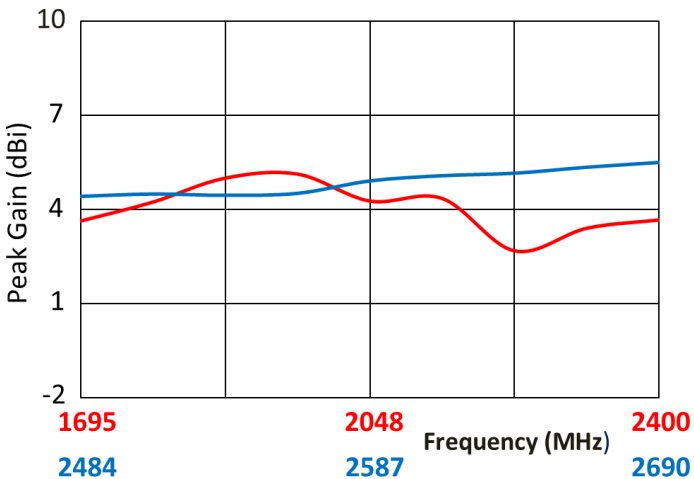

Efficiency

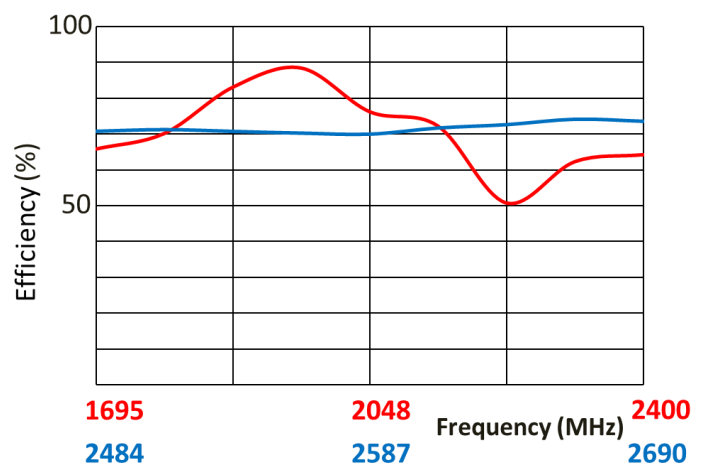

Data measured in free space and on reference ground plane of 155mm ground length and 55mm width, application data might vary.

PERFORMANCE

VSWR

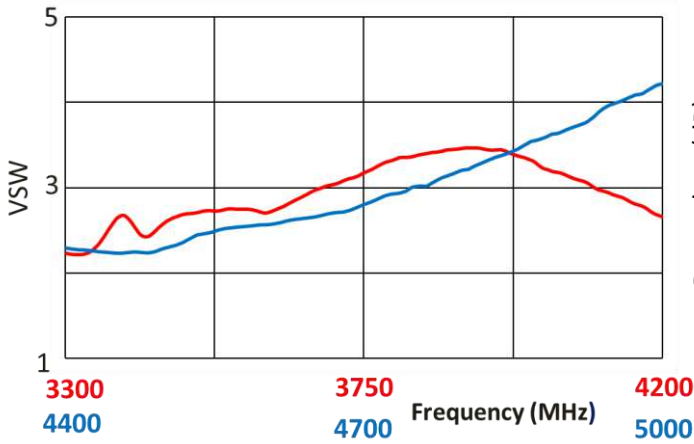

Return Loss

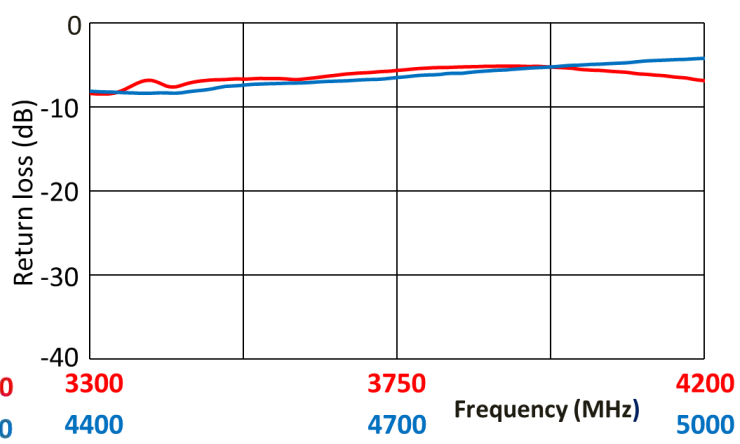

Peak Gain

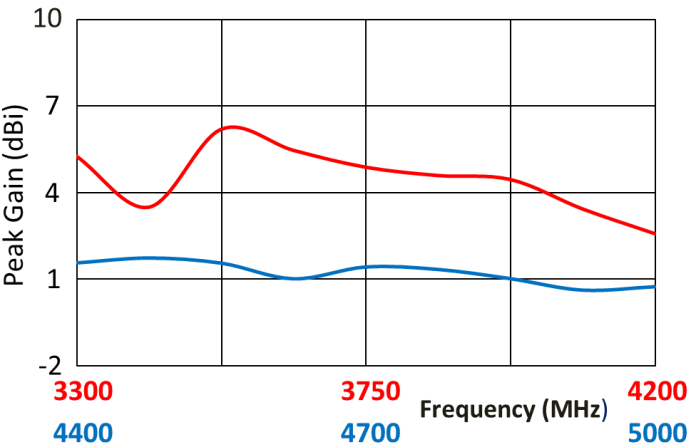

Efficiency

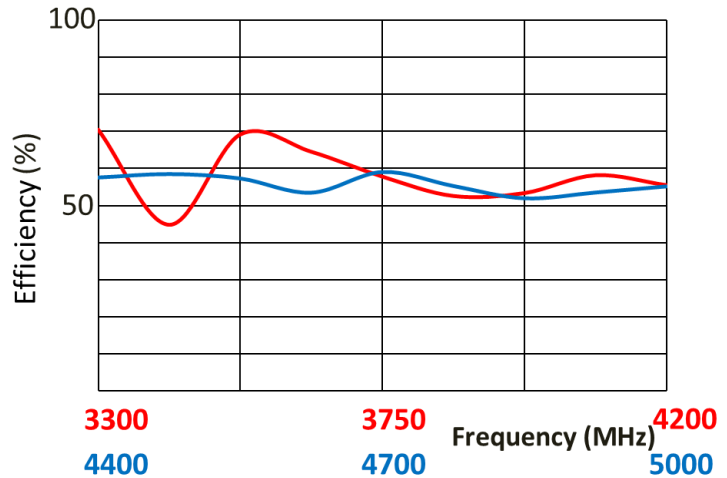

Data measured in free space and on reference ground plane of 155mm ground length and 55mm width, application data might vary.

RADIATION PATTERN

Test setup

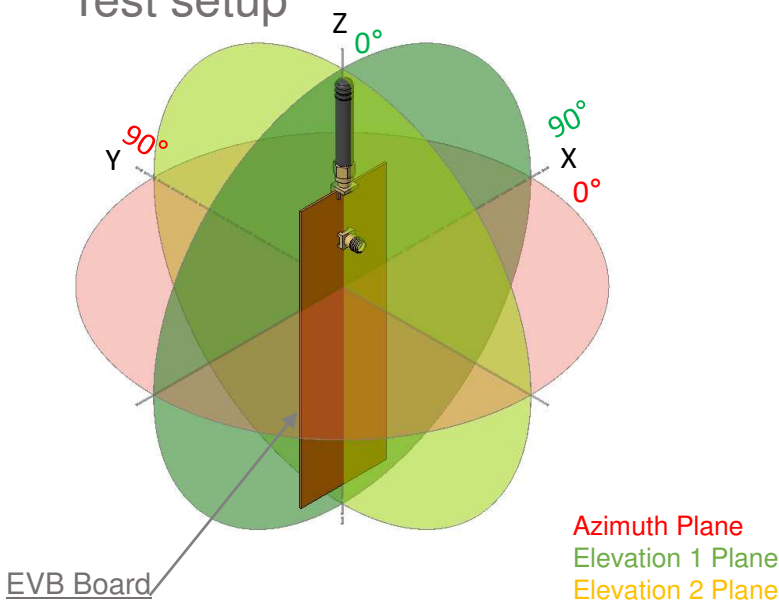

Azimuth(XY)

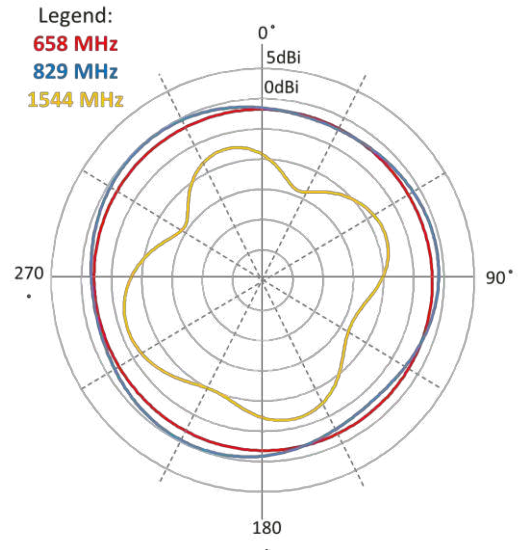

Elevation 1(XZ)

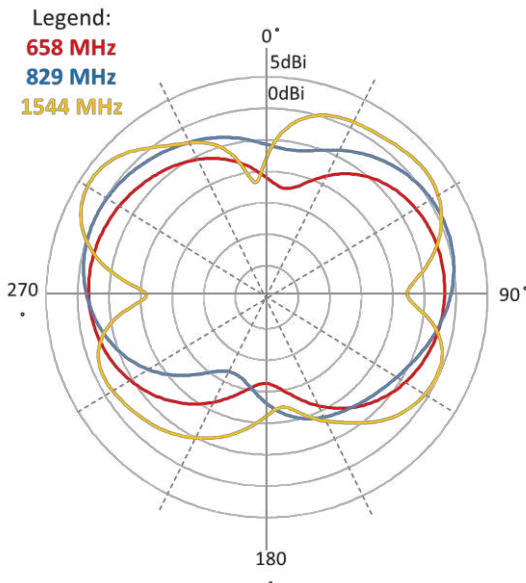

Elevation 2(YZ)

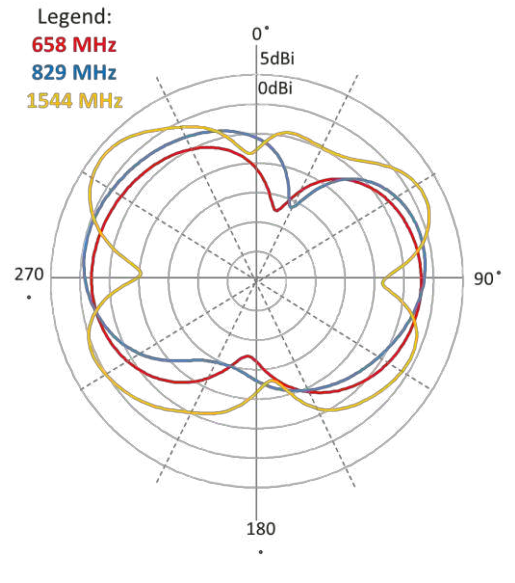

Data measured in free space and on reference ground plane of 155mm ground length and 55mm width, application data might vary

RADIATION PATTERN

Test setup

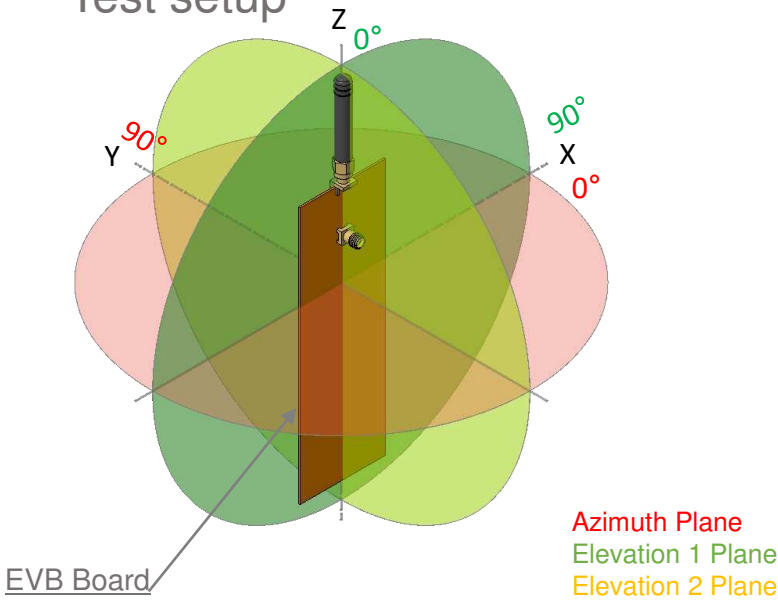

Azimuth(XY)

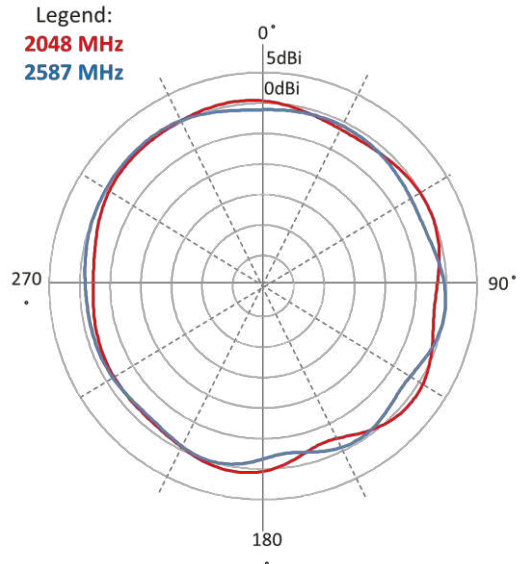

Elevation 1(XZ)

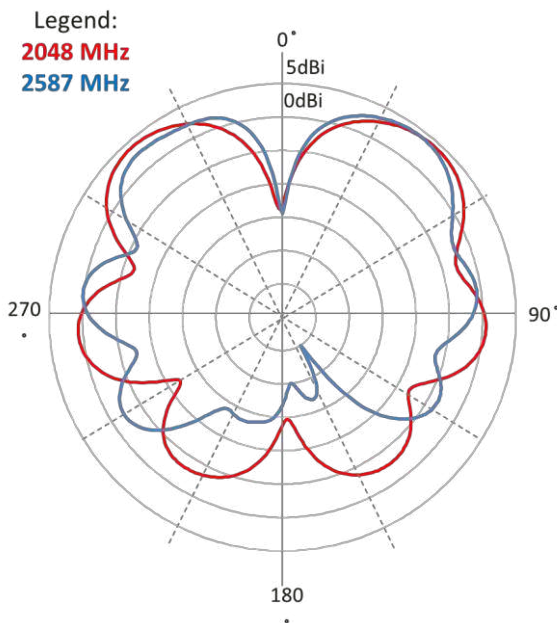

Elevation 2(YZ)

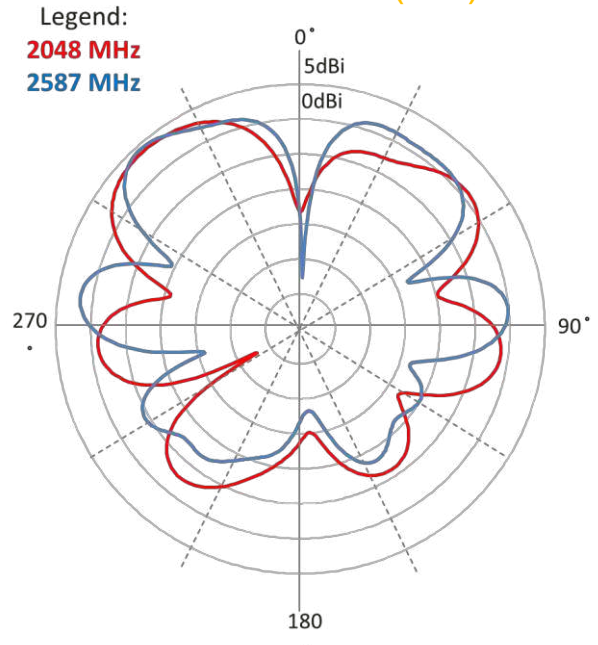

Data measured in free space and on reference ground plane of 155mm ground length and 55mm width, application data might vary

RADIATION PATTERN

Test setup

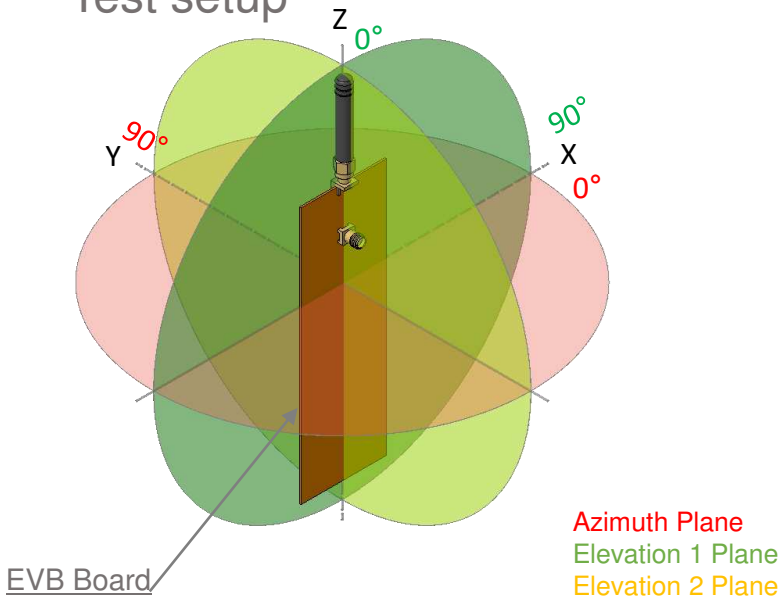

Azimuth(XY)

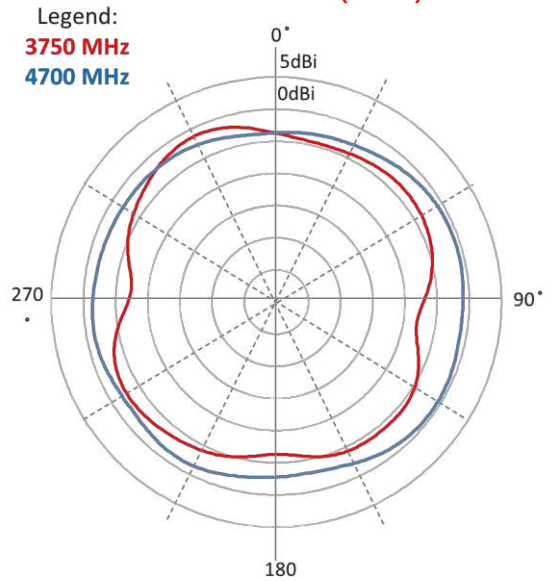

Elevation 1(XZ)

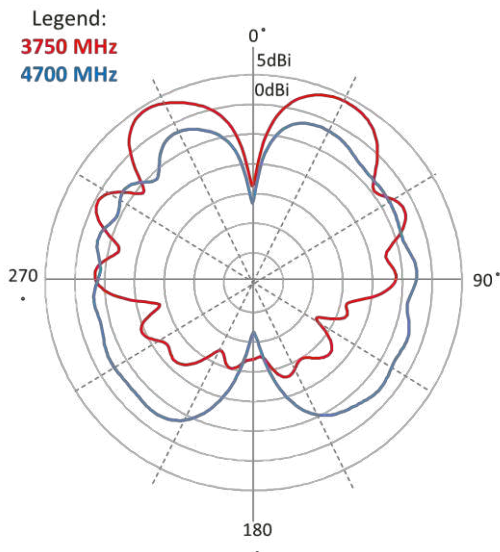

Elevation 2(YZ)

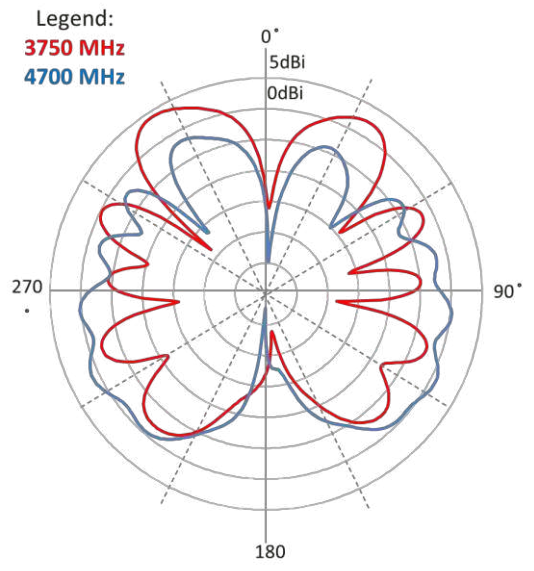

Data measured in free space and on reference ground plane of 155mm ground length and 55mm width, application data might vary

KEEP OUT AREA

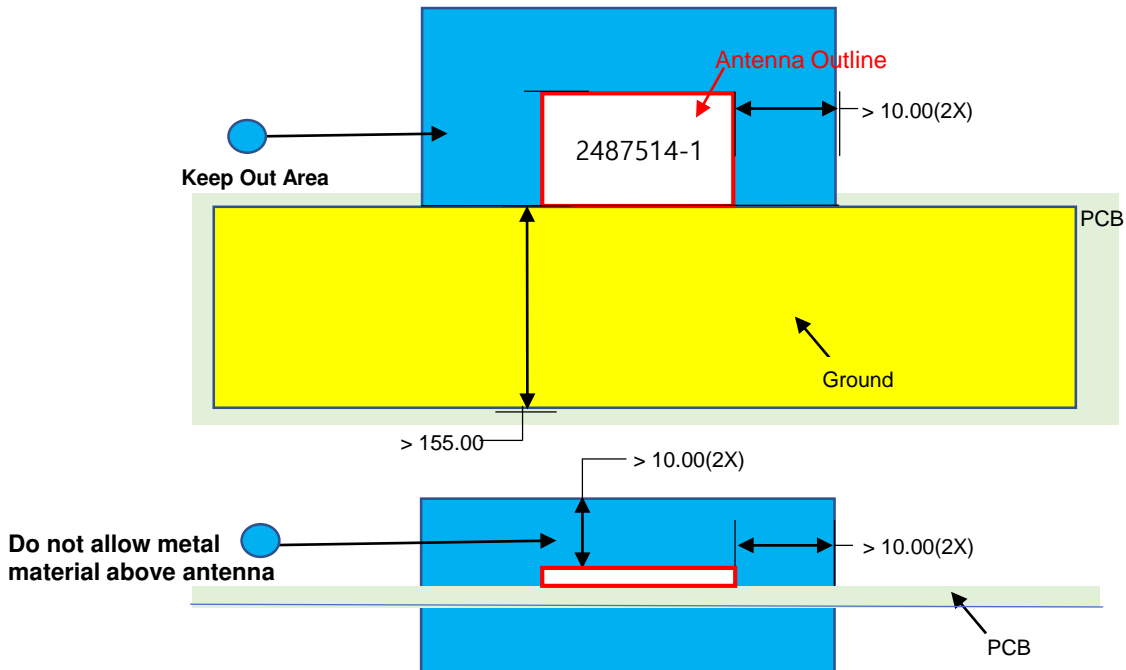

- NOTES:
1. Antenna designed to be screw mounted on PCB.
 2. Bandwidth performance dependent on ground plane size/design suggested minimum ground plane length from ground feed is 155mm
 3. Area in blue above indicates Keep Out area.
 4. For more information, please call TE.

Dimensions: mm
Diagram is not to scale

DIMENSIONS

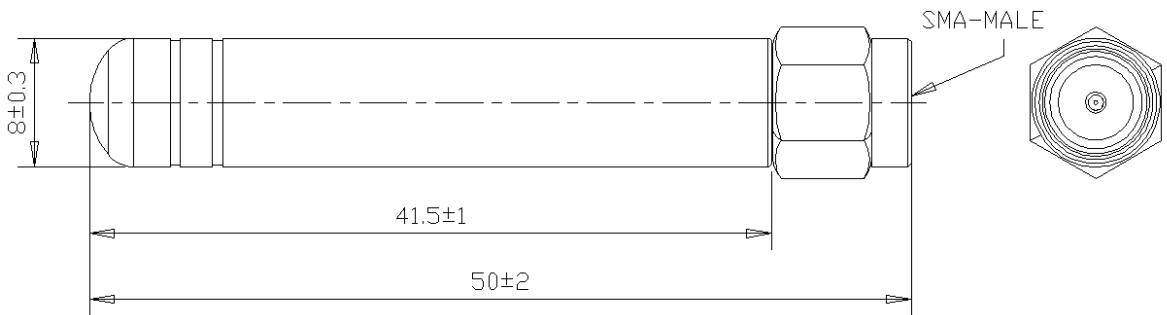

Dimensions: mm
Diagram is not to scale

PACKAGING

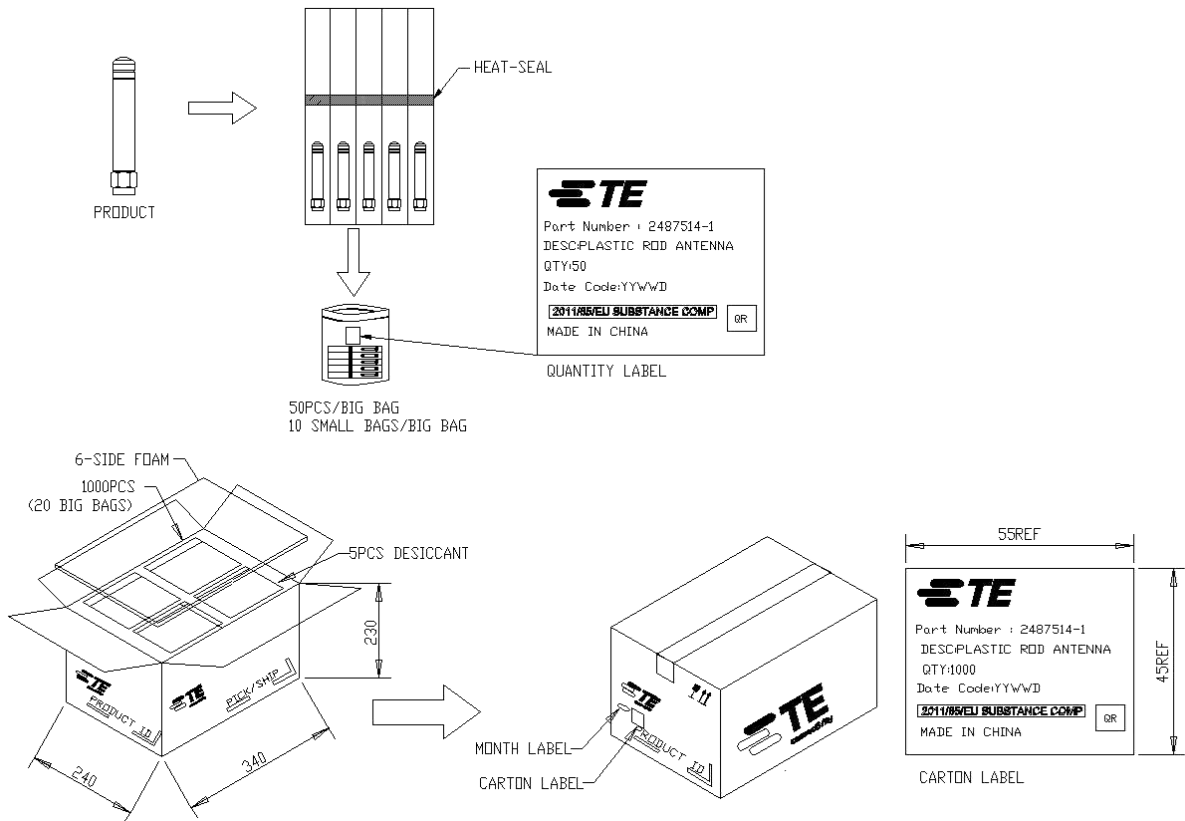

TE TECHNICAL SUPPORT CENTER

- USA: +1 (800) 522-6752
- Canada: +1 (905) 475-6222
- Mexico: +52 (0) 55-1106-0800
- Latin/S. America: +54 (0) 11-4733-2200
- Germany: +49 (0) 6251-133-1999
- UK: +44 (0) 800-267666
- France: +33 (0) 1-3420-8686
- Netherlands: +31 (0) 73-6246-999
- China: +86 (0) 400-820-6015

te.com

TE Connectivity, TE, TE connectivity (logo) are trademarks owned or licensed by the TE Connectivity Ltd. family of companies. All other logos, products and/or company names referred to herein might be trademarks of their respective owners.

The information given herein, including drawings, illustrations and schematics which are intended for illustration purposes only, is believed to be reliable. However, TE Connectivity makes no warranties as to its accuracy or completeness and disclaims any liability in connection with its use. TE Connectivity's obligations shall only be as set forth in TE Connectivity's Standard Terms and Conditions of Sale for this product and in no case will TE Connectivity be liable for any incidental, indirect or consequential damages arising out of the sale, resale, use or misuse of the product. Users of TE Connectivity products should make their own evaluation to determine the suitability of each such product for the specific application.

TE Connectivity warrants to the original end user customer of its products that its products are free from defects in material and workmanship. Subject to conditions and limitations TE Connectivity will, at its option, either repair or replace any part of its products that prove defective because of improper workmanship or materials. This limited warranty is in force for the useful lifetime of the original end product into which the TE Connectivity product is installed. Useful lifetime of the original end product may vary but is not warranted to exceed one (1) year from the original date of the end product purchase.

©2024 TE Connectivity. All Rights Reserved.

07/24 Original

X-ON Electronics

Largest Supplier of Electrical and Electronic Components

Click to view similar products for [Antennas](#) category:

Click to view products by [TE Connectivity](#) manufacturer:

Other Similar products are found below :

[930-033-R](#) [108-00014-50](#) [66089-2406](#) [A09-F8NF-M](#) [A09-F5NF-M](#) [RGFRA1903041A1T](#) [W1049B090](#) [WTL2449CQ1-FRSMM](#) [CPL9C](#)
[0600-00060](#) [PAL90209H-FNF](#) [GD53-25](#) [S9025PLSMF](#) [GPSCPMM00](#) [ANTDOM-05-01-WPM](#) [ANT-WP868SMA-Y](#) [CBNC58](#) [ABFT](#)
[LP800NMOW](#) [NMOQ88C](#) [NMOQB](#) [NMOQC](#) [ANT-GSMGPSPUKS](#) [60210](#) [60140](#) [ANT-8WPIG-UFL](#) [ANT-GPSPUKS](#) [A21H0](#) [29000863](#)
[29000848](#) [955179003](#) [RFANT2012090A0T](#) [RGFRA3216110A5T](#) [22100003](#) [DL-T022-2.4G](#) [DL-T023-4G](#) [T1-915M](#) [DL-T021-2.4GW](#) [DL-](#)
[T021-2.4G](#) [KH-IPEX-1.13](#) [BWGNXCX16-6B1Y2L120](#) [BWGNXCX15-15B1Y4L120](#) [DL-T023-4GW](#) [DL-J020-433M](#) [J008-GSM](#)
[3N0401LG-021](#) [KHA\(RG1.13\)-TX90B-IPEX](#) [KH-GPS181804-WY](#) [KHA\(RG1.13\)-TX80B-IPEX](#) [TX5800-JZ-5](#)