



TAOGLAS®



Datasheet

Raptor Max

Part No:
MAX1016.W.001

Description

16-in-1 Permanent Mount Antenna White with Multiband GNSS, 8 5G/4G, 6 Wi-Fi & 1 LMR Whip with Staggered RG-174/TGC-1.5DS Cables

Features:

Low-profile, IP67 rated Enclosure

8* 5G/4G MIMO 617~6000MHz

6* WIFI MIMO 2.4/5.8/7.125GHz

1* GNSS L1/L5 Dual-band Antenna

1* LMR/TETRA Depending on Whip Used:

- FW.79.M6.F - 700-900MHz Flexible Whip Antenna with M6 female connector
- FW.38.M6.F - 380-400MHz Flexible Whip Antenna with M6 female connector

Dimensions: 330mm x 75.5mm x 45.2mm

RoHS & Reach Compliant

1.	Introduction	3
2.	Specification	4
3.	Mechanical Drawing	8
4.	Packaging	9
5.	Installation Recommendation	10
6.	Antenna Characteristics	11
7.	Active Antenna Characteristics	22
8.	Radiation Patterns	27
<hr/>		
	Changelog	152

Taoglas makes no warranties based on the accuracy or completeness of the contents of this document and reserves the right to make changes to specifications and product descriptions at any time without notice. Taoglas reserves all rights to this document and the information contained herein. Reproduction, use or disclosure to third parties without express permission is strictly prohibited.

Ireland & USA
ISO 9001:2015
Certified



Taiwan
ISO 9001:2015
Certified



1. Introduction



The Taoglas® Raptor MAX series of concept combination antenna are designed to enhance the connectivity options available to you for your vehicle. With up to 16-in-1 connections available, in combinations of Multiband GNSS, 5G/4G MIMO, Wi-Fi MIMO, LMR/VHF/UHF/Tetra, this next generation, super low-profile vehicle roof mount antenna eliminates the need for multiple antenna installations.

The MAX1016 can be configured in any combination of multiband GNSS (L1/L5), up to 8 5G/4G antennas, up to 6 Wi-Fi antennas and LMR/Tetra. Each of the Cellular antennas covers all global 5G/4G bands from 600 to 6000MHz with great efficiency across all bands. The Wi-Fi antennas are designed for Wi-Fi 6e/7 coverage on bands 2.4, 5.8 and 7.125GHz. The embedded multiband active GNSS antenna covers both the L1 and L5 bands, helping you achieve a much greater positional accuracy than from single GNSS. The interchangeable whip FW.79.M6.F and FW.38.M6.F allow you the add frequency bands specific to your requirements either in the LMR or TETRA ranges.

The antenna comes with low-loss TGC-1.5DS coaxial pigtail cables as standard, terminating in SMA(M) / RP-SMA(M), with custom configurations depending on your requirements. The super low profile, fully IP67 rated waterproof enclosure is manufactured from a robust, UV protected ABS material, ideal for use in any environment or weather condition.

Several configurations in both black and white will be available as standard, see below, but other configurations are available upon request, contact your local Taoglas customer service team for more information.

Raptor Max SKU's and Configurations:

MAX1008	8x 5G/4G
MAX1009	1x GNSS & 8x 5G/4G
MAX1012	1x GNSS, 8x 5G/4G & 3x Wi-Fi
MAX1012	1x GNSS, 8x 5G/4G & 4x Wi-Fi
MAX1014	1x GNSS, 8x 5G/4G & 5x Wi-Fi
MAX1015	1x GNSS, 8x 5G/4G & 6x Wi-Fi
MAX1016	1x GNSS, 8x 5G/4G, 6x Wi-Fi & 1x LMR Whip

2. Specification

GNSS Frequency Bands					
GPS	L1 1575.42 MHz	L2 1227.6 MHz	L5 1176.45 MHz		
	■	□	■		
GLONASS	G1 1602 MHz	G2 1248 MHz	G3 1207 MHz		
	□	□	□		
Galileo	E1 1575.24 MHz	E5a 1176.45 MHz	E5b 1201.5 MHz	E6 1278.75 MHz	
	■	■	□	□	
BeiDou	B1C 1575.42 MHz	B1I 1561 MHz	B2a 1176.45 MHz	B2b 1207.14 MHz	B3 1268.52 MHz
	■	■	■	□	□
L-Band	L-Band 1542 MHz				
	□				
QZSS (Regional)	L1 1575.42 MHz	L2C 1227.6 MHz	L5 1176.45 MHz	L6 1278.75e6	
	■	□	■	□	
IRNSS (Regional)	L5 1176.45 MHz				
	■				
SBAS	L1/E1/B1 1575.42 MHz	L5/B2a/E5a 1176.45 MHz	G1 1602 MHz	G2 1248 MHz	G3 1207 MHz
	■	■	□	□	□

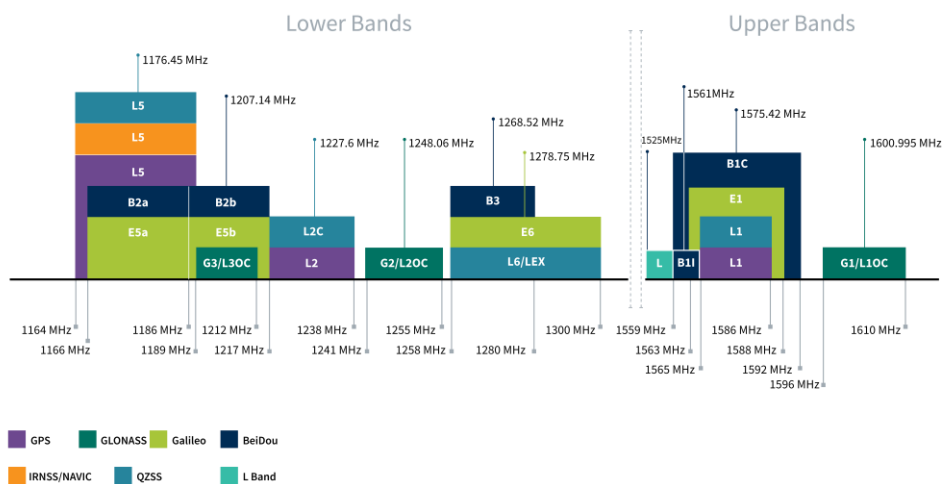

GNSS Bands and Constellations

GNSS Electrical			
Frequency (MHz)	1176.45	1561	1575.42
VSWR (max.)	3:1	3:1	3:1
Passive Antenna Efficiency (%)	37.77	33.44	40.65
Passive Antenna Gain at Zenith (dBi)	1.75	3.59	4.51
Polarization	Linear		
Impedance	50 Ω		

LNA and Electrical Properties				
Frequency (MHz)	1176.45	1561	1575.42	1602
Gain(dB)	29.7	28.8	28.1	28.6
Noise Figure (dB)	2.9	2.8	2.9	2.3
Input Voltage (V)	+ 1.8 to 5.5			
Current consumption (mA)	5 ± 2			
IEC61000-4-2 (ESD protection)	± 30 kV air / ± 20Kv contact discharge			

Cellular Electrical									
Band	Frequency (MHz)	Antenna MIMO	Efficiency (%)	Average Gain (dB)	Peak Gain (dBi)	Impedance	Polarization	Radiation Pattern	Max. input power
5GNR/4G Band71	617-698	Cellular1	27.0	-5.69	2.03	50 Ω	Linear	Omni	10W
		Cellular2	20.4	-6.91	-1.50				
		Cellular3	25.6	-5.92	0.17				
		Cellular4	44.1	-3.56	3.54				
		Cellular5	24.9	-6.04	2.68				
		Cellular6	24.5	-6.11	-0.41				
		Cellular7	25.1	-6.00	-1.18				
		Cellular8	29.9	-5.24	0.85				
4G/3G Band 12,13,14,17,28,29	698-824	Cellular1	34.1	-4.67	2.63	50 Ω	Linear	Omni	10W
		Cellular2	32.0	-4.95	1.92				
		Cellular3	35.7	-4.48	2.67				
		Cellular4	42.9	-3.67	2.75				
		Cellular5	32.0	-4.95	1.77				
		Cellular6	26.4	-5.79	-0.11				
		Cellular7	32.9	-4.83	1.97				
		Cellular8	36.4	-4.39	2.24				
4G/3G/NB-IoT/Cat M Band 5,8,18,19,20,26,27	824-960	Cellular1	38.3	-4.16	1.52	50 Ω	Linear	Omni	10W
		Cellular2	36.0	-4.44	1.50				
		Cellular3	28.3	-5.48	1.20				
		Cellular4	35.5	-4.49	2.45				
		Cellular5	29.9	-5.24	1.53				
		Cellular6	28.7	-5.43	-0.35				
		Cellular7	36.3	-4.40	2.66				
		Cellular8	40.1	-3.97	2.58				
5GNR/4G Band 21,32,74,75,76	1427-1518	Cellular1	37.4	-4.27	2.73	50 Ω	Linear	Omni	10W
		Cellular2	41.9	-3.78	3.32				
		Cellular3	33.1	-4.81	2.78				
		Cellular4	32.9	-4.82	2.33				
		Cellular5	31.2	-5.06	2.10				
		Cellular6	31.5	-5.01	1.43				
		Cellular7	39.7	-4.02	2.25				
		Cellular8	25.7	-5.91	0.94				
4G/3G Band 1,2,3,4,9,23,25,35,39,66	1710-2200	Cellular1	46.4	-3.34	4.93	50 Ω	Linear	Omni	10W
		Cellular2	47.2	-3.26	4.61				
		Cellular3	51.5	-2.88	5.48				
		Cellular4	48.7	-3.13	5.34				
		Cellular5	51.5	-2.88	6.07				
		Cellular6	49.3	-3.07	6.07				
		Cellular7	29.8	-5.26	4.22				
		Cellular8	31.3	-5.04	2.93				
4G/3G Band 7,30,38,40,41	2300-2690	Cellular1	49.9	-3.02	5.47	50 Ω	Linear	Omni	10W
		Cellular2	48.3	-3.16	4.39				
		Cellular3	48.2	-3.17	6.12				
		Cellular4	38.8	-4.12	6.69				
		Cellular5	39.2	-4.07	5.96				
		Cellular6	49.2	-3.08	6.79				
		Cellular7	39.7	-4.01	5.28				
		Cellular8	43.1	-3.65	6.09				
5GNR/4G Band 22,42,48,77,78,79	3300-5000	Cellular1	51.4	-2.89	6.13	50 Ω	Linear	Omni	10W
		Cellular2	44.9	-3.48	7.46				
		Cellular3	47.4	-3.24	5.75				
		Cellular4	48.2	-3.17	6.88				
		Cellular5	42.5	-3.72	5.24				
		Cellular6	46.2	-3.35	5.90				
		Cellular7	43.1	-3.65	5.37				
		Cellular8	46.1	-3.36	6.02				
LTE5200/Wi-Fi5800	5150-5925	Cellular1	43.2	-3.65	7.96	50 Ω	Linear	Omni	10W
		Cellular2	42.7	-3.69	7.82				
		Cellular3	43.4	-3.63	5.67				
		Cellular4	46.5	-3.33	5.73				
		Cellular5	42.7	-3.70	5.26				
		Cellular6	43.6	-3.61	5.84				
		Cellular7	40.1	-3.97	6.03				
		Cellular8	44.6	-3.50	6.14				

Wi-Fi Electrical									
Band	Frequency (MHz)	Antenna MIMO	Efficiency (%)	Average Gain (dB)	Peak Gain (dBi)	Impedance	Polarization	Radiation Pattern	Max. input power
Wi-Fi - 2GHz	2400-2500	Wi-Fi1	56.5	-2.48	4.36	50 Ω	Linear	Omni	10W
		Wi-Fi2	58.2	-2.35	6.55				
		Wi-Fi3	56.1	-2.51	5.68				
		Wi-Fi4	58.1	-2.36	4.19				
		Wi-Fi5	53.3	-2.73	7.60				
		Wi-Fi6	52.7	-2.78	6.98				
Wi-Fi - 5GHz	5150-5850	Wi-Fi1	49.3	-3.07	5.71				
		Wi-Fi2	49.5	-3.05	7.47				
		Wi-Fi3	47.8	-3.20	5.63				
		Wi-Fi4	45.9	-3.38	6.10				
		Wi-Fi5	50.5	-2.97	8.04				
		Wi-Fi6	44.7	-3.50	8.51				
Wi-Fi - 6GHz	5925-7125	Wi-Fi1	47.1	-3.27	6.33				
		Wi-Fi2	49.9	-3.02	7.47				
		Wi-Fi3	48.4	-3.15	6.28				
		Wi-Fi4	43.1	-3.66	5.96				
		Wi-Fi5	46.2	-3.36	7.31				
		Wi-Fi6	43.7	-3.60	7.22				

Mechanical	
Dimensions	330 x 75.5 x 45.2mm
Material	PC
Connector	SMA(M) and RP-SMA(M) - See Page 8 for more details
Cable	RG-174 and TGC-1.5DS - See Page 8 for more details
IK Impact Rating	IK08 – 5 Joules / 1.7Kg dropped from 300mm
Weight	972g

Environmental	
Temperature Range	-40 - +85°C
Relative Humidity	Non-condensing 65°C 95% RH
Ingress Protection	IP67
RoHS & REACH Compliant	Yes

3. Mechanical Drawing

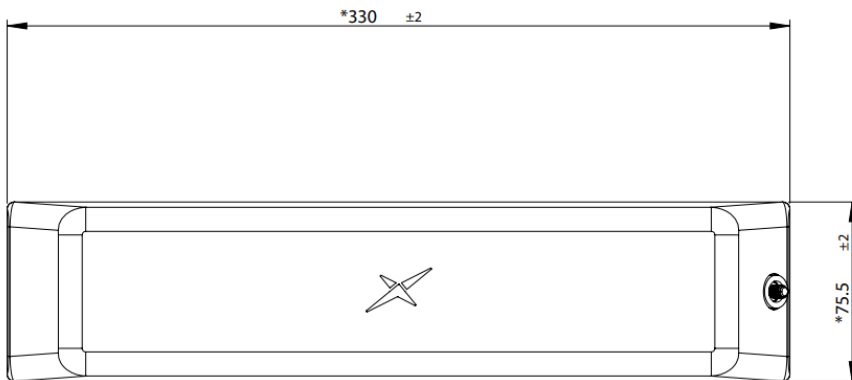

DETAIL A
SCALE 1.5 : 1



DETAIL B
SCALE 1.5 : 1

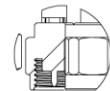

DETAIL C
SCALE 1.5 : 1

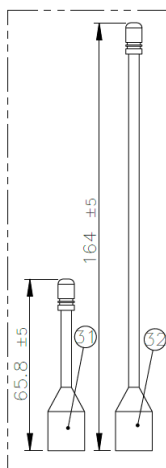
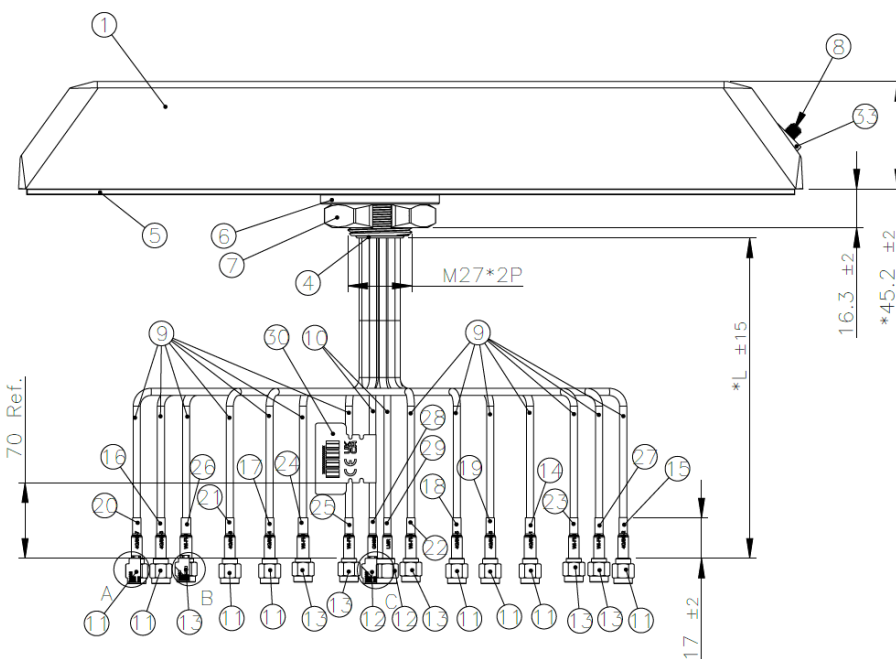

Whip antennas

Cable length from base	
Cable P/N	L
4G-5G -1	300
4G-5G -2	275
4G-5G -3	275
4G-5G -4	250
4G-5G -5	200
4G-5G -6	200
4G-5G -7	225
4G-5G -8	225
WiFi-1	250
WiFi-2	225
WiFi-3	225
WiFi-4	200
WiFi-5	200
WiFi-6	325
GNSS	300
LMR	325

	Name	Material	Finish	Qty
1	Top housing	PC	White	1
2	Bottom housing	PC+10%GF/Sab ic 505RU	MT9050, White	1
3	Metal Stem	Zinc Alloy	Ni Plated	1
4	Grommet	Silicone Rubber	Black	1
5	Double Side Adhesive	3M 9448HK + CR4305 2t	Black	1
6	washer(ID28*OD50 t4.0)	S45C	Ni-Zn Plated	1
7	M27*P2.0mm steel Nut	S45C	Ni-Zn Plated	1
8	M6*0.75P screw	Brass	Ni Plated	1
9	TGC-1.5DS Coaxial Cable	PE	Black	14
10	RG174 Coaxial Cable	PE	Black	2
11	SMA(M)ST Plug for low loss1.5DS	Brass	Au Plated	8
12	SMA(M)ST Plug	Brass	Au Plated	2
13	SMA(M)ST_RP low loss 1.5DS	Brass	AU PLATING	6
14	Heat Shrink Tube(4G/5G-1)	PE	Red Tube/White Text	1
15	Heat Shrink Tube(4G/5G-2)	PE	Red Tube/White Text	1
16	Heat Shrink Tube(4G/5G-3)	PE	Red Tube/White Text	1
17	Heat Shrink Tube(4G/5G-4)	PE	Red Tube/White Text	1
18	Heat Shrink Tube(4G/5G-5)	PE	Red Tube/White Text	1
19	Heat Shrink Tube(4G/5G-6)	PE	Red Tube/White Text	1
20	Heat Shrink Tube(4G/5G-7)	PE	Red Tube/White Text	1
21	Heat Shrink Tube(4G/5G-8)	PE	Red Tube/White Text	1
22	Heat Shrink Tube (WiFi-1)	PE	Yellow tube/ Black text	1
23	Heat Shrink Tube (WiFi-2)	PE	Yellow Tube/Black Text	1
24	Heat Shrink Tube (Wi- Fi-3)	PE	Yellow Tube /Black Text	1
25	Heat Shrink Tube (Wi- Fi-4)	PE	Yellow Tube /Black Text	1
26	Heat Shrink Tube (Wi- Fi-5)	PE	Yellow Tube /Black Text	1
27	Heat Shrink Tube (Wi- Fi-6)	PE	Yellow Tube /Black Text	1
28	Heat Shrink Tube(GNSS)	PE	Blue Tube/White Text	1
29	Heat Shrink Tube(LMR)	PE	Green Tube/White Text	1
30	CE,WEEE and UKCA mark logo Label	PEPA	White	1
31	Flexible Whip Antenna 700-900MHz	PVC	White	1
32	Flexible Whip Antenna 380-400MHz	PVC	White	1
33	Foam adhesive	Silicone Rubber	White	1

4. Packaging

1pc Small Whip per PE Bag



1pc Large Whip per PE Bag



1pc Antenna per Large PE Bag
 Bag Dimensions: 470x470mm
 Weight: 0.58Kg



8pcs per Carton
 Carton Dimensions: 370x370x300mm
 Weight: 6.1Kg



5. Installation Recommendation

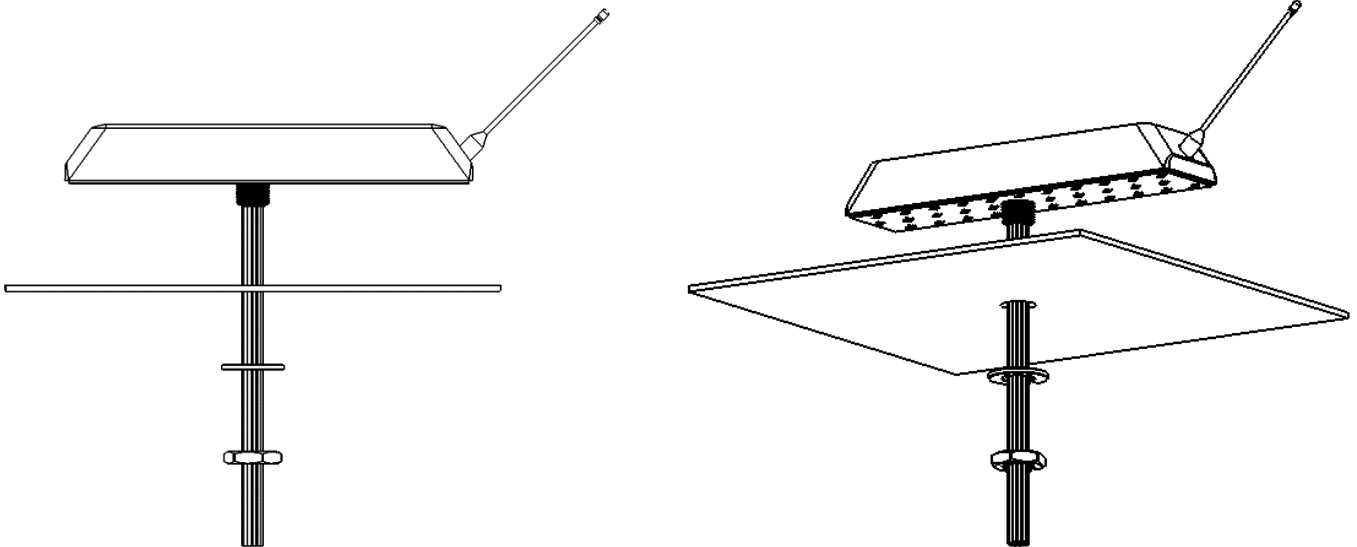

Correct installation of the Raptor Max is required to ensure that the waterproof integrity of the vehicle or enclosure is not compromised.

Step 1: Drill the recommended 30mm diameter hole as indicated below.

Step 2: Ensure that the surface you are mounting to is clean, dry and flat to receive the Raptor Max.

Step 3: Feed the cables through the hole and remove the 3m adhesive backing from the base.

Step 4: Position the Raptor Max into the correct orientation on the mounting surface and firmly press down to activate the 3M adhesive.

Step 5: To permanently mount the antenna, slide the washer and nut over the cable assembly and hand tighten to ensure a secure fit.

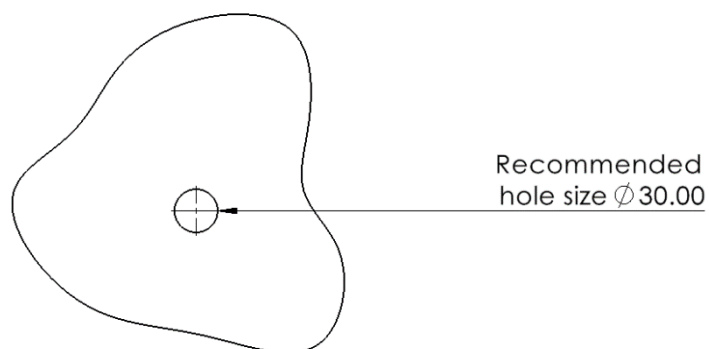

6. Antenna Characteristics

6.1 Test Setup

AUT



Vector Network Analyzer

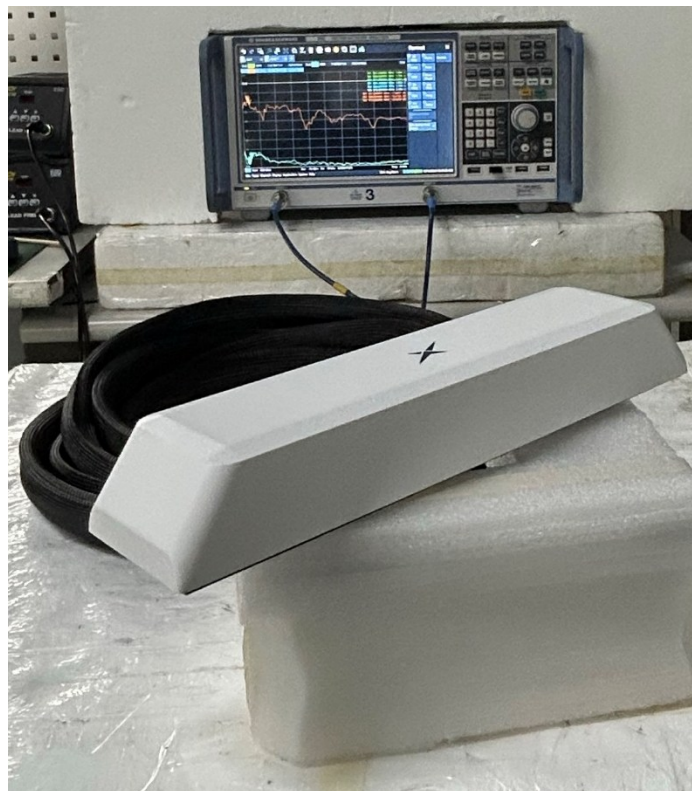

VNA Test Set-up

6.2 GNSS - Return Loss

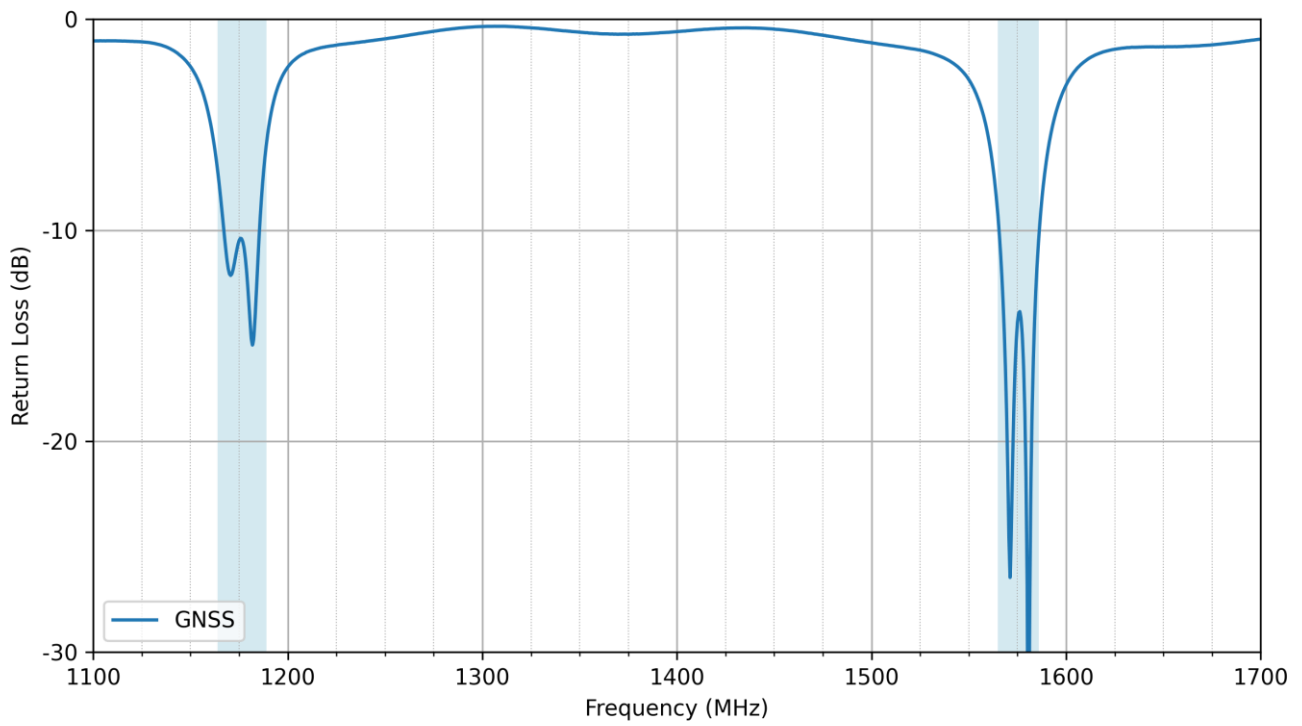

6.3 GNSS - VSWR

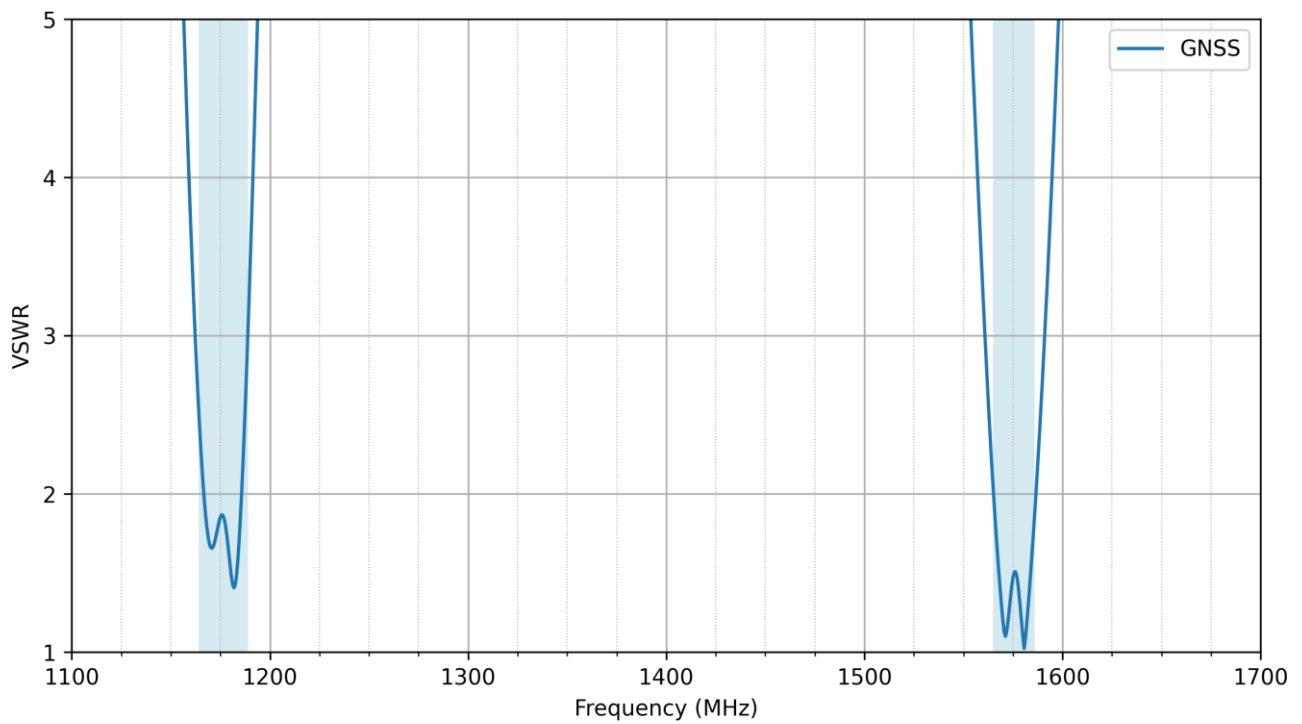

6.4 GNSS - Efficiency

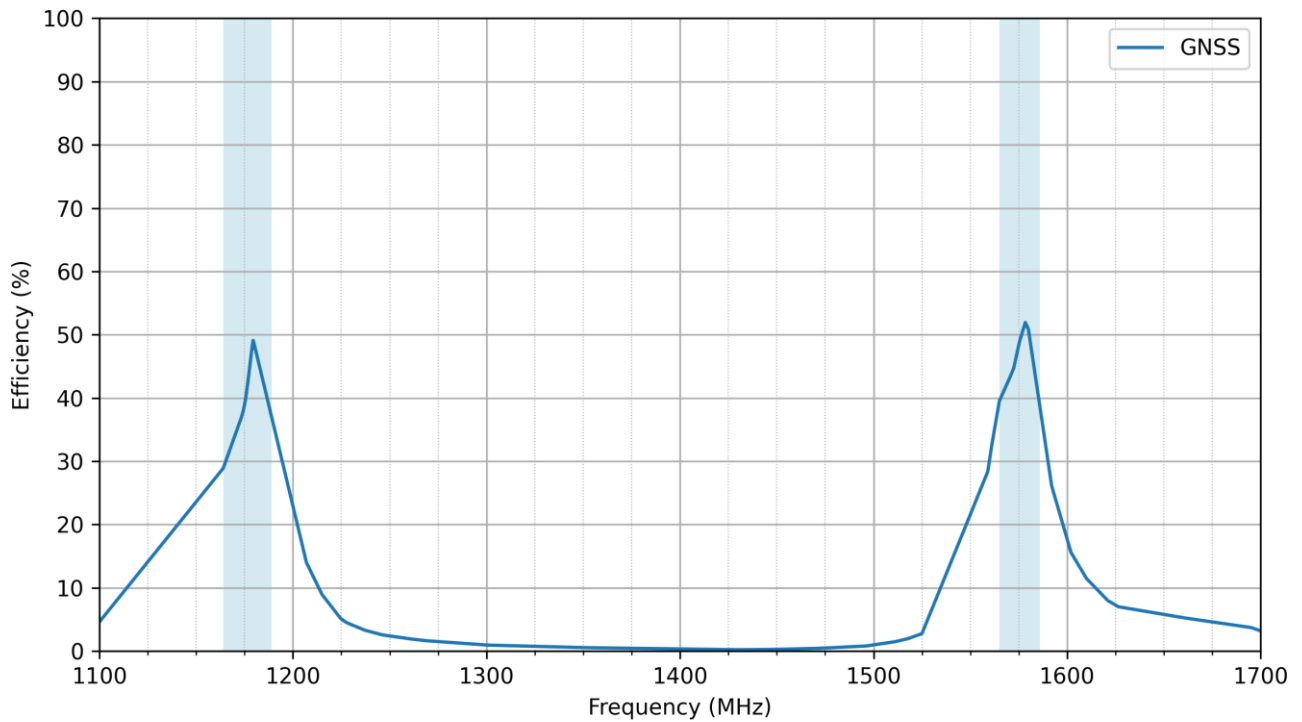

6.5 GNSS - Average Gain

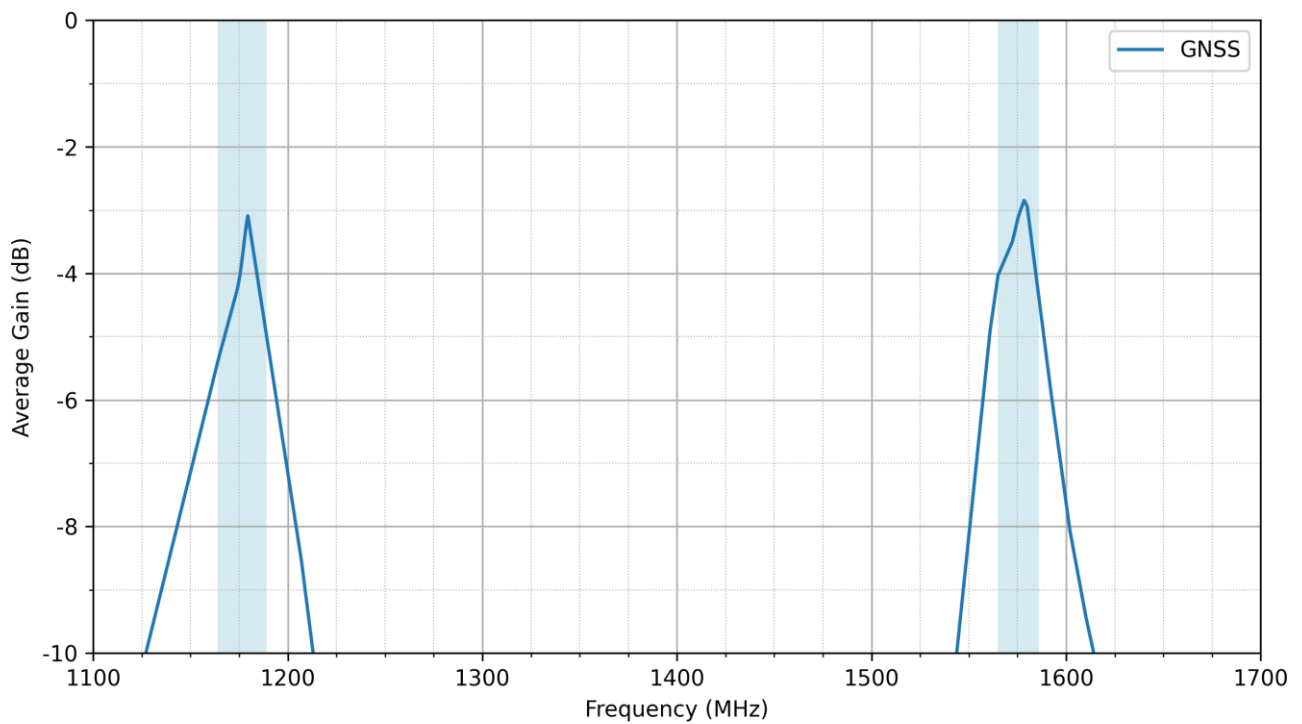

6.6 GNSS - Peak Gain

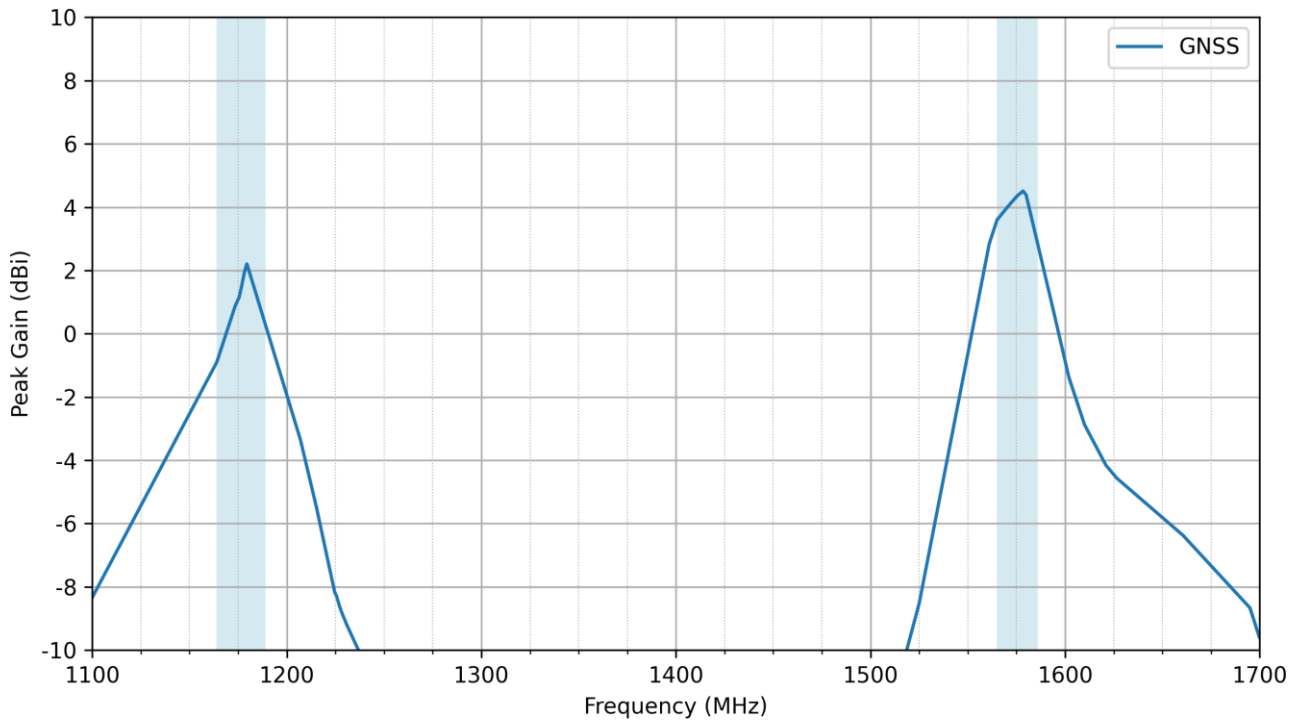

6.7 Cellular - Return Loss

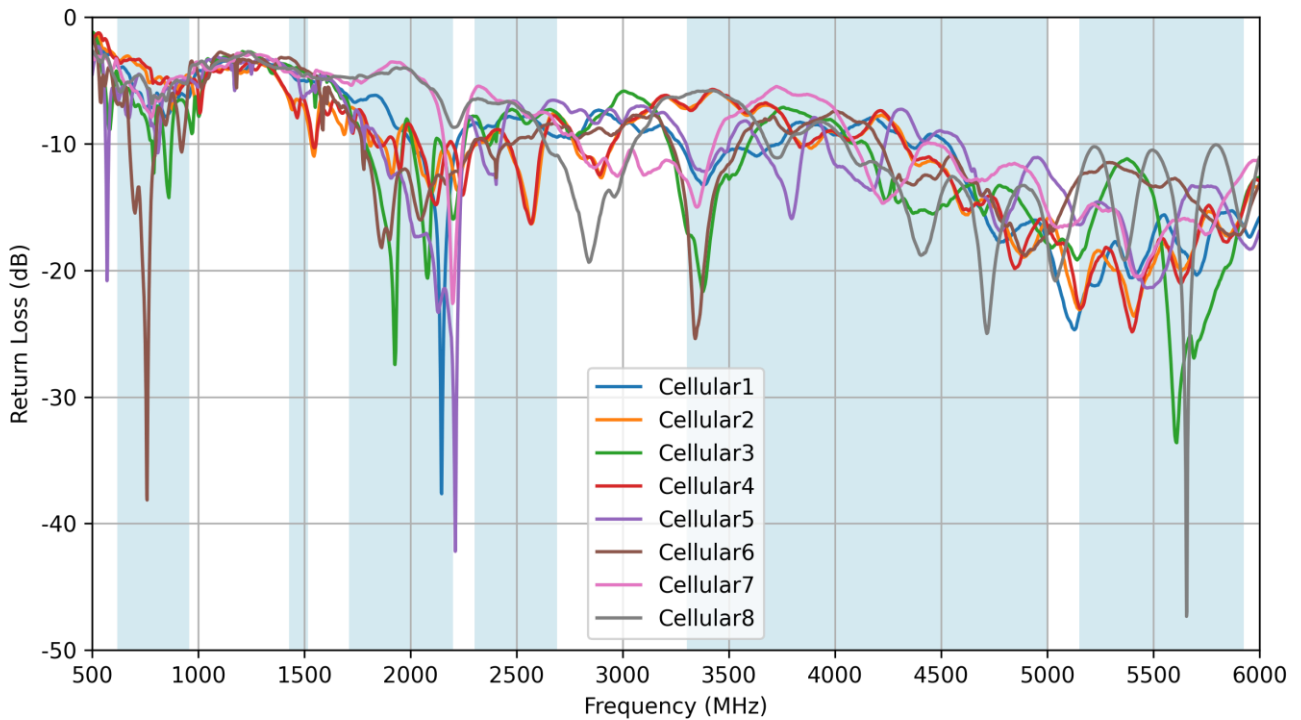

6.8 Cellular - VSWR

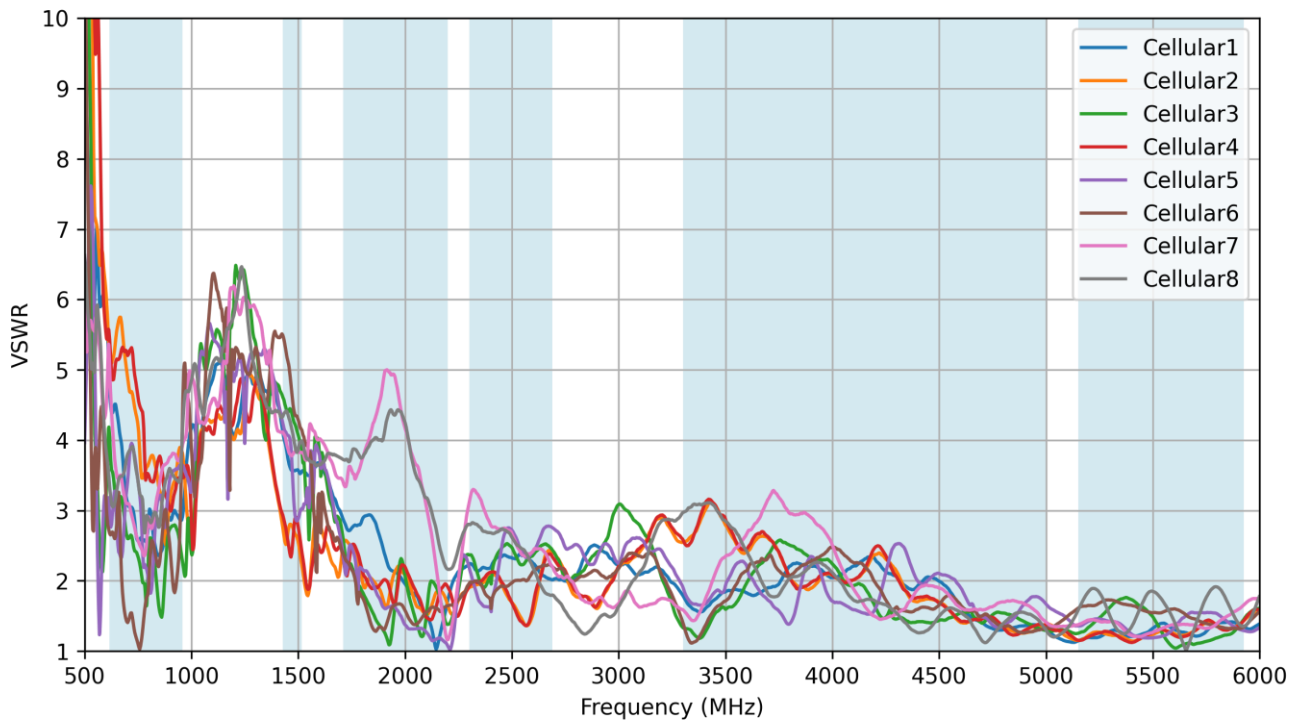

6.9 Isolation

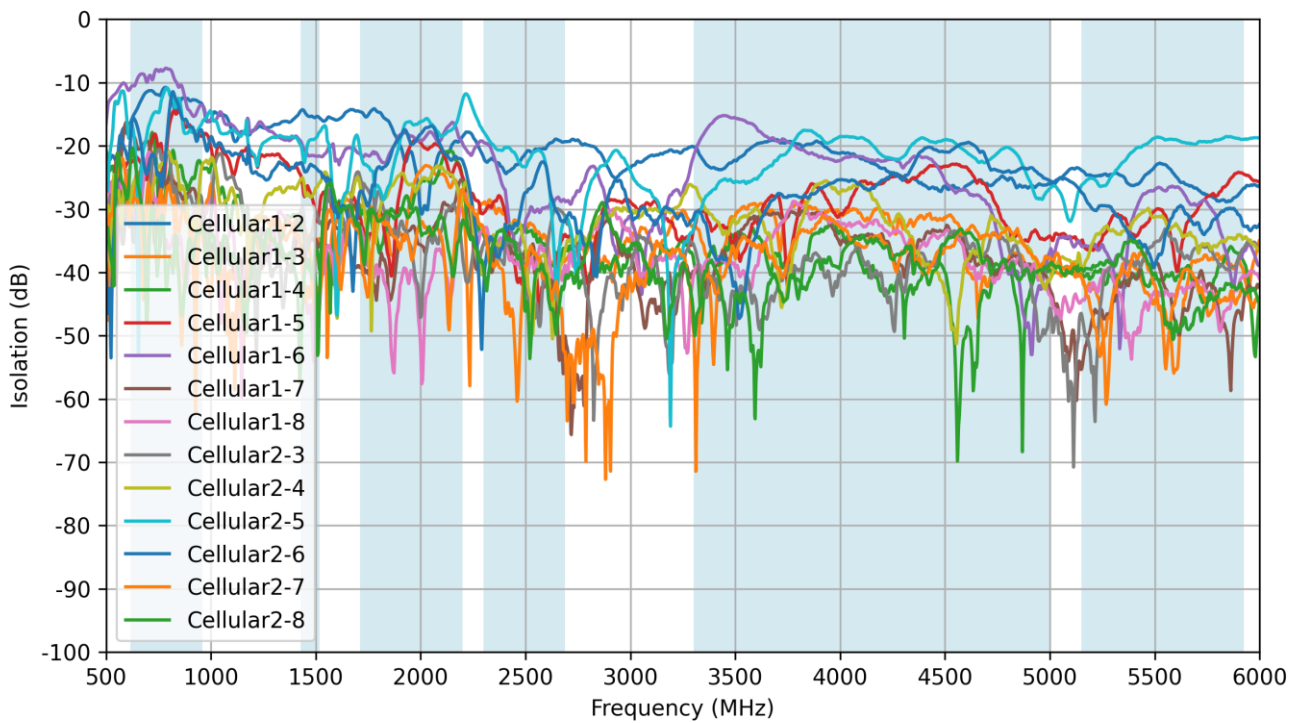

6.10 Isolation

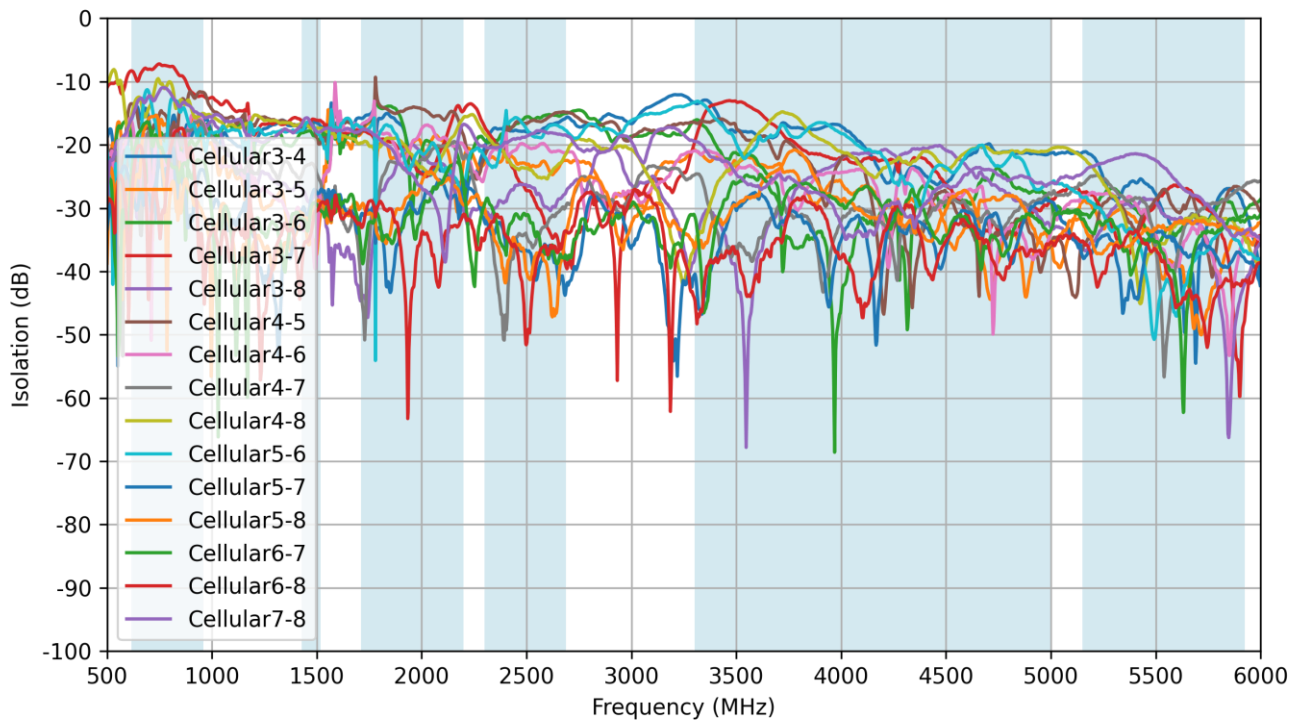

6.11 Cellular - Efficiency

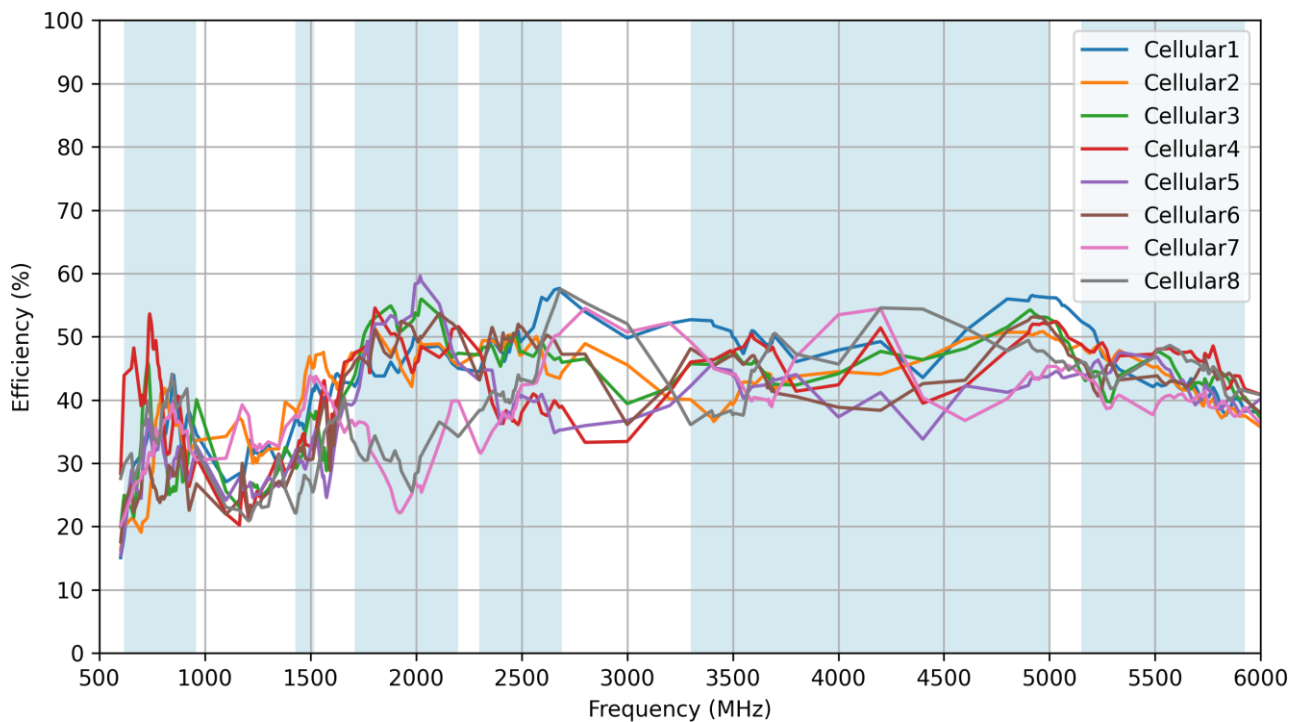

6.12 Cellular - Average Gain

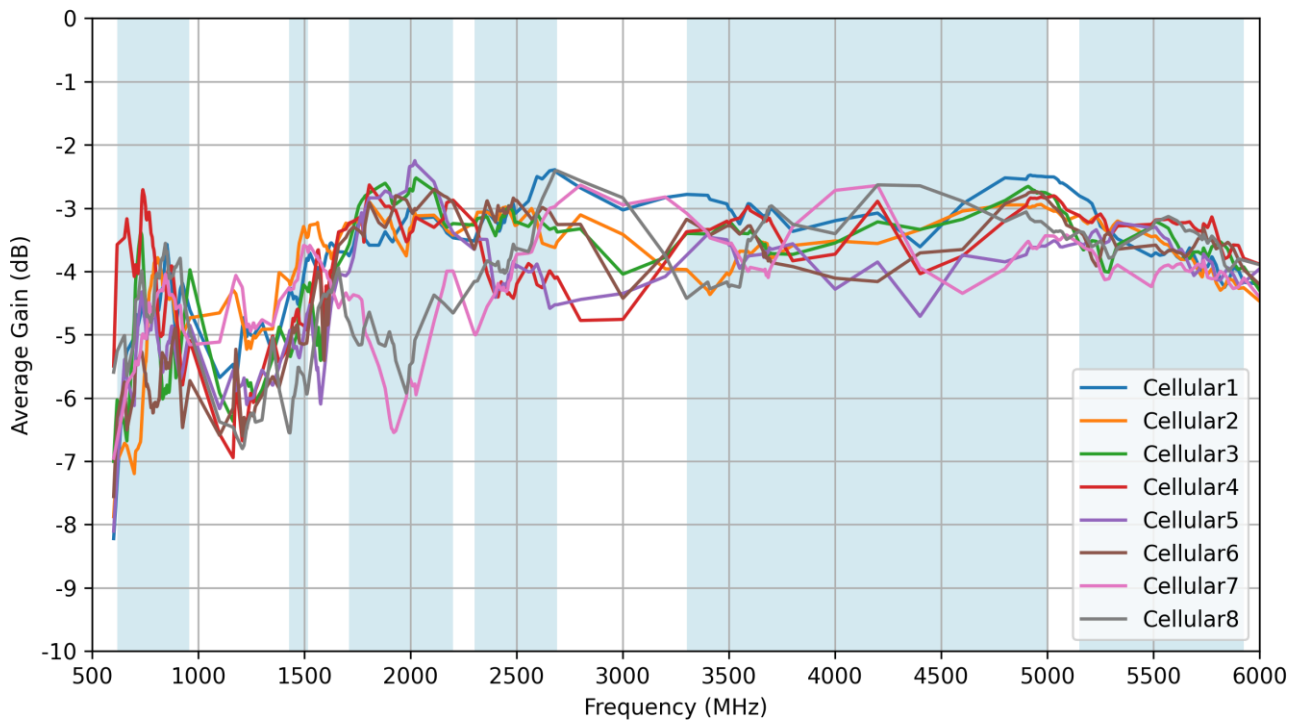

6.13 Cellular - Peak Gain

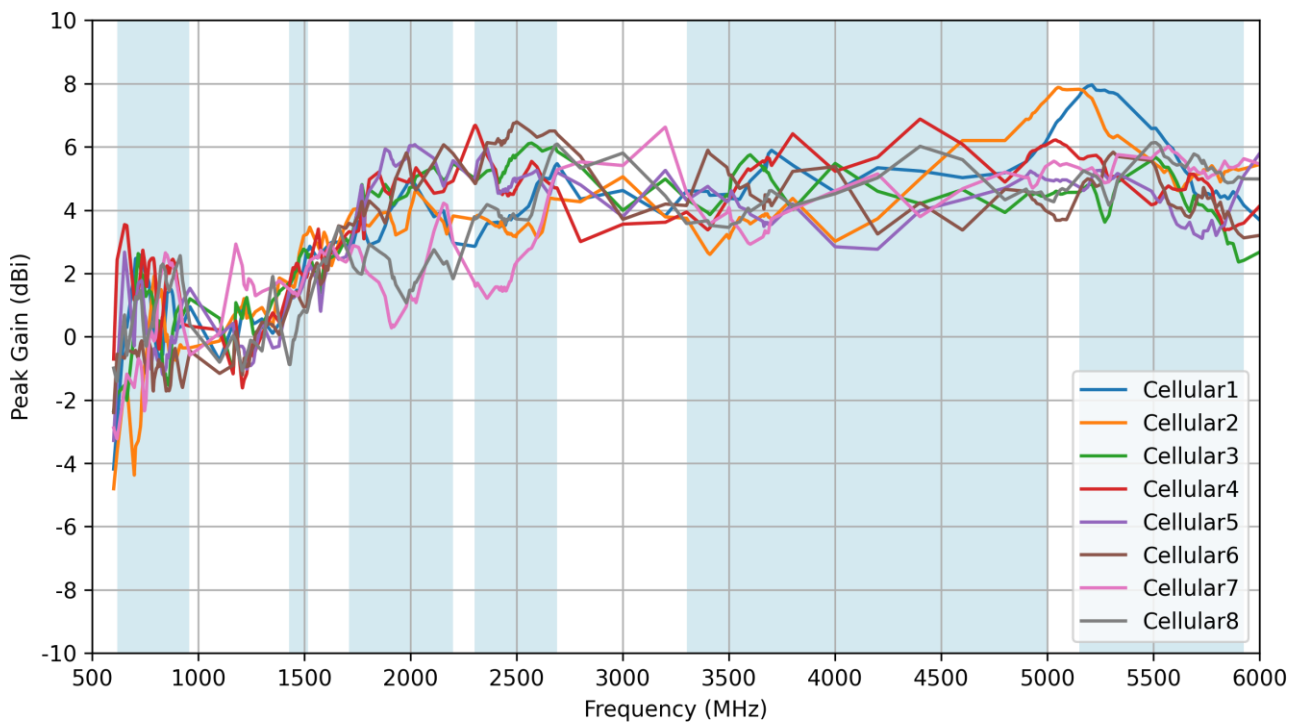

6.14 Wi-Fi - Return Loss

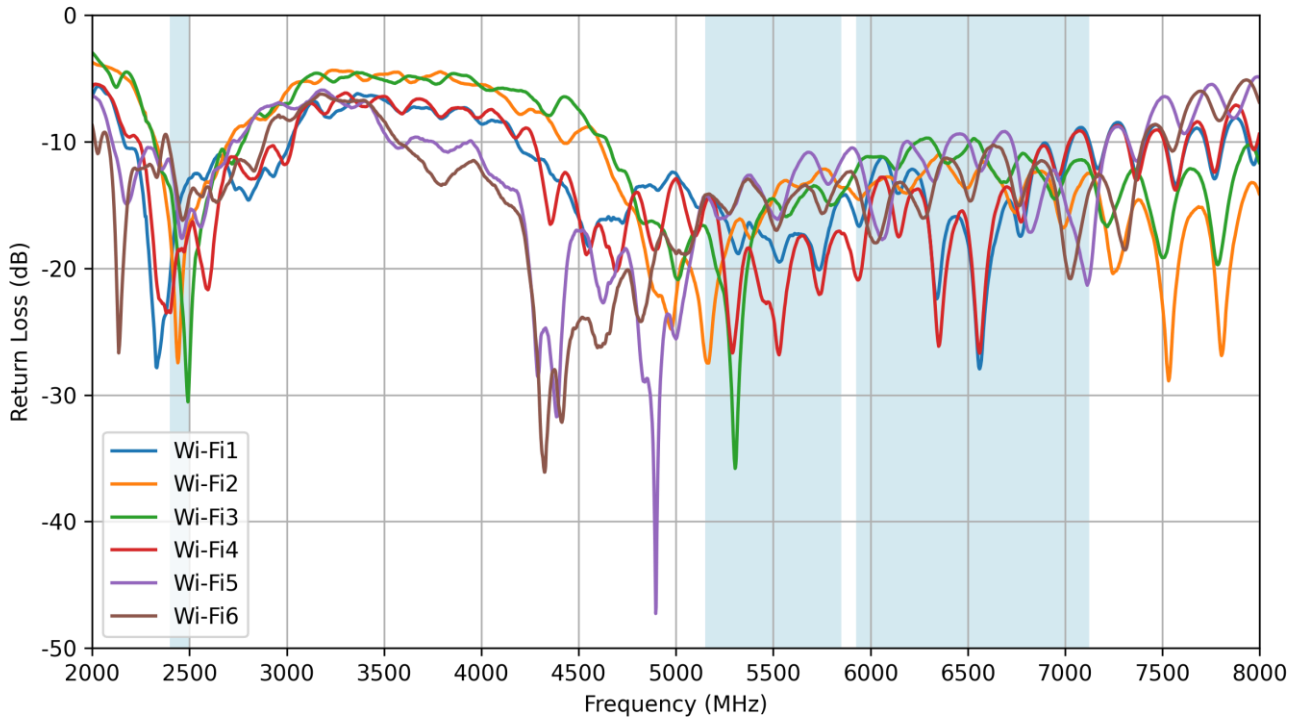

6.15 Wi-Fi - VSWR

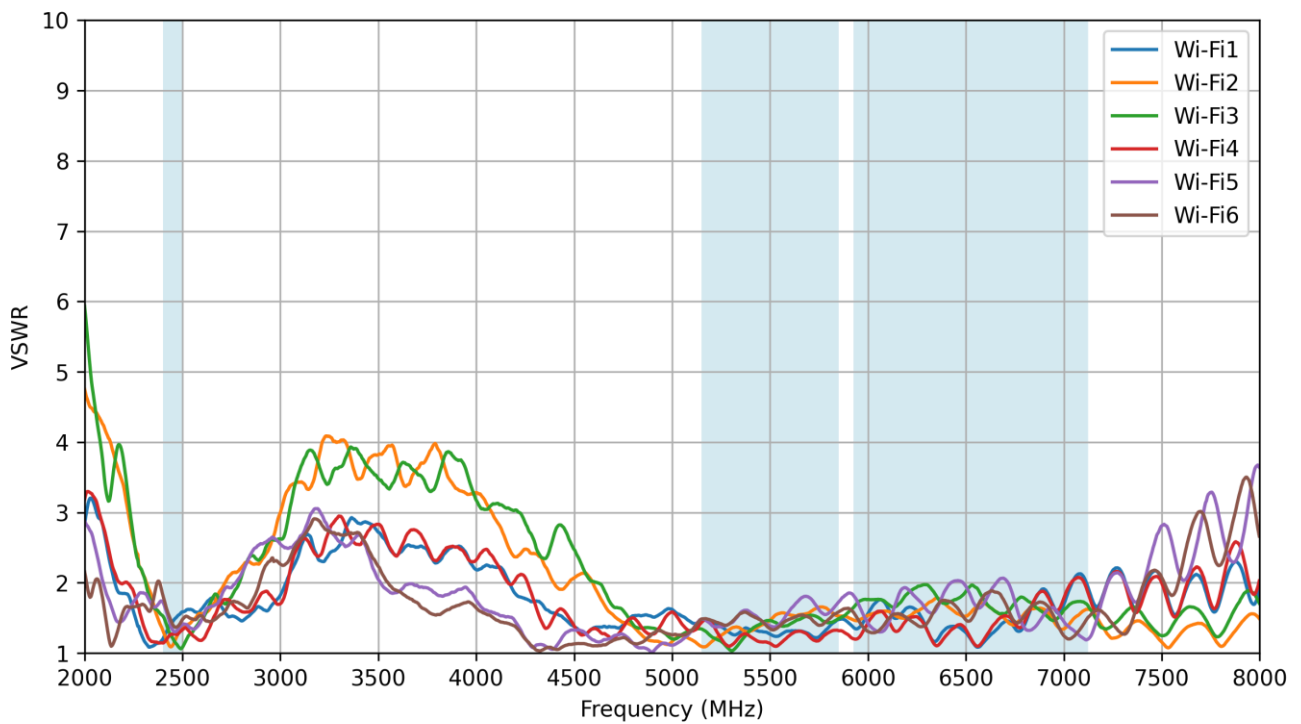

6.16 Wi-Fi - Isolation

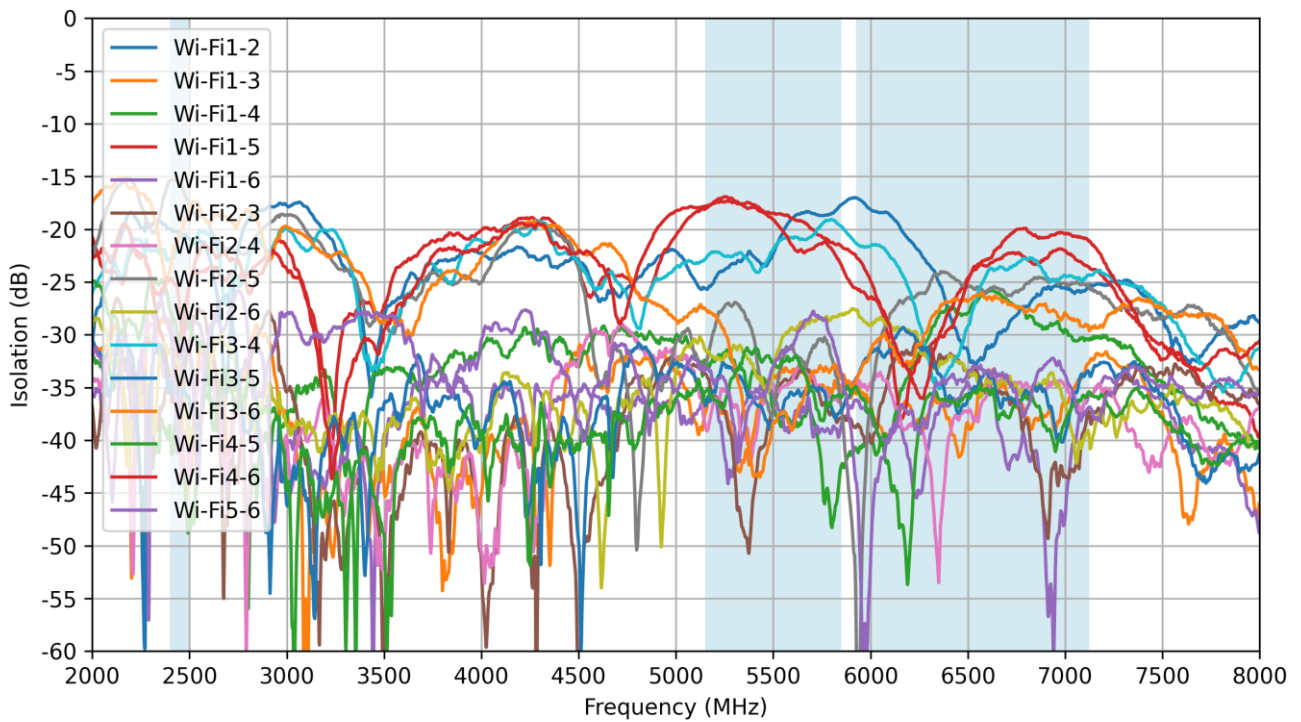

6.17 Wi-Fi - Efficiency

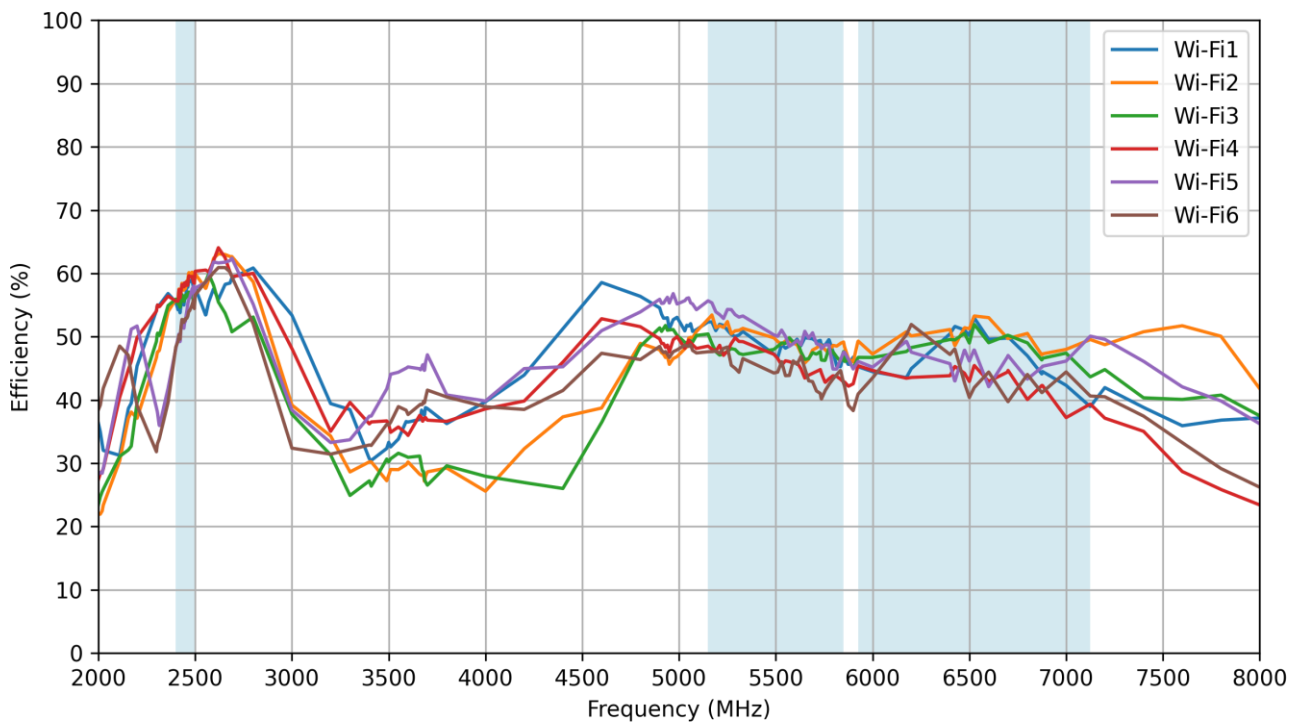

6.18 Wi-Fi - Average Gain

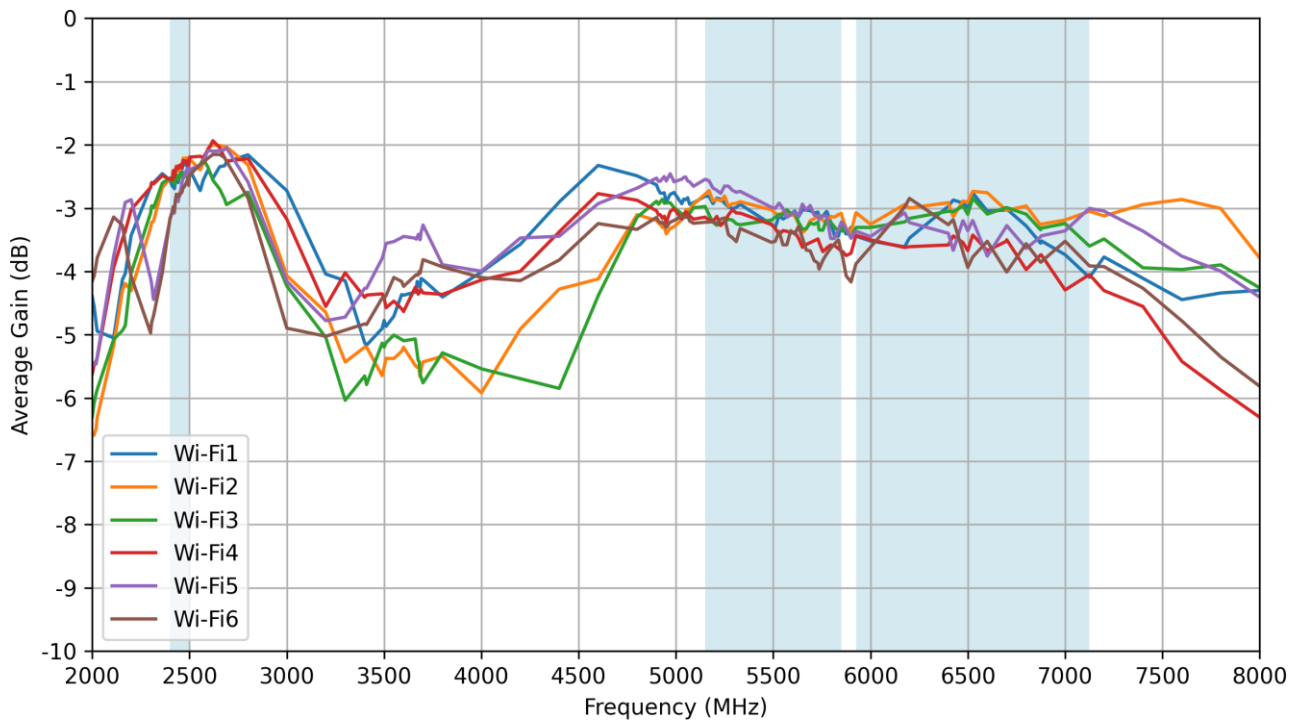

6.19 Wi-Fi - Peak Gain

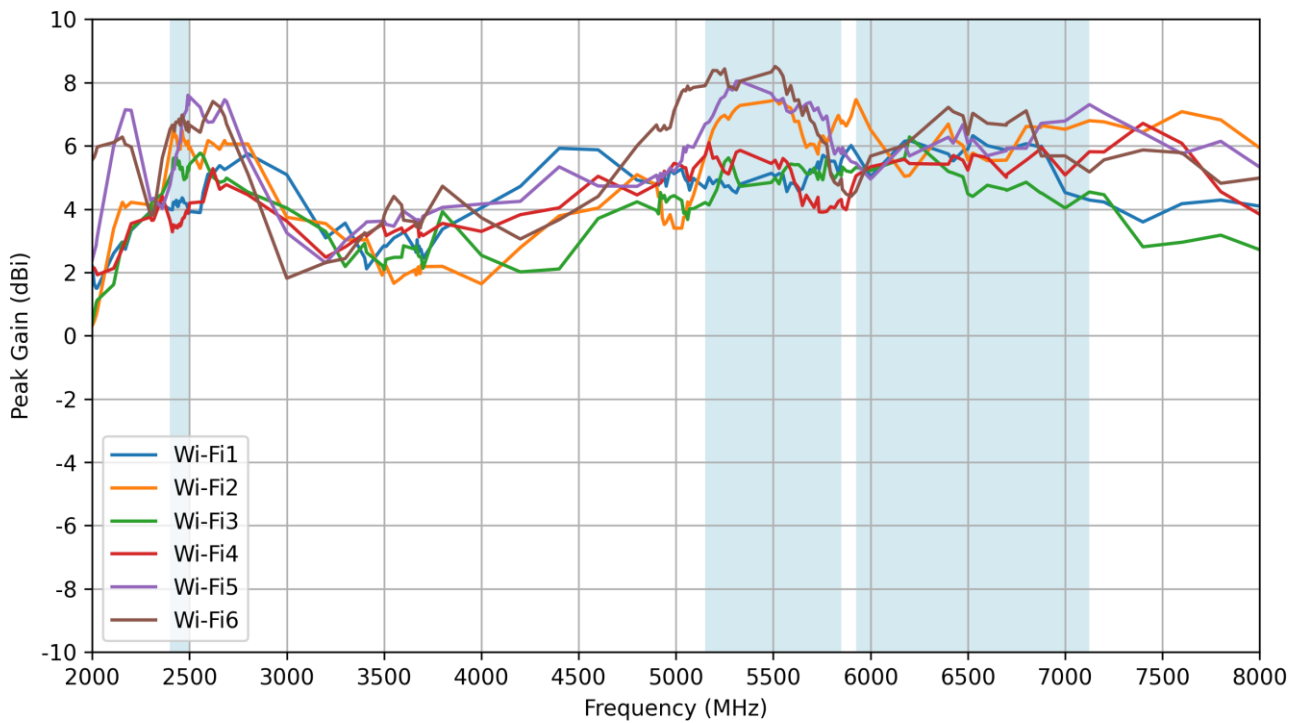

6.20 LMR

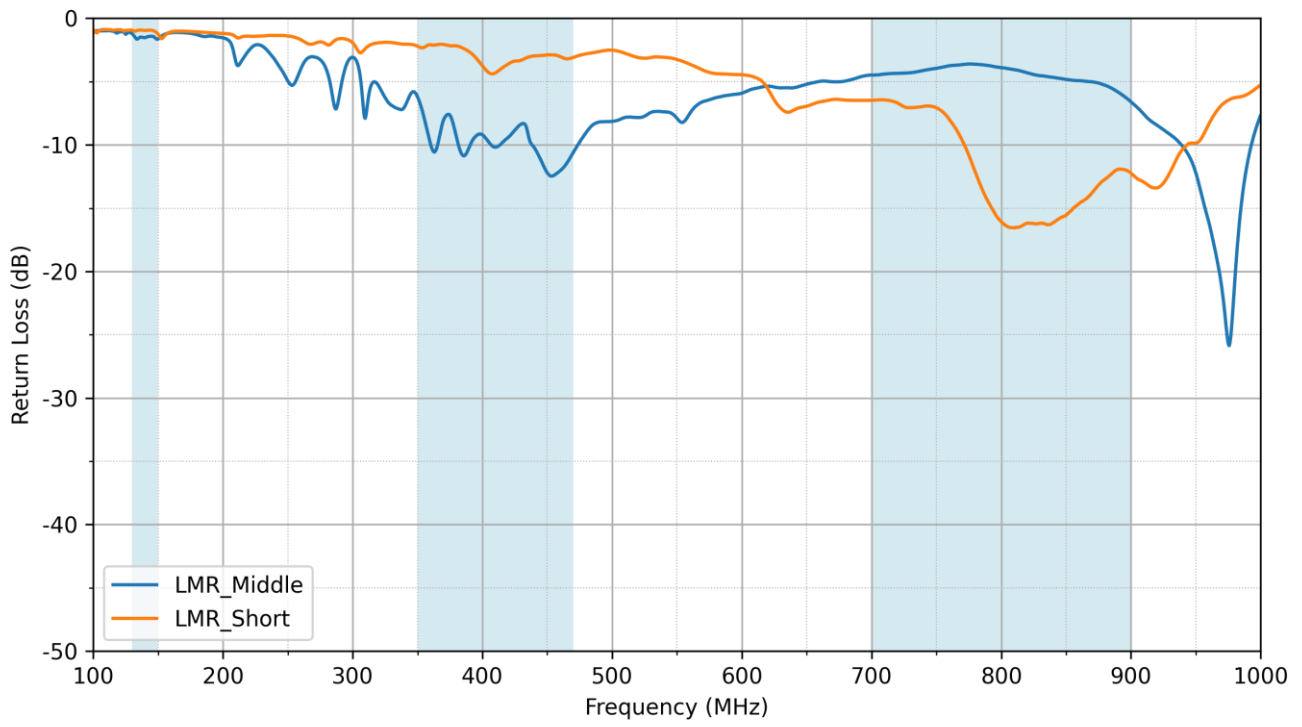

7. Active Antenna Characteristics

7.1 Block Diagram

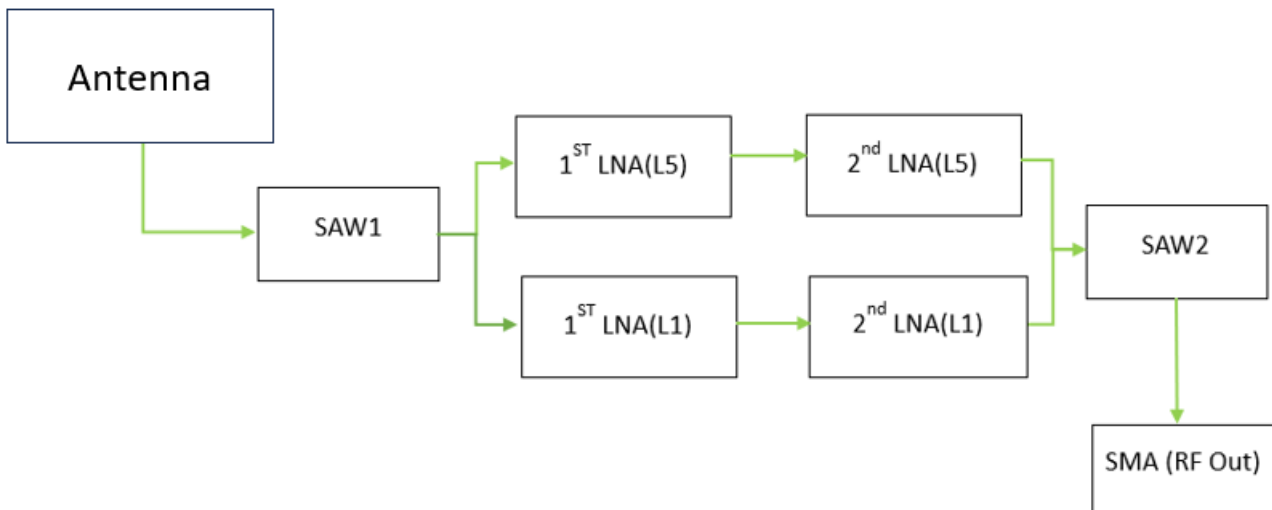

7.2 Noise Figure – Low-Band

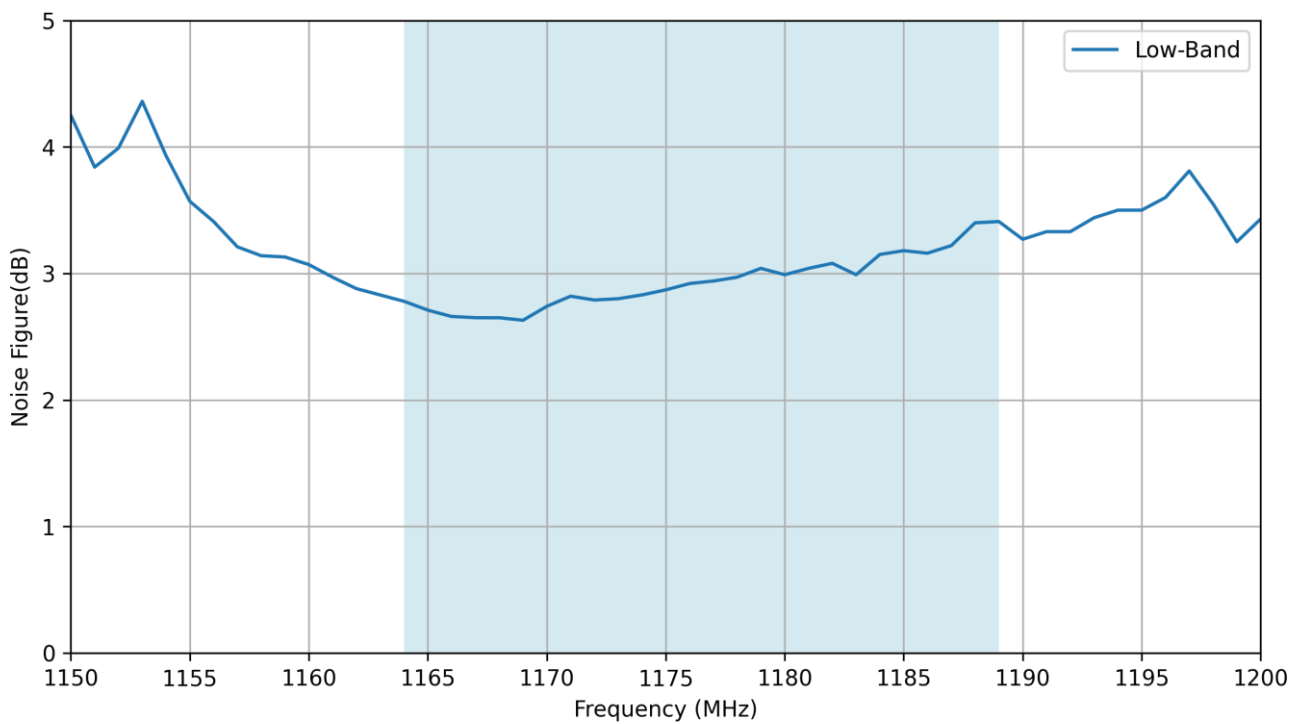

7.3 Noise Figure – High-Band

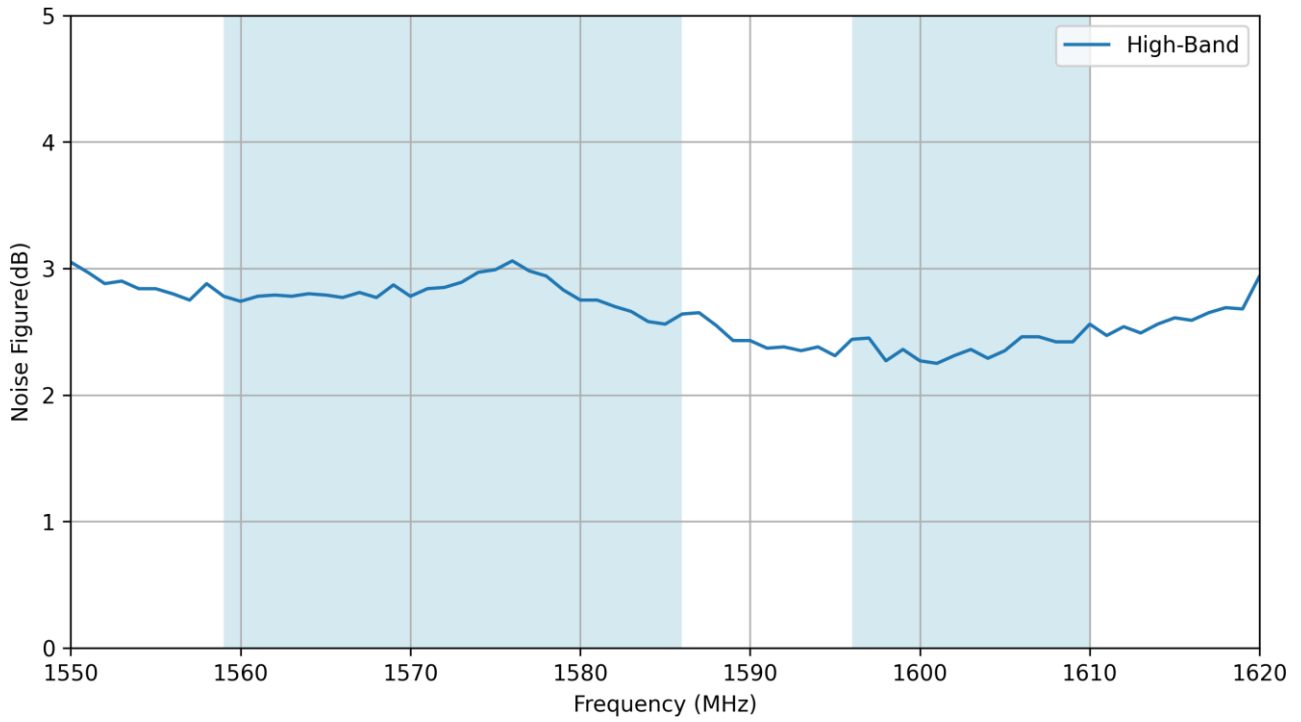

7.4 Gain – Low-Band

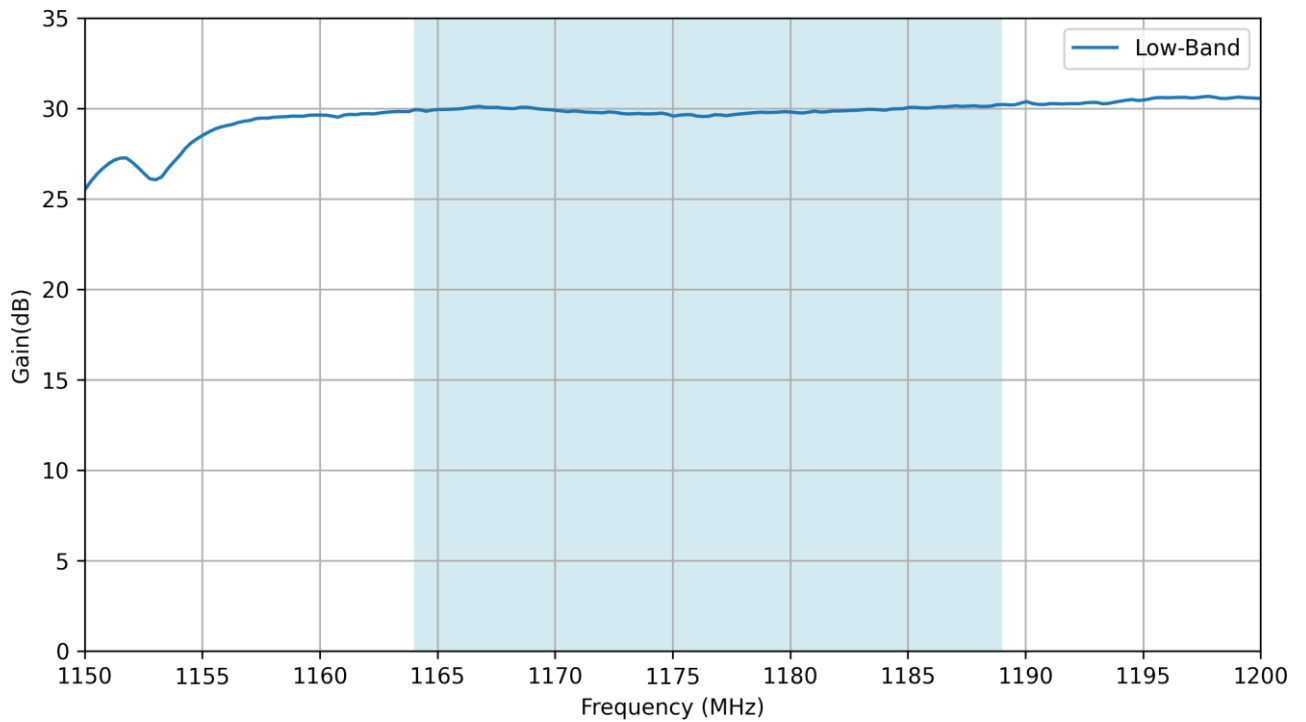

7.5 Gain – High-Band

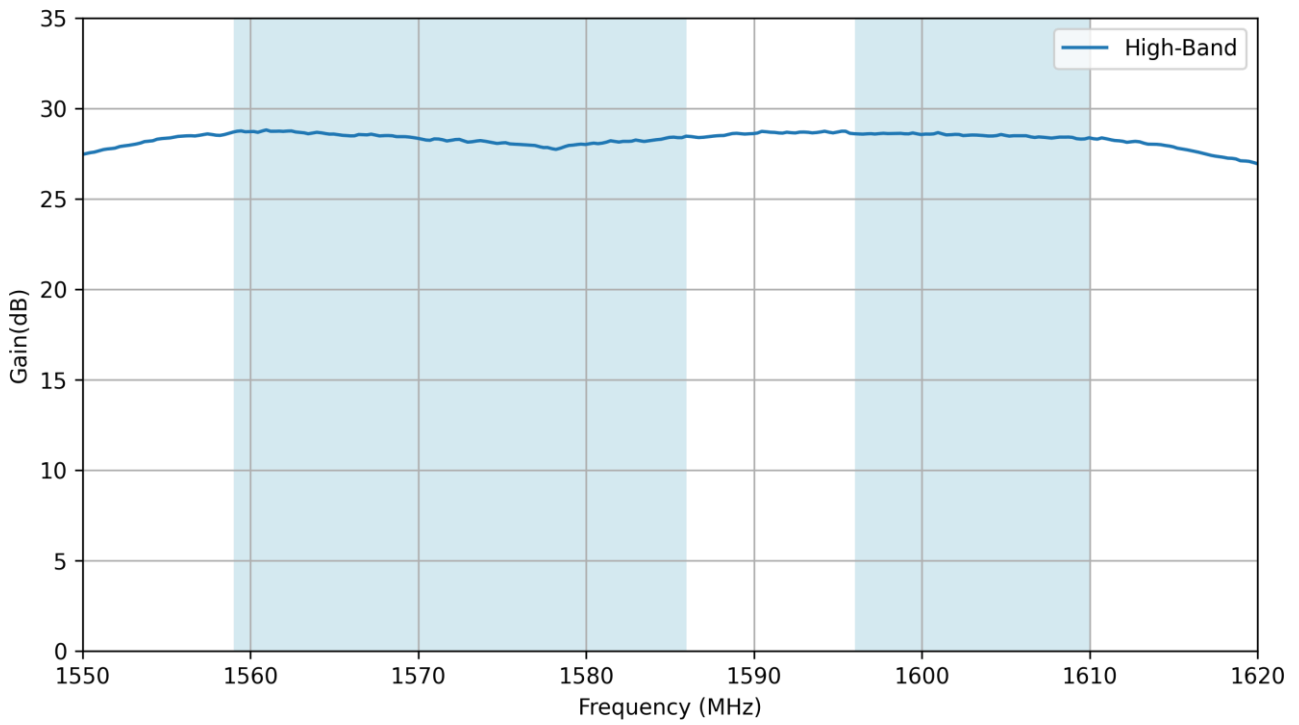

7.6 Gain – Wide-Band

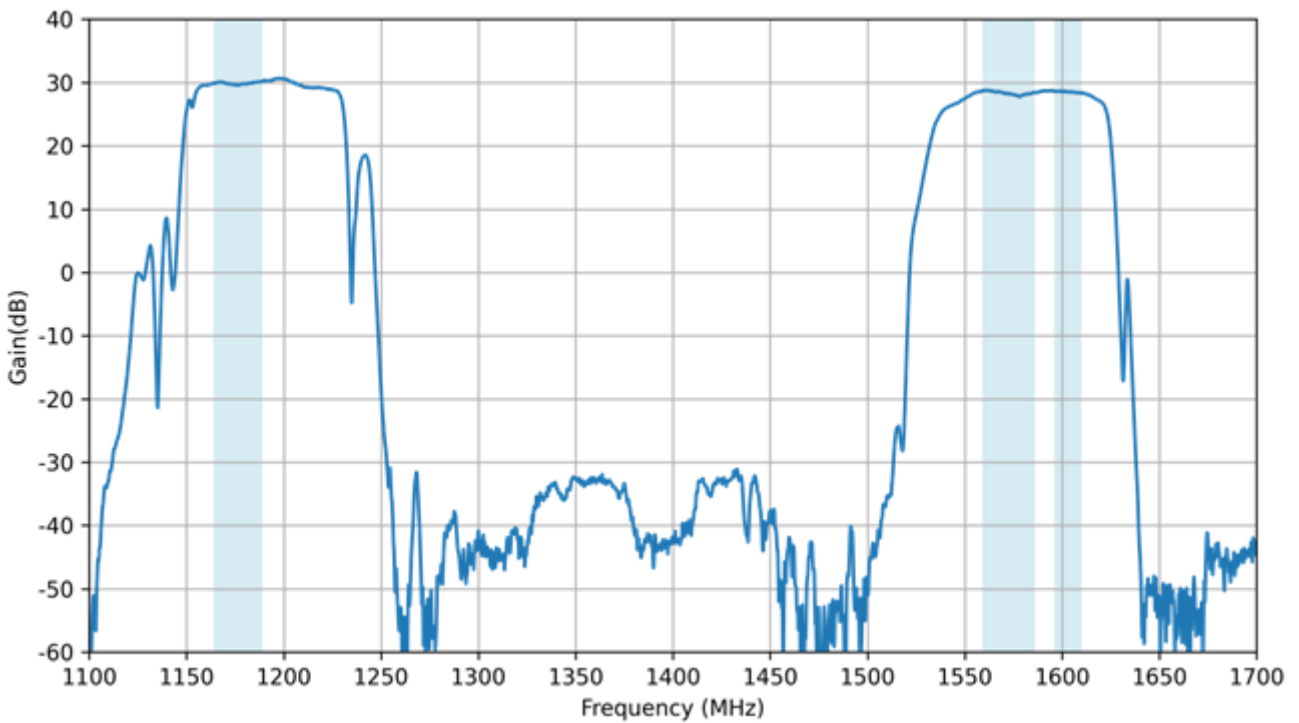

7.7 Out Of Band Rejection

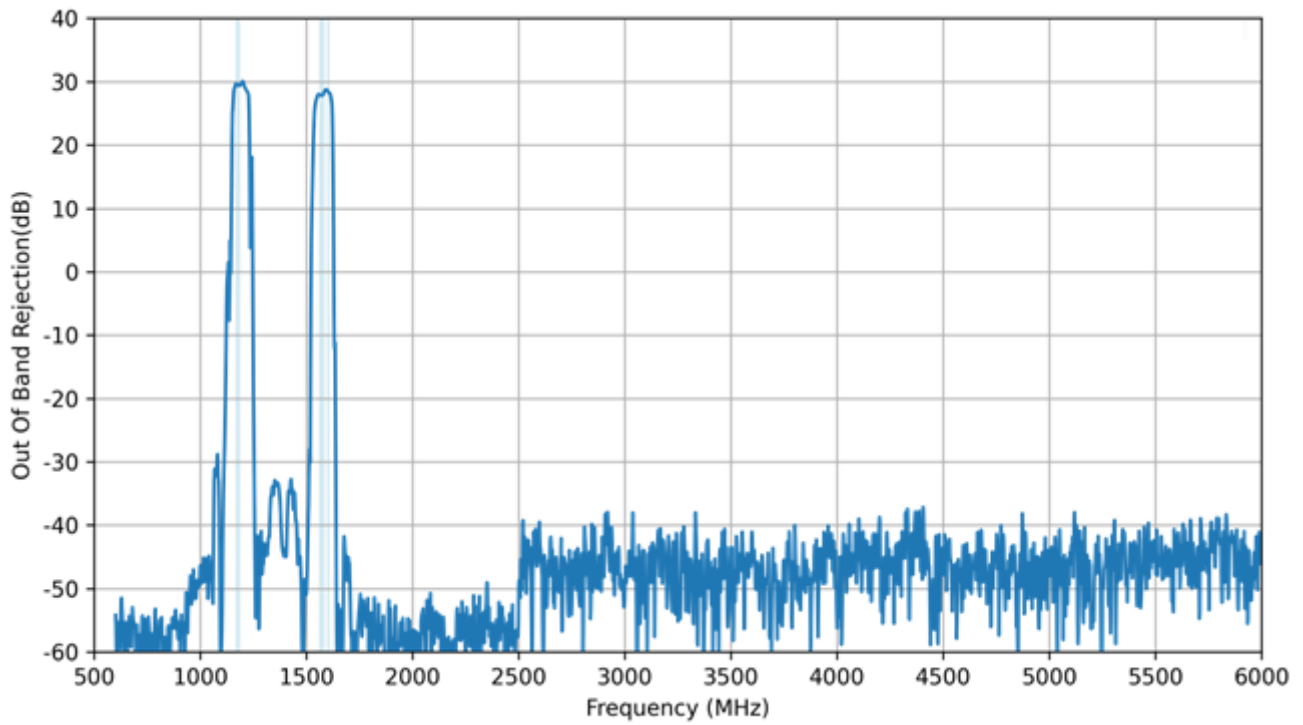

7.8 Group Delay - High-Band

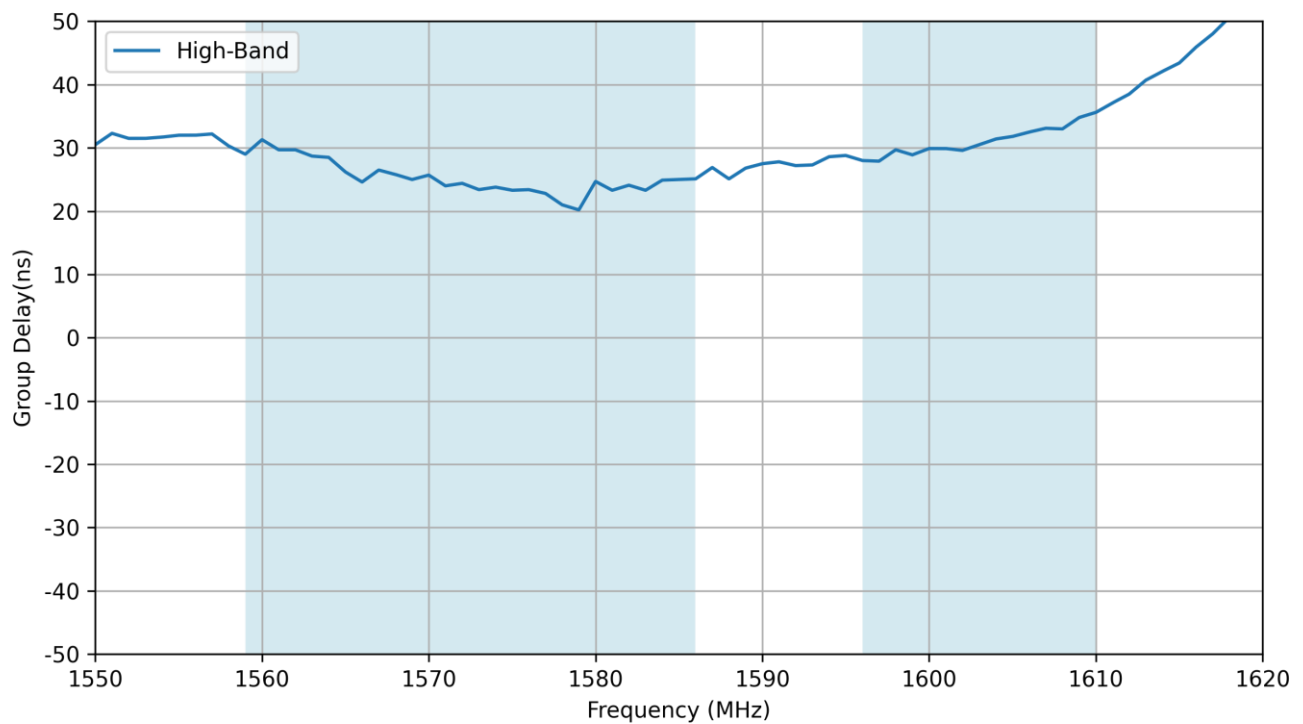

7.9 Group Delay - Low-Band

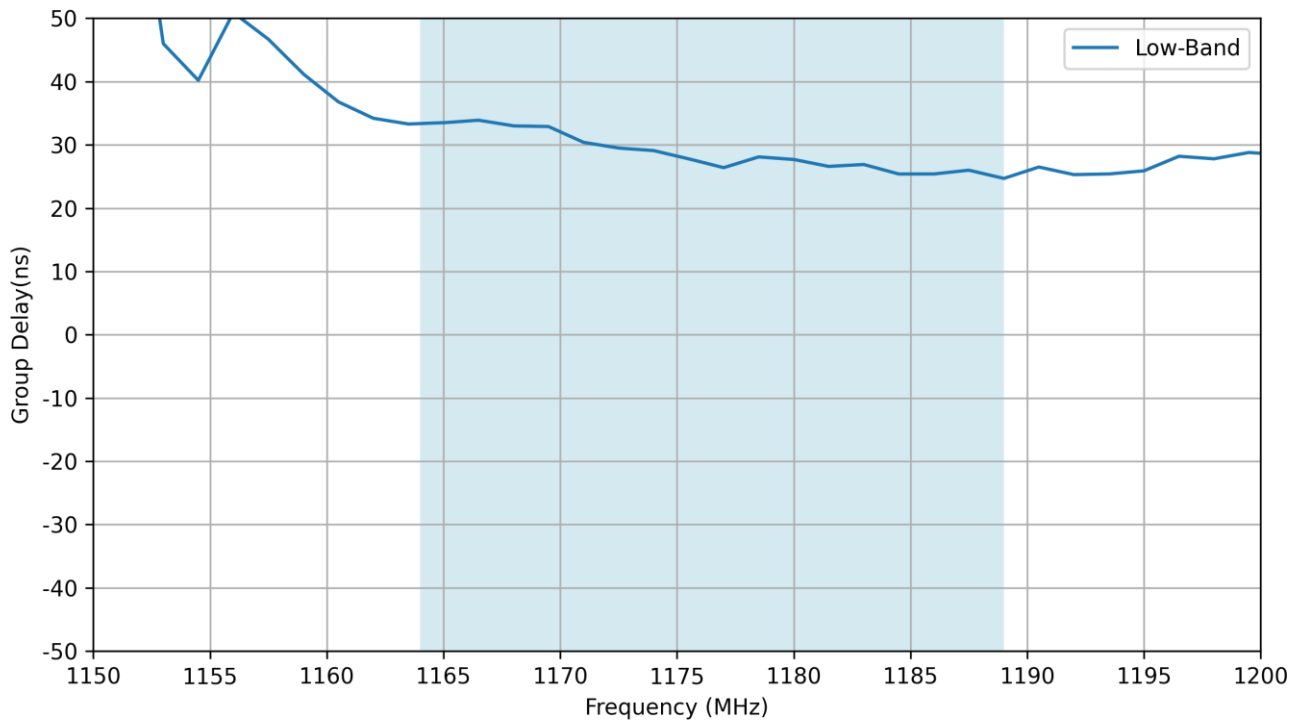

8. Radiation Patterns

8.1 Test Setup

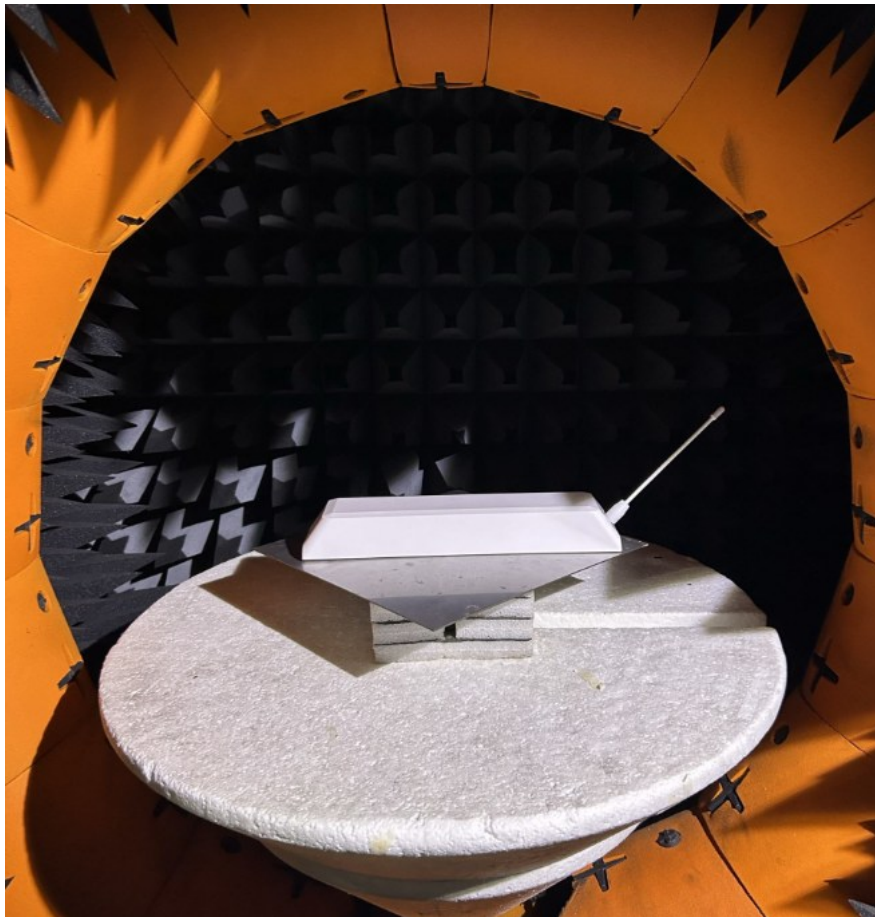
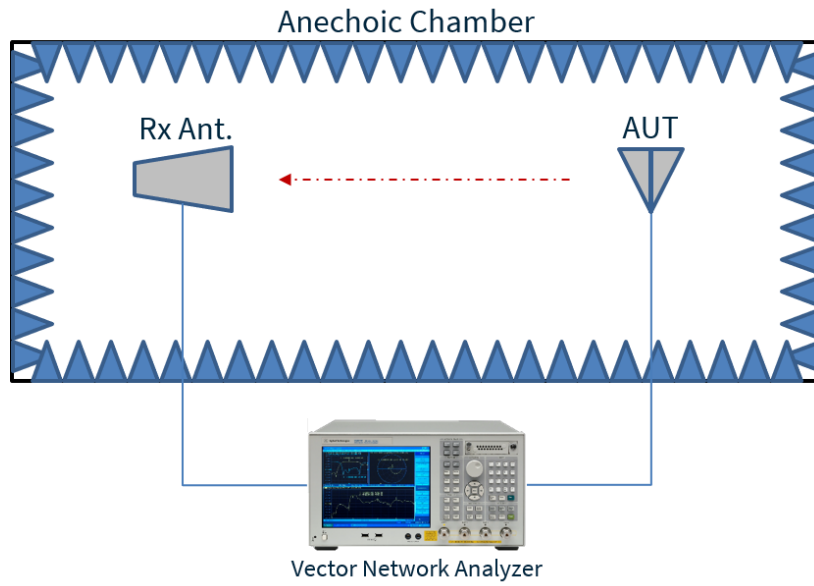

Chamber Test Set-up

8.2 GNSS Patterns at 1176 MHz

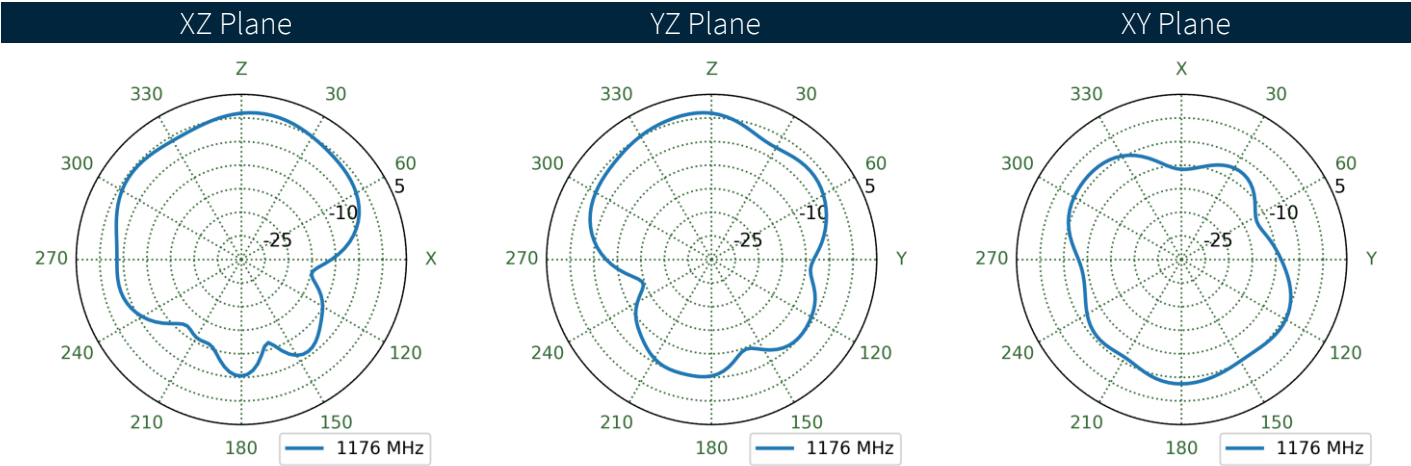
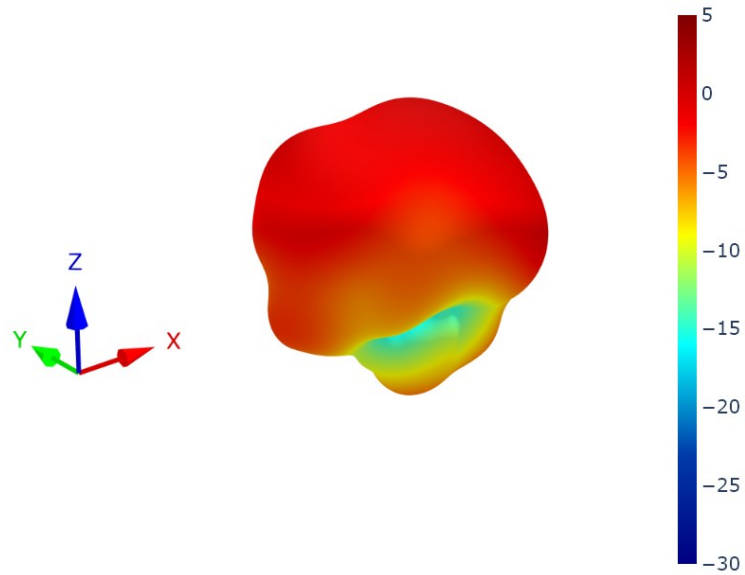

8.3 GNSS Patterns at 1575 MHz

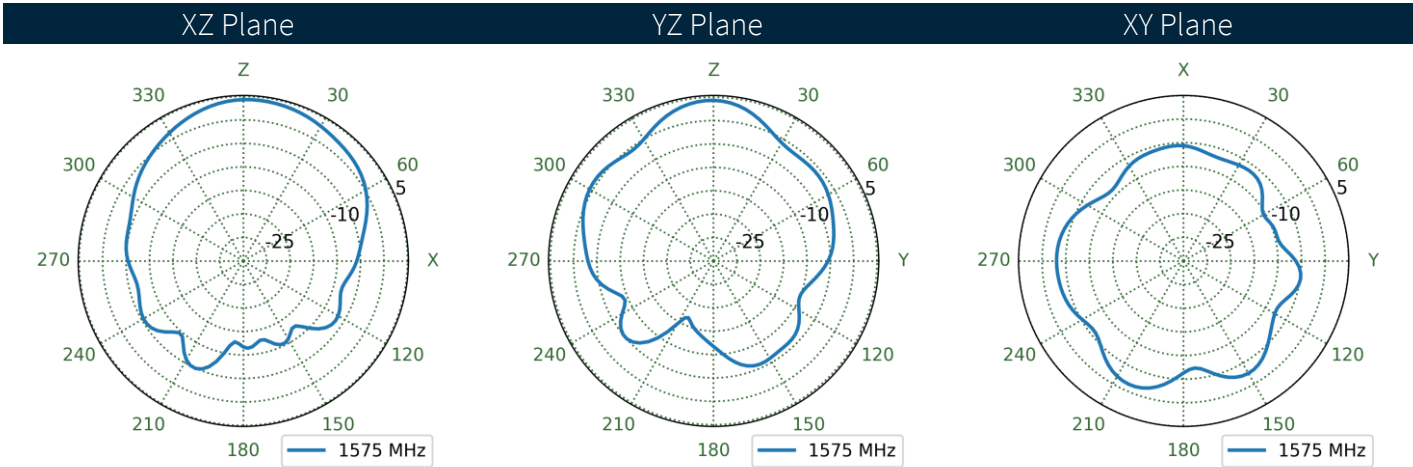
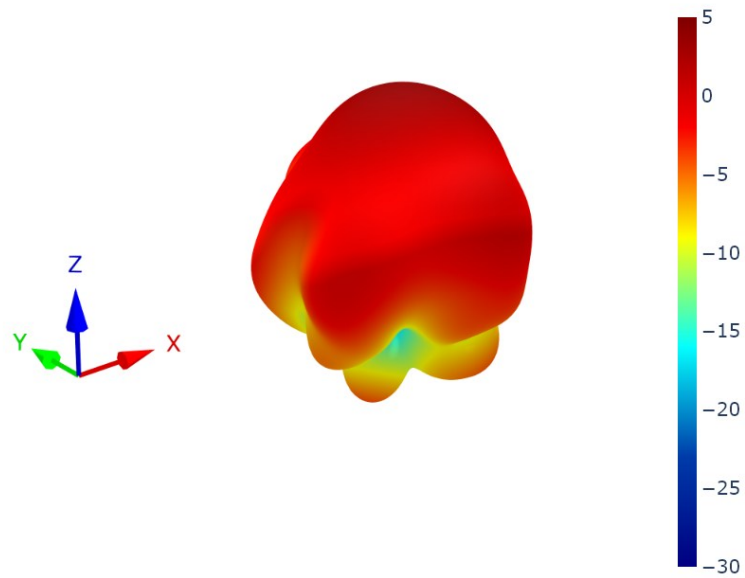

8.4 Cellular 1 Patterns at 652 MHz

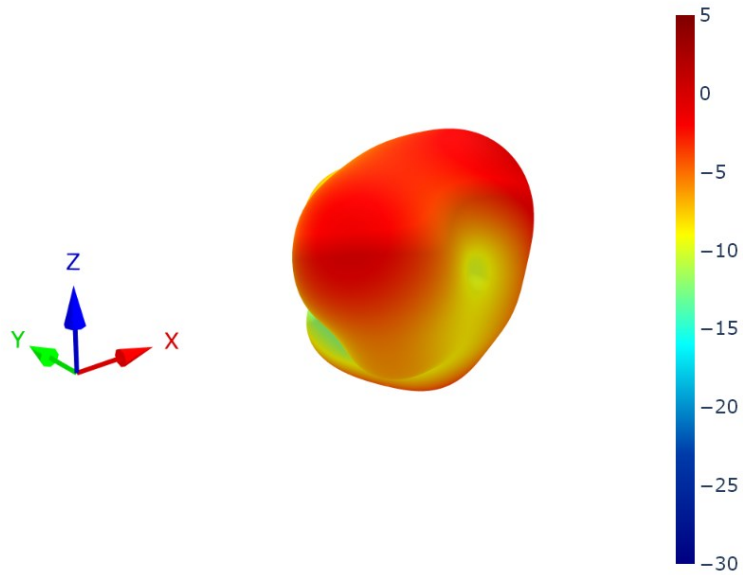

XZ Plane YZ Plane XY Plane

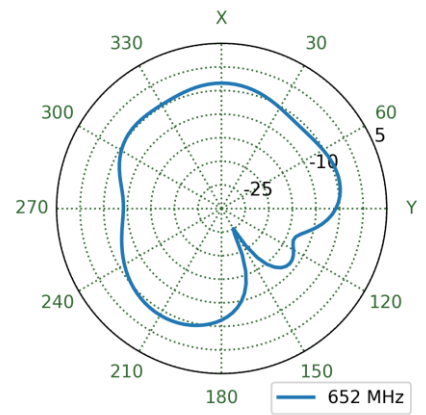
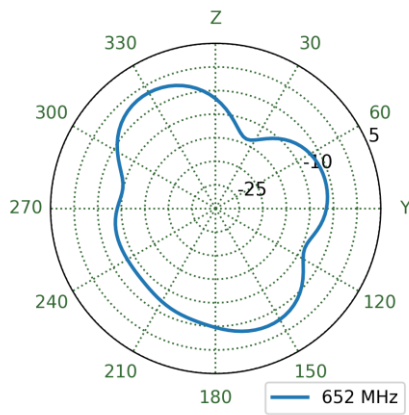
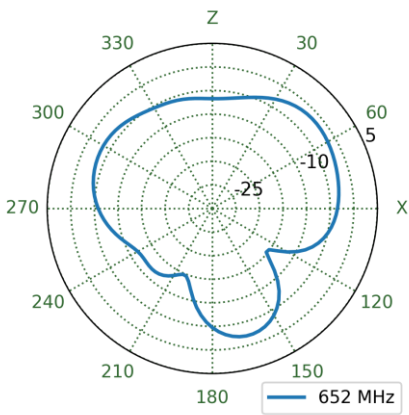

8.5 Cellular 2 Patterns at 652 MHz

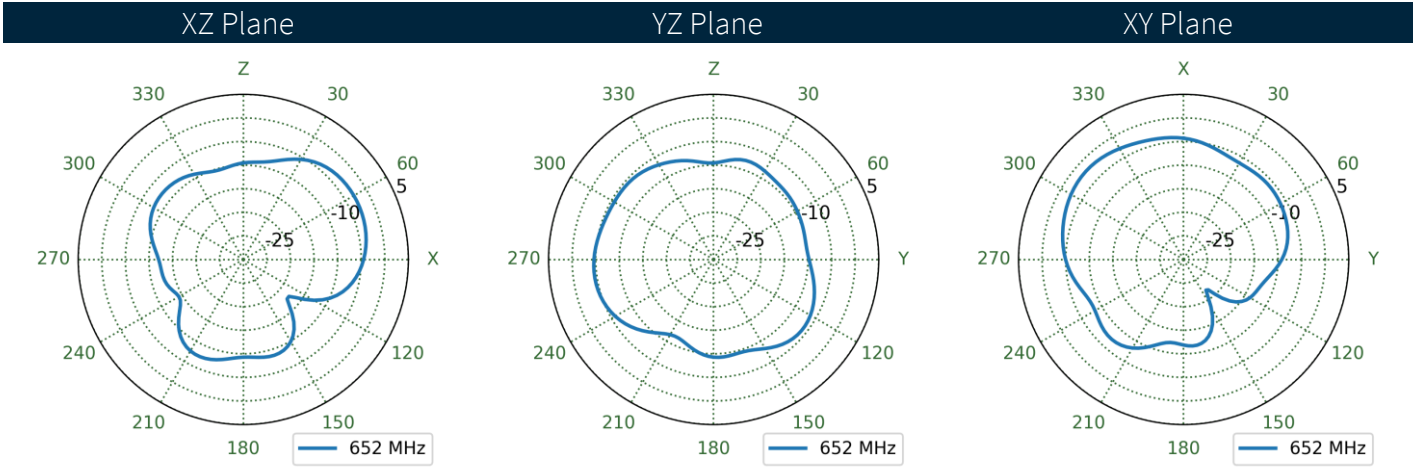
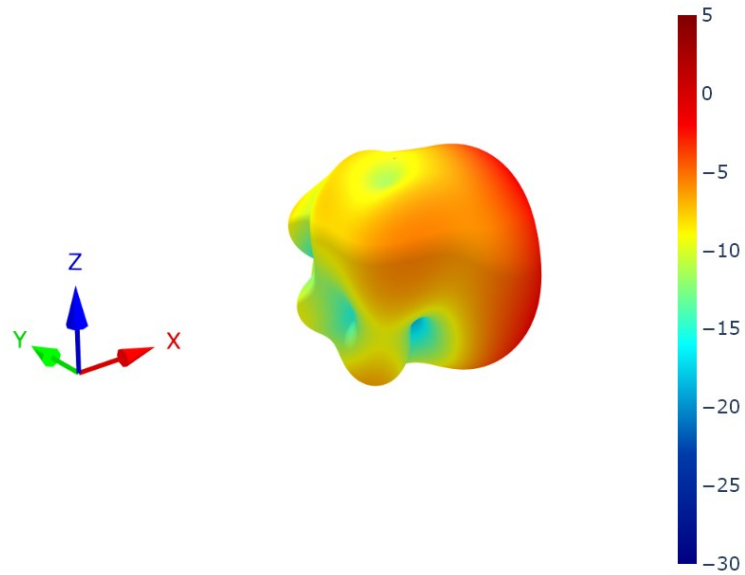

8.6 Cellular 3 Patterns at 652 MHz

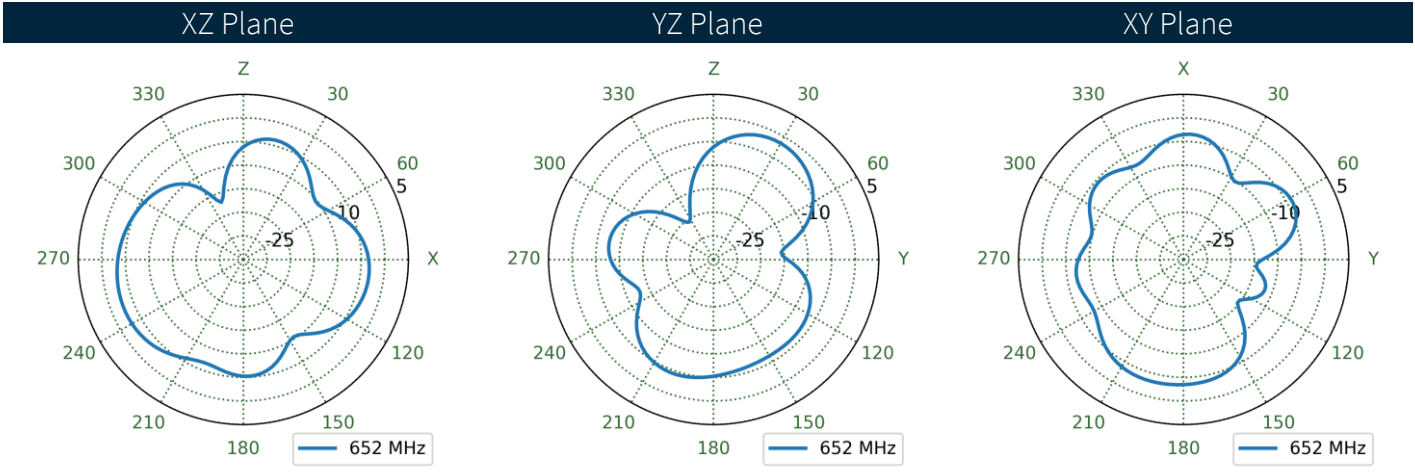
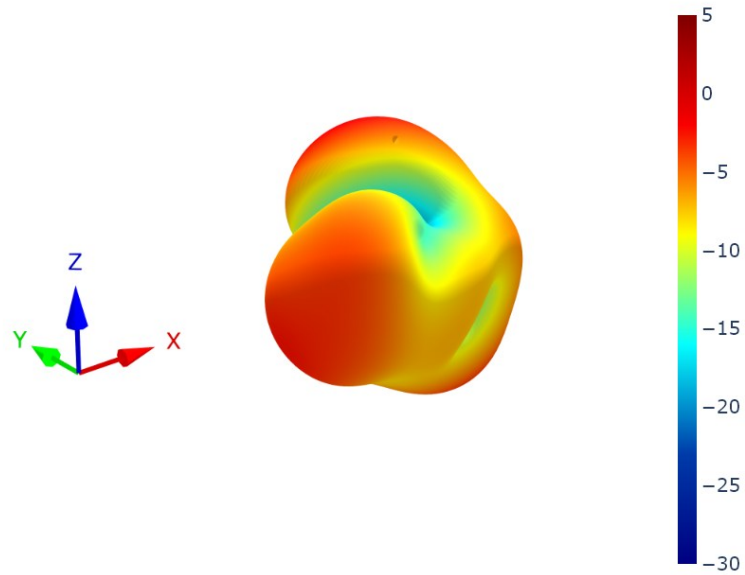

8.7 Cellular 4 Patterns at 652 MHz

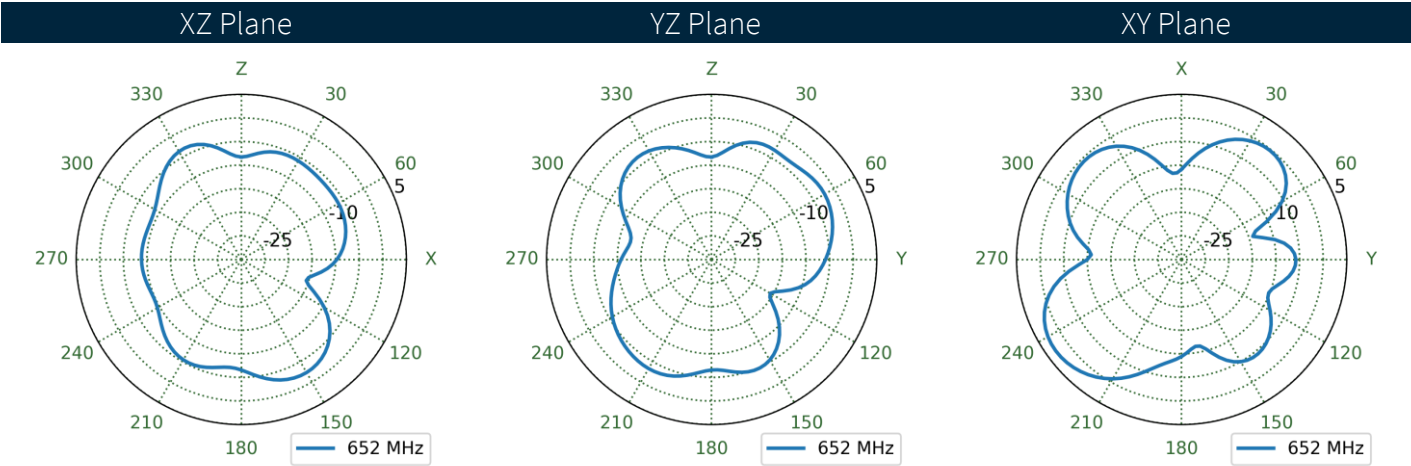
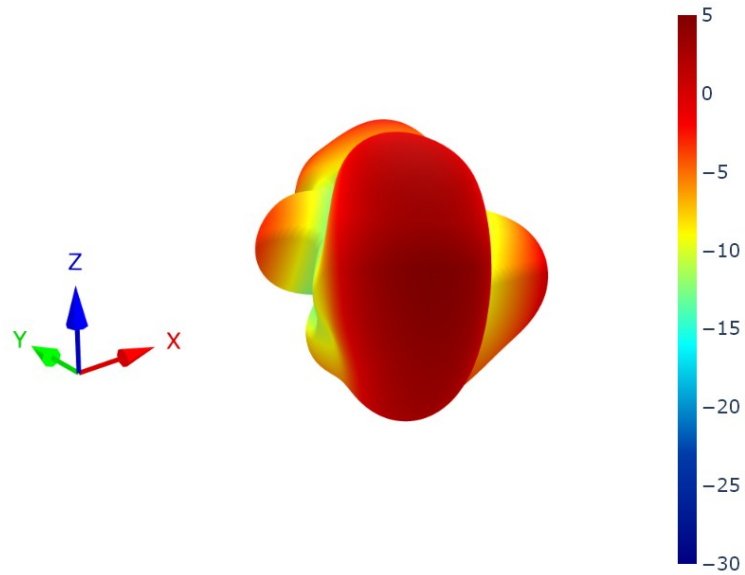

8.8 Cellular 5 Patterns at 652 MHz

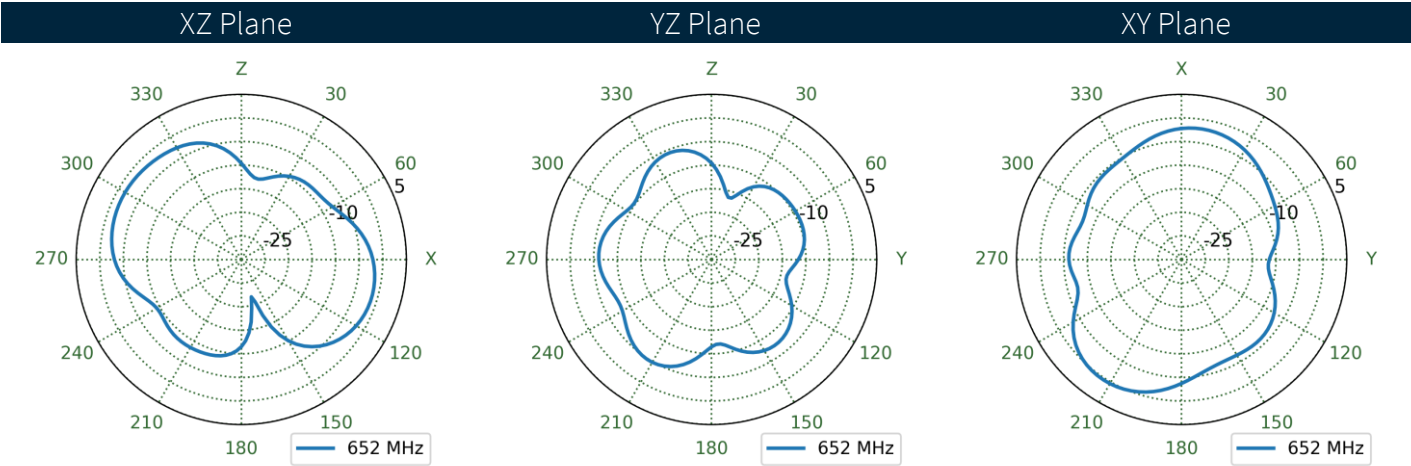
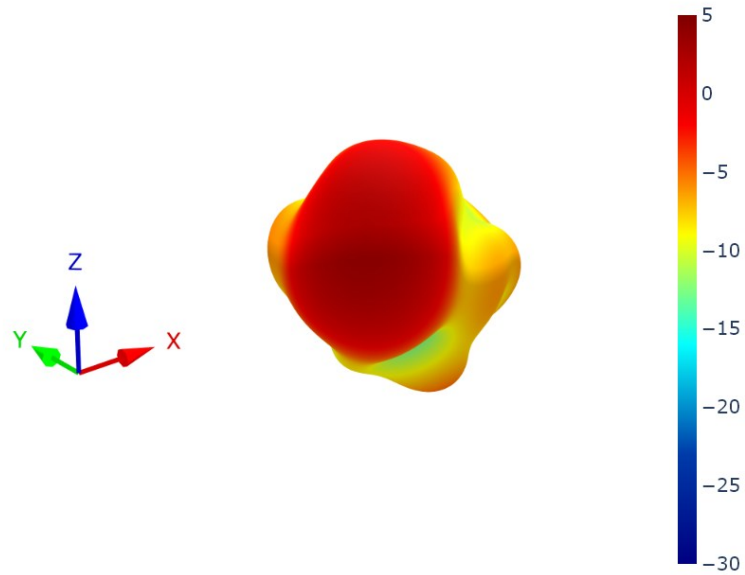

8.9 Cellular 6 Patterns at 652 MHz

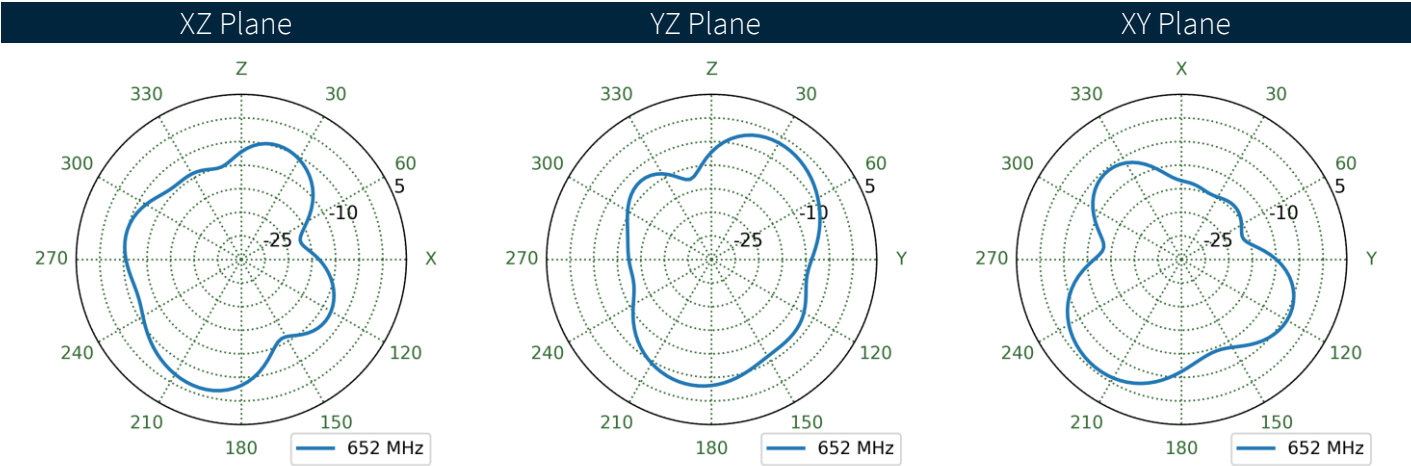
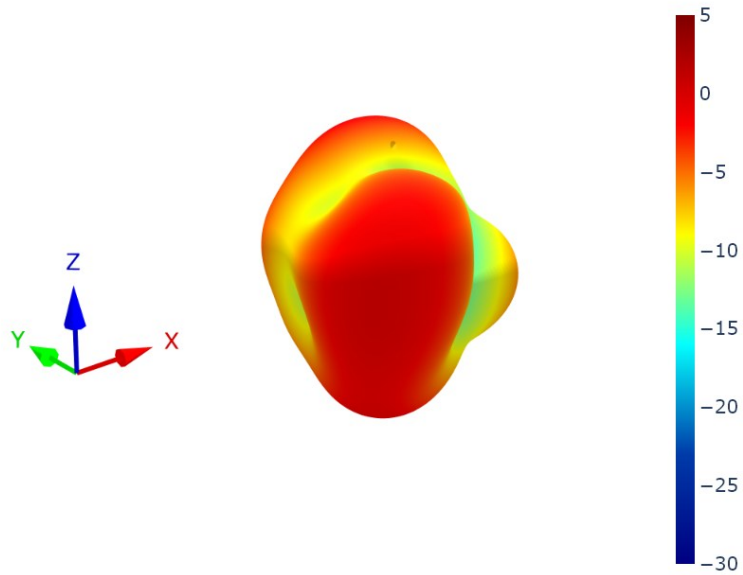

8.10 Cellular 7 Patterns at 652 MHz

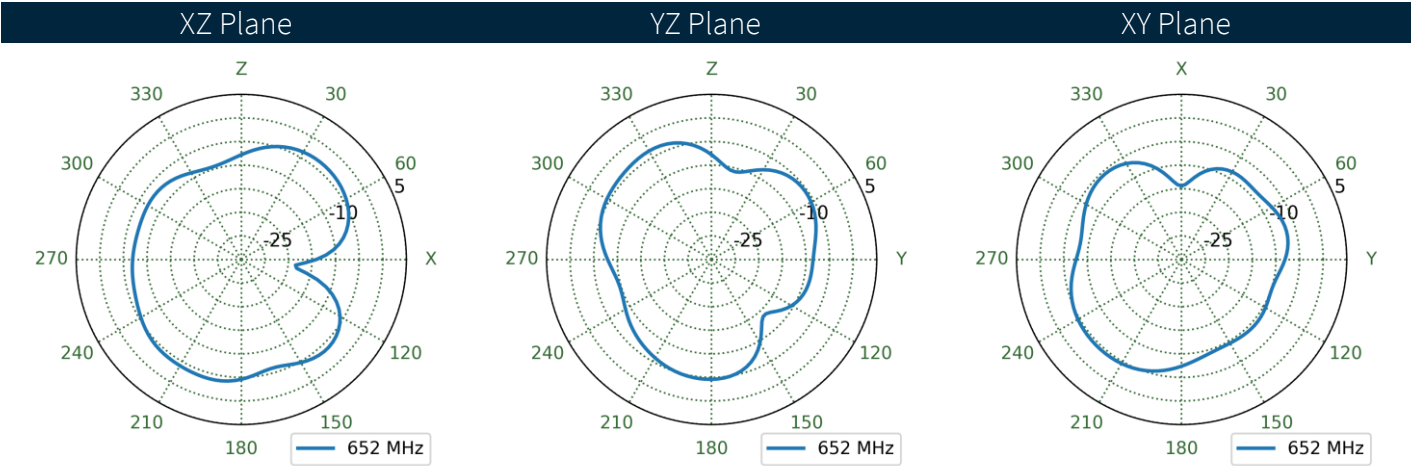
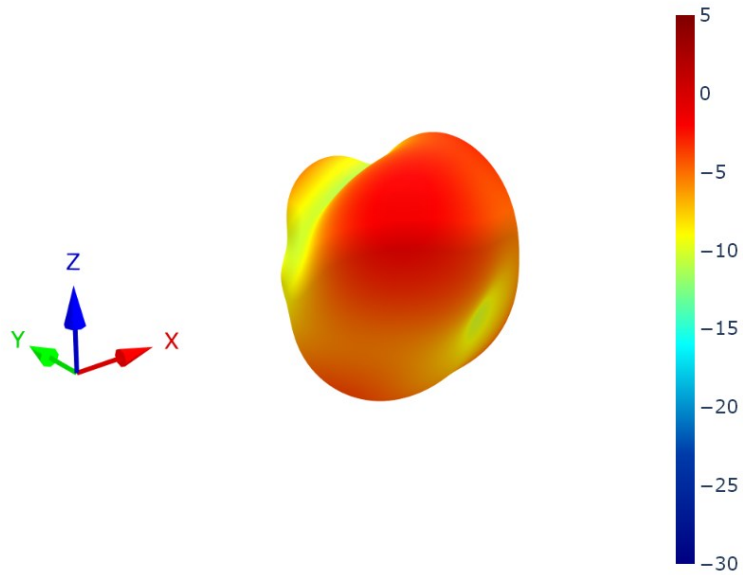

8.11 Cellular 8 Patterns at 652 MHz

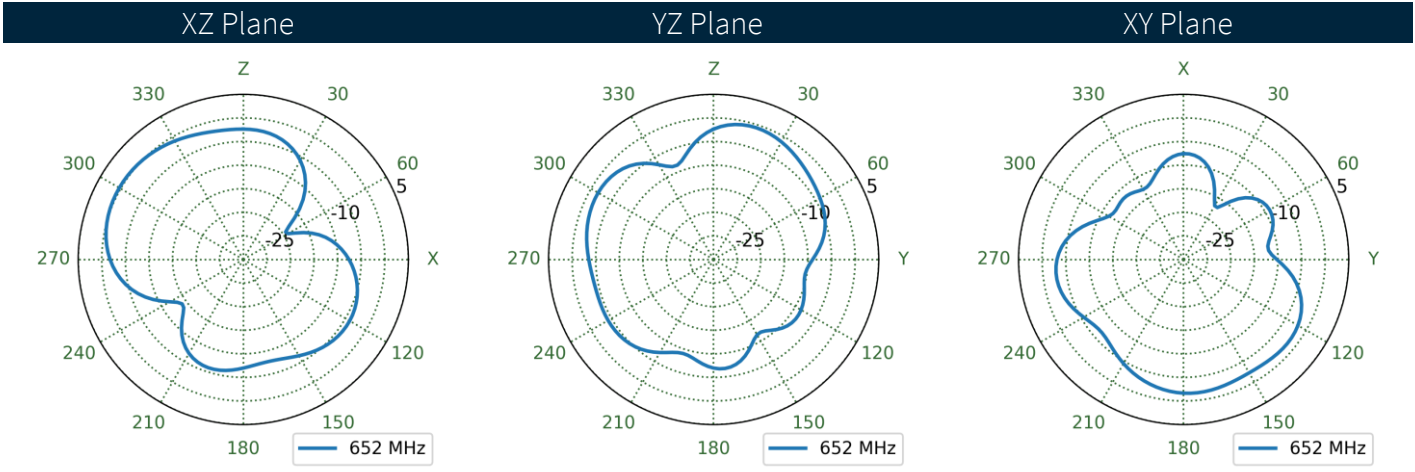
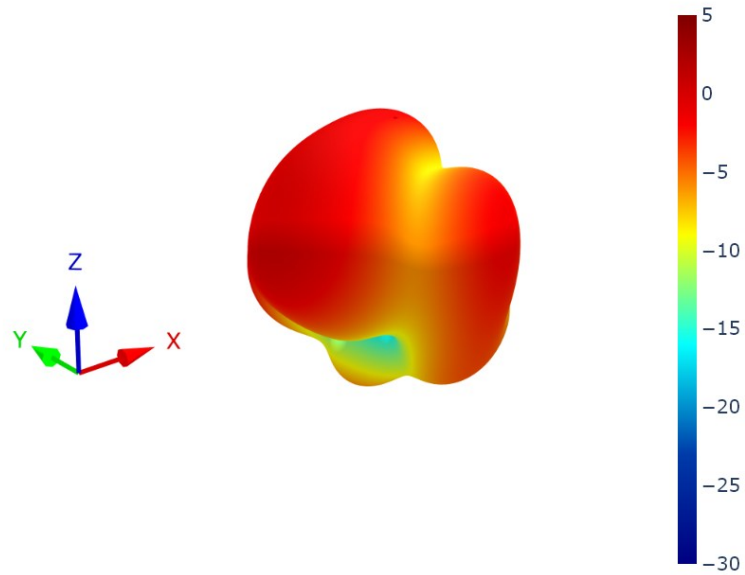

8.12 Cellular 1 Patterns at 751 MHz

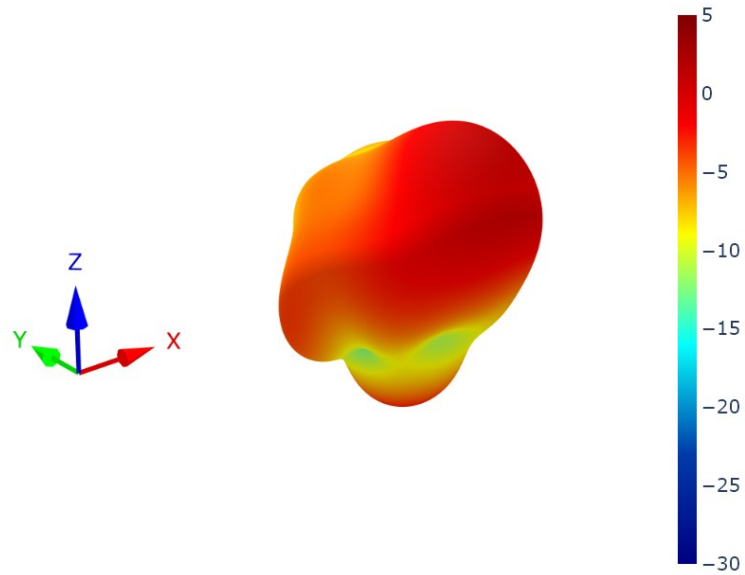

XZ Plane YZ Plane XY Plane

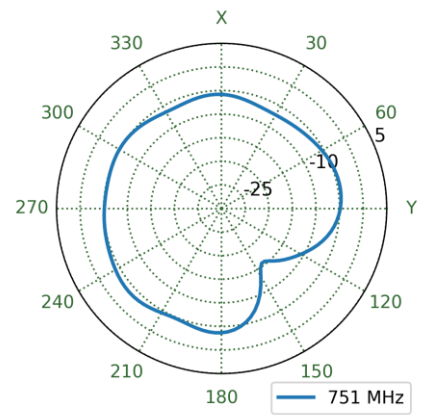
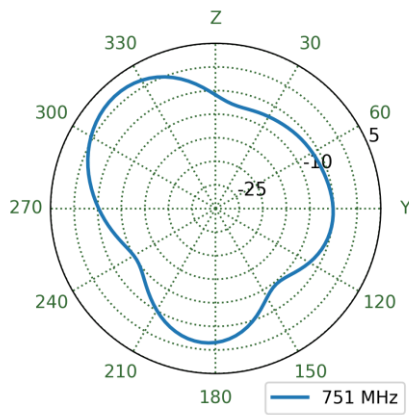
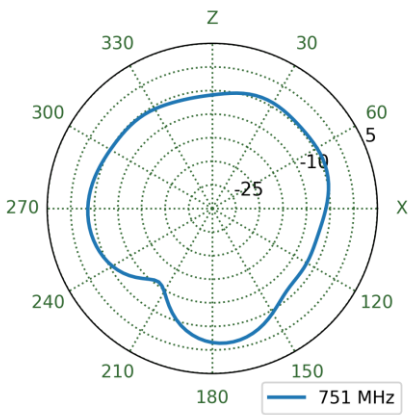

8.13 Cellular 2 Patterns at 751 MHz

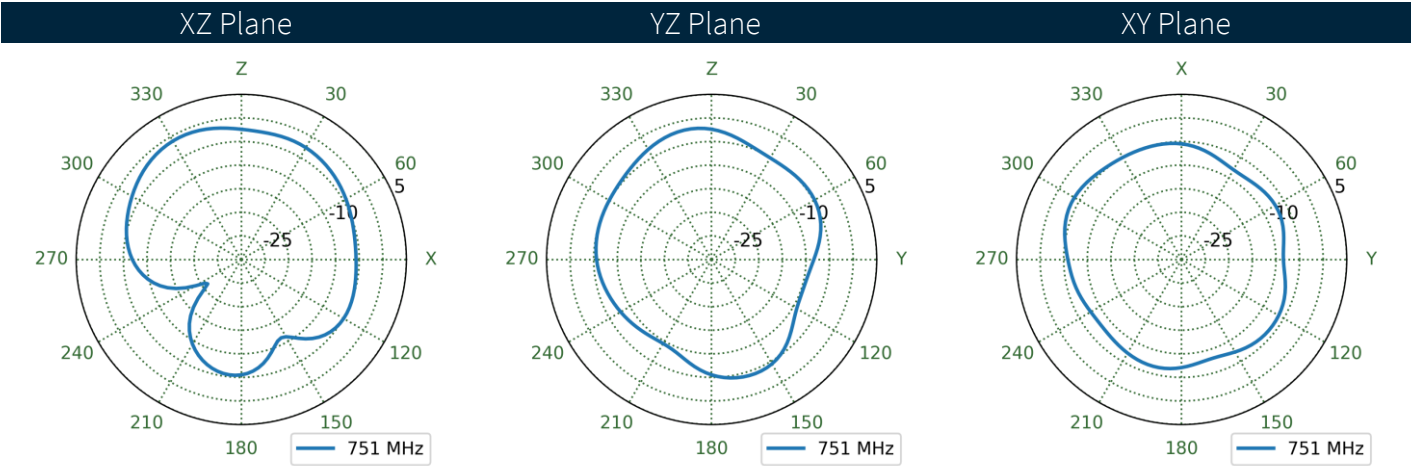
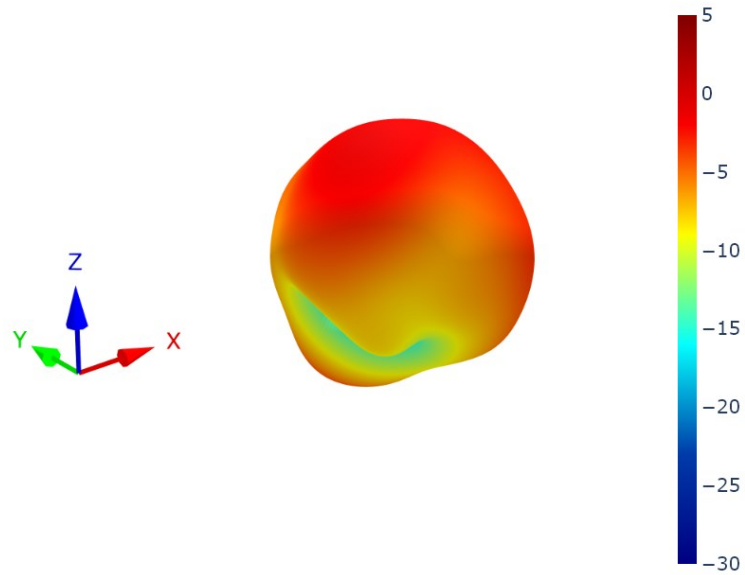

8.14 Cellular 3 Patterns at 751 MHz

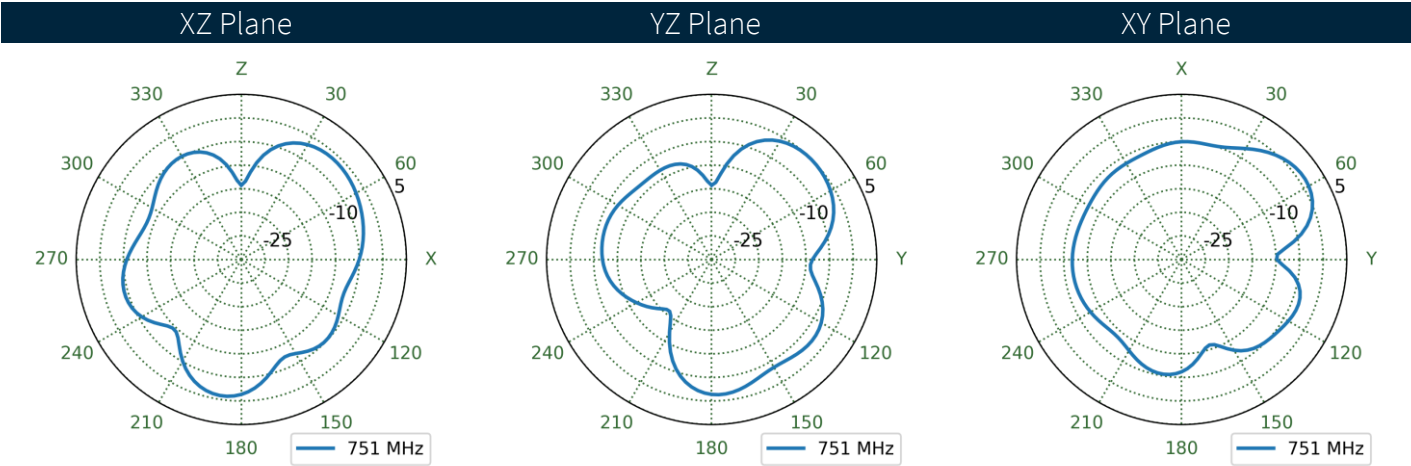
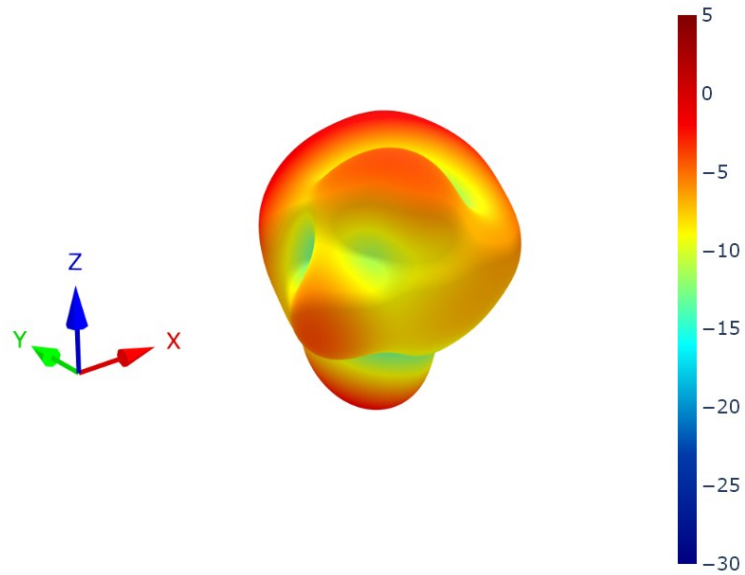

8.15 Cellular 4 Patterns at 751 MHz

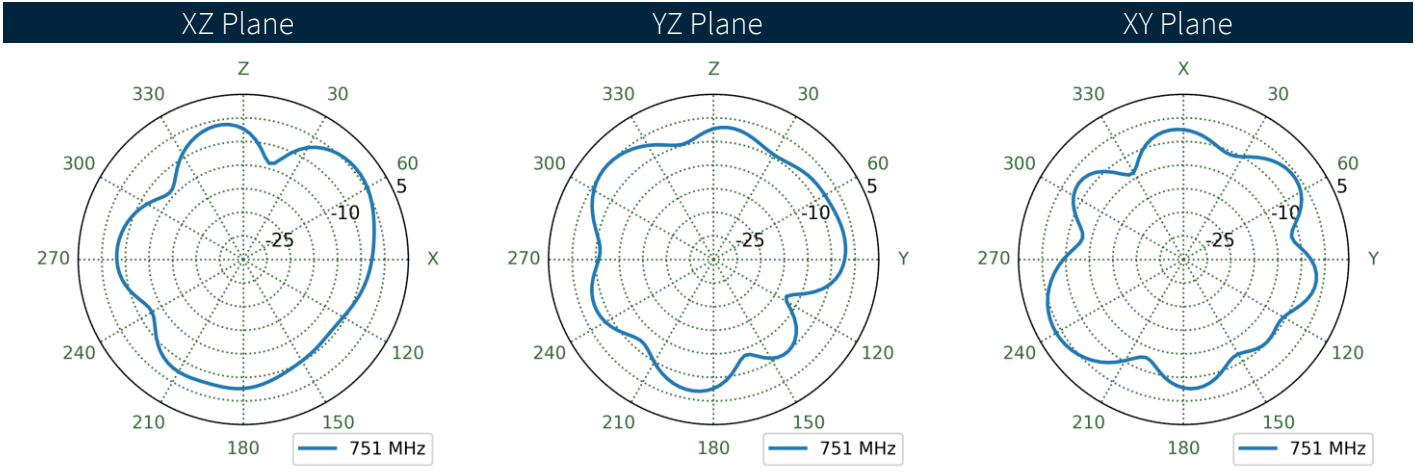
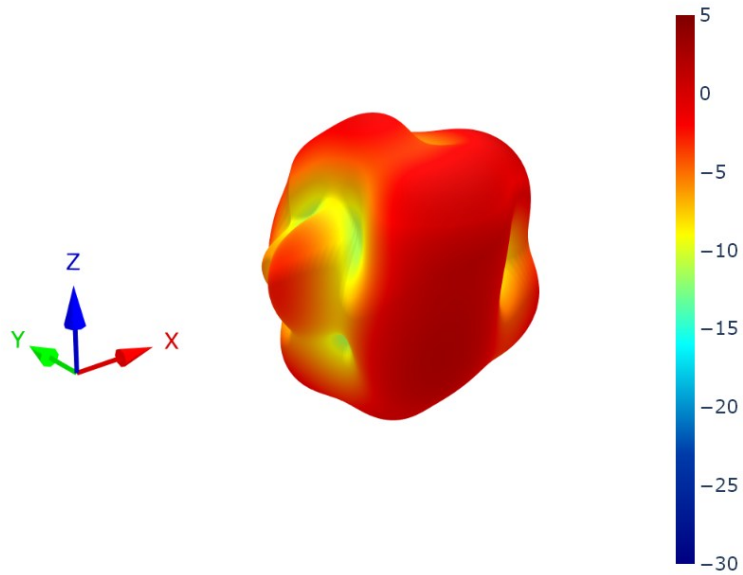

8.16 Cellular 5 Patterns at 751 MHz

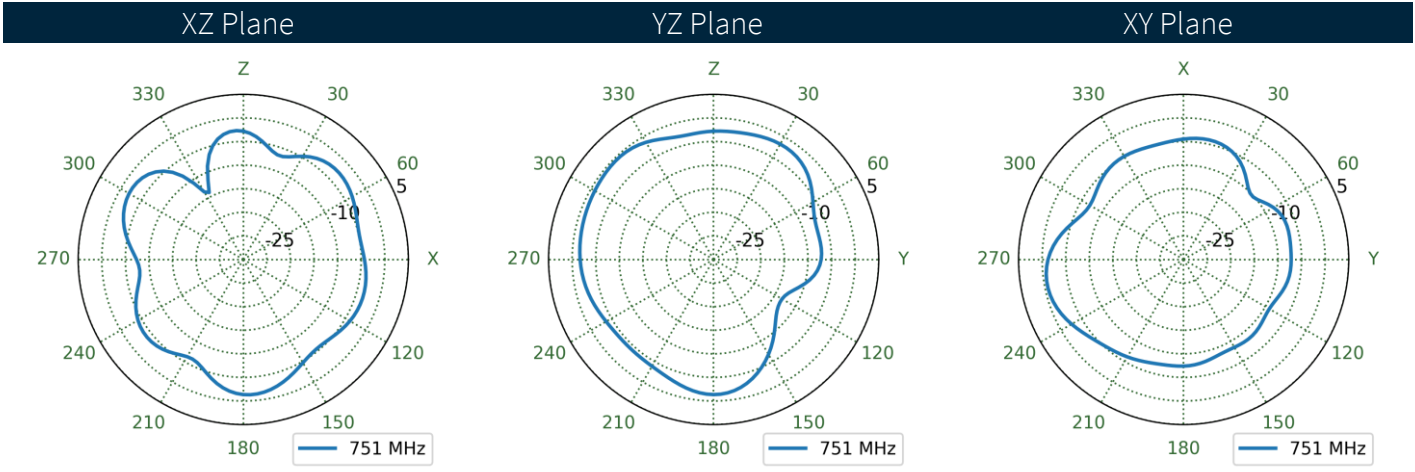
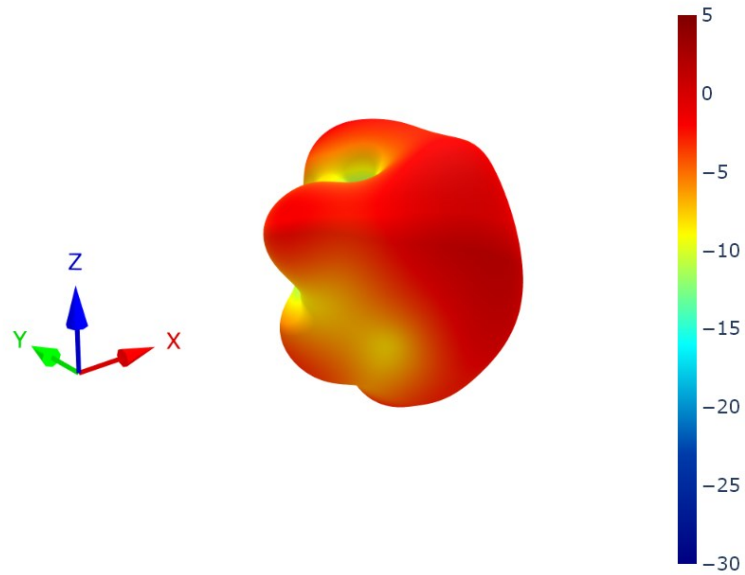

8.17 Cellular 6 Patterns at 751 MHz

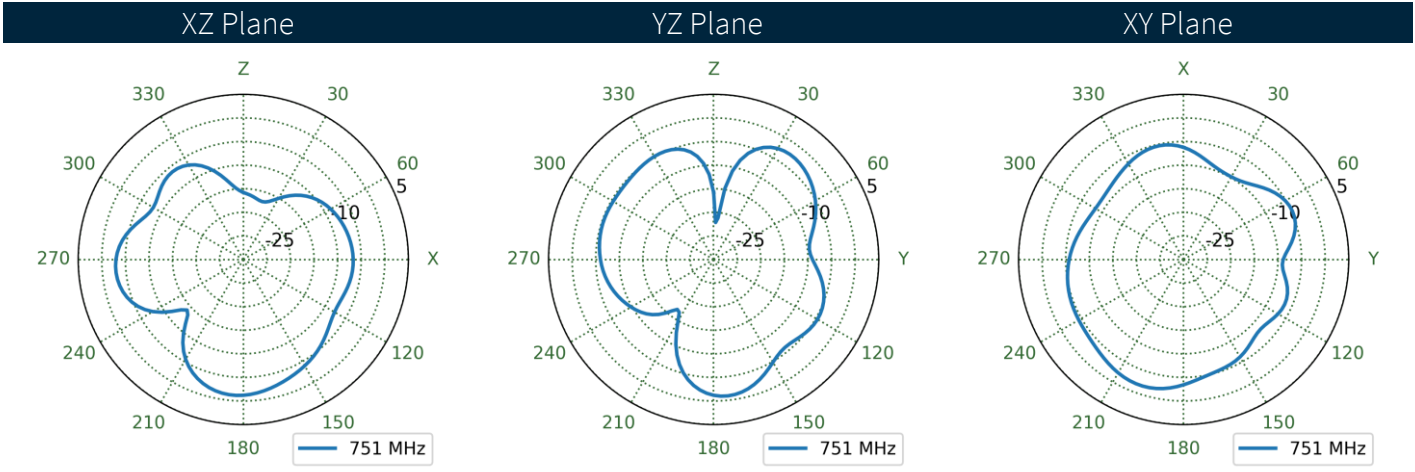
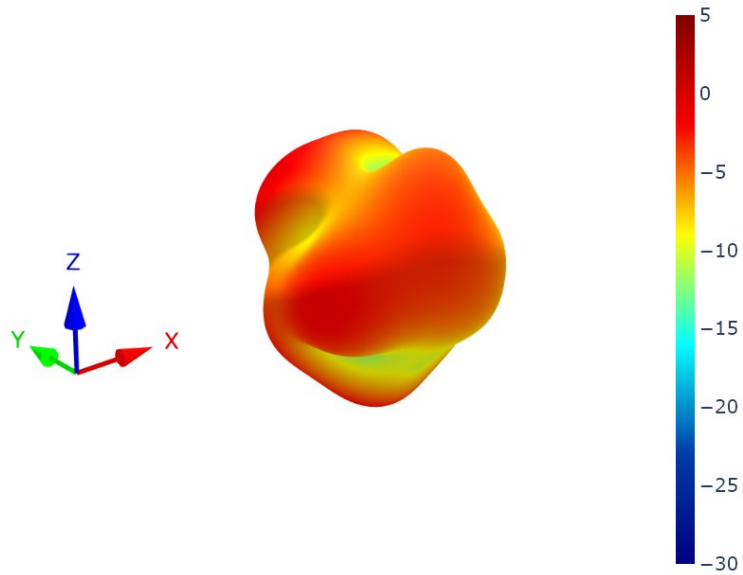

8.18 Cellular 7 Patterns at 751 MHz

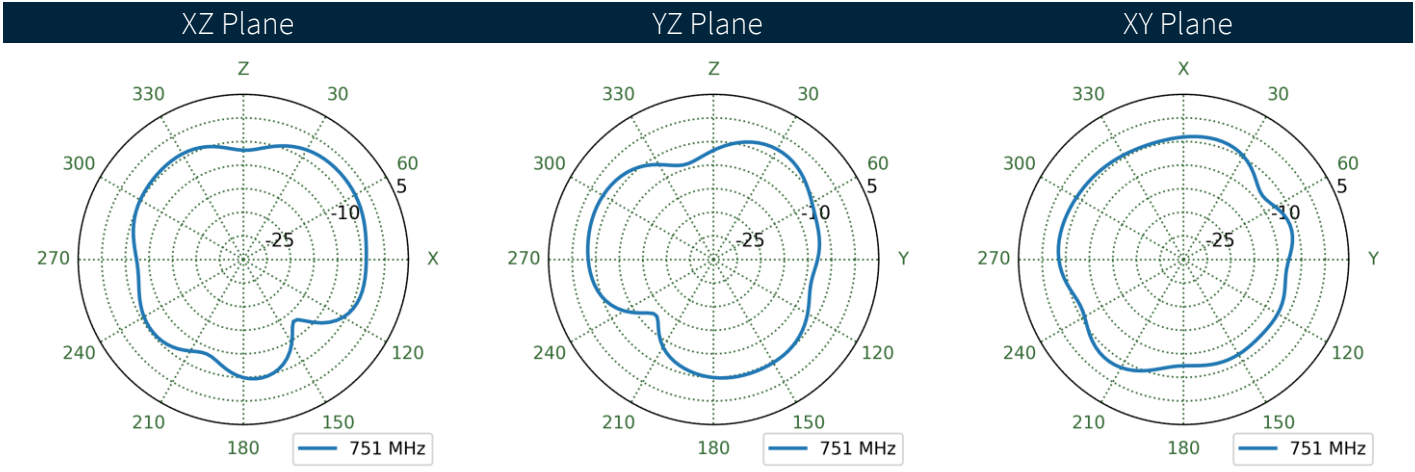
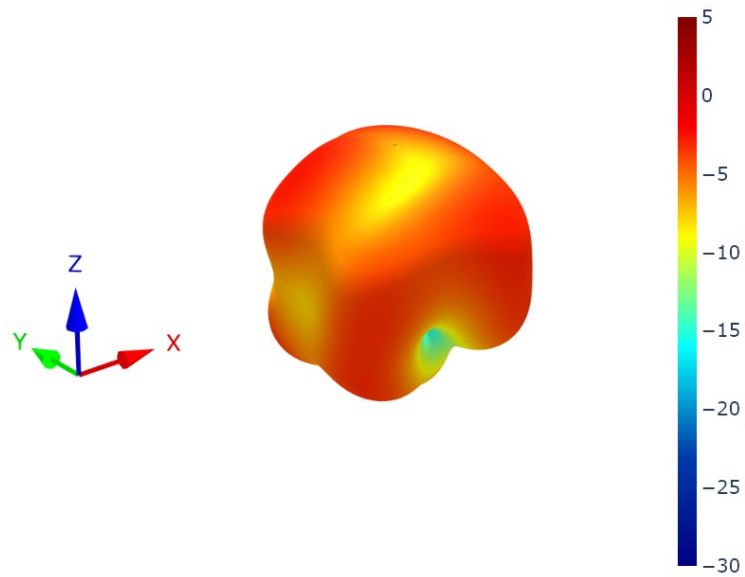

8.19 Cellular 8 Patterns at 751 MHz

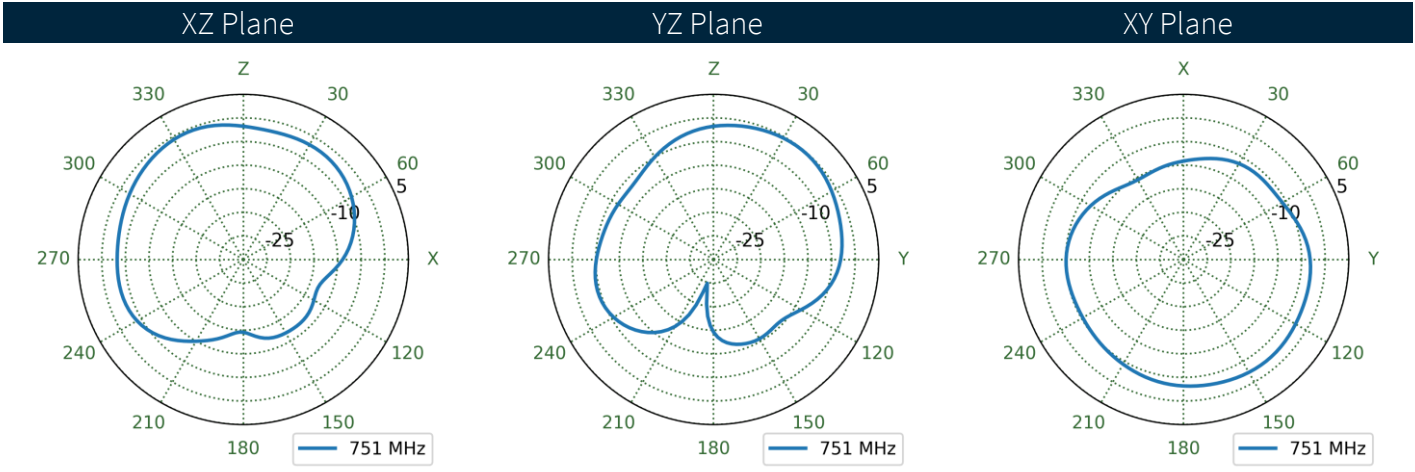
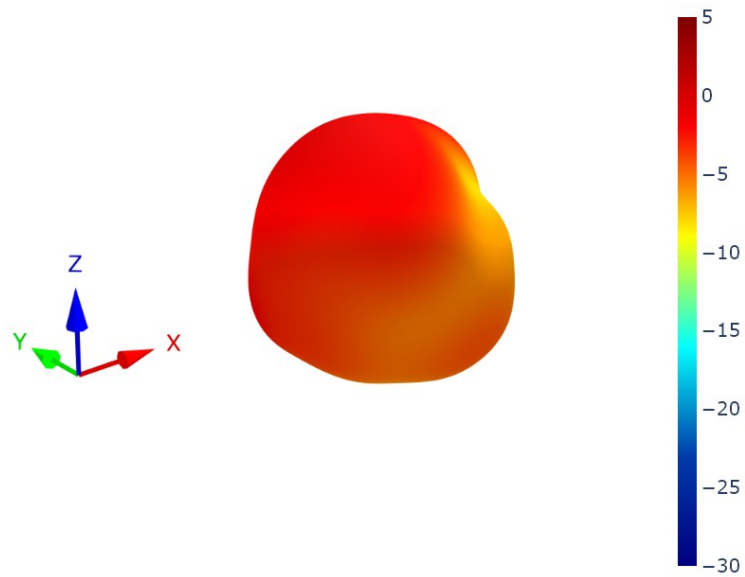

8.20 Cellular 1 Patterns at 890 MHz

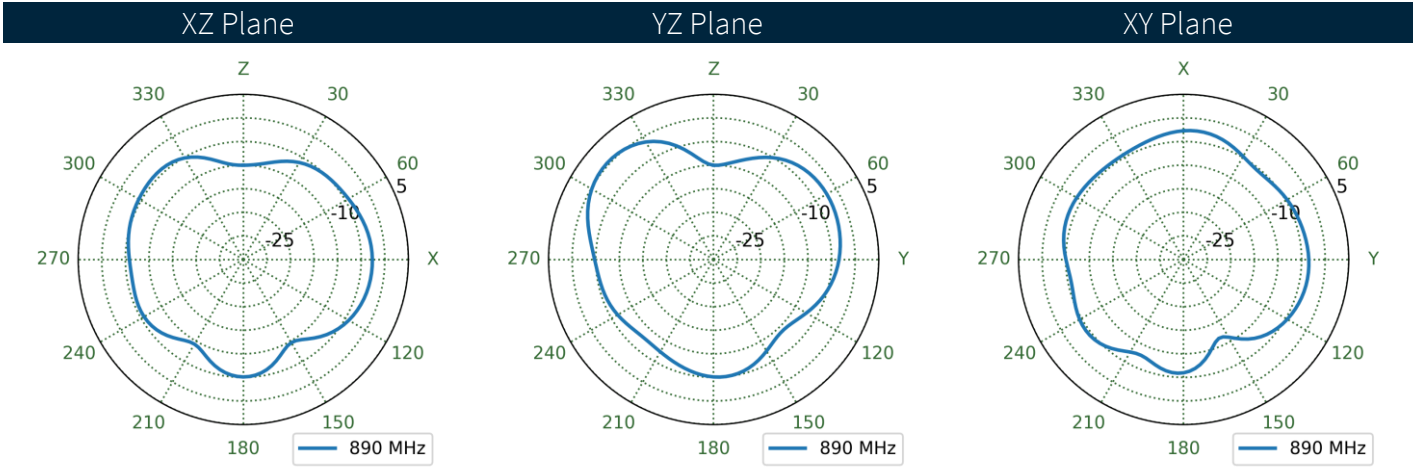
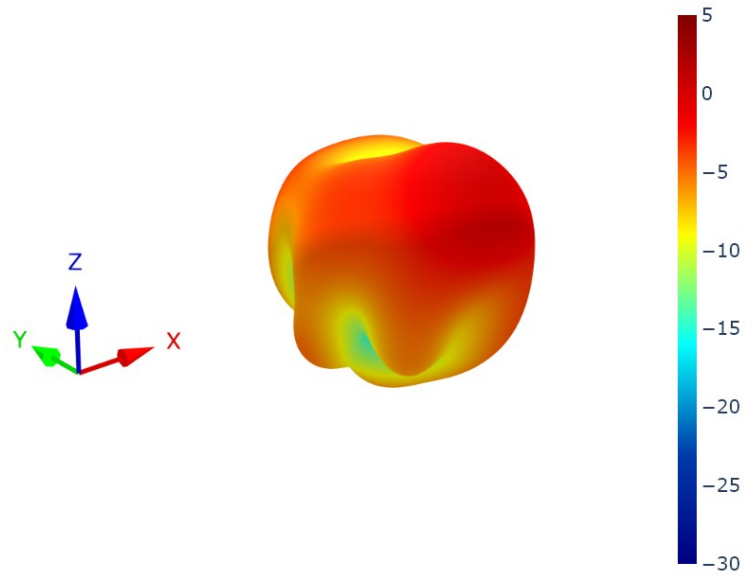

8.21 Cellular 2 Patterns at 890 MHz

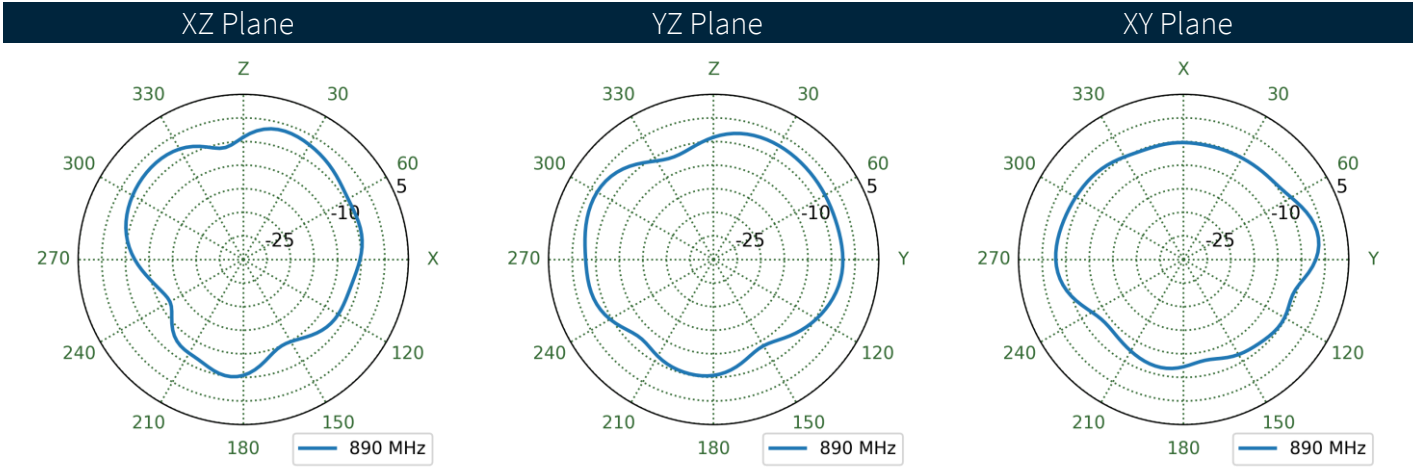
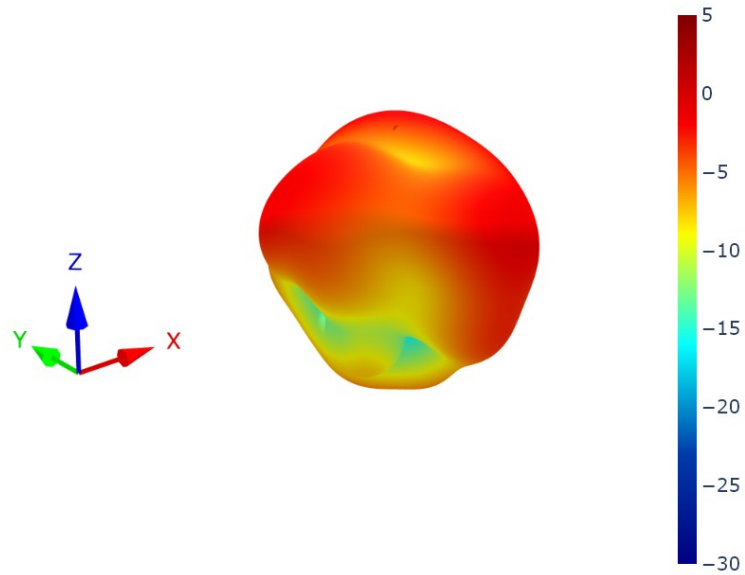

8.22 Cellular 3 Patterns at 890 MHz

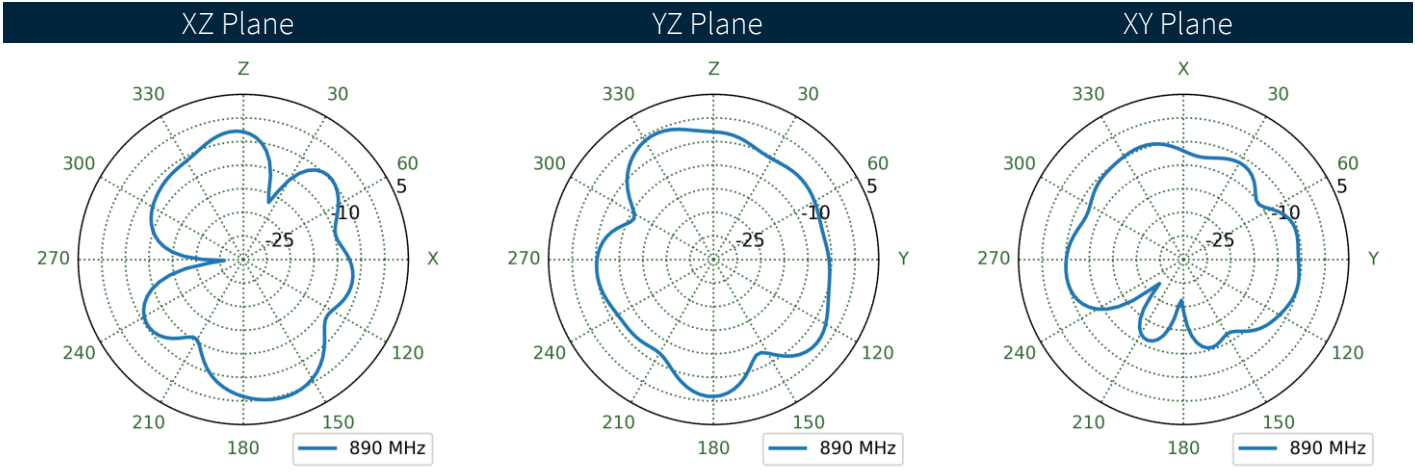
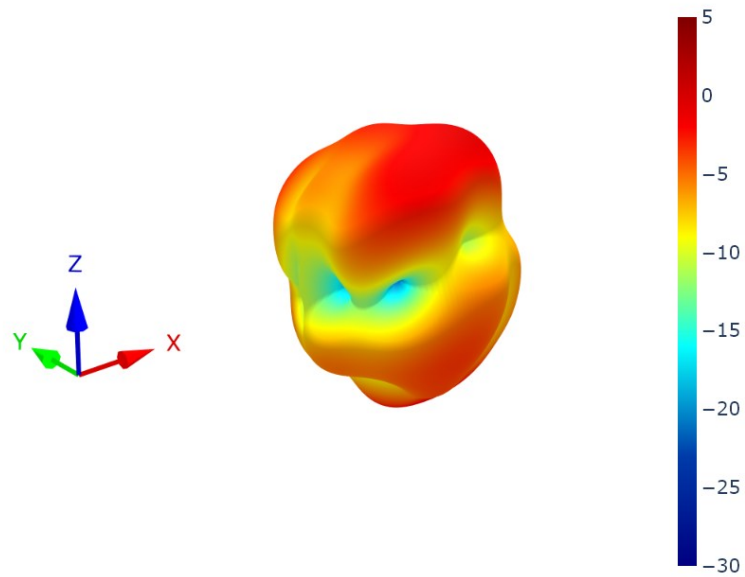

8.23 Cellular 4 Patterns at 890 MHz

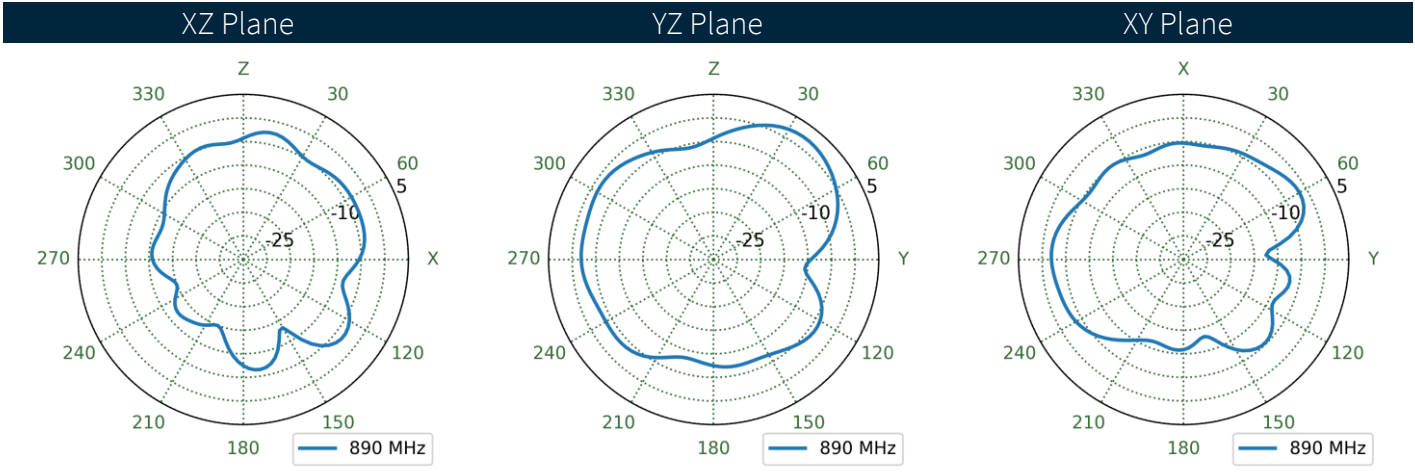
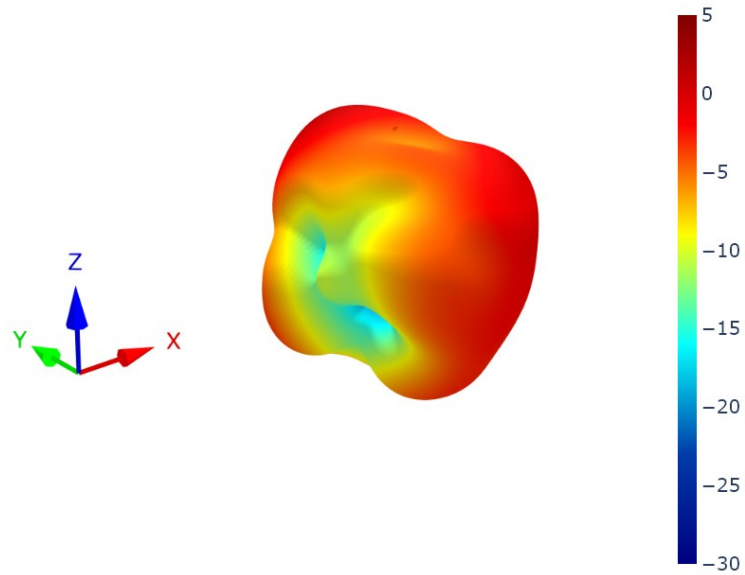

8.24 Cellular 5 Patterns at 890 MHz

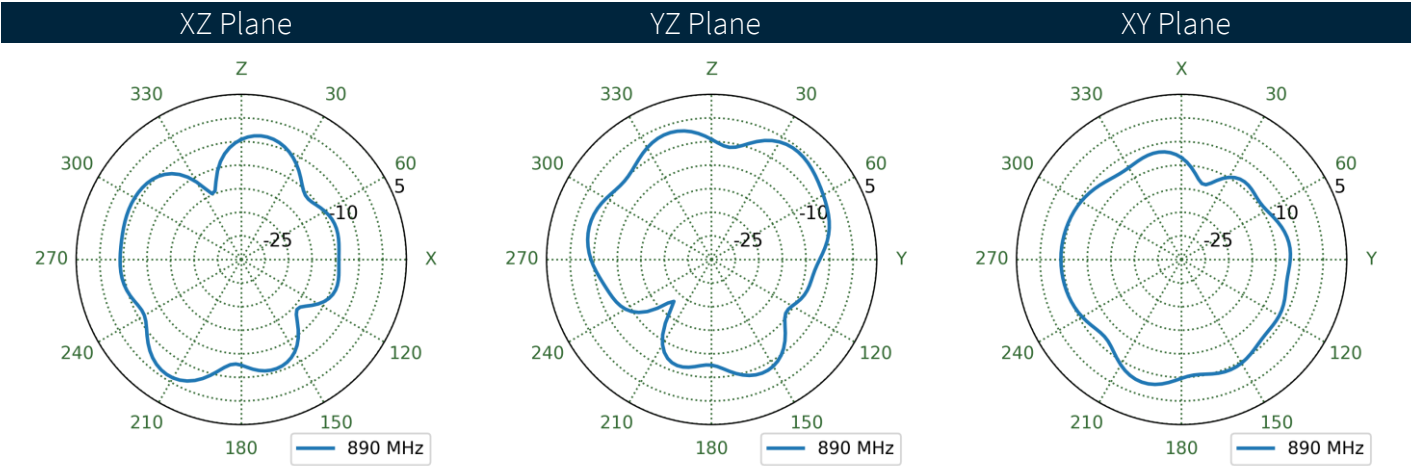
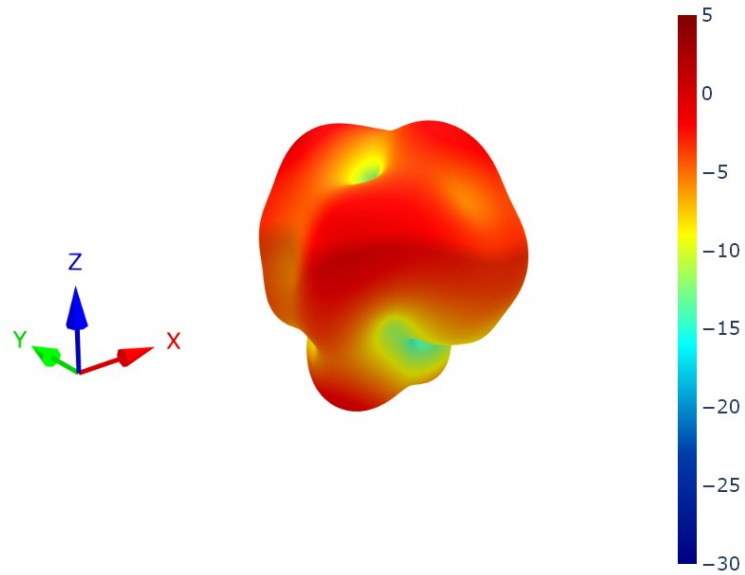

8.25 Cellular 6 Patterns at 890 MHz

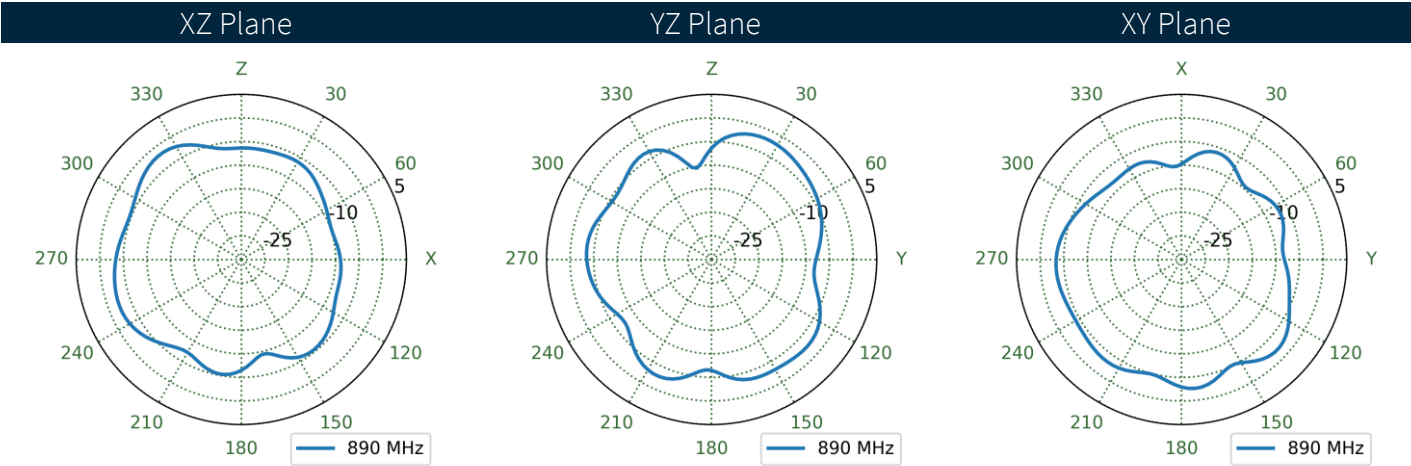
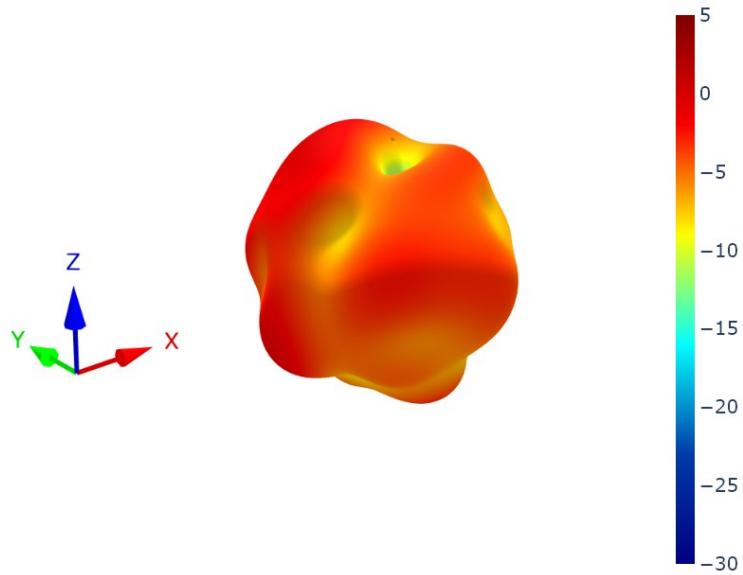

8.26 Cellular 7 Patterns at 890 MHz

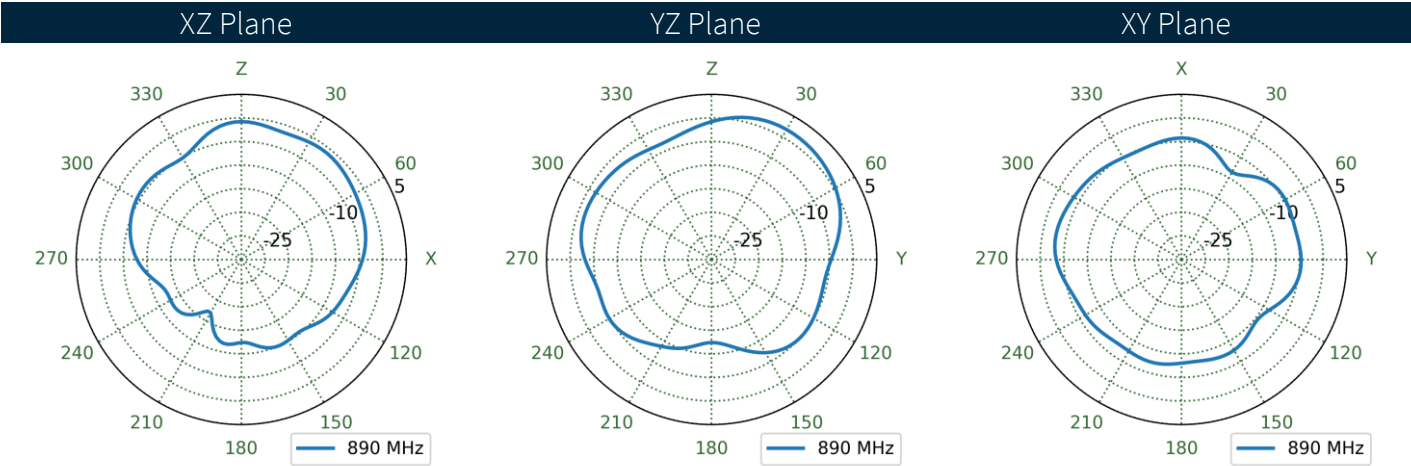
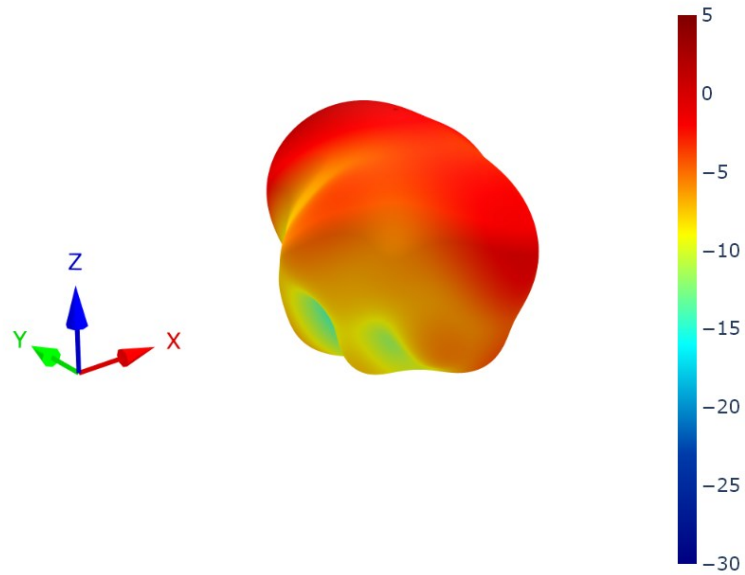

8.27 Cellular 8 Patterns at 890 MHz

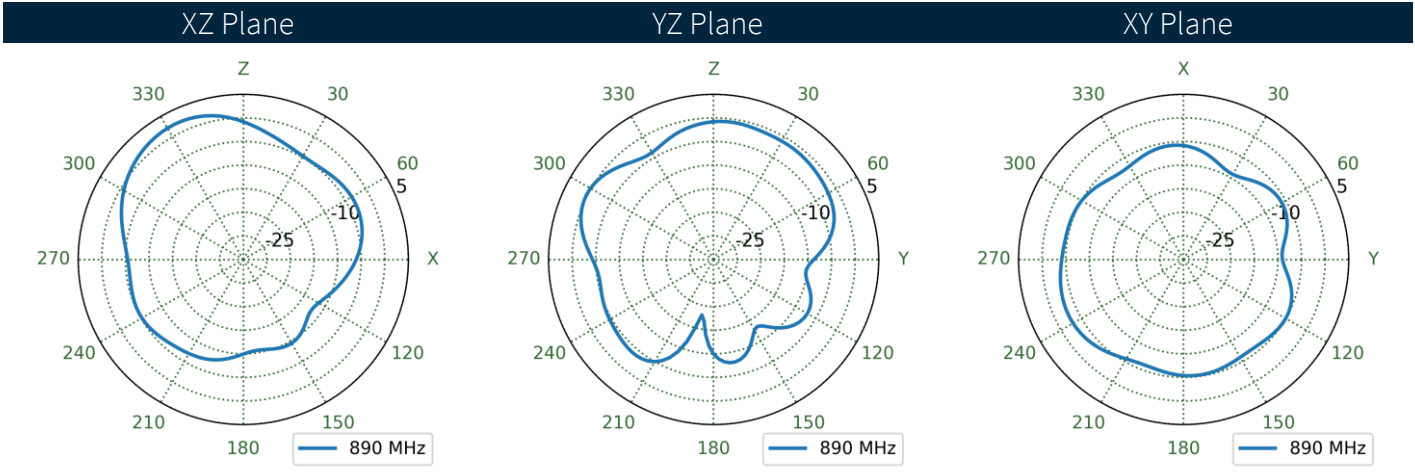
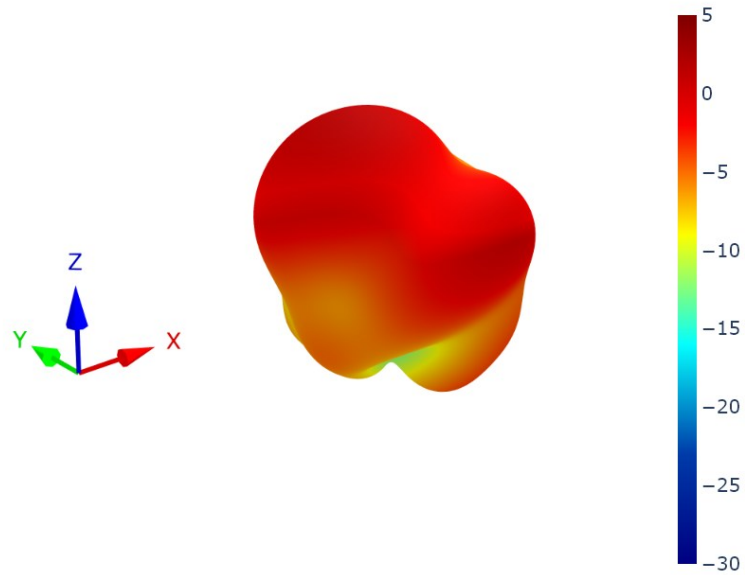

8.28 Cellular 1 Patterns at 1470 MHz

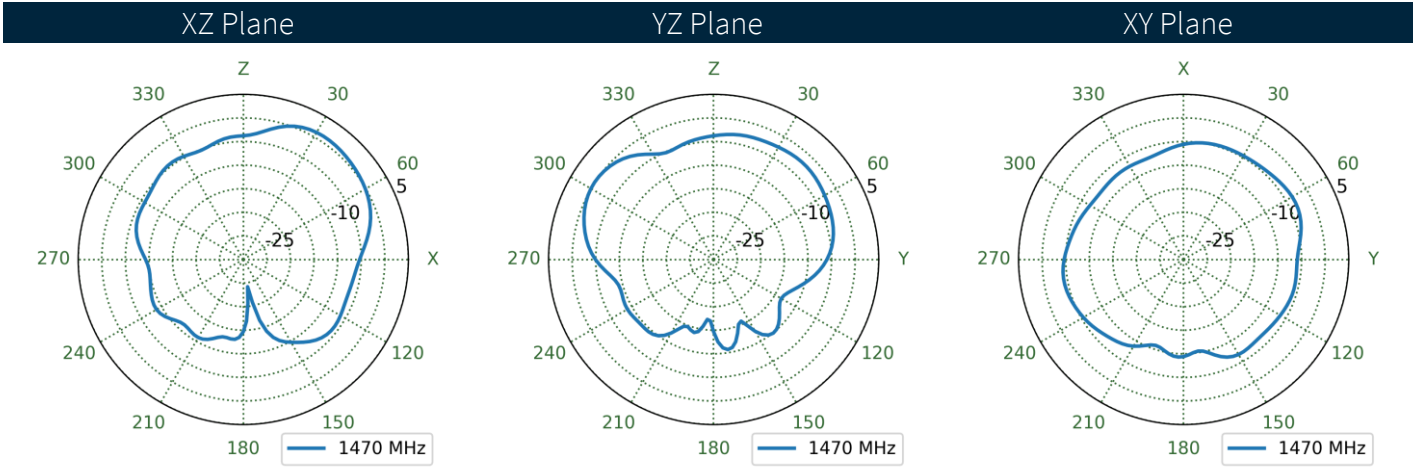
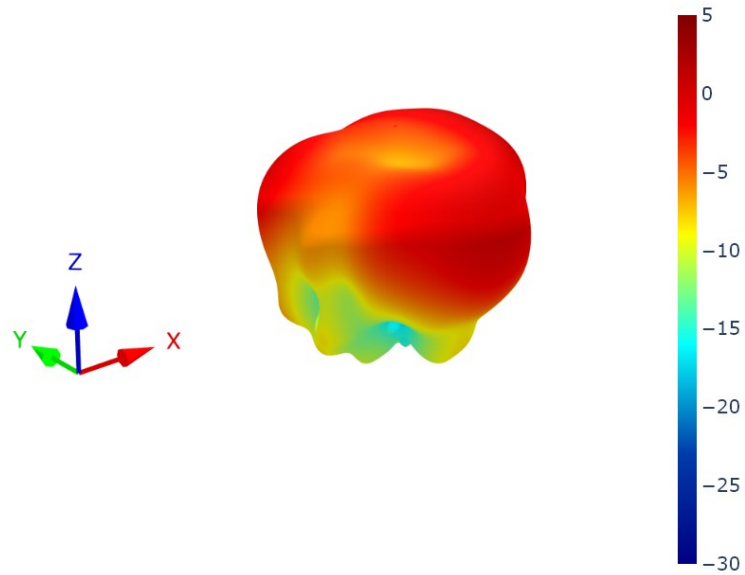

8.29 Cellular 2 Patterns at 1470 MHz

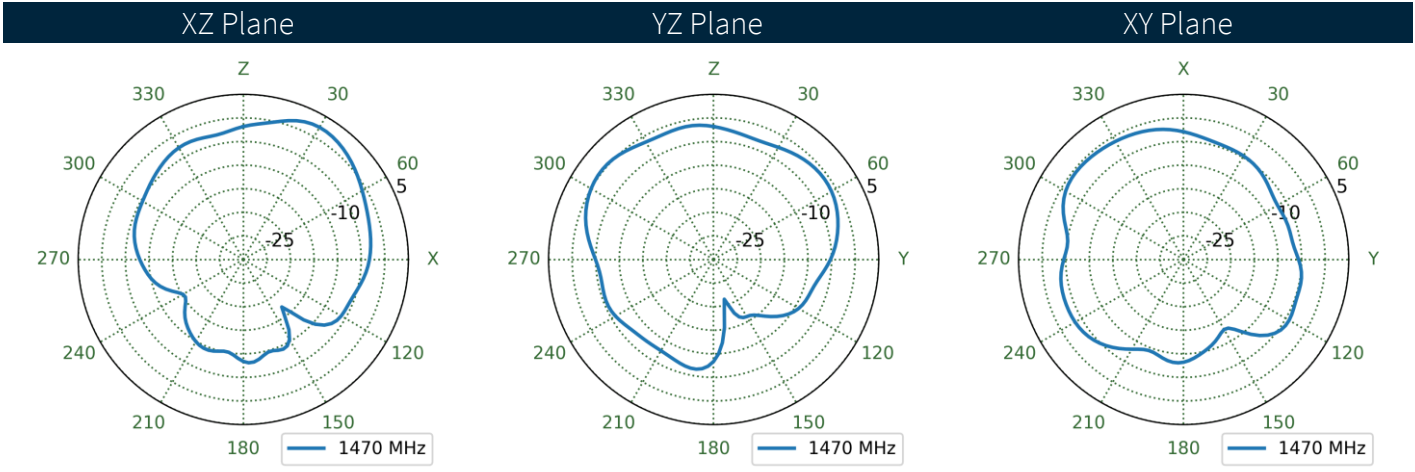
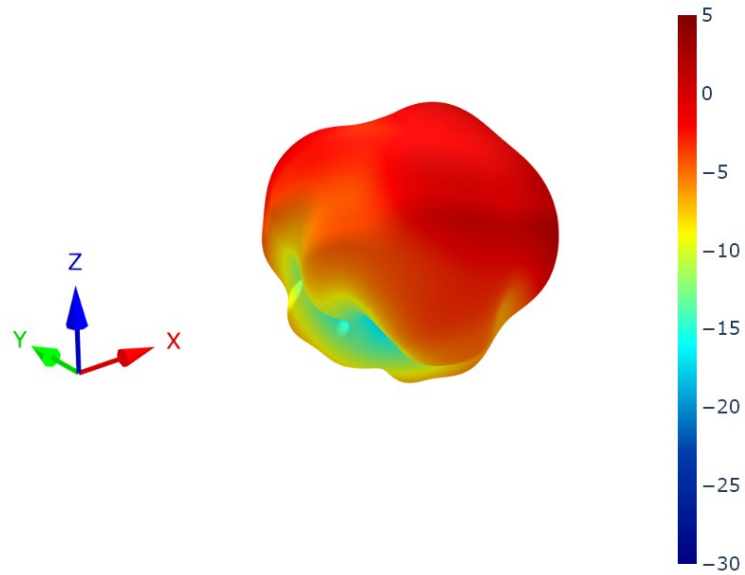

8.30 Cellular 3 Patterns at 1470 MHz

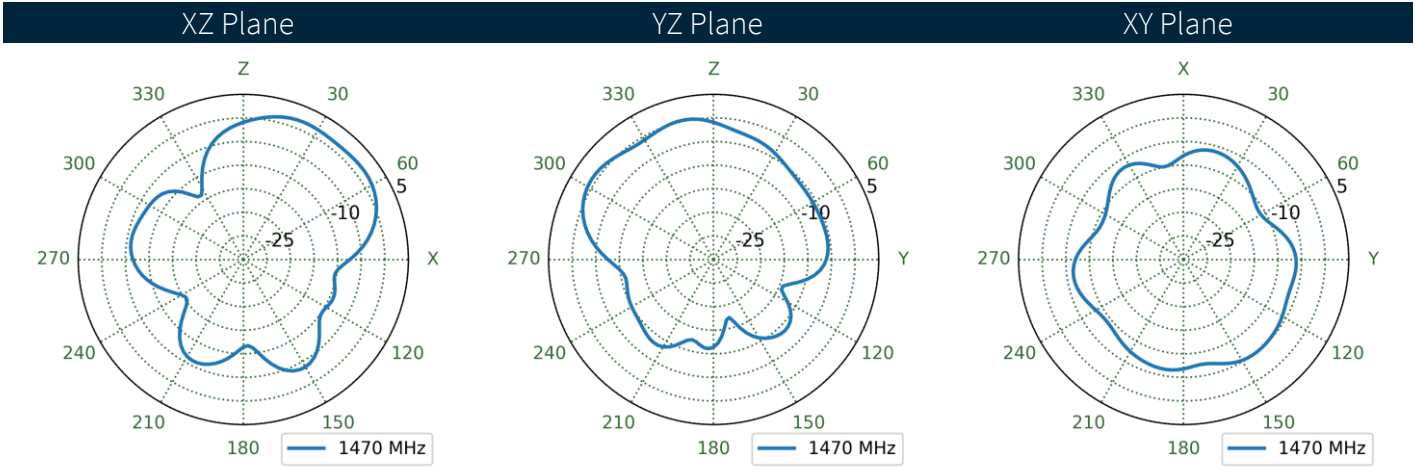
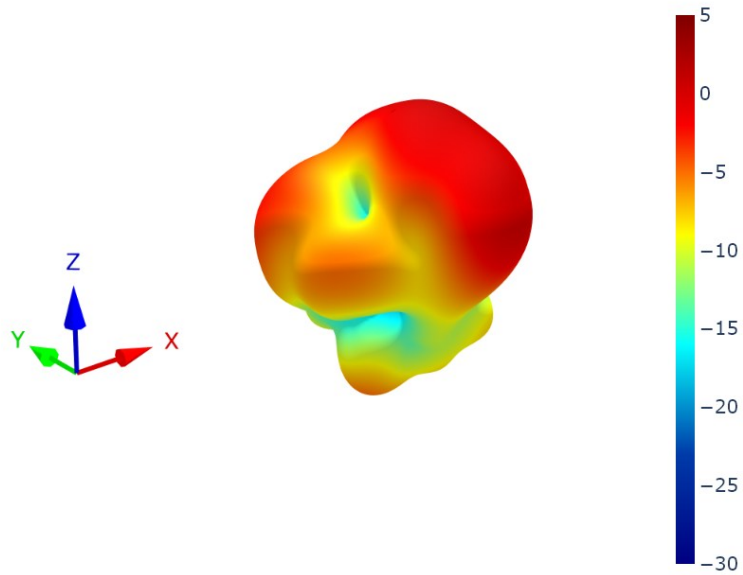

8.31 Cellular 4 Patterns at 1470 MHz

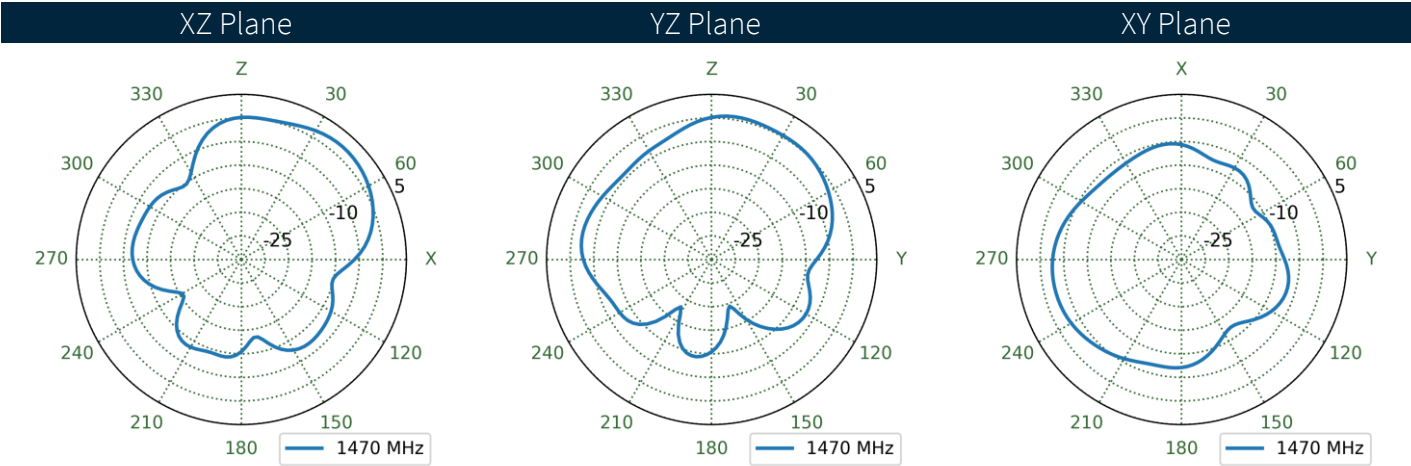
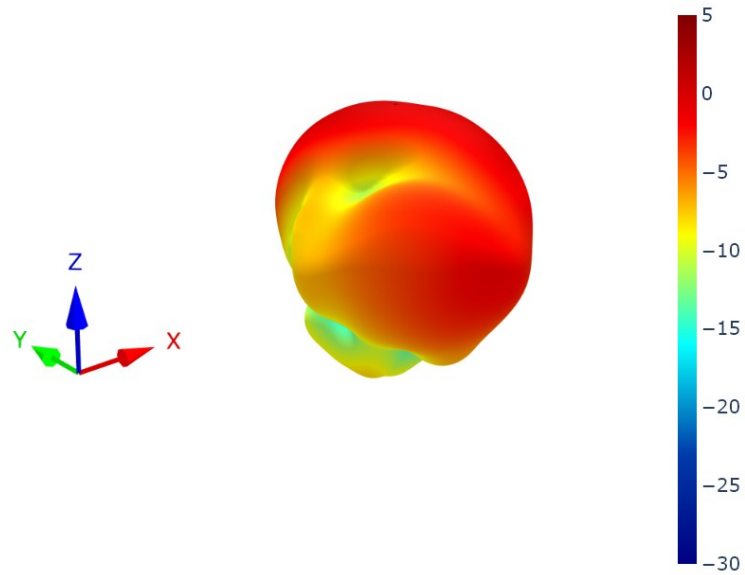

8.32 Cellular 5 Patterns at 1470 MHz

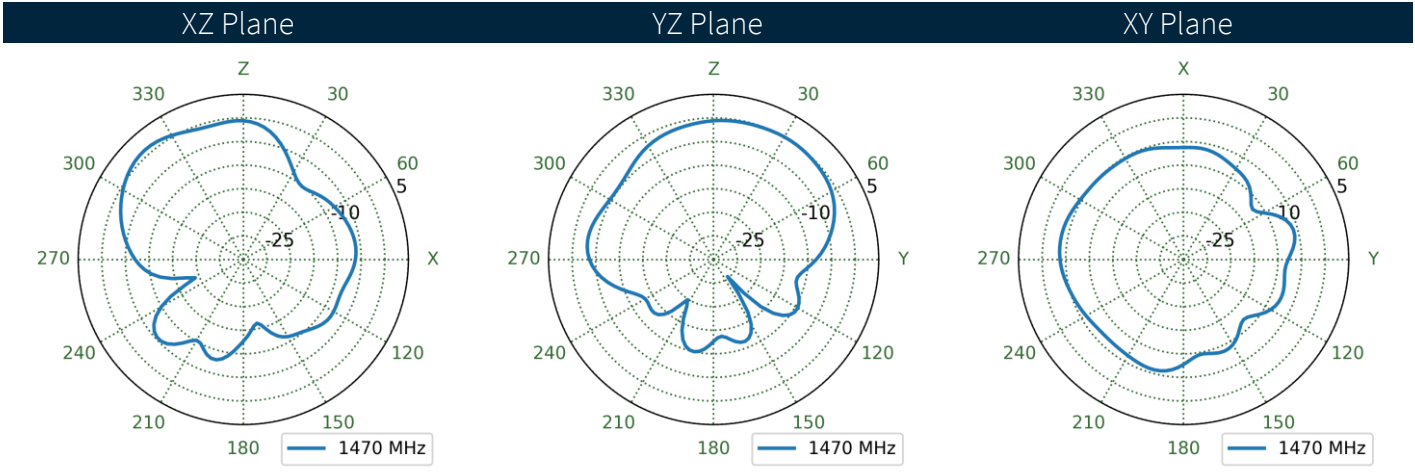
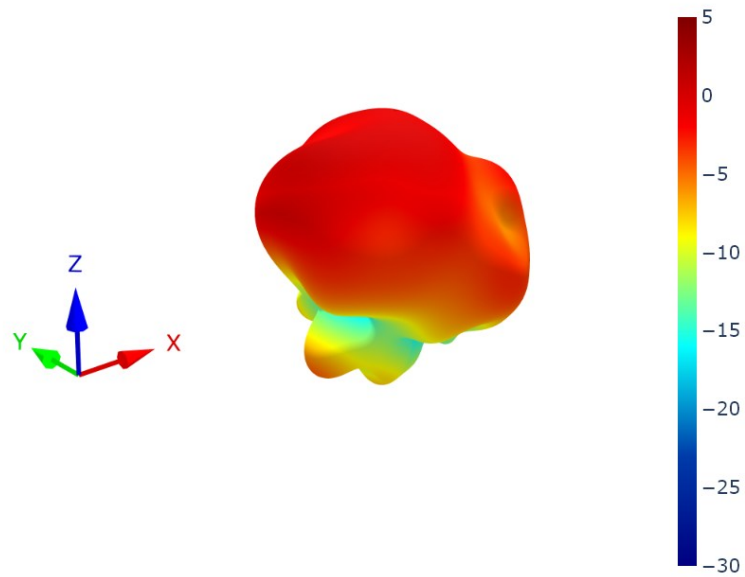

8.33 Cellular 6 Patterns at 1470 MHz

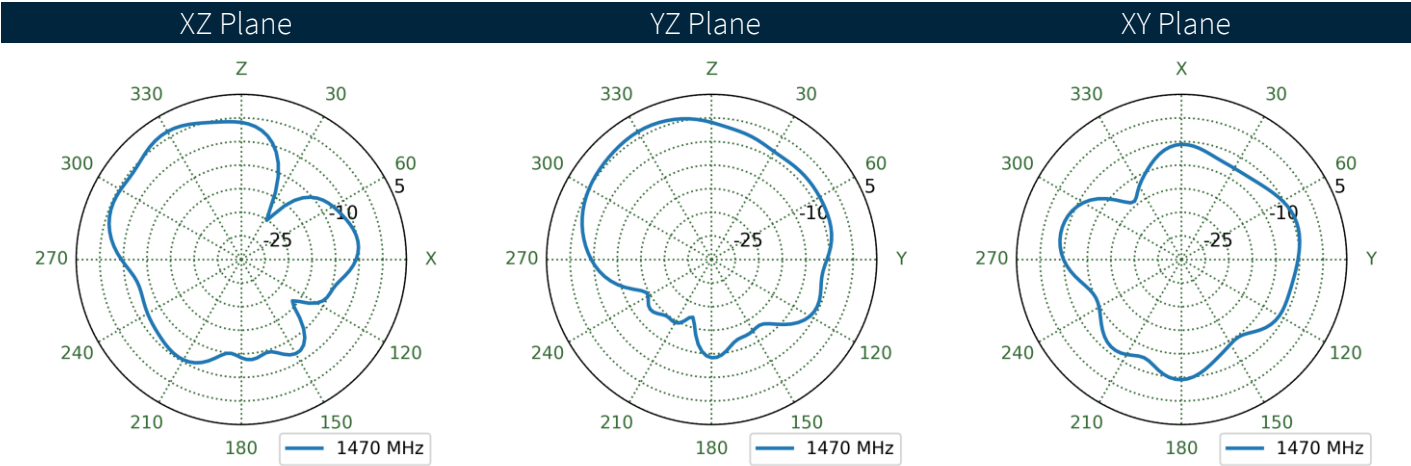
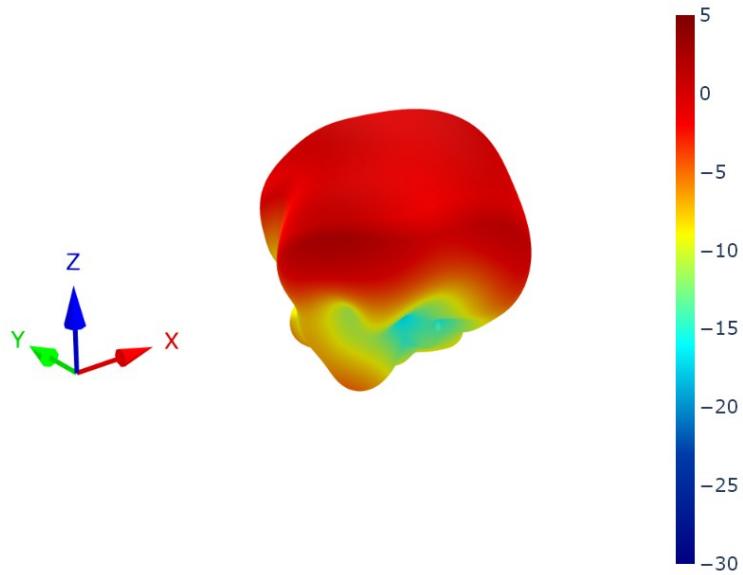

8.34 Cellular 7 Patterns at 1470 MHz

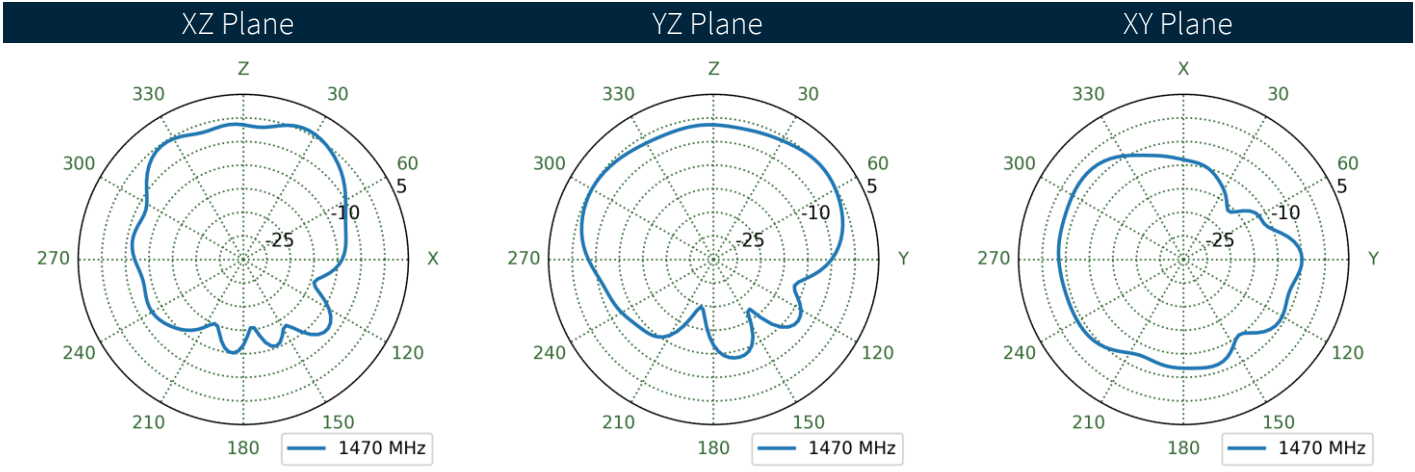
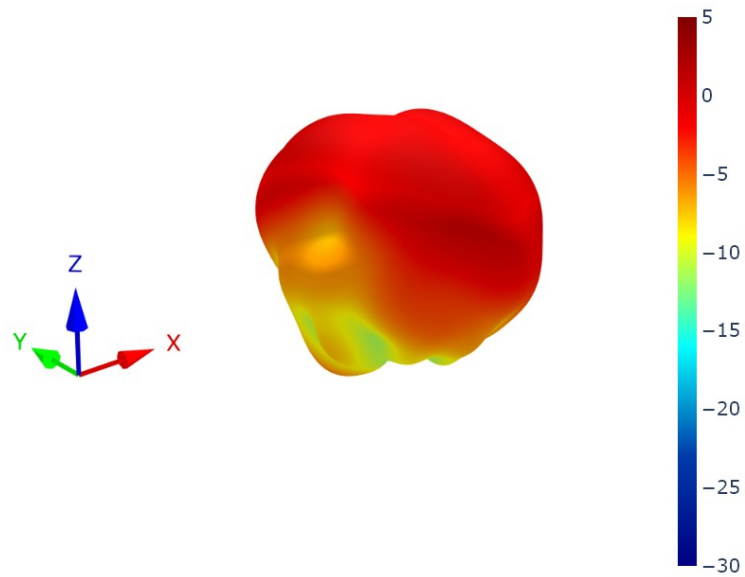

8.35 Cellular 8 Patterns at 1470 MHz

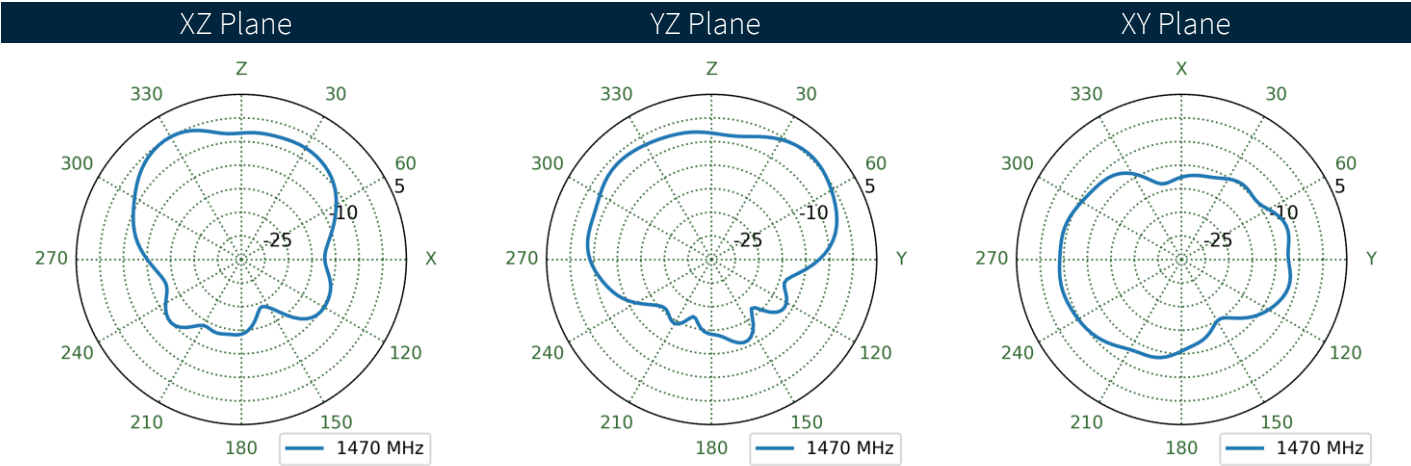
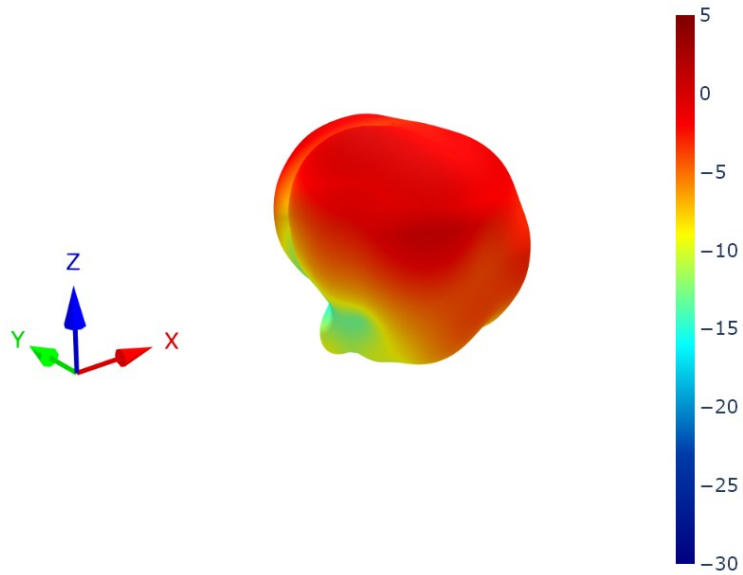

8.36 Cellular 1 Patterns at 1805 MHz

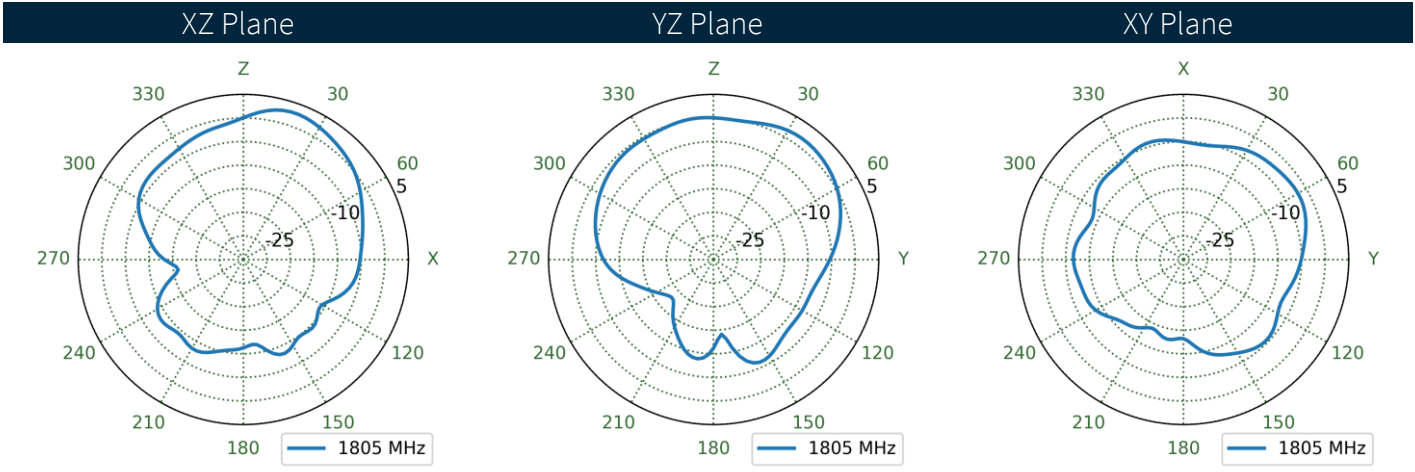
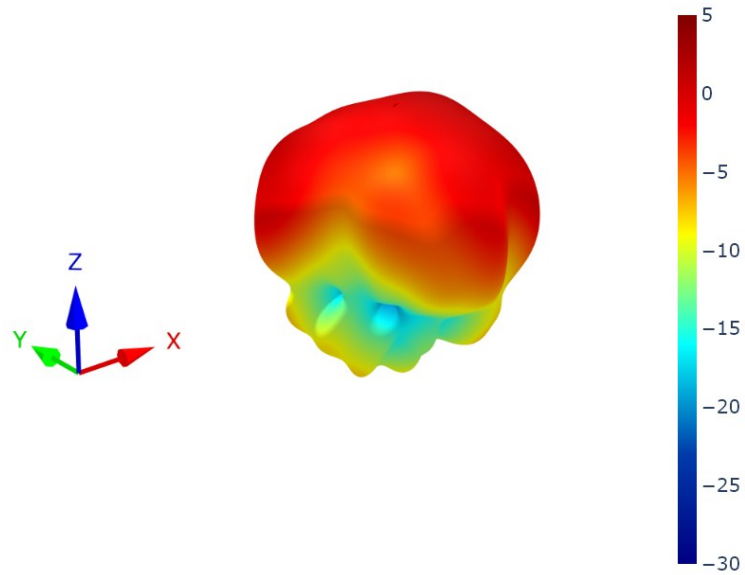

8.37 Cellular 2 Patterns at 1805 MHz

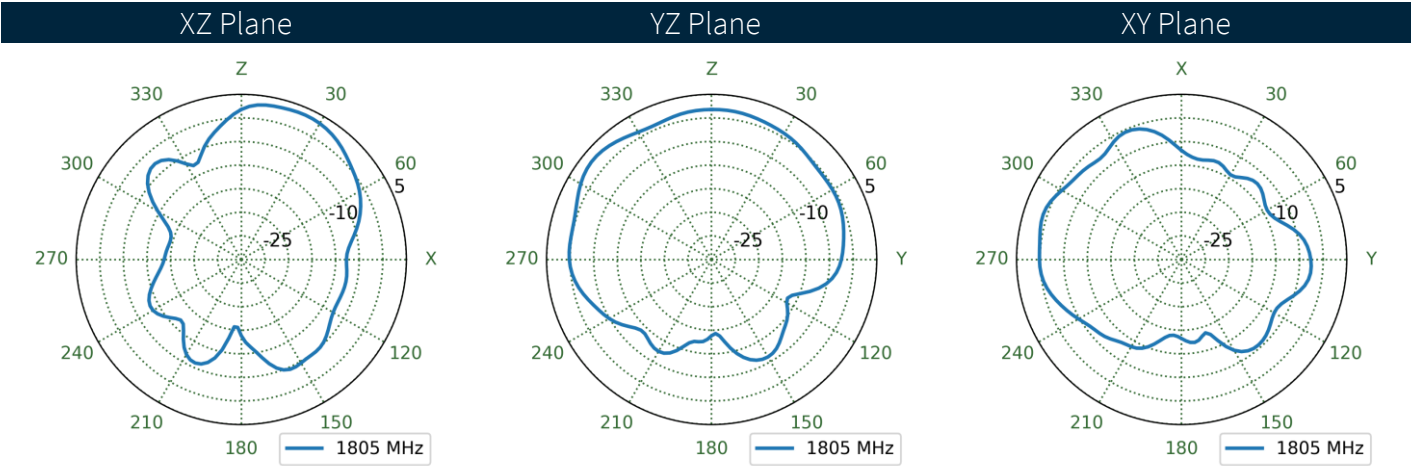
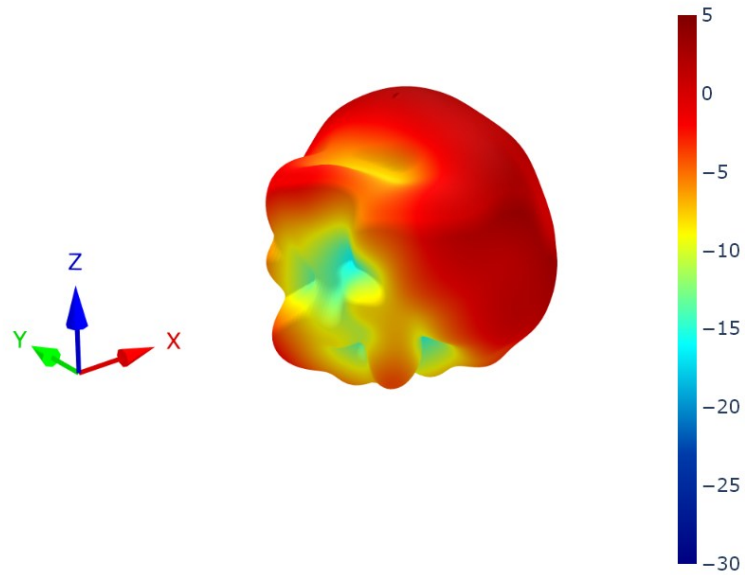

8.38 Cellular 3 Patterns at 1805 MHz

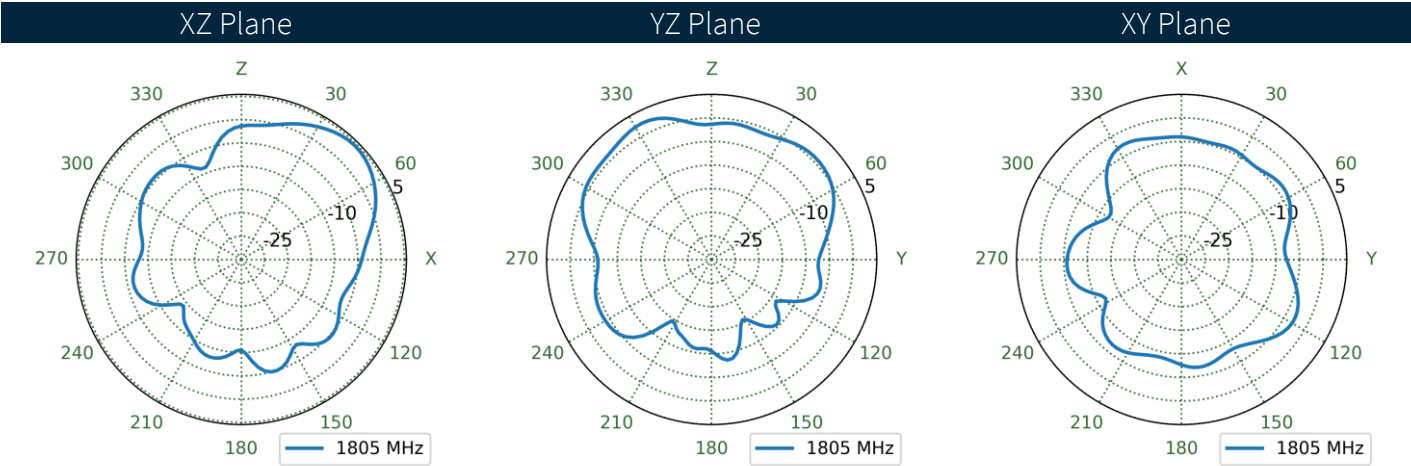
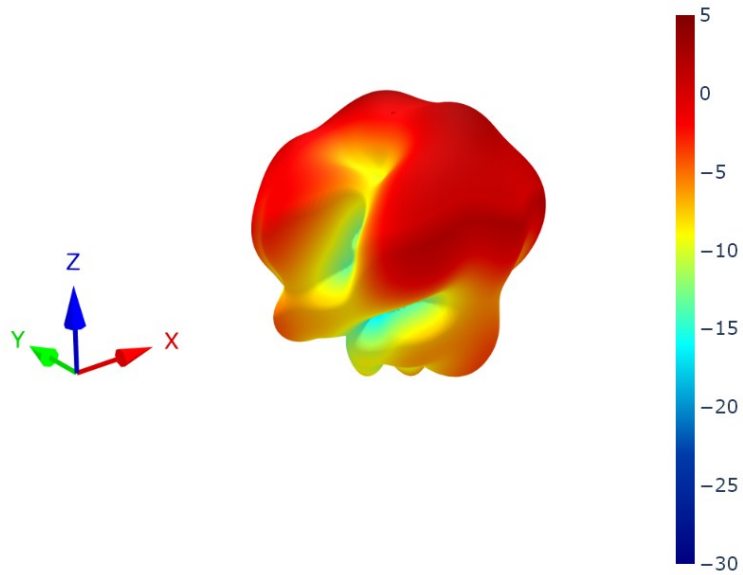

8.39 Cellular 4 Patterns at 1805 MHz

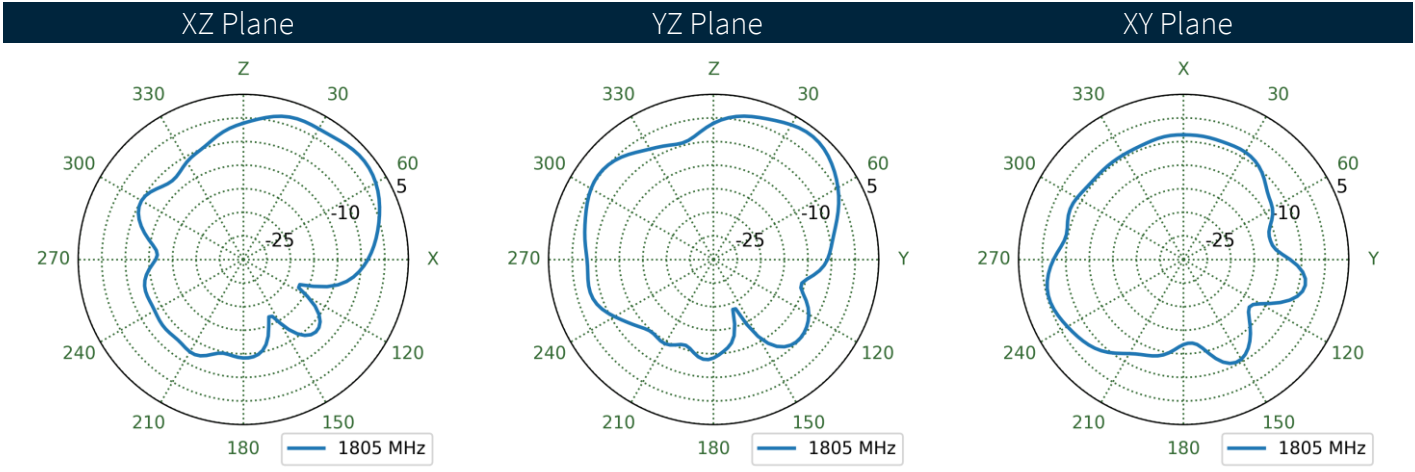
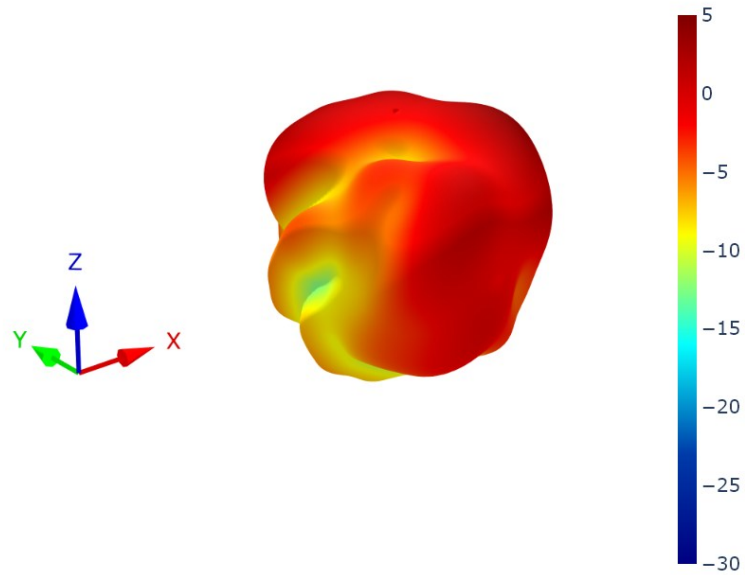

8.40 Cellular 5 Patterns at 1805 MHz

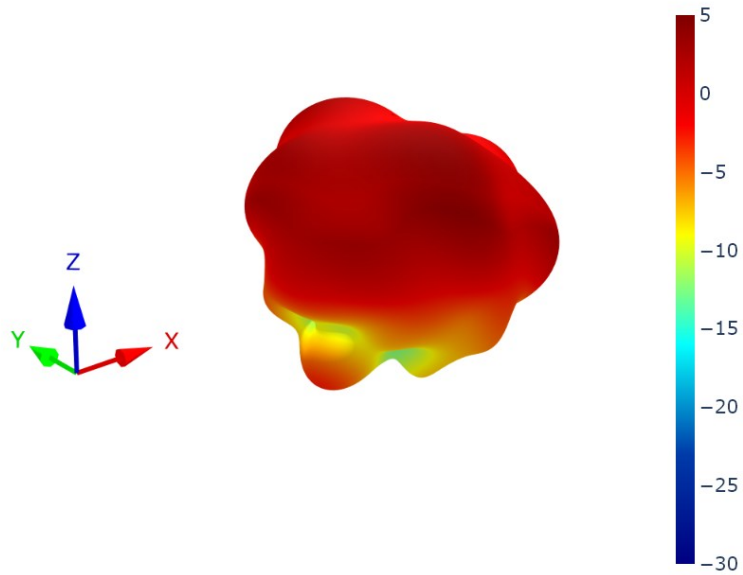

XZ Plane YZ Plane XY Plane

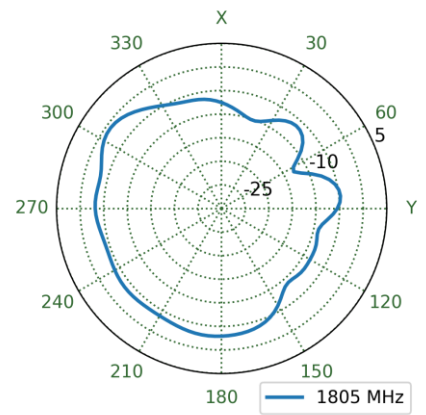
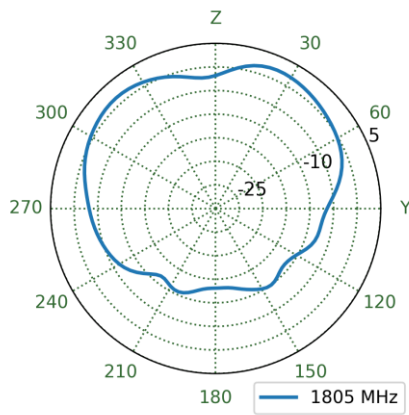
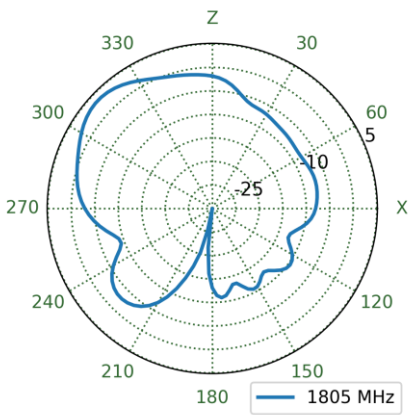

8.41 Cellular 6 Patterns at 1805 MHz

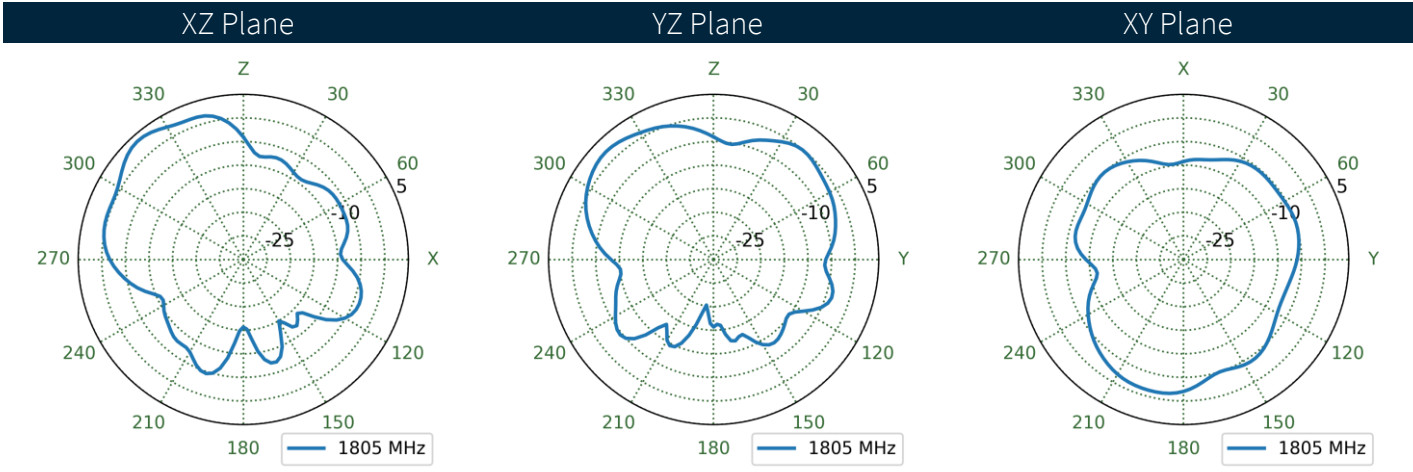
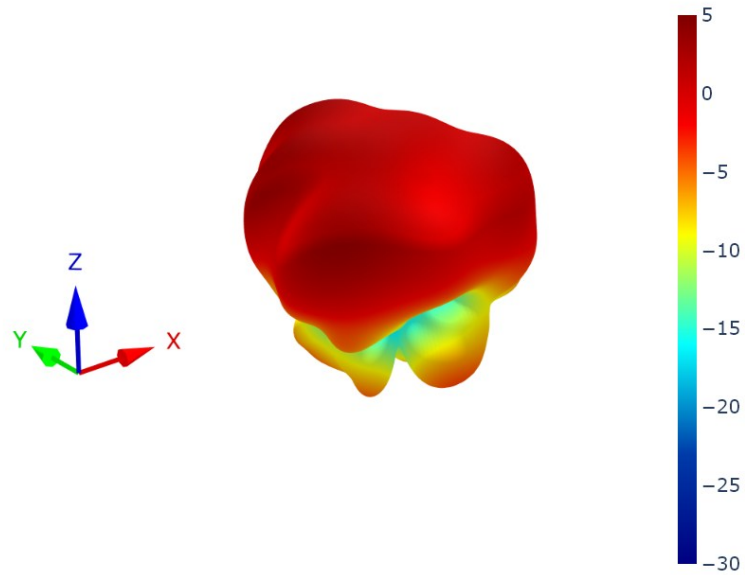

8.42 Cellular 7 Patterns at 1805 MHz

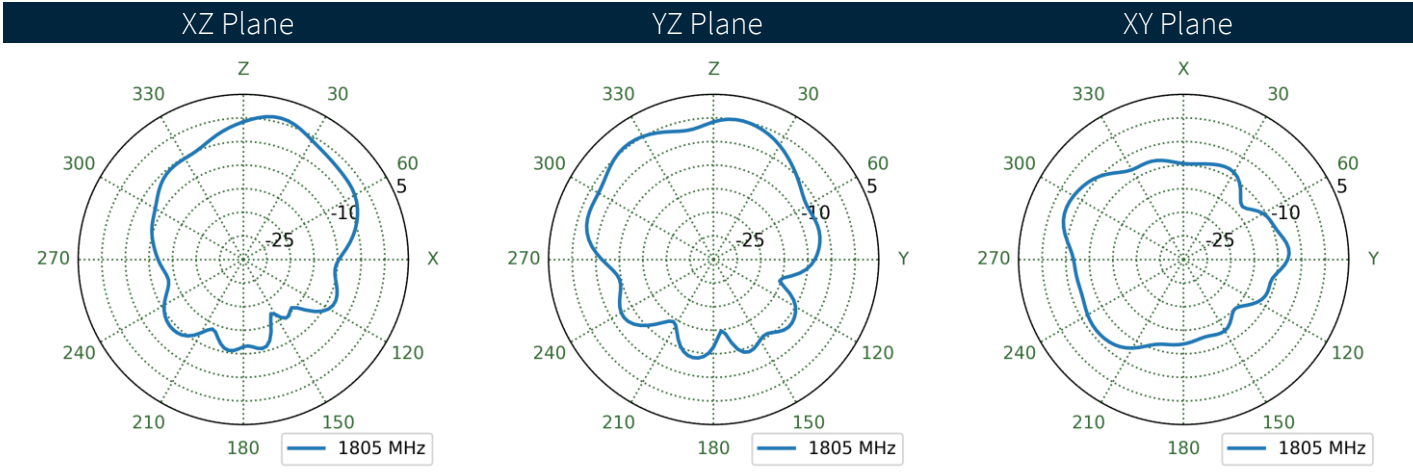
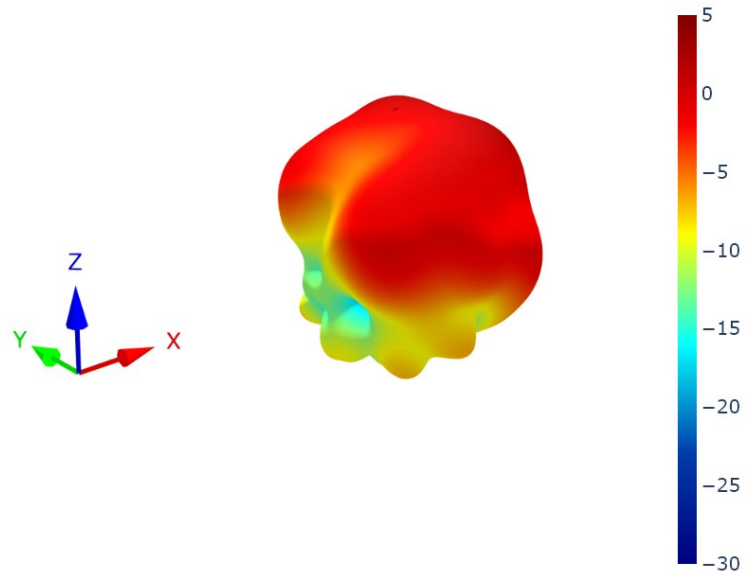

8.43 Cellular 8 Patterns at 1805 MHz

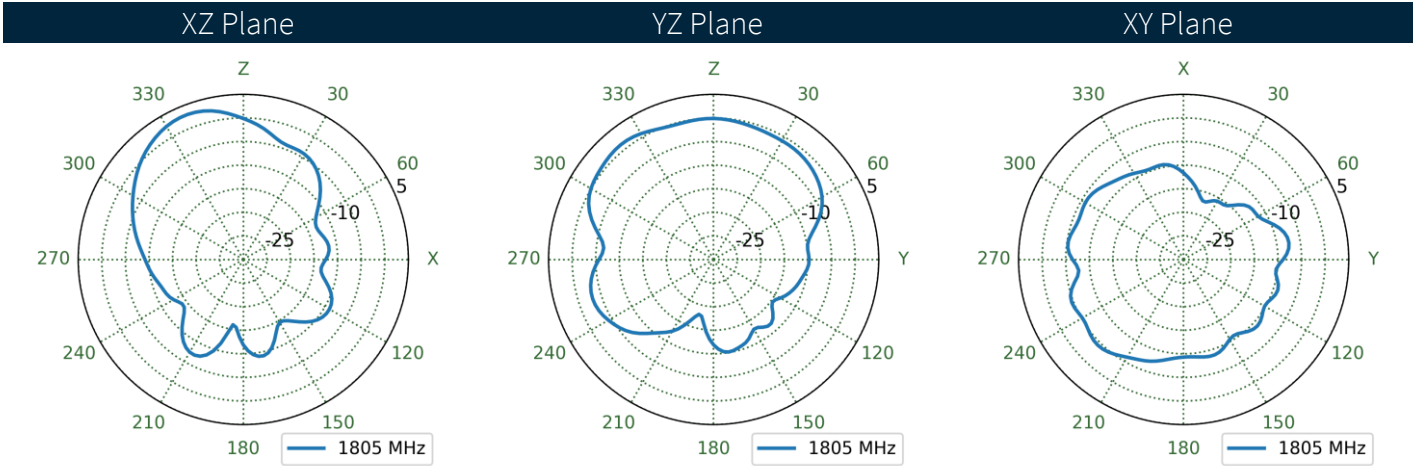
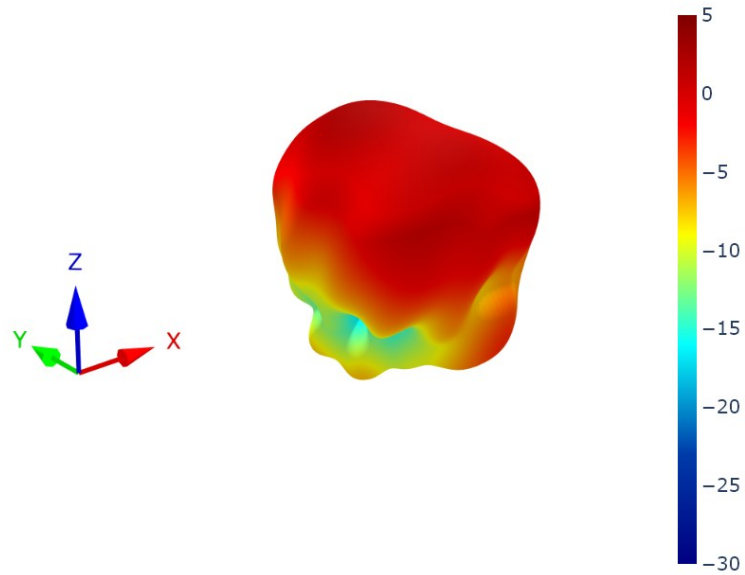

8.44 Cellular 1 Patterns at 1920 MHz

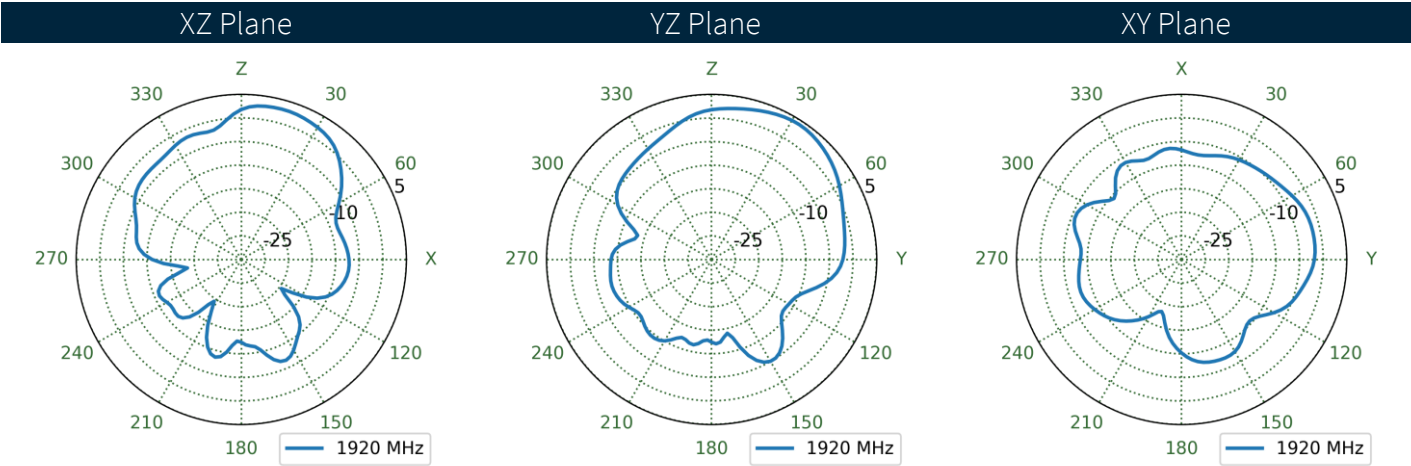
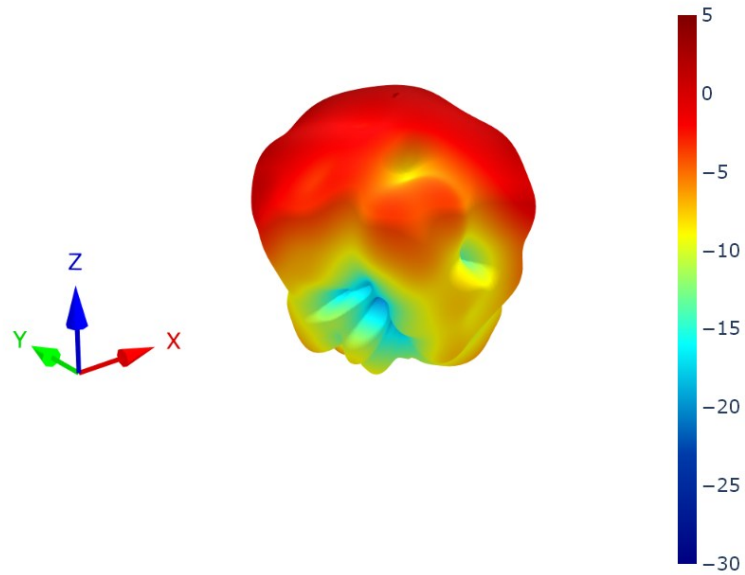

8.45 Cellular 2 Patterns at 1920 MHz

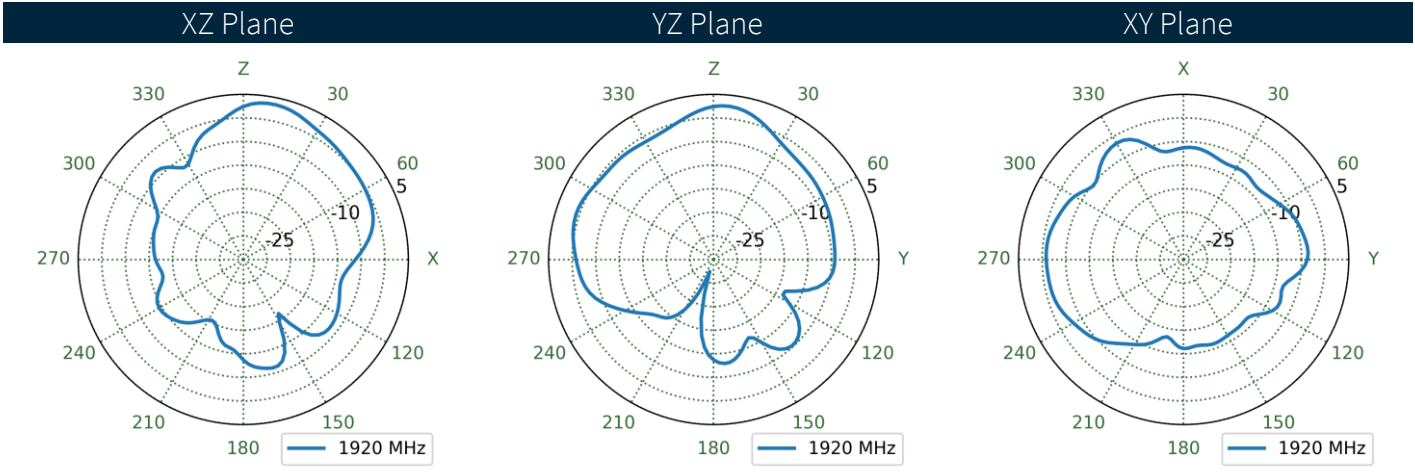
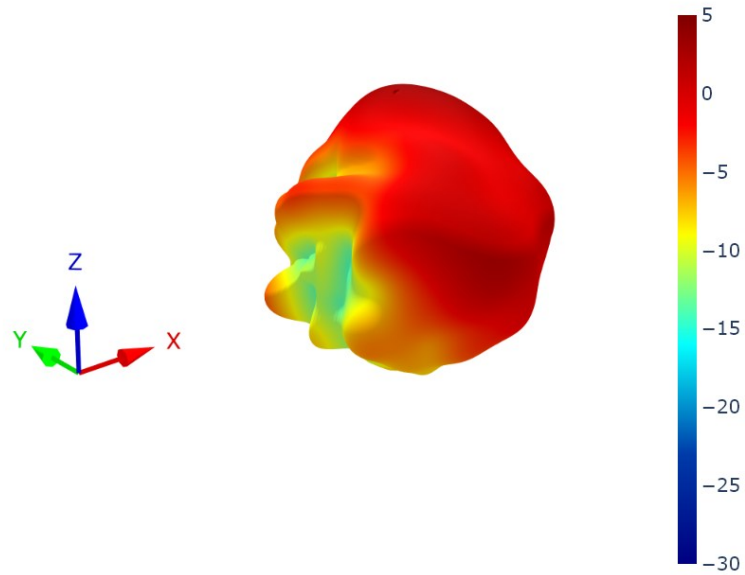

8.46 Cellular 3 Patterns at 1920 MHz

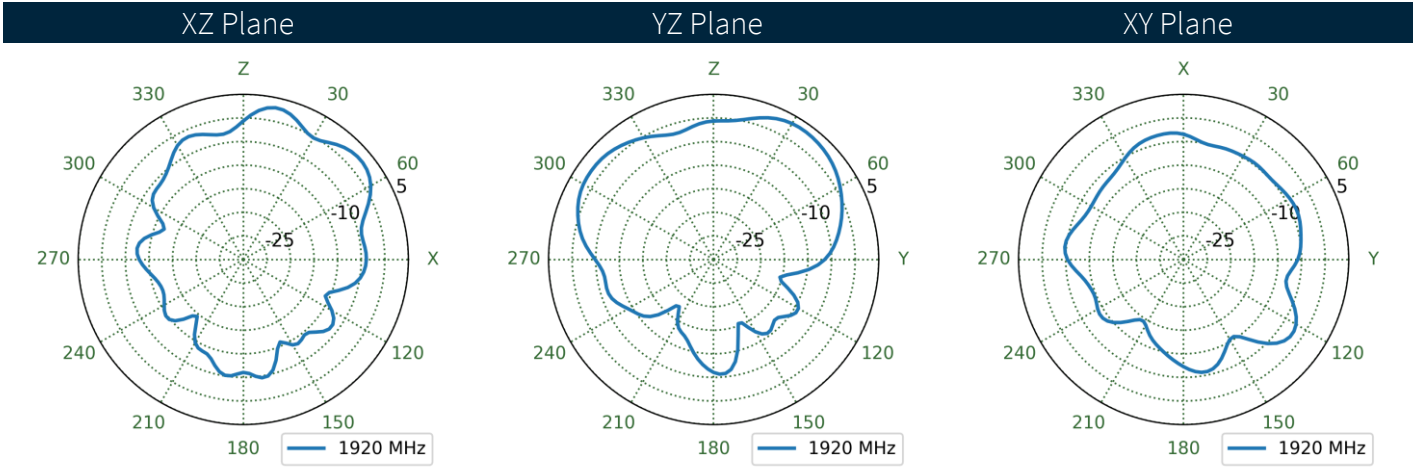
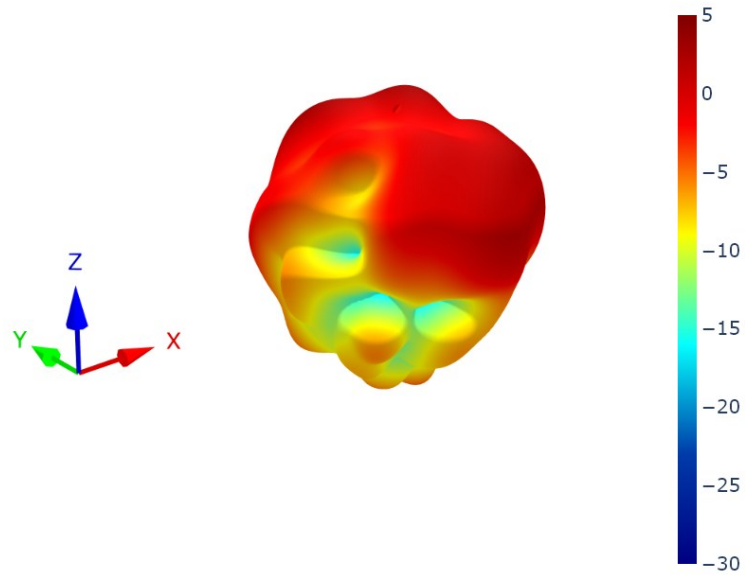

8.47 Cellular 4 Patterns at 1920 MHz

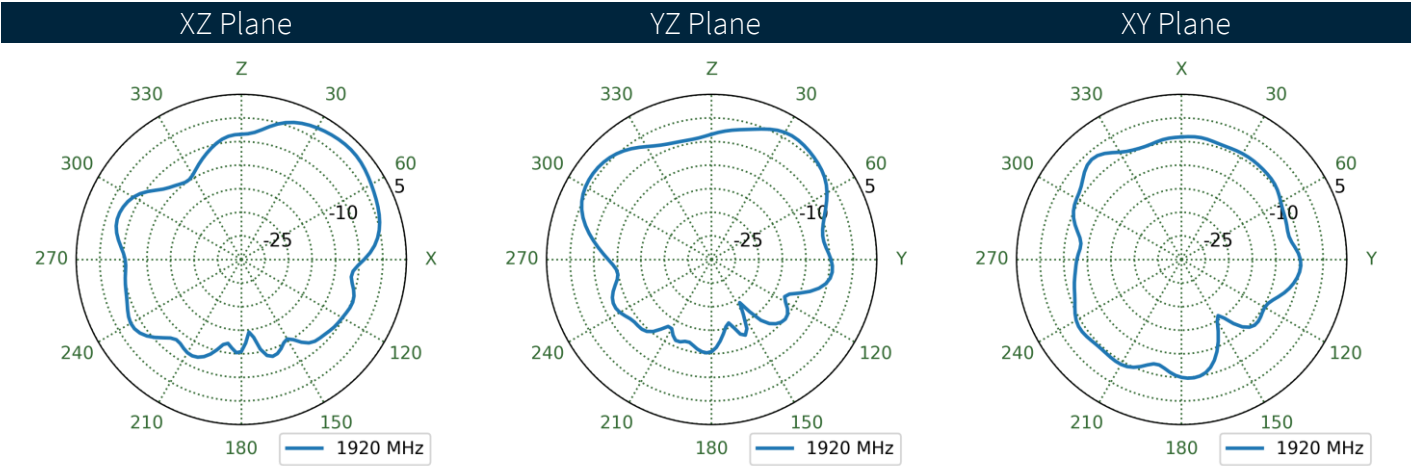
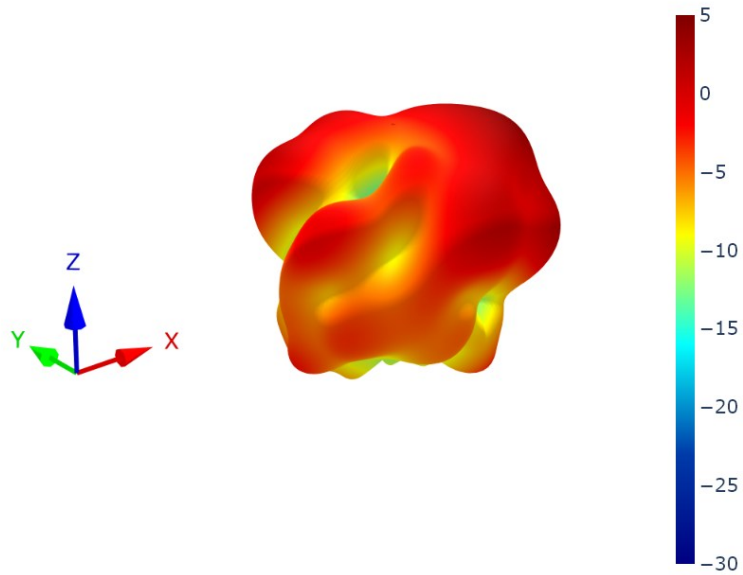

8.48 Cellular 5 Patterns at 1920 MHz

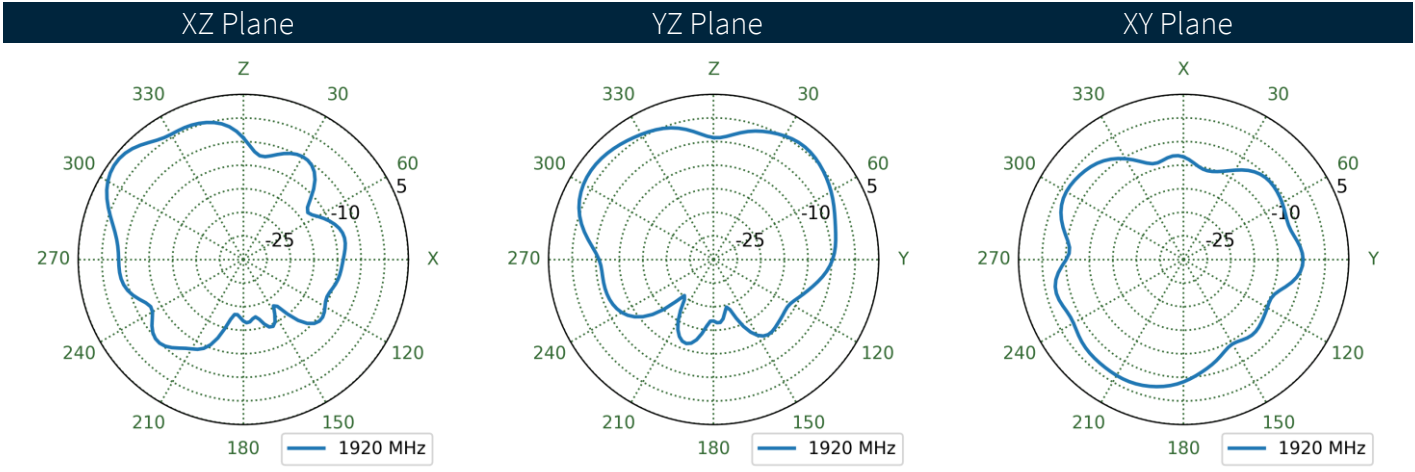
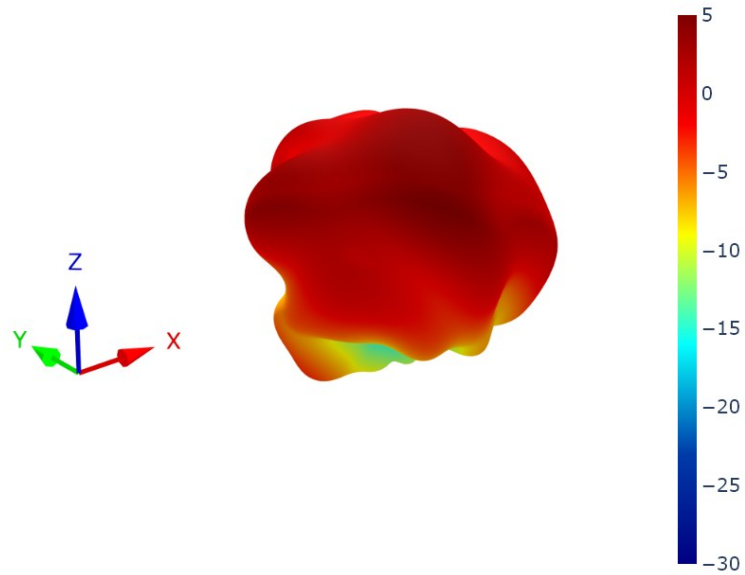

8.49 Cellular 6 Patterns at 1920 MHz

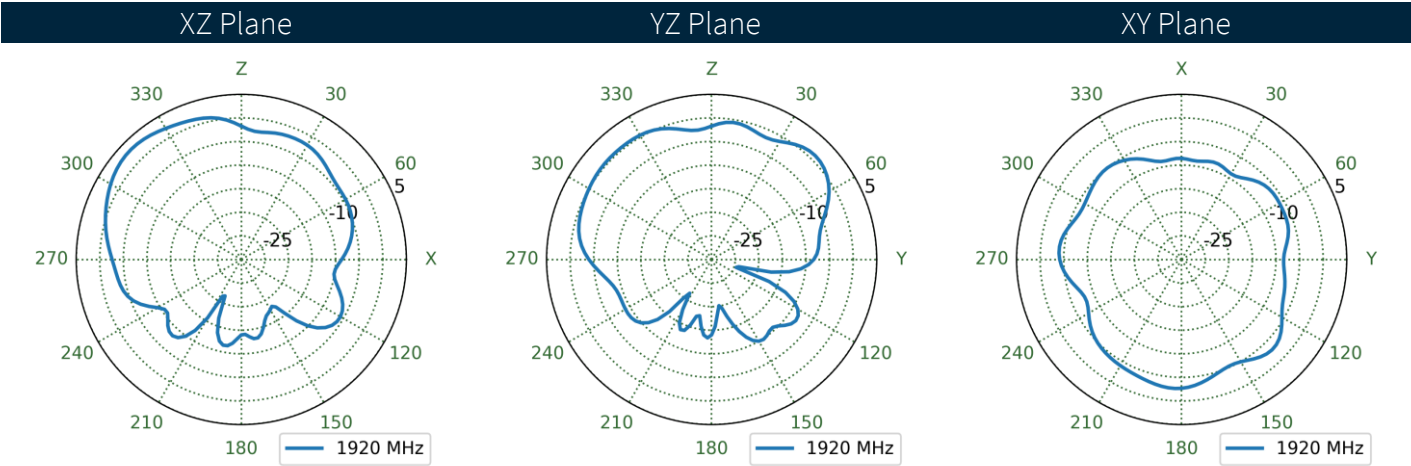
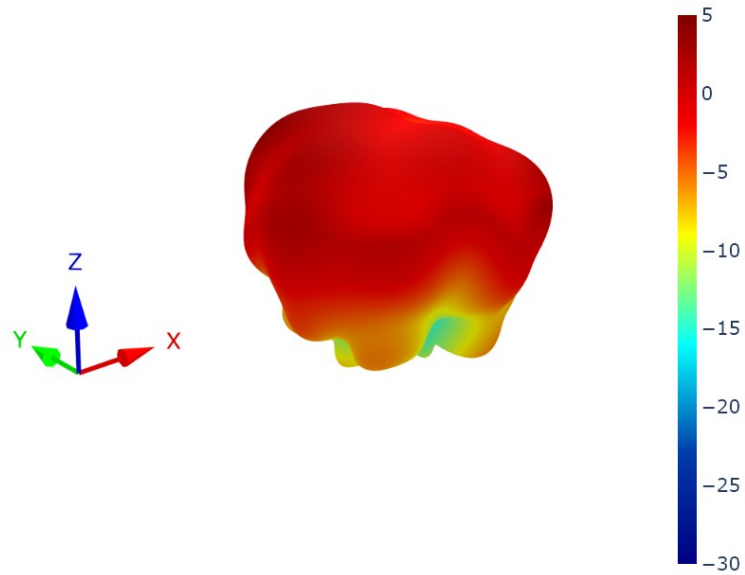

8.50 Cellular 7 Patterns at 1920 MHz

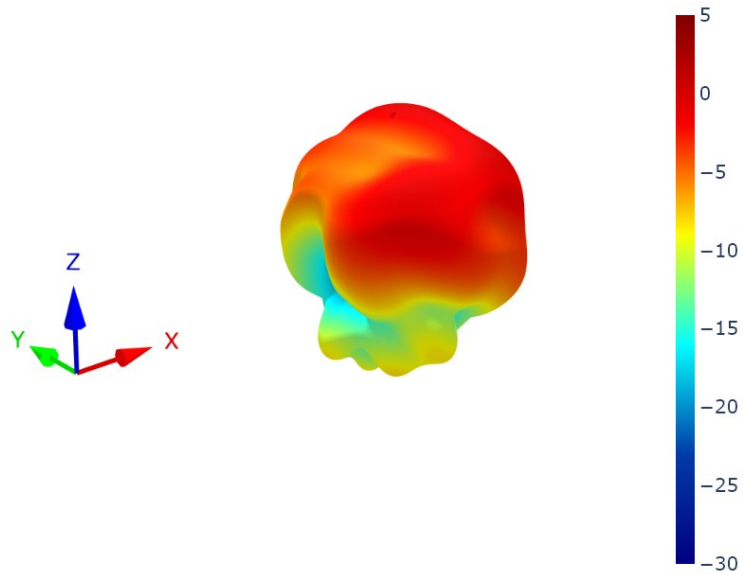

XZ Plane YZ Plane XY Plane

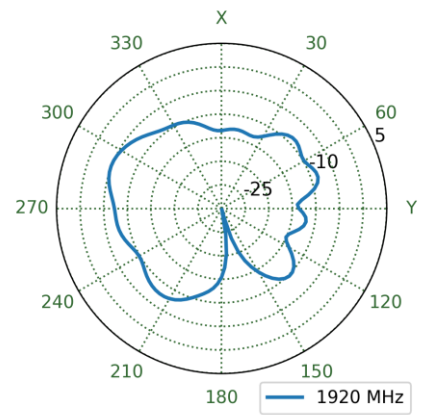
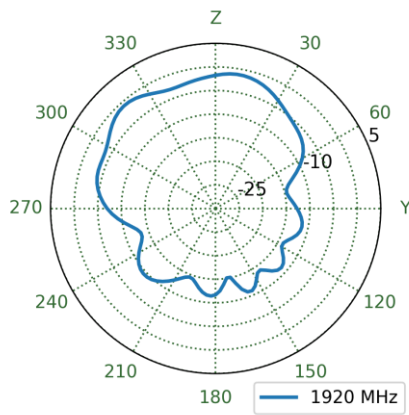
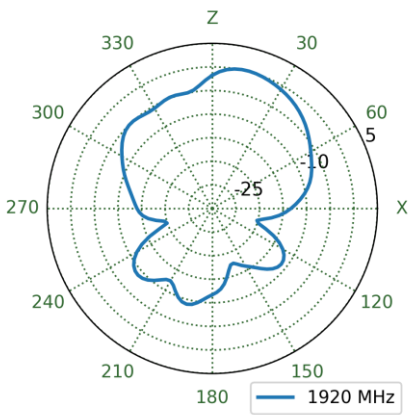

8.51 Cellular 8 Patterns at 1920 MHz

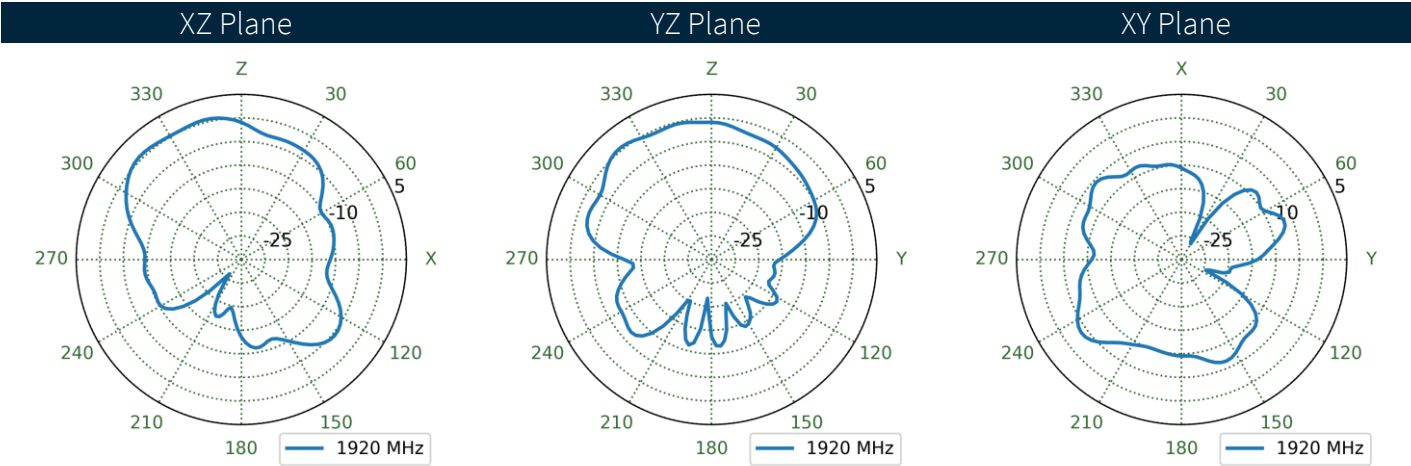
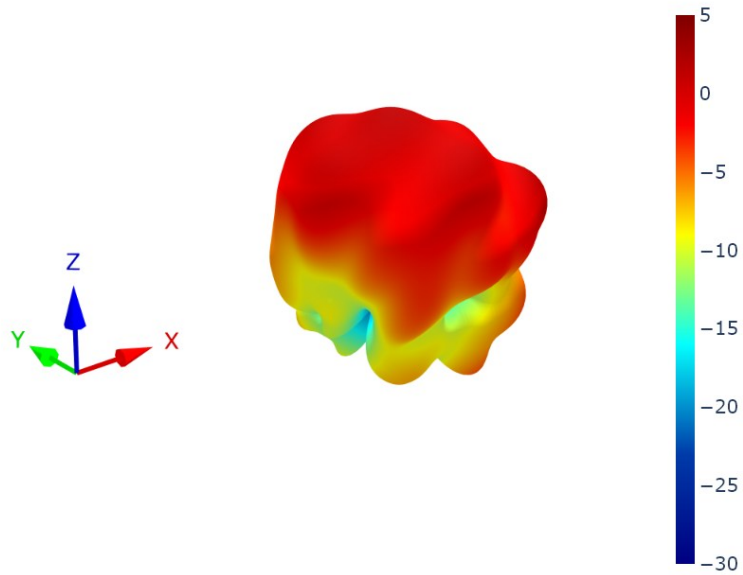

8.52 Cellular 1 Patterns at 1990 MHz

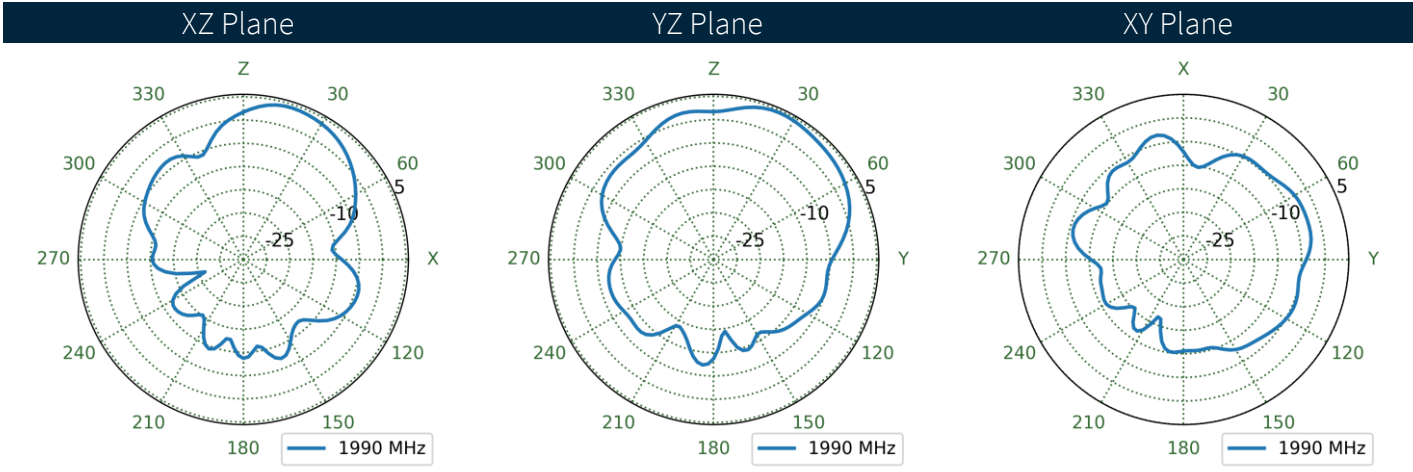
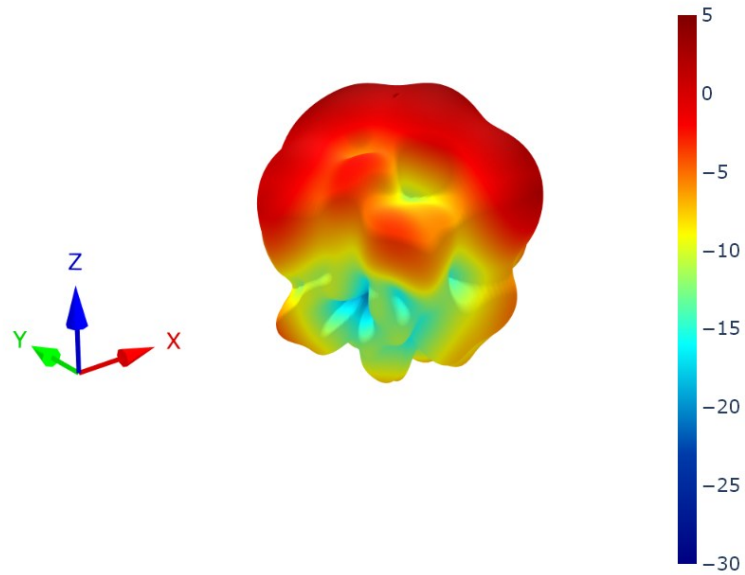

8.53 Cellular 2 Patterns at 1990 MHz

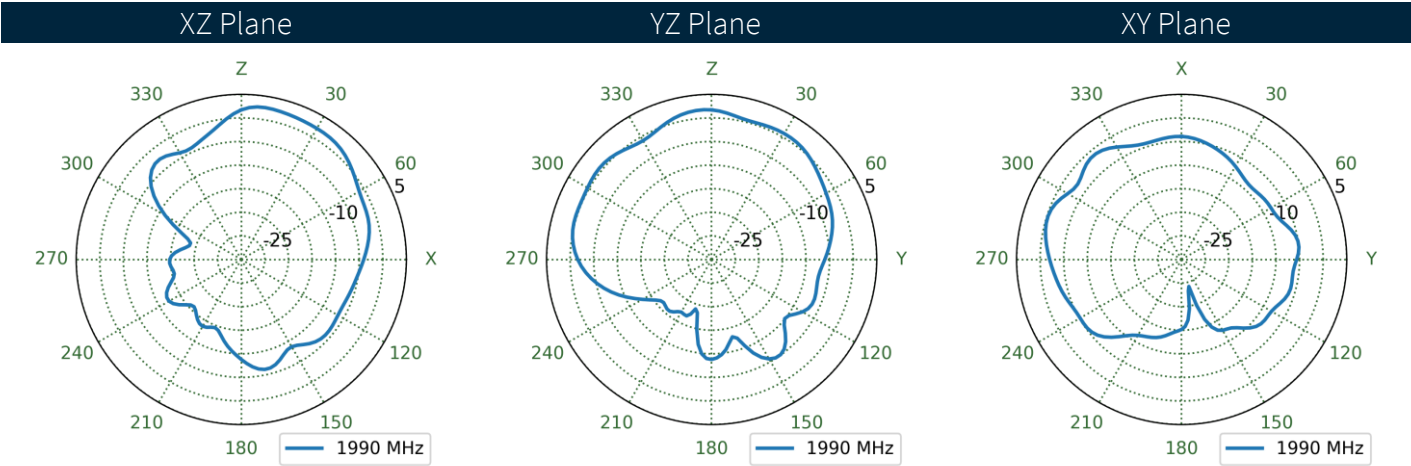
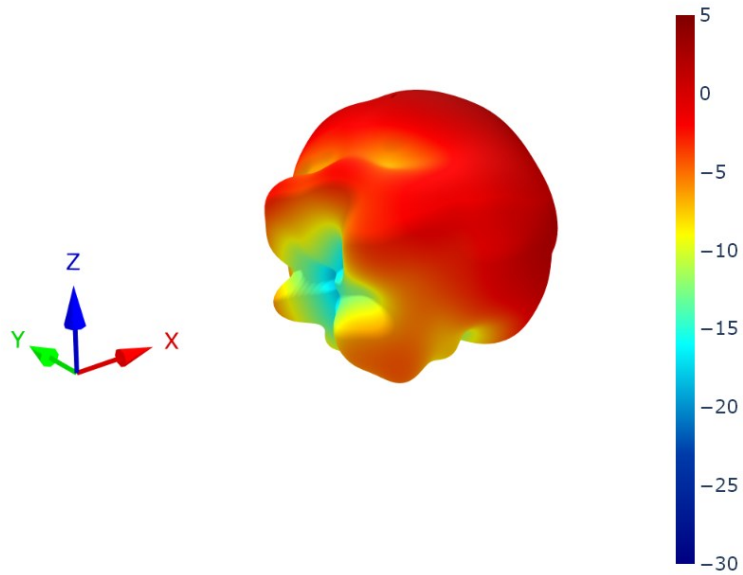

8.54 Cellular 3 Patterns at 1990 MHz

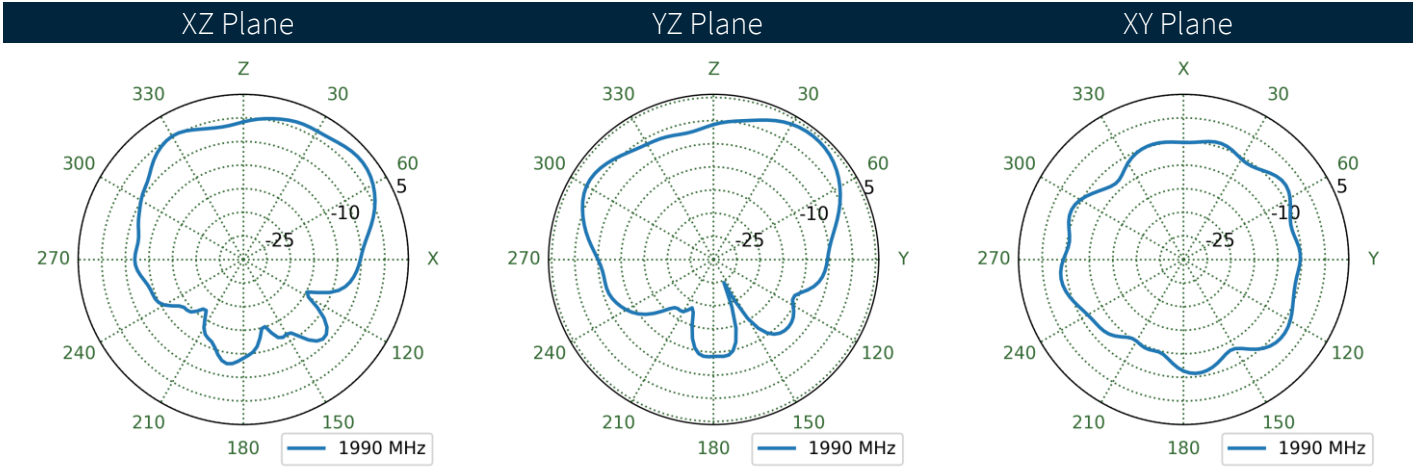
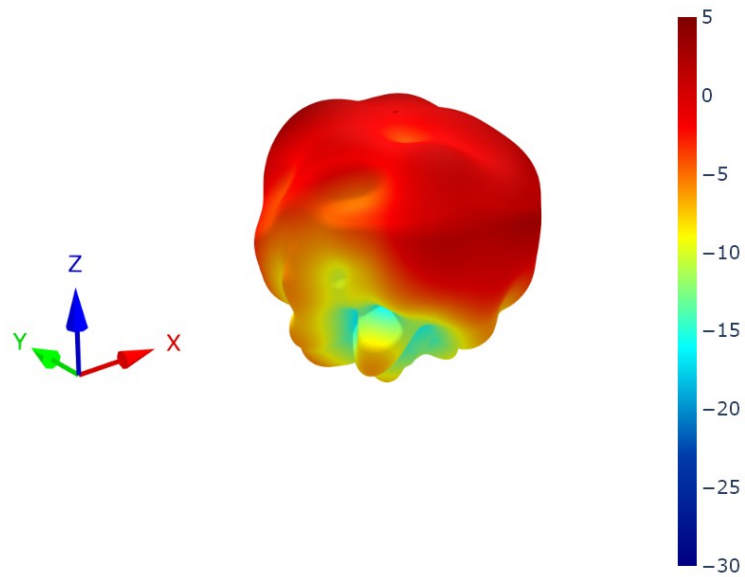

8.55 Cellular 4 Patterns at 1990 MHz

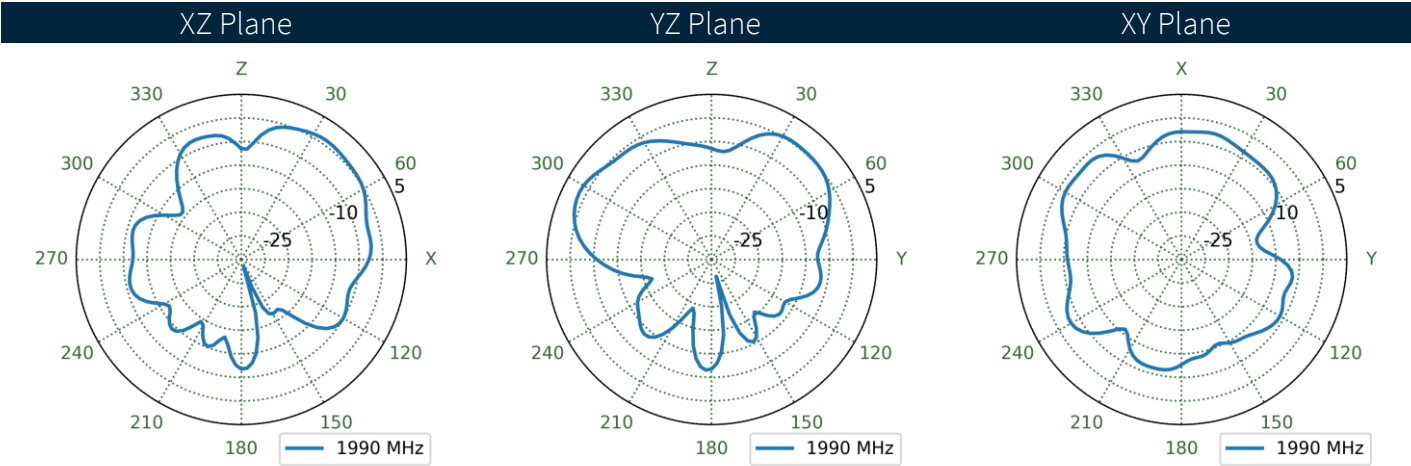
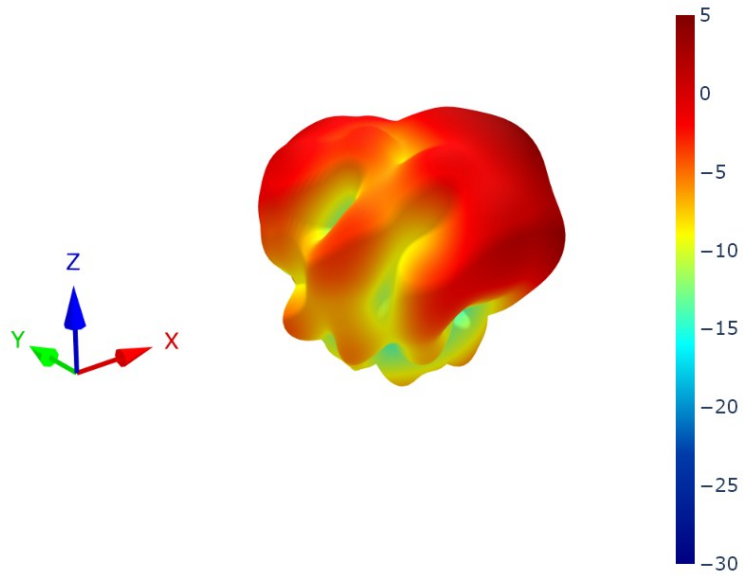

8.56 Cellular 5 Patterns at 1990 MHz

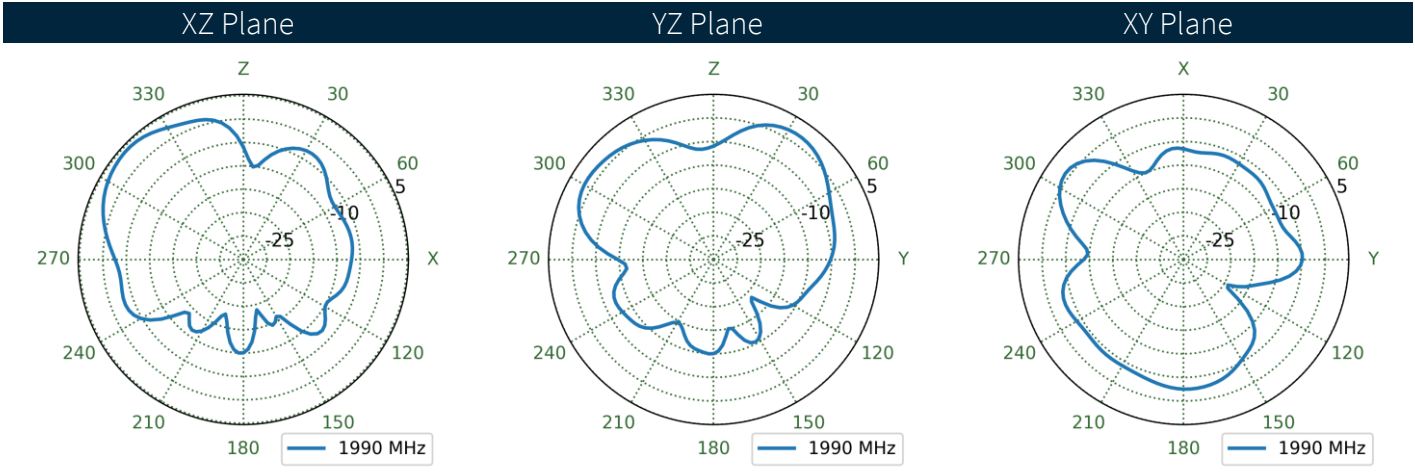
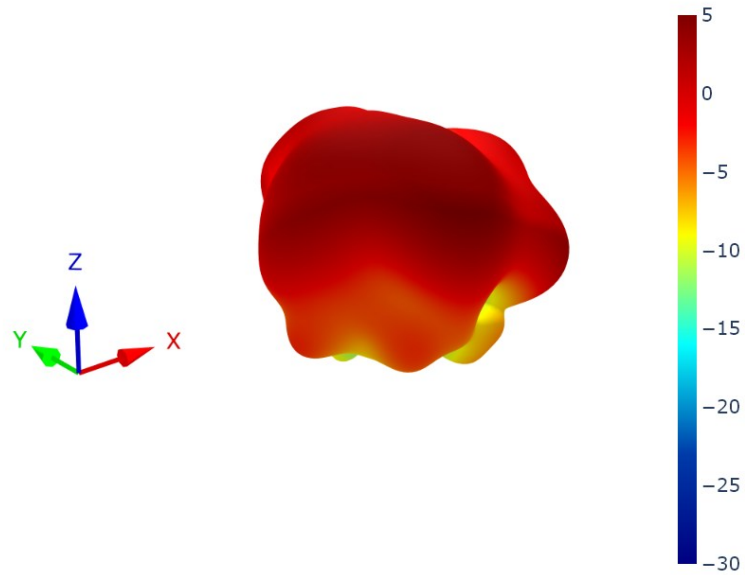

8.57 Cellular 6 Patterns at 1990 MHz

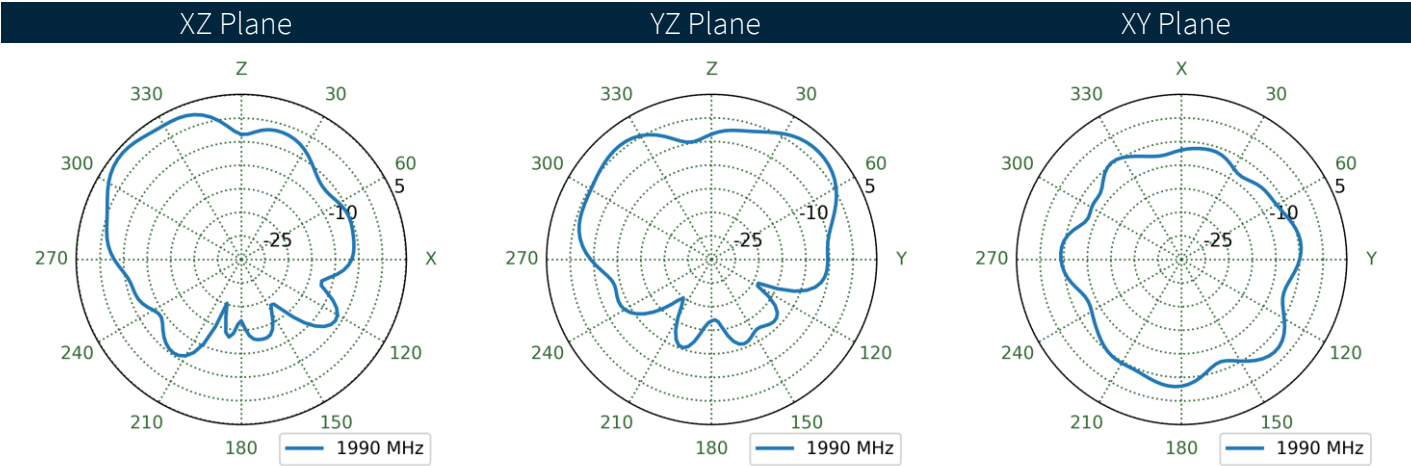
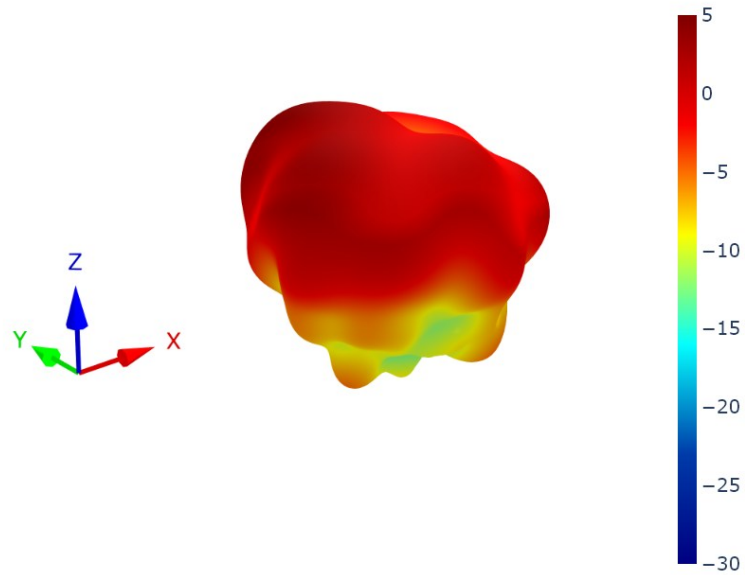

8.58 Cellular 7 Patterns at 1990 MHz

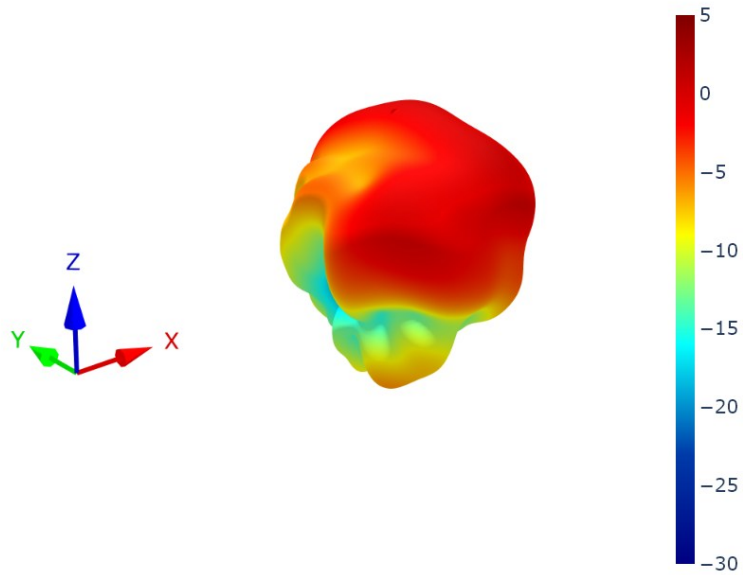

XZ Plane YZ Plane XY Plane

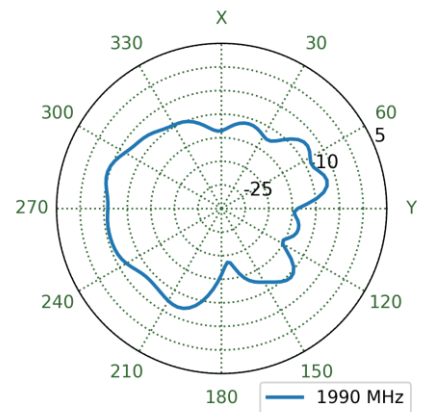
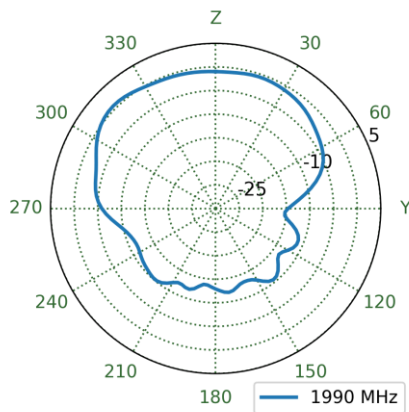
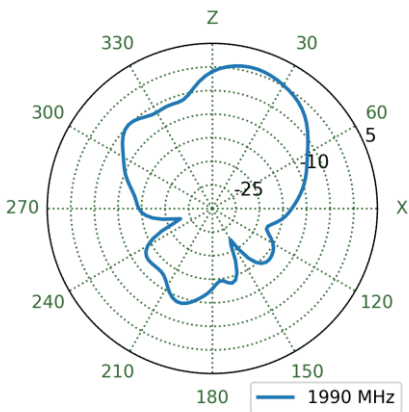

8.59 Cellular 8 Patterns at 1990 MHz

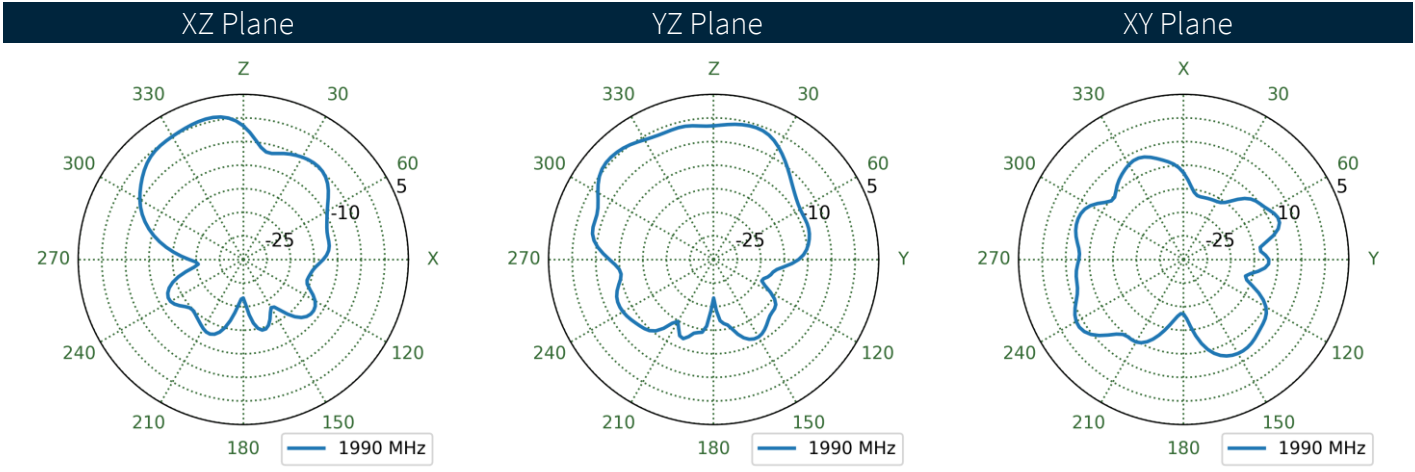
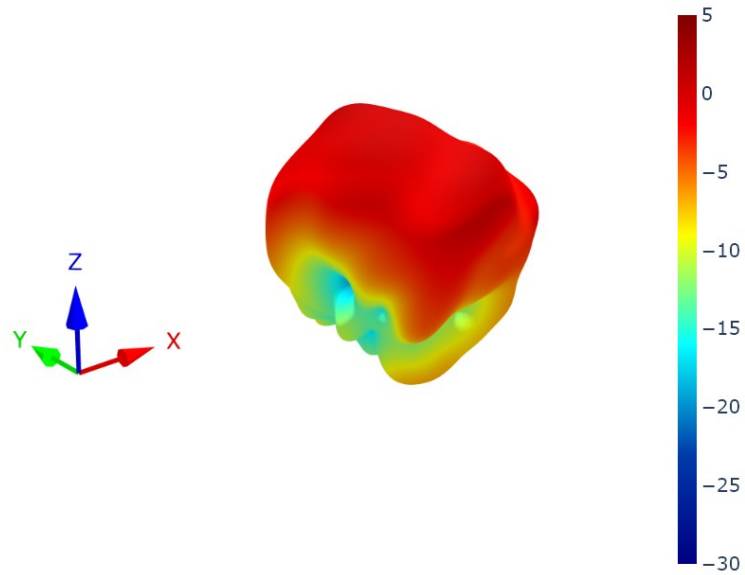

8.60 Cellular 1 Patterns at 2360 MHz

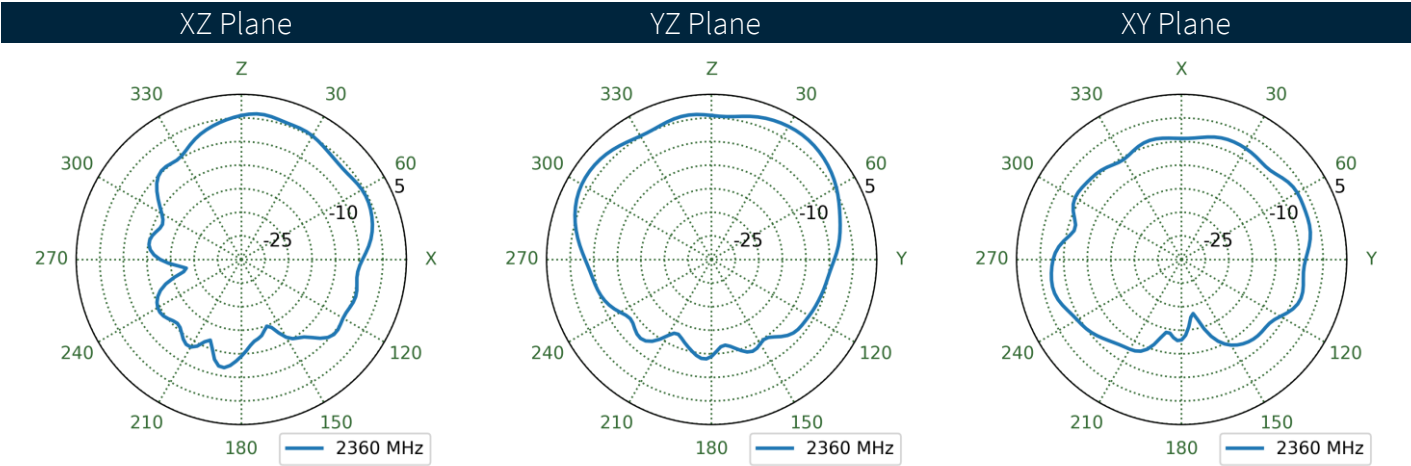
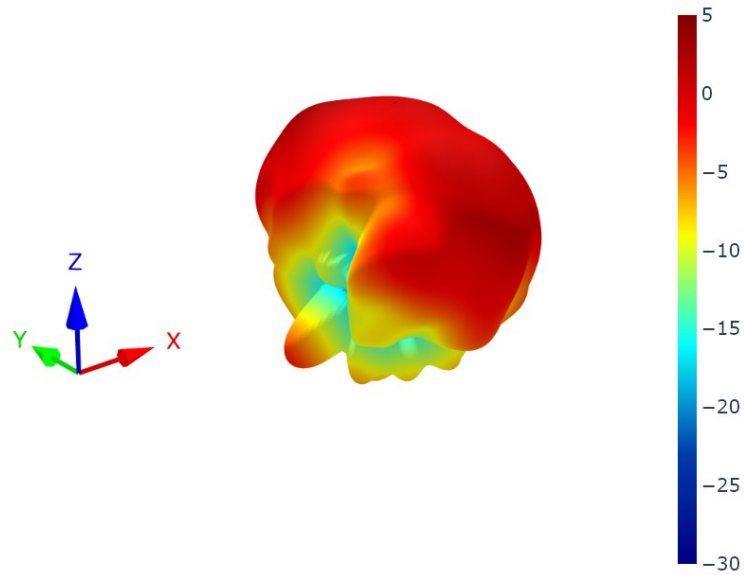

8.61 Cellular 2 Patterns at 2360 MHz

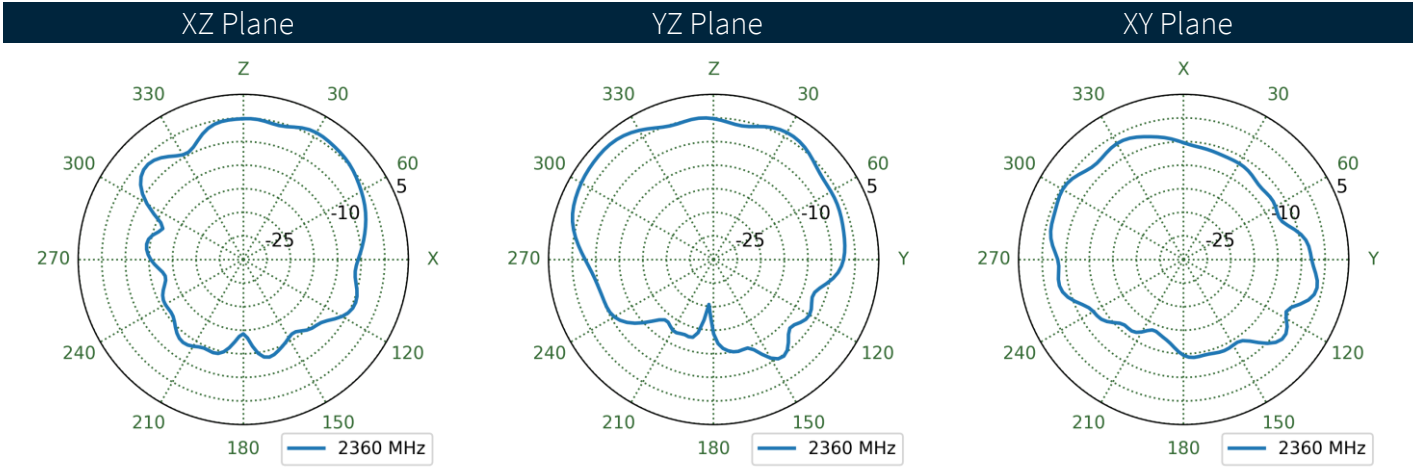
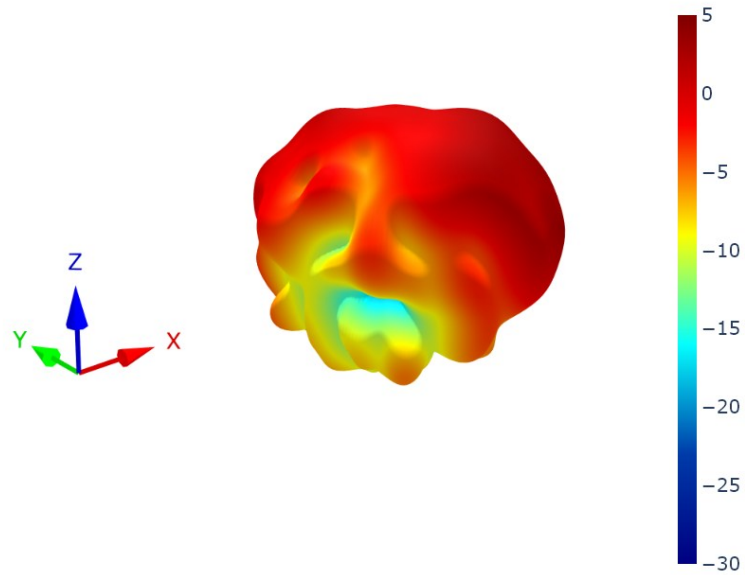

8.62 Cellular 3 Patterns at 2360 MHz

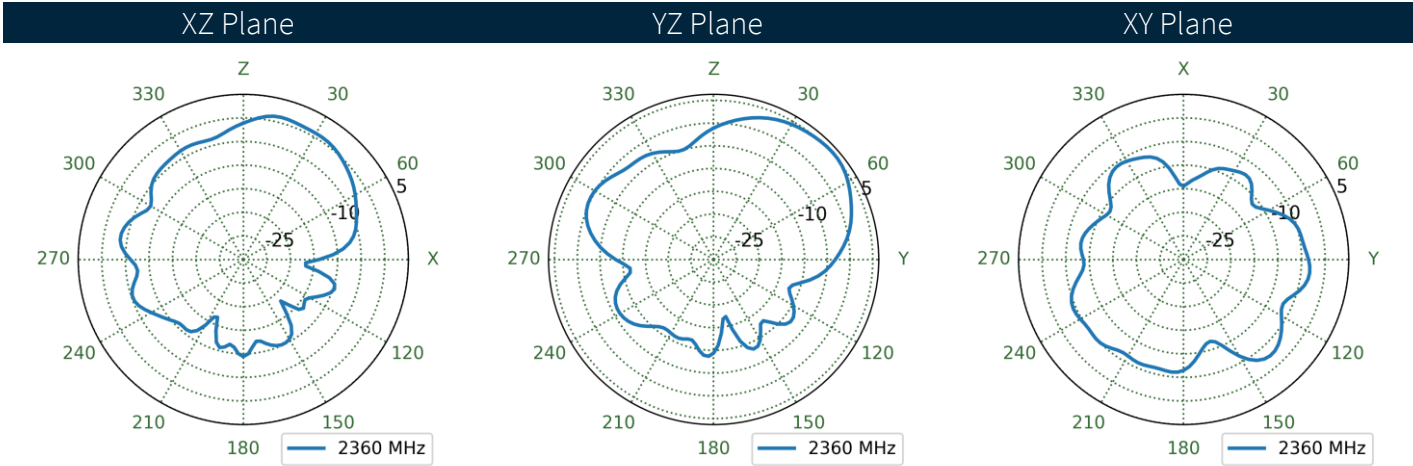
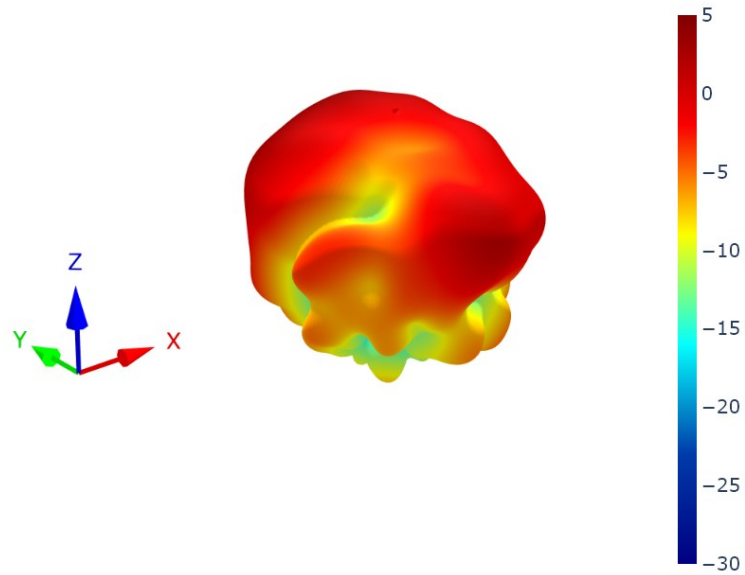

8.63 Cellular 4 Patterns at 2360 MHz

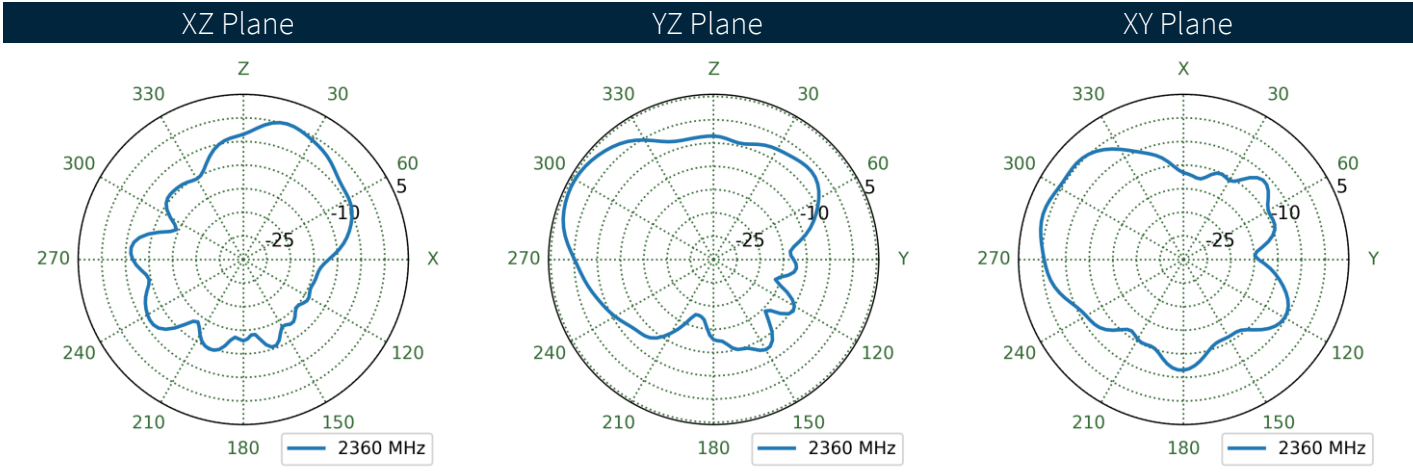
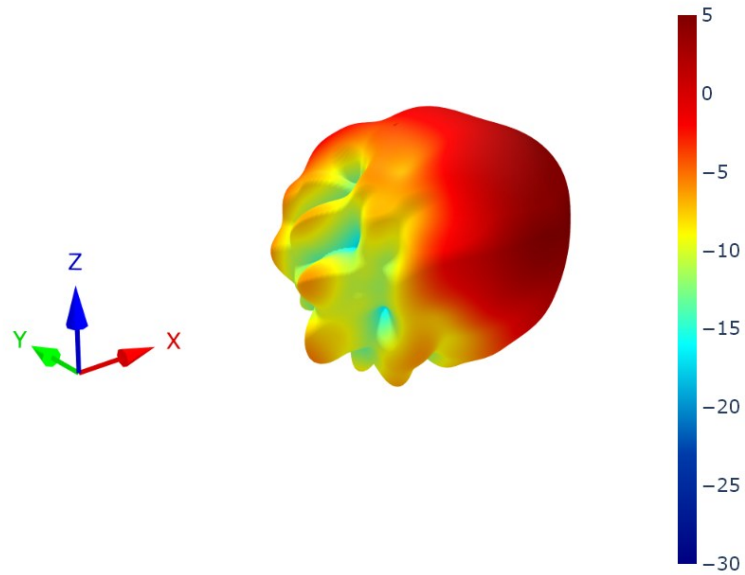

8.64 Cellular 5 Patterns at 2360 MHz

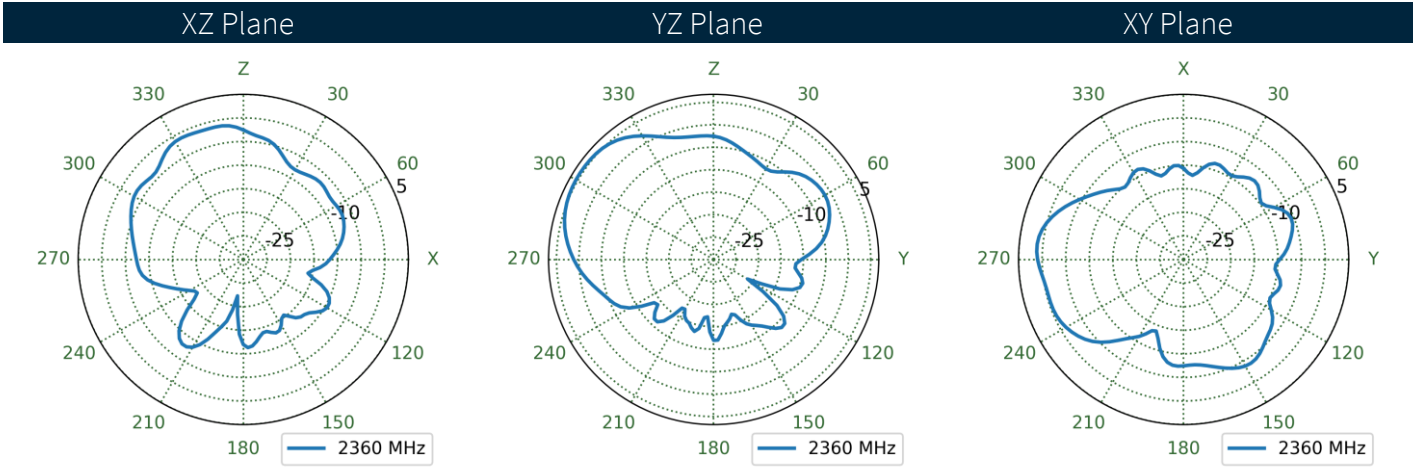
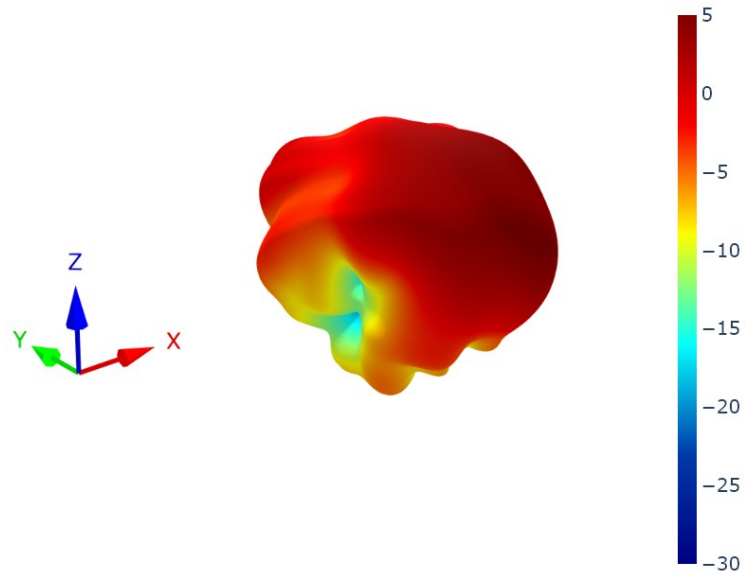

8.65 Cellular 6 Patterns at 2360 MHz

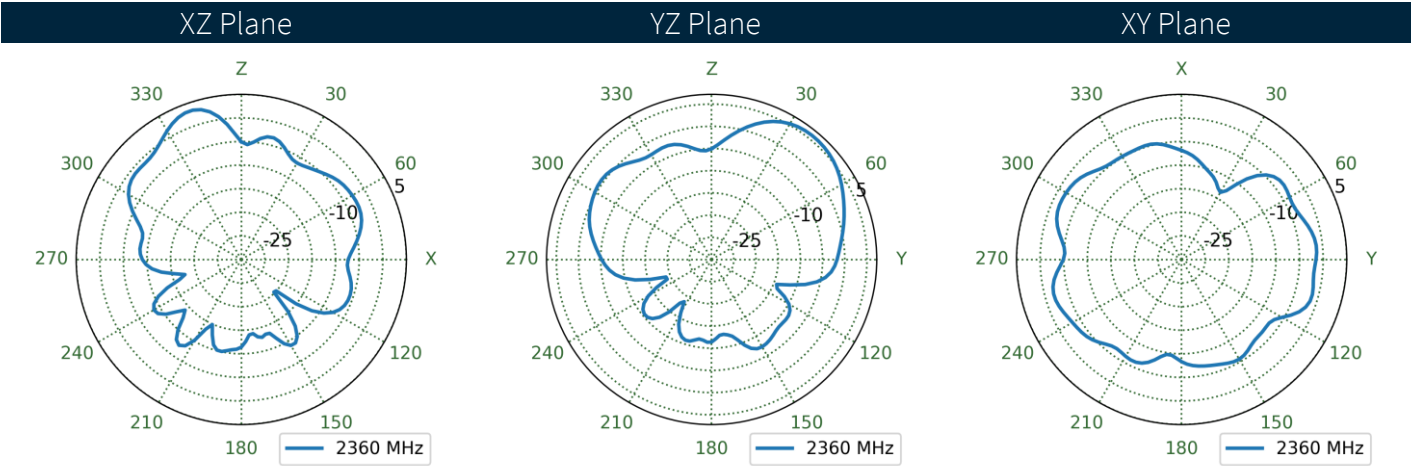
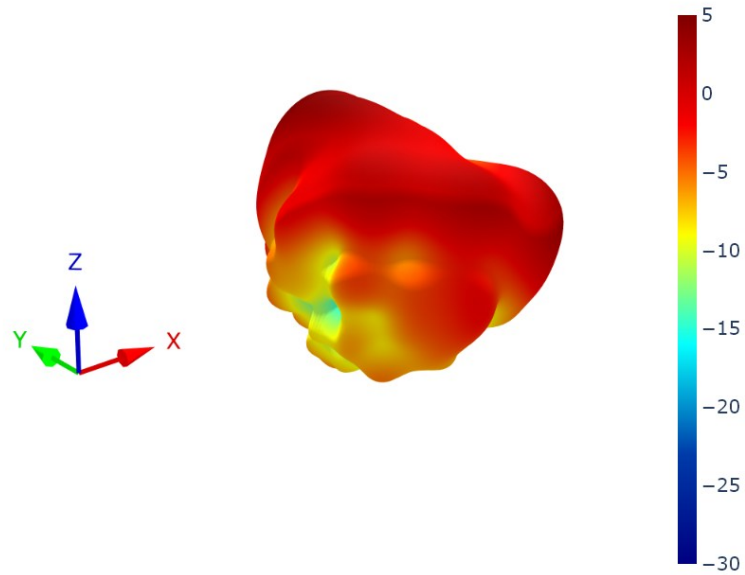

8.66 Cellular 7 Patterns at 2360 MHz

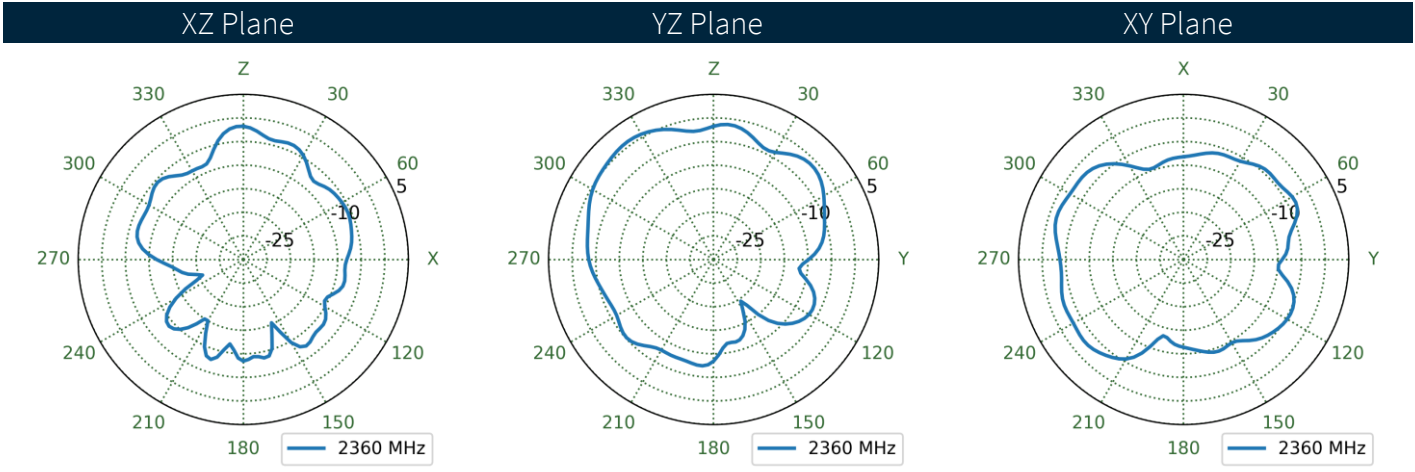
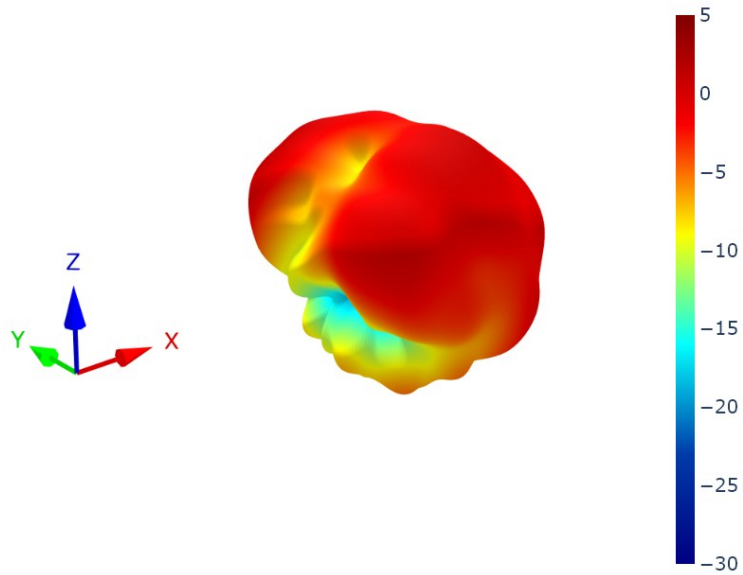

8.67 Cellular 8 Patterns at 2360 MHz

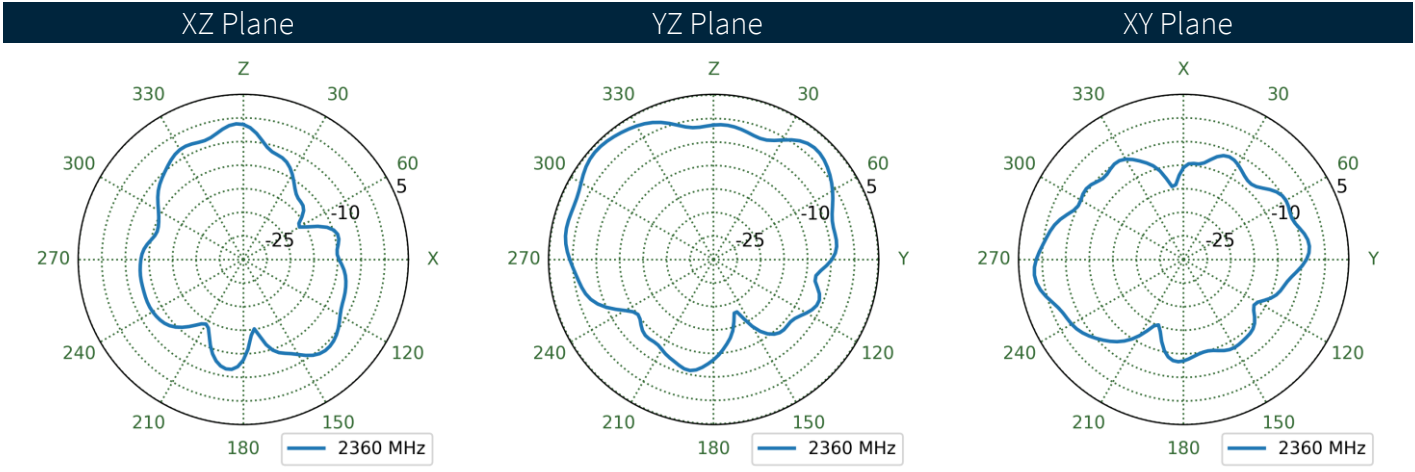
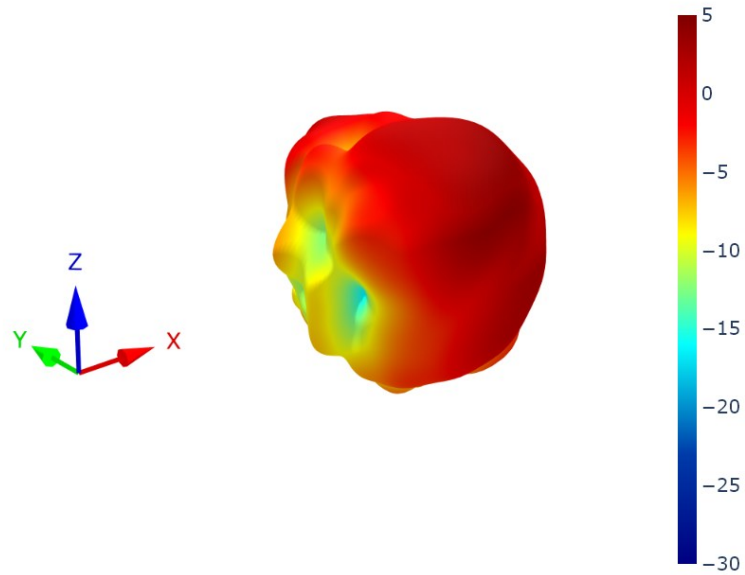

8.68 Cellular 1 Patterns at 2595 MHz

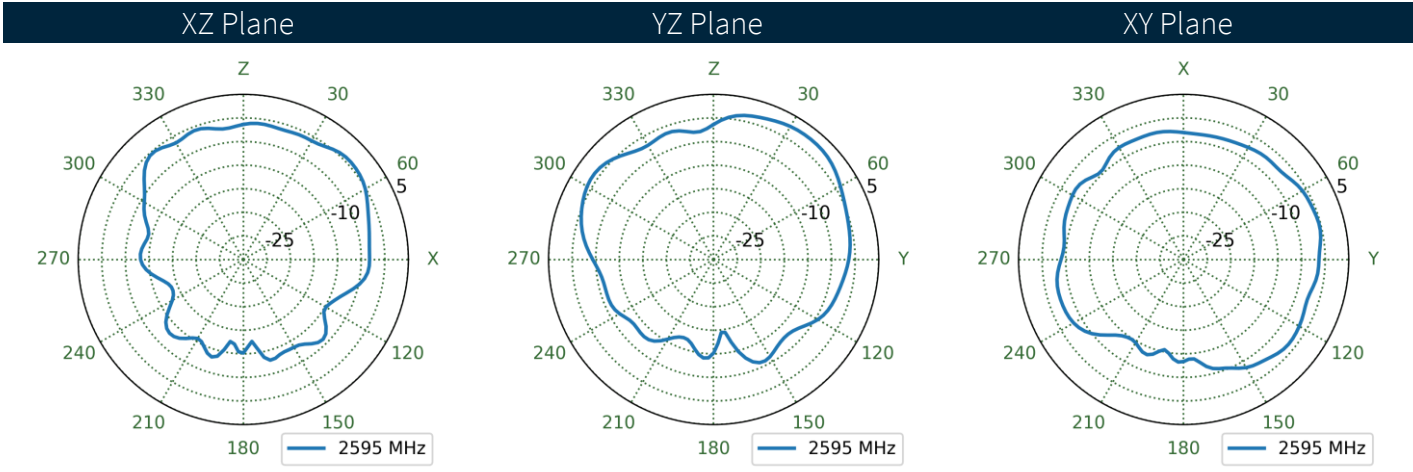
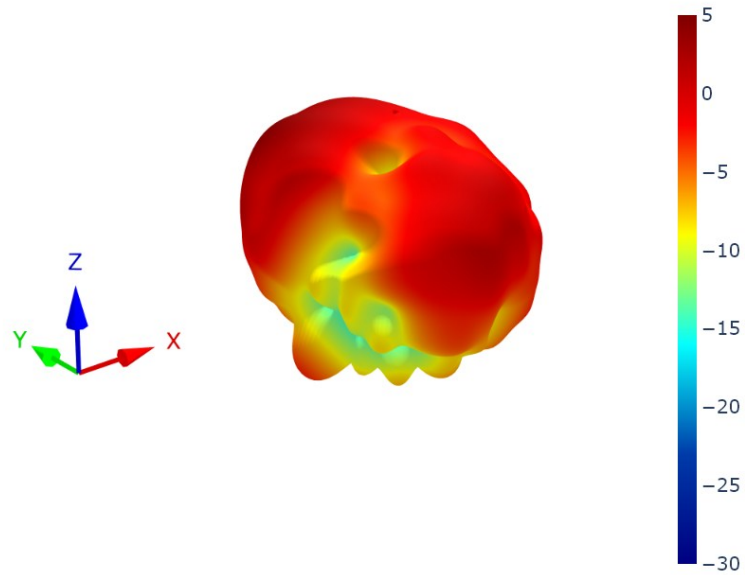

8.69 Cellular 2 Patterns at 2595 MHz

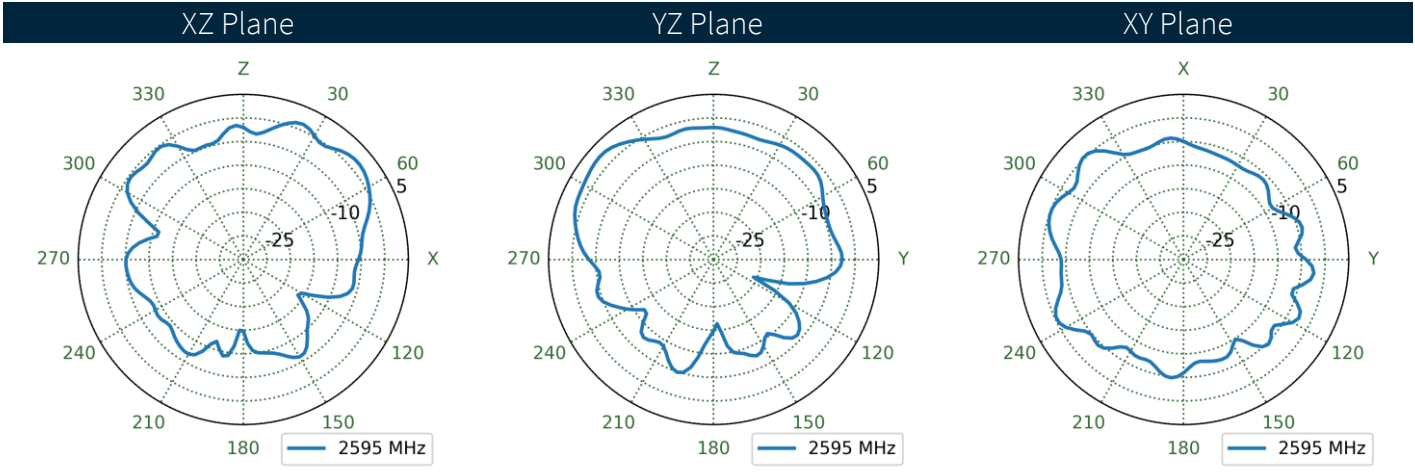
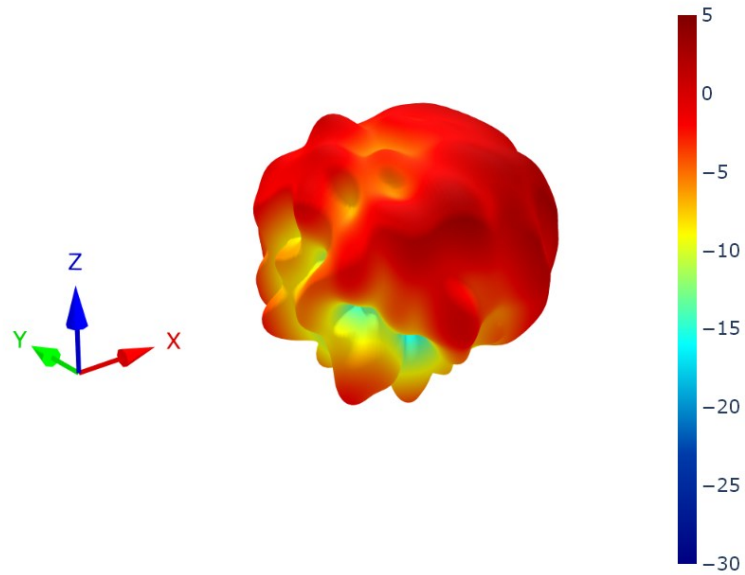

8.70 Cellular 3 Patterns at 2595 MHz

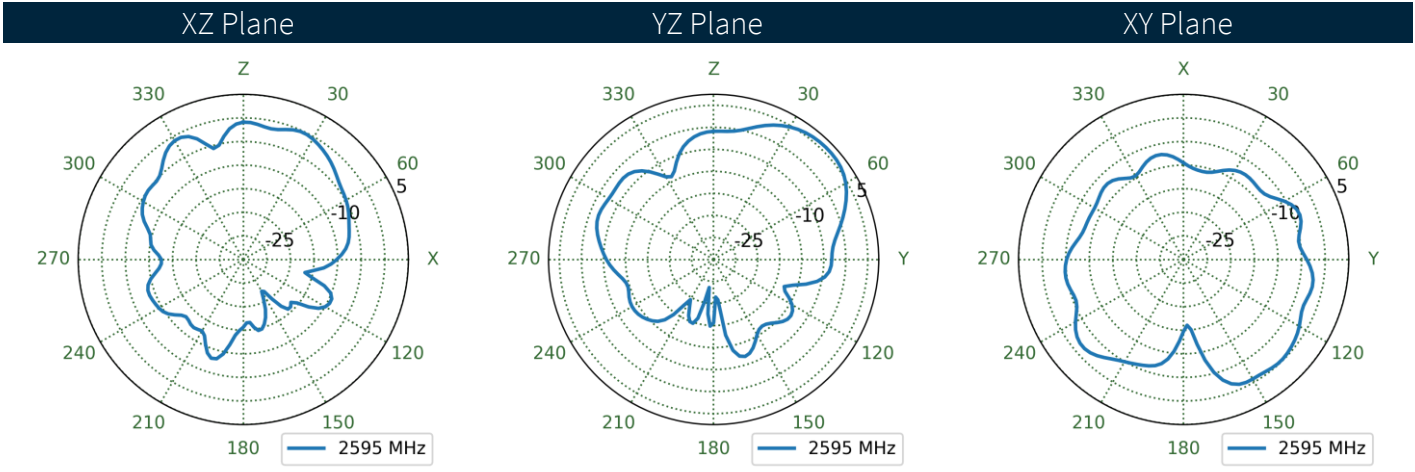
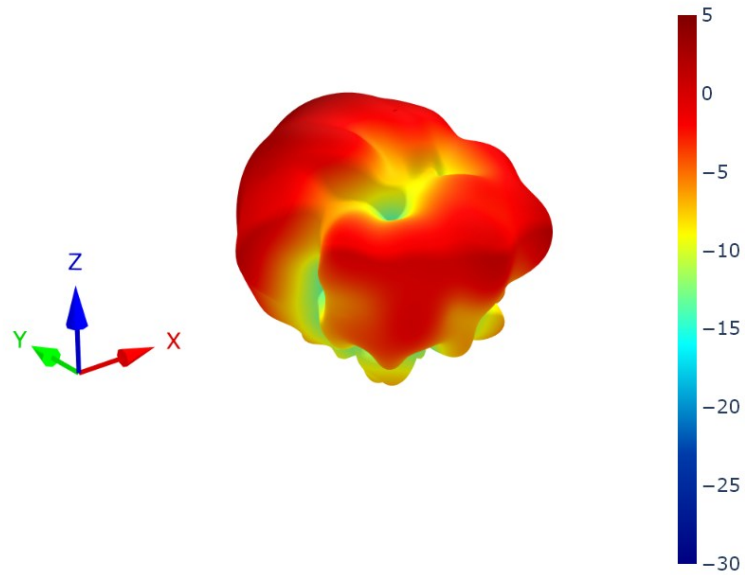

8.71 Cellular 4 Patterns at 2595 MHz

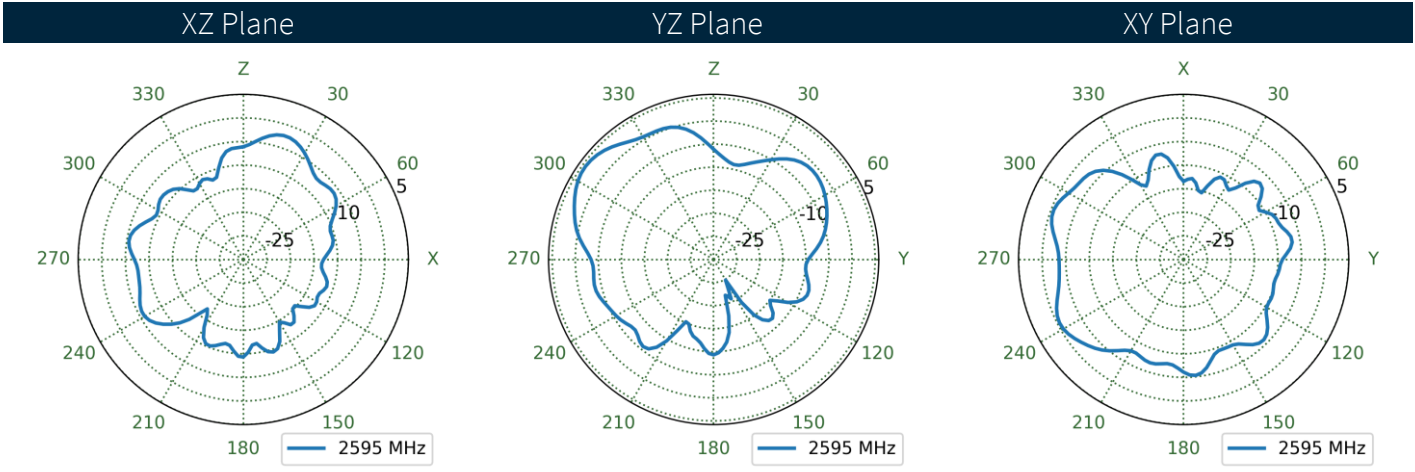
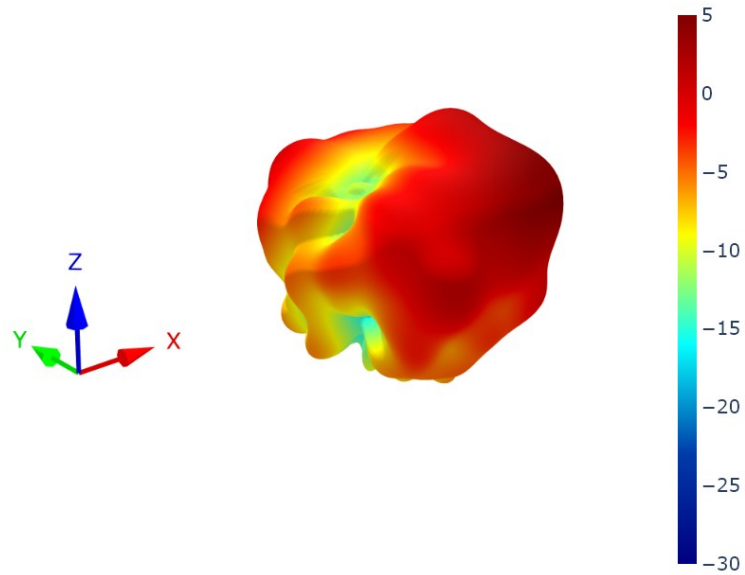

8.72 Cellular 5 Patterns at 2595 MHz

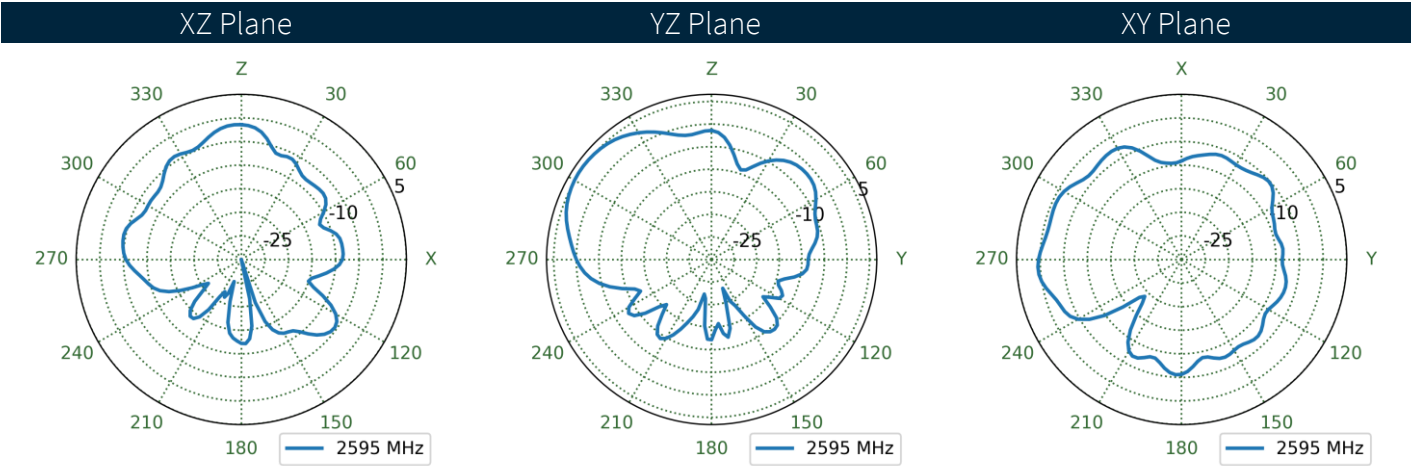
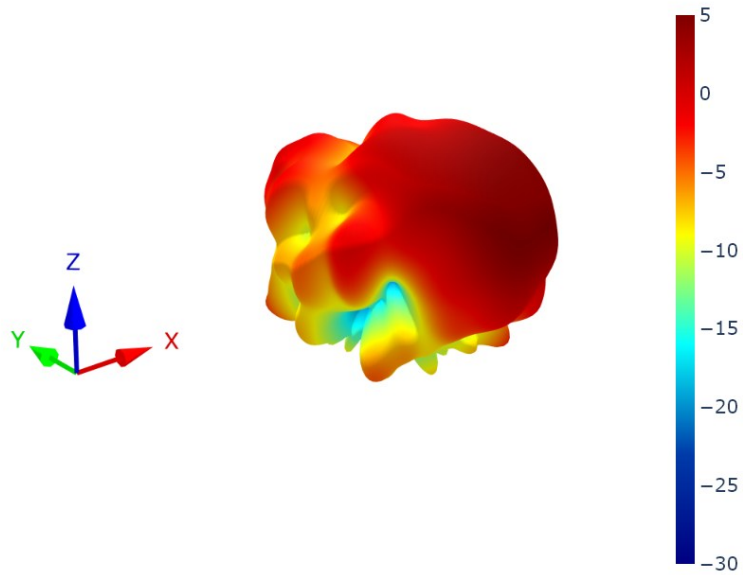

8.73 Cellular 6 Patterns at 2595 MHz

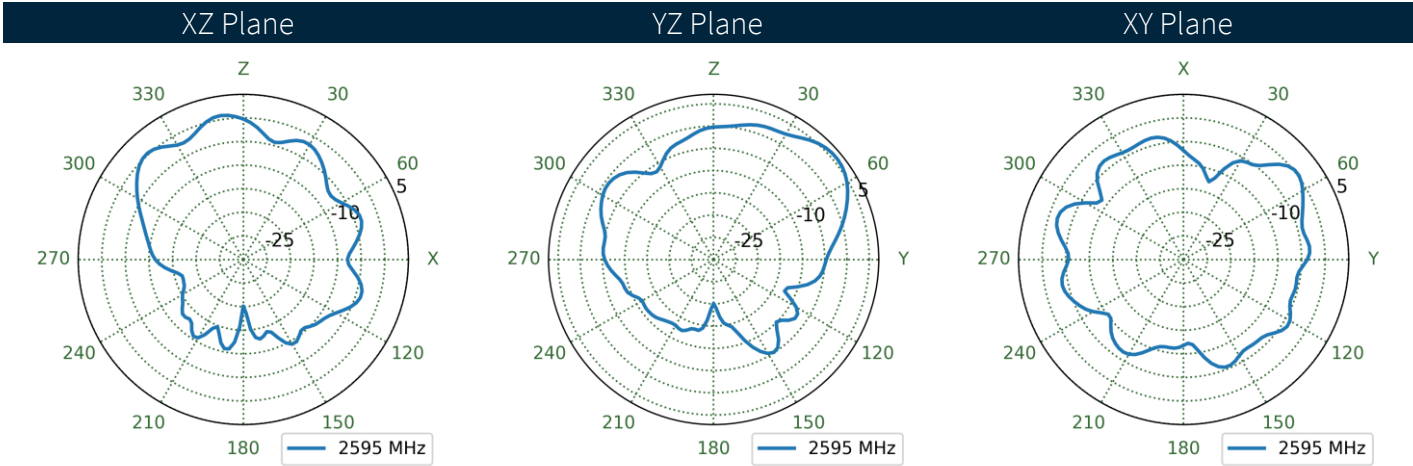
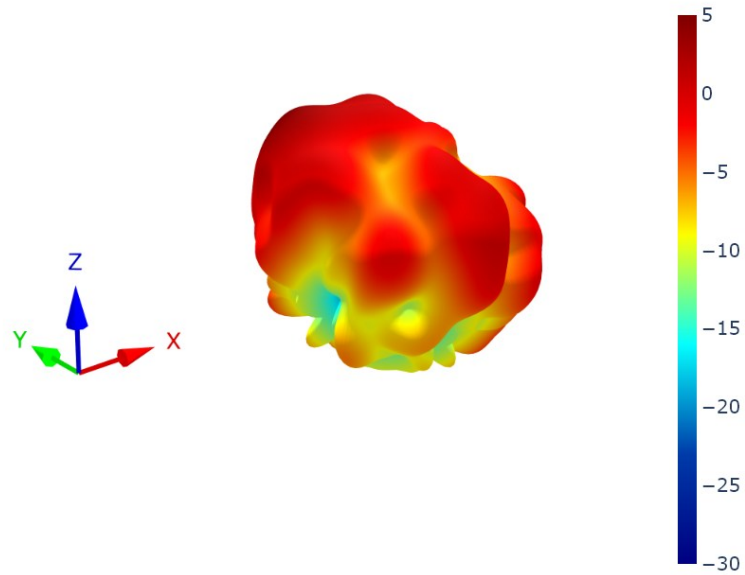

8.74 Cellular 7 Patterns at 2595 MHz

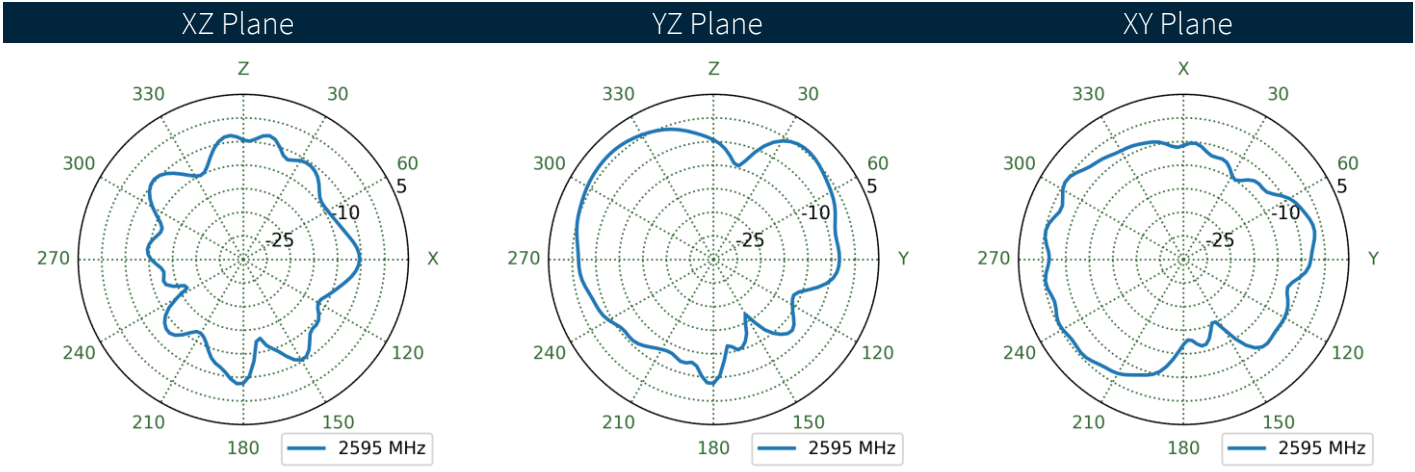
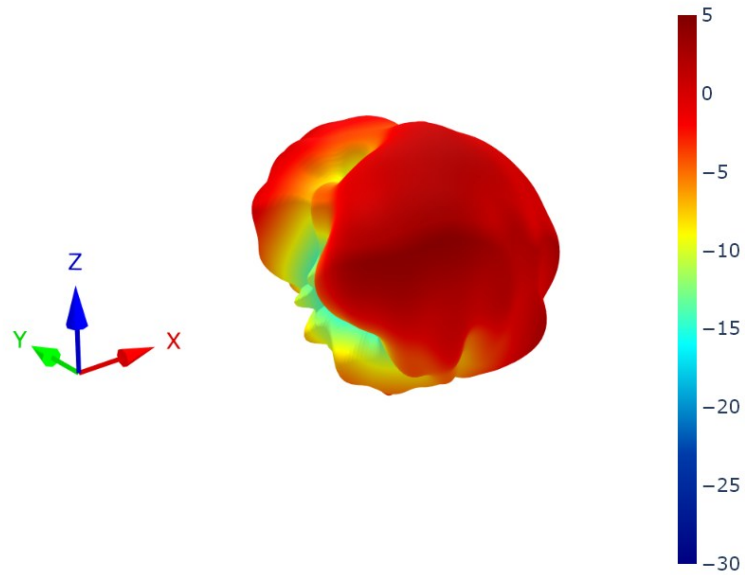

8.75 Cellular 8 Patterns at 2595 MHz

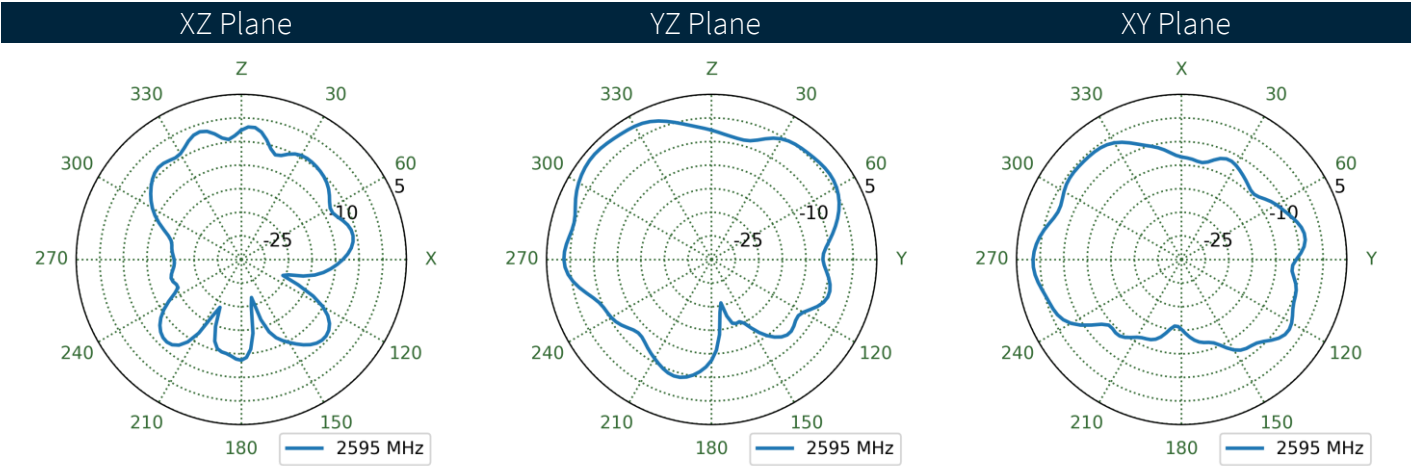
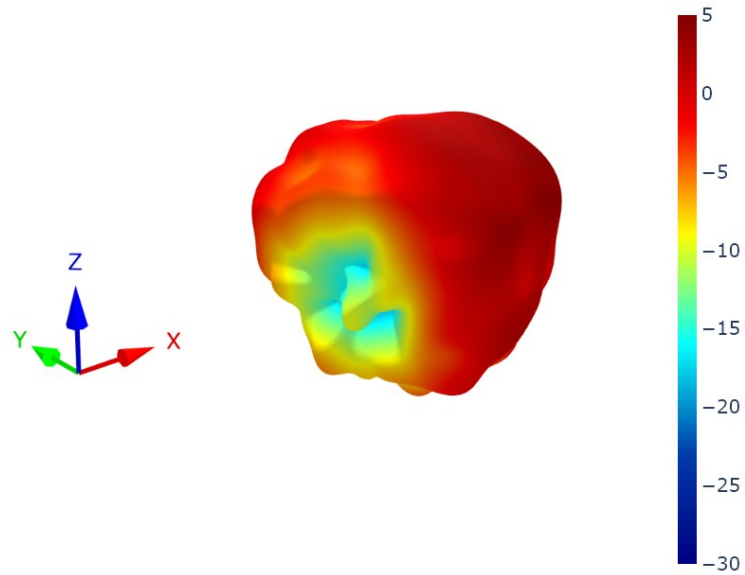

8.76 Cellular 1 Patterns at 3550 MHz

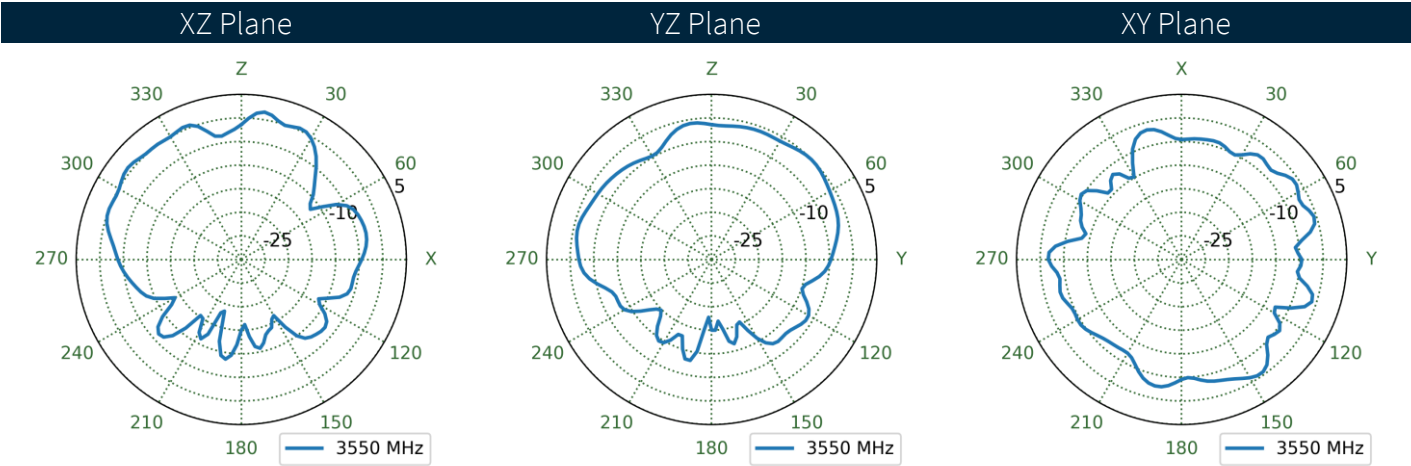
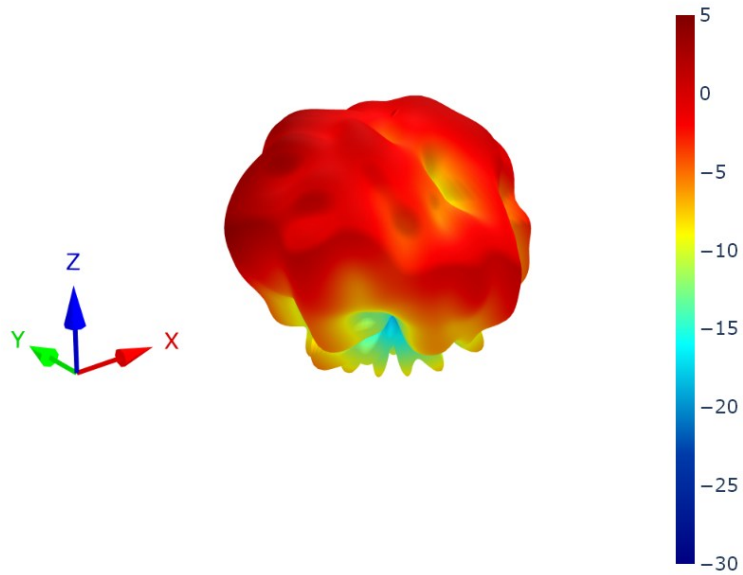

8.77 Cellular 2 Patterns at 3550 MHz

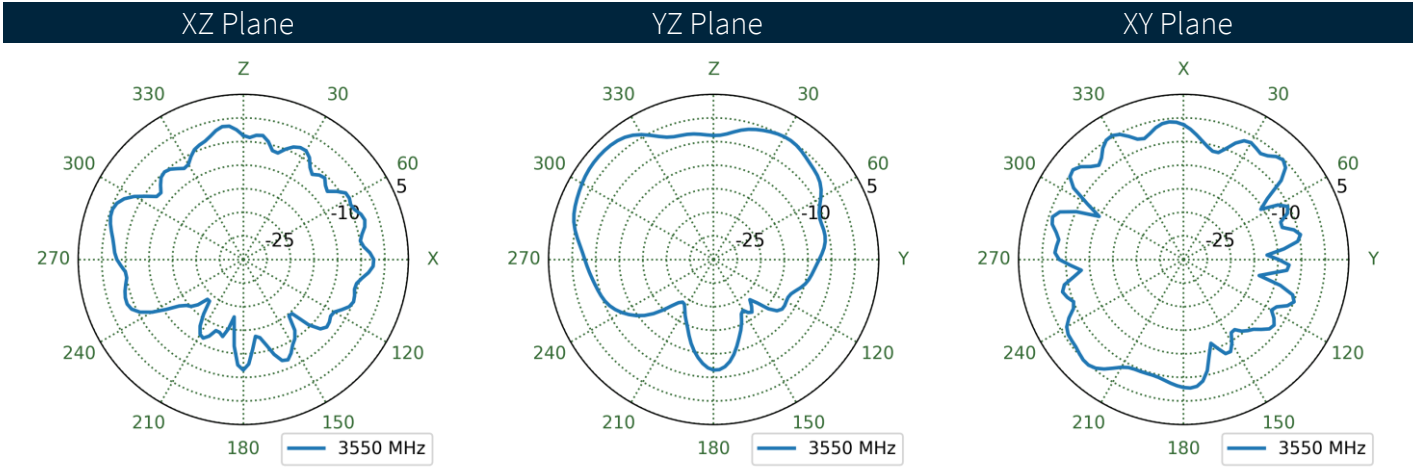
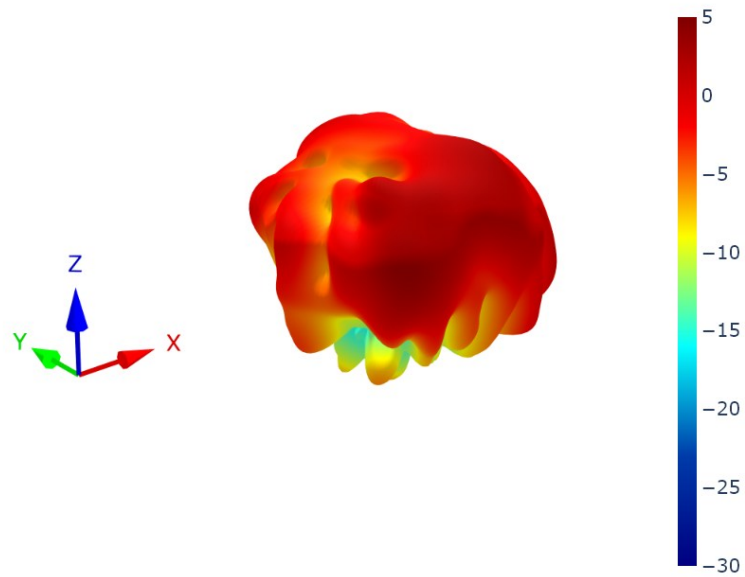

8.78 Cellular 3 Patterns at 3550 MHz

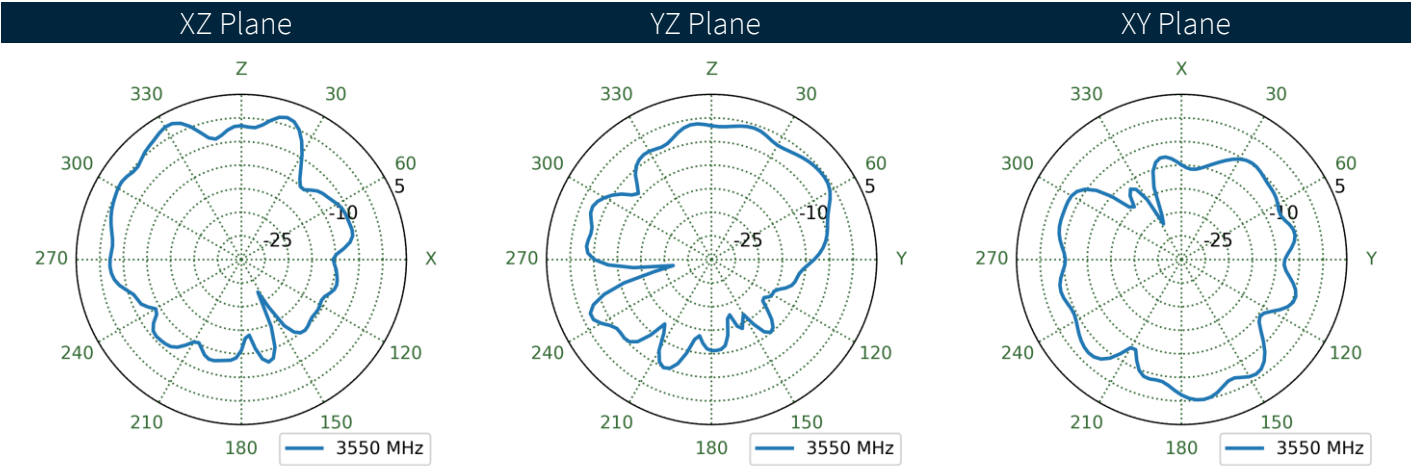
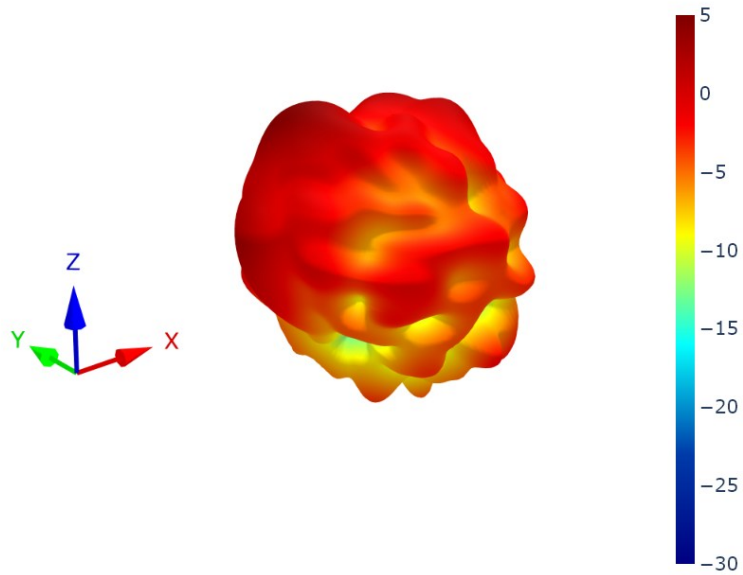

8.79 Cellular 4 Patterns at 3550 MHz

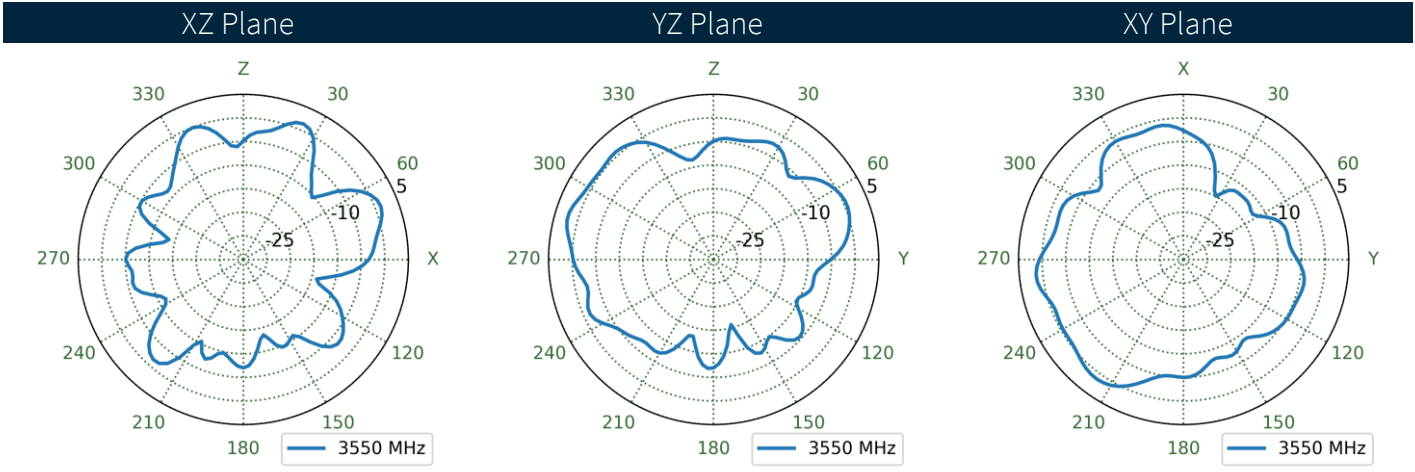
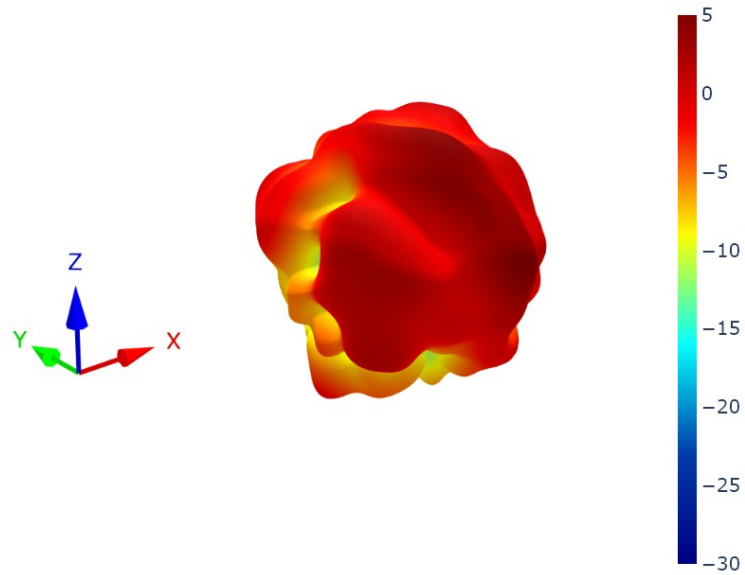

8.80 Cellular 5 Patterns at 3550 MHz

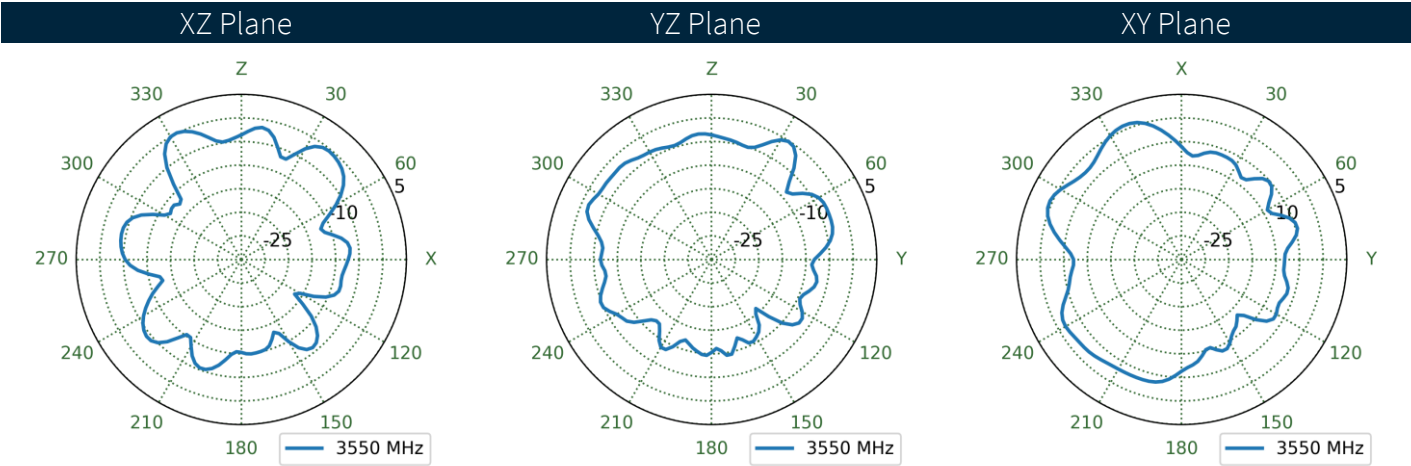
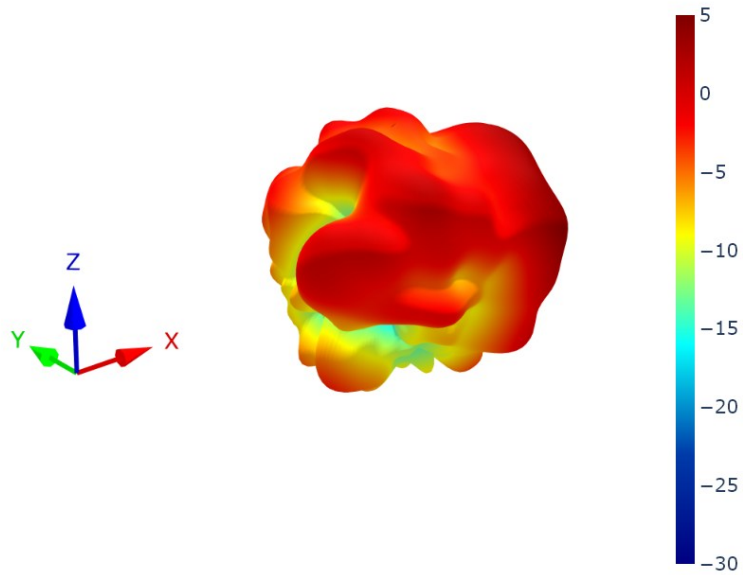

8.81 Cellular 6 Patterns at 3550 MHz

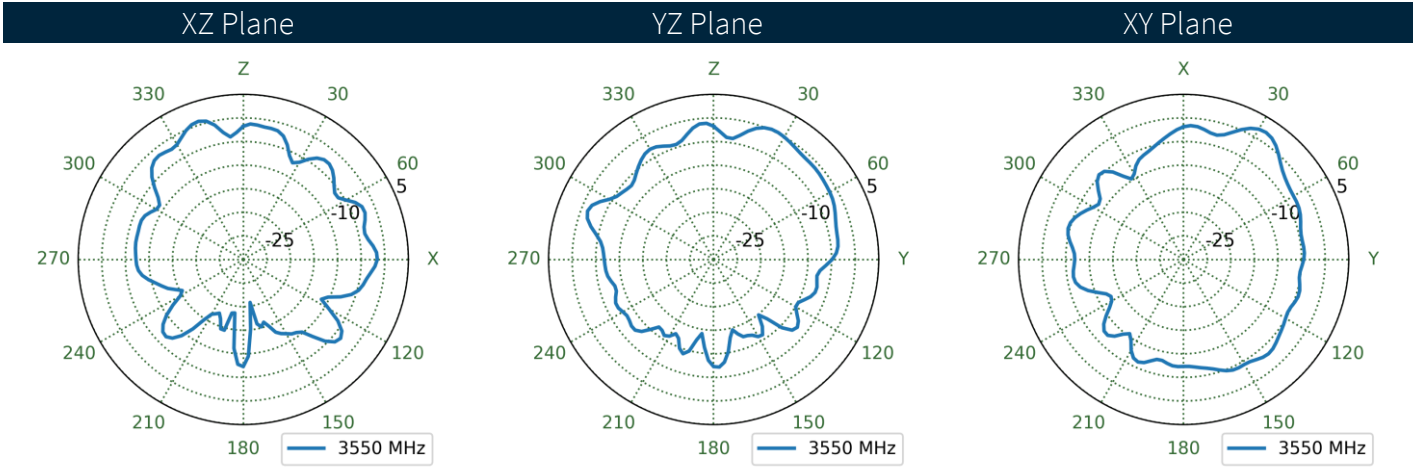
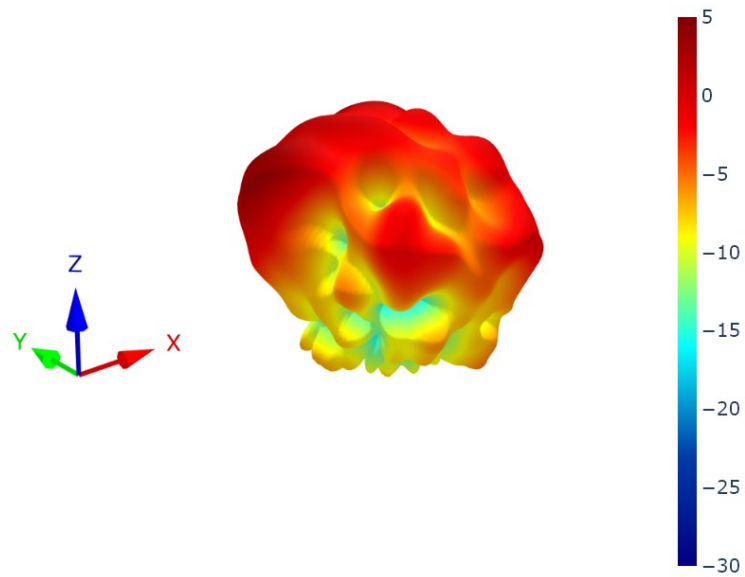

8.82 Cellular 7 Patterns at 3550 MHz

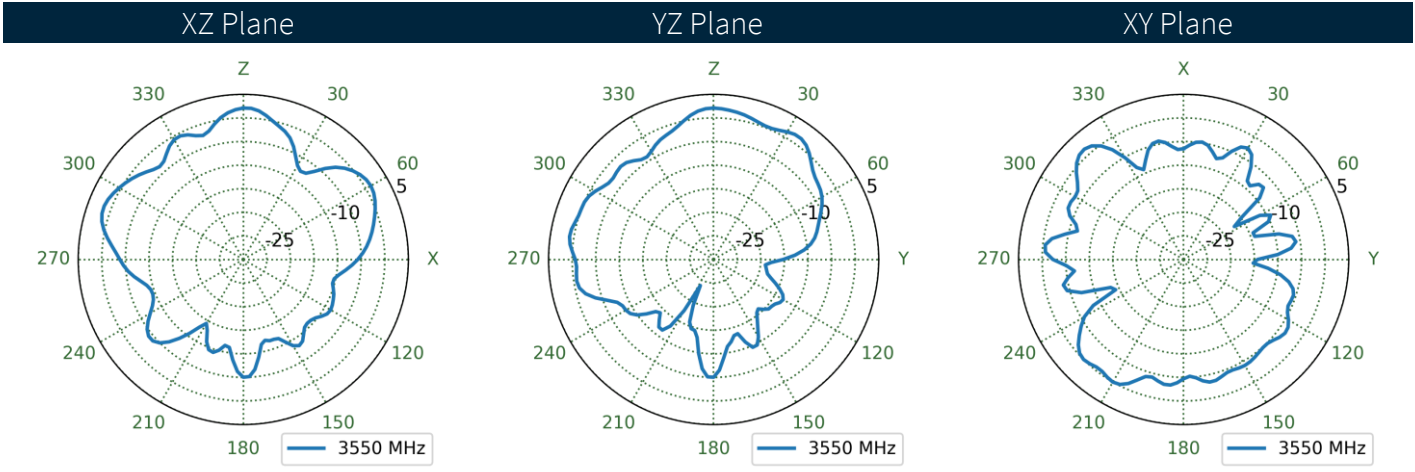
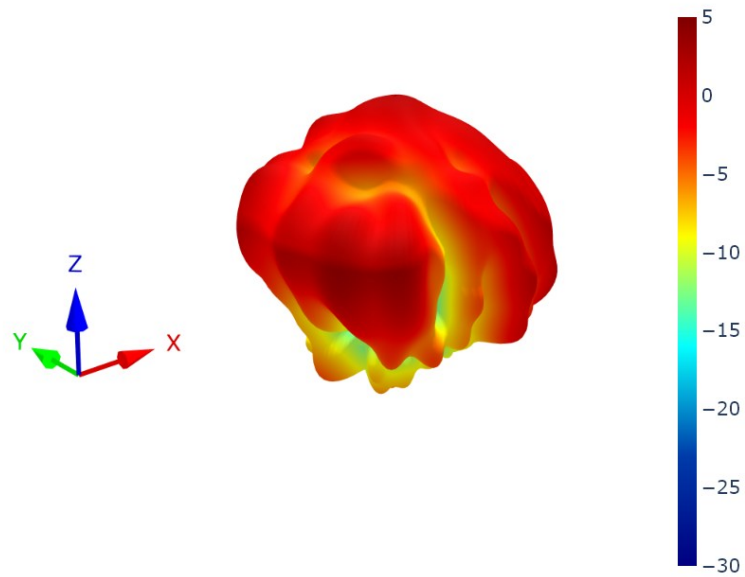

8.83 Cellular 8 Patterns at 3550 MHz

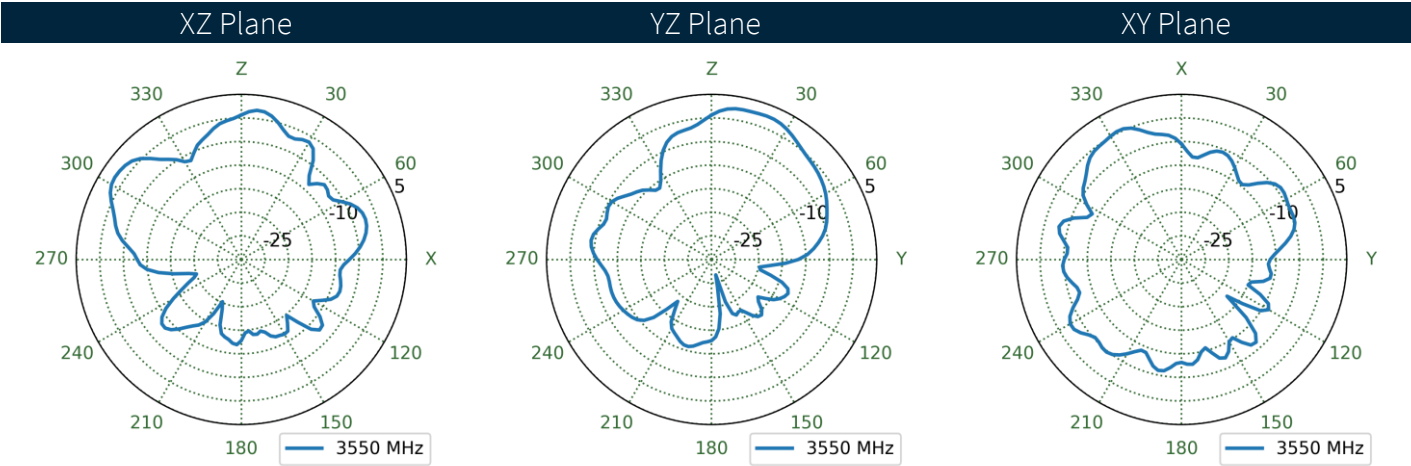
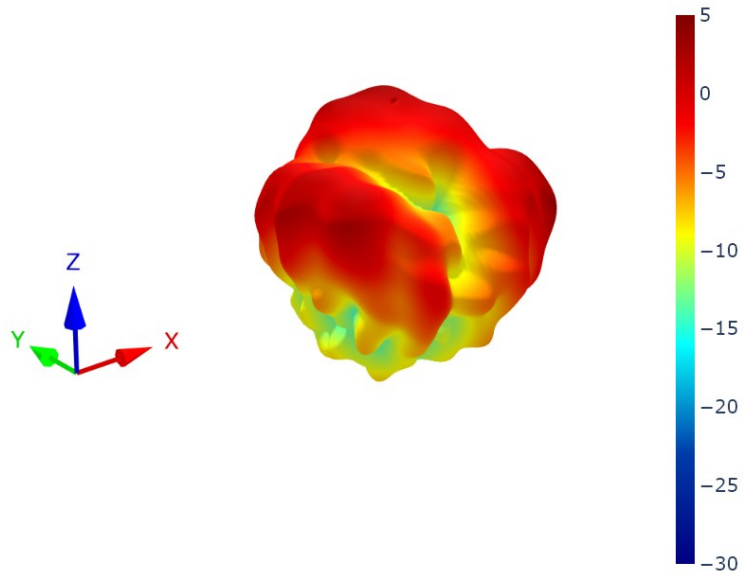

8.84 Cellular 1 Patterns at 4600 MHz

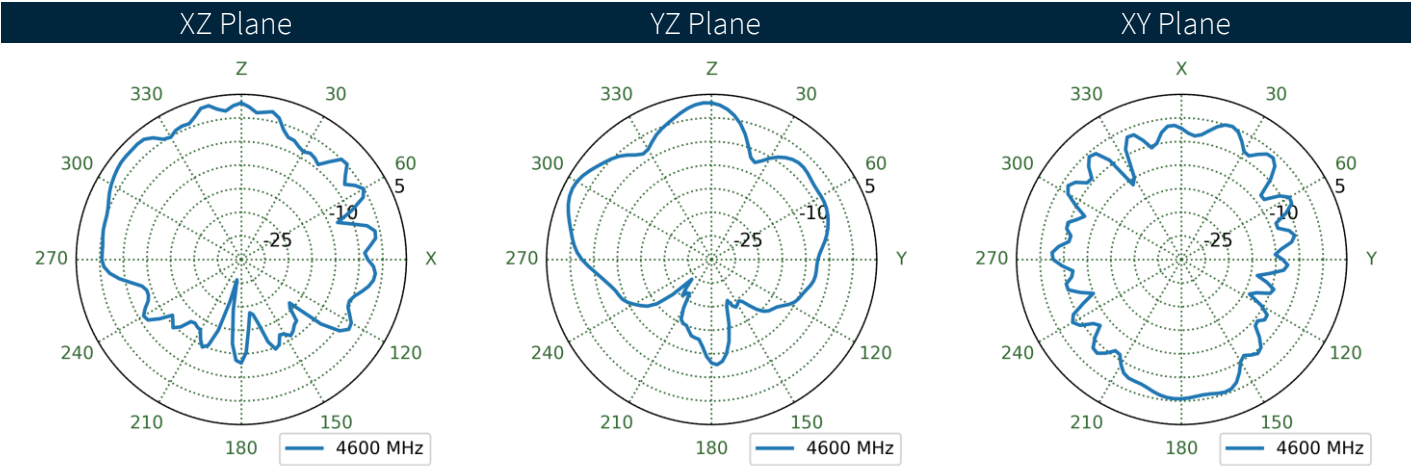
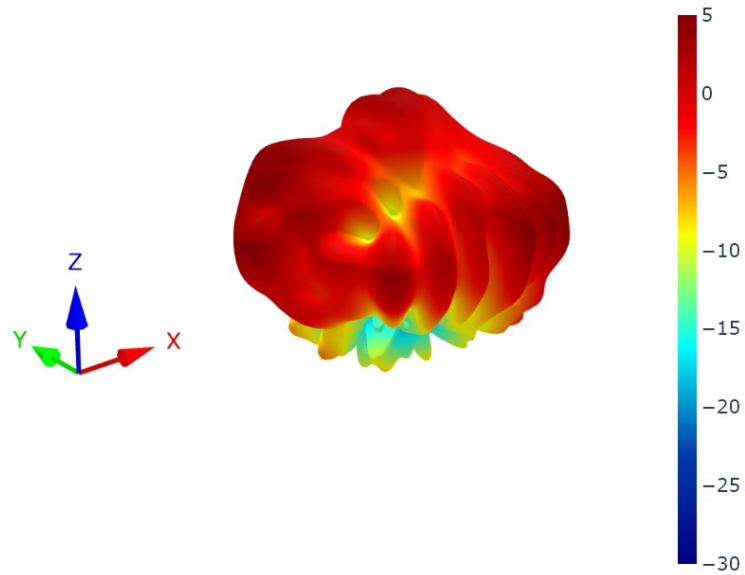

8.85 Cellular 2 Patterns at 4600 MHz

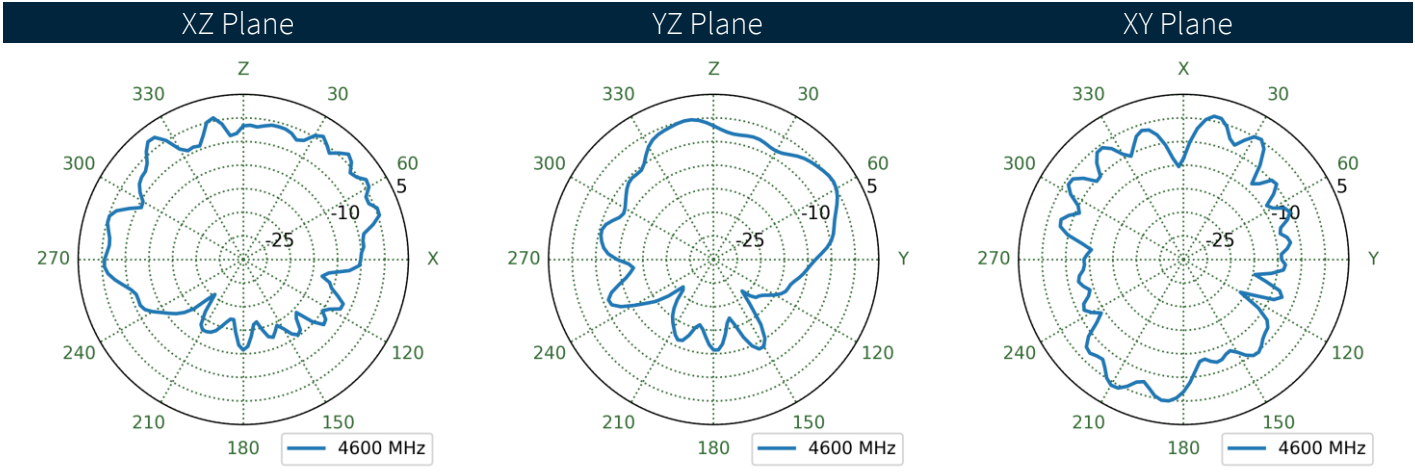
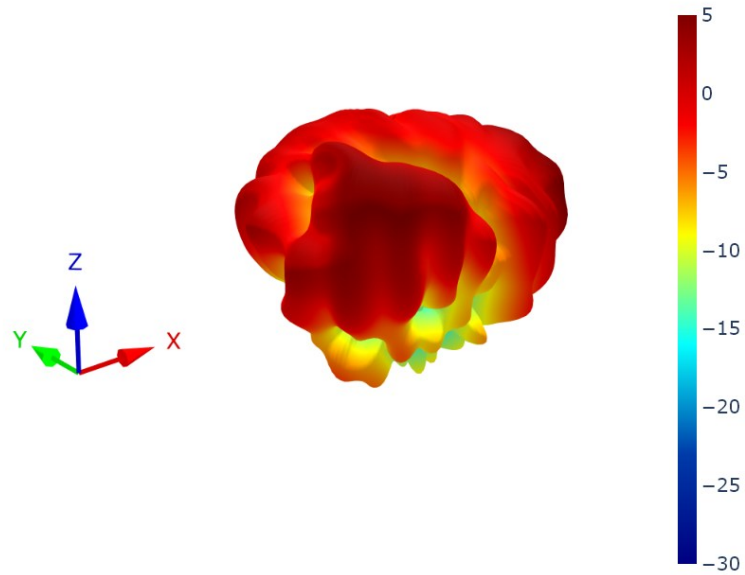

8.86 Cellular 3 Patterns at 4600 MHz

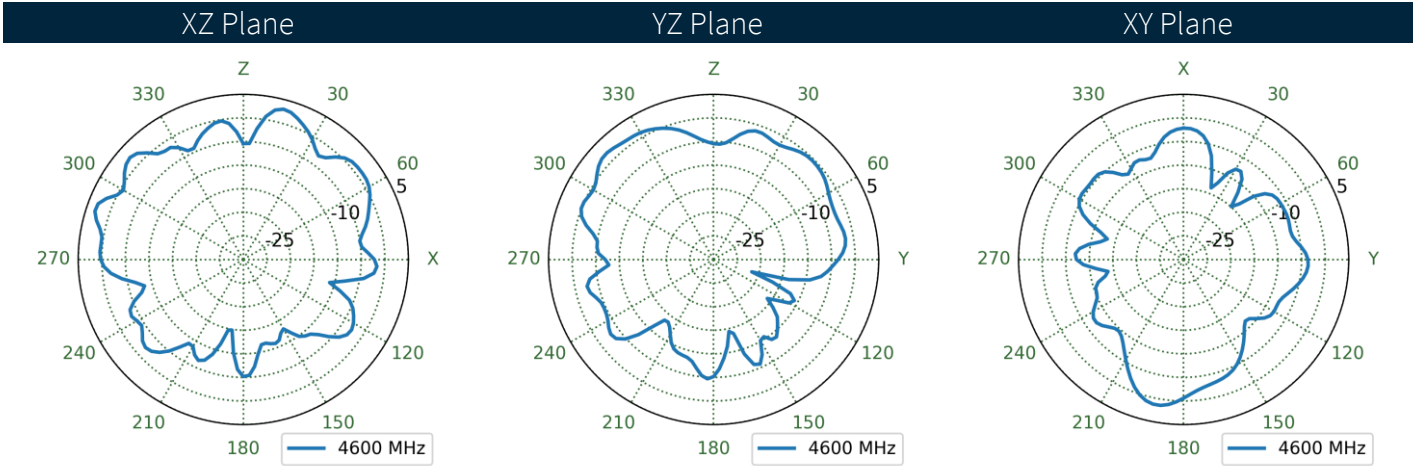
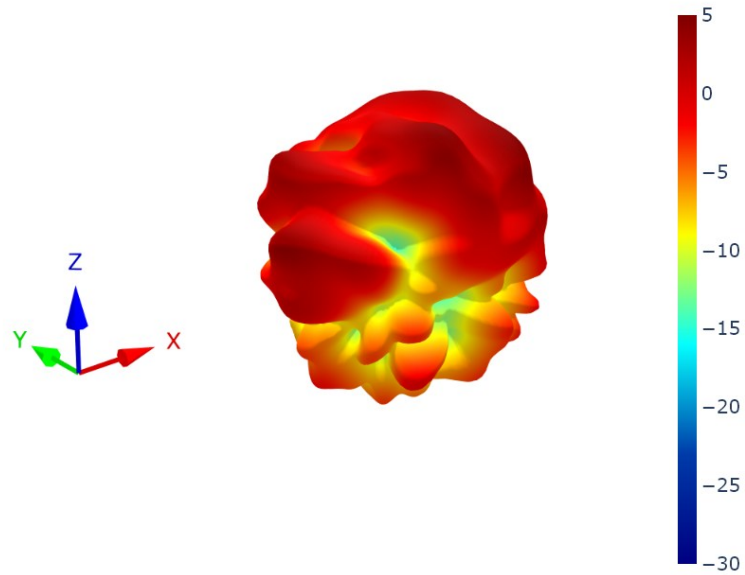

8.87 Cellular 4 Patterns at 4600 MHz

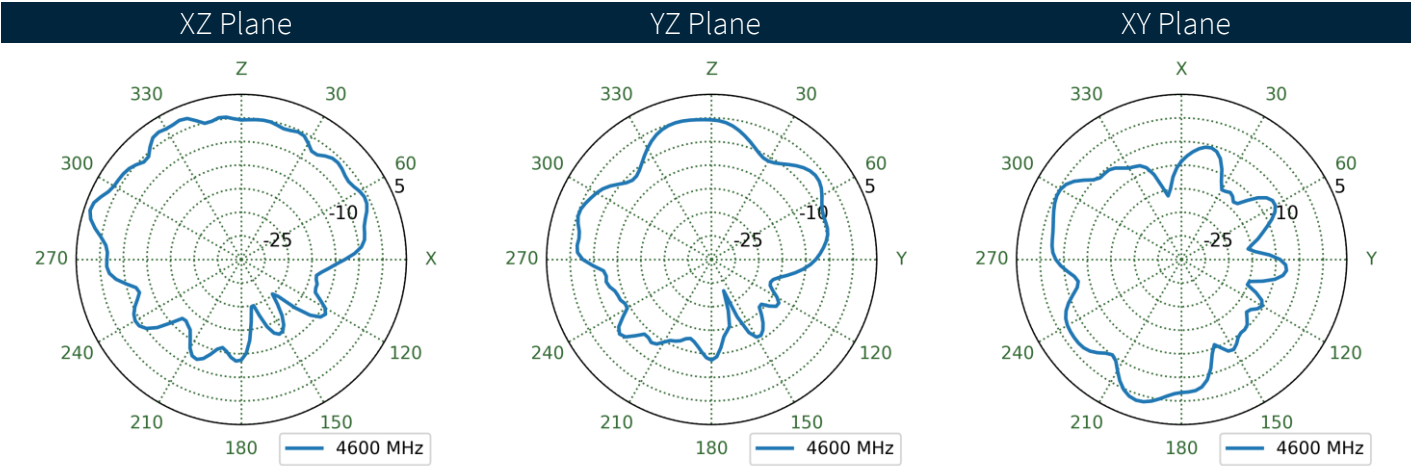
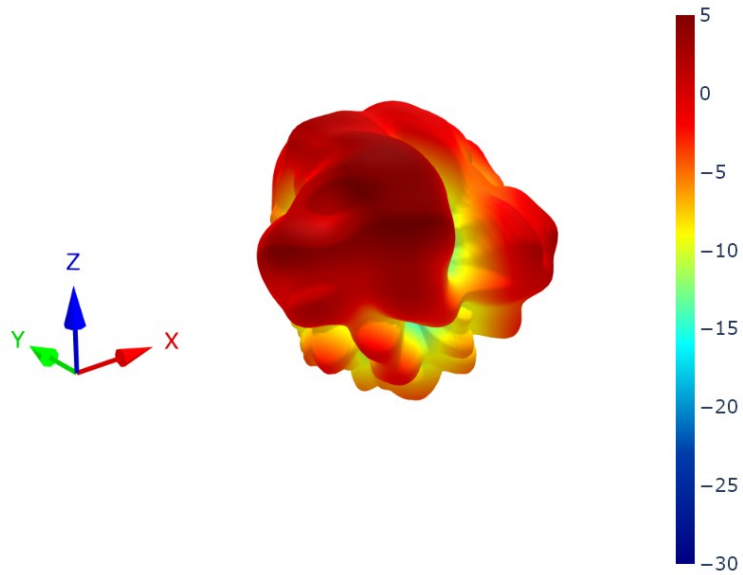

8.88 Cellular 5 Patterns at 4600 MHz

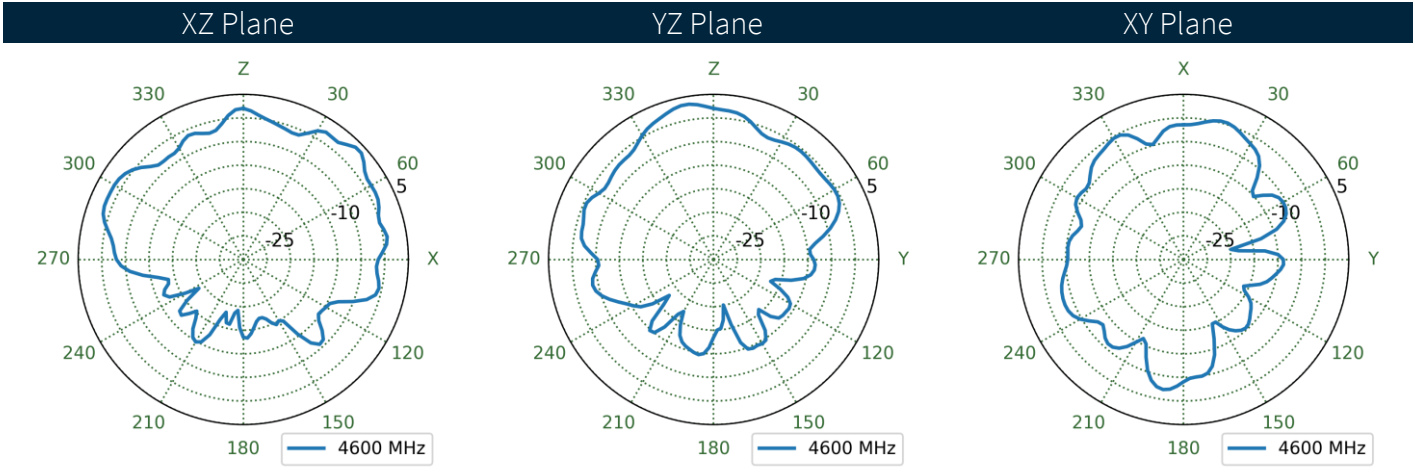
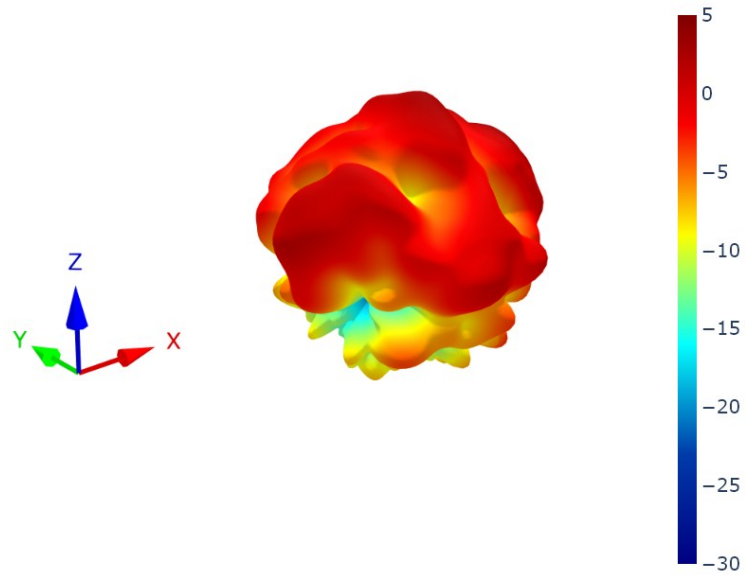

8.89 Cellular 6 Patterns at 4600 MHz

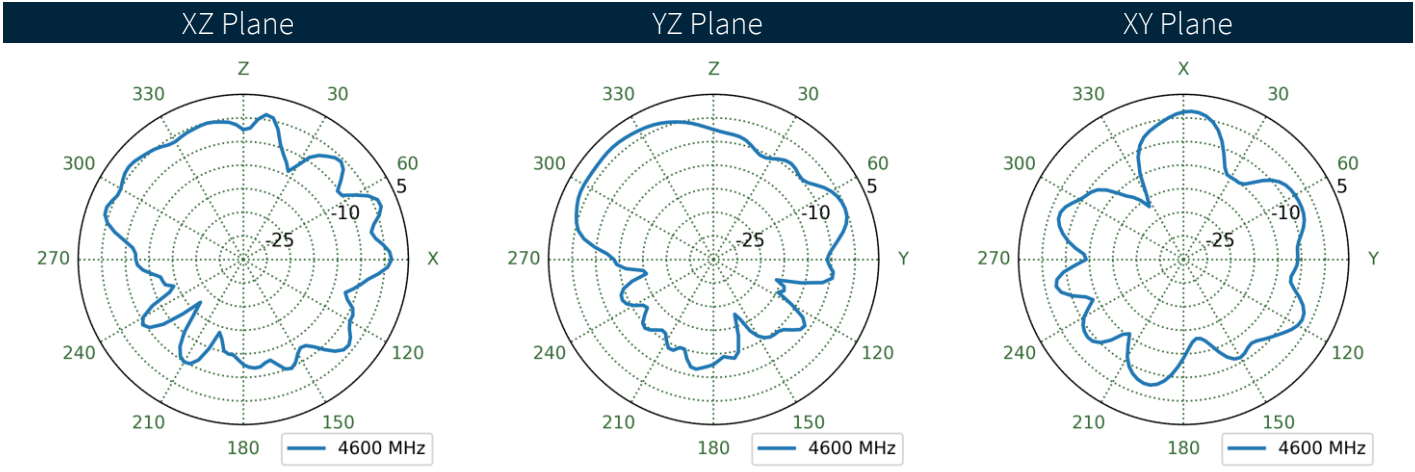
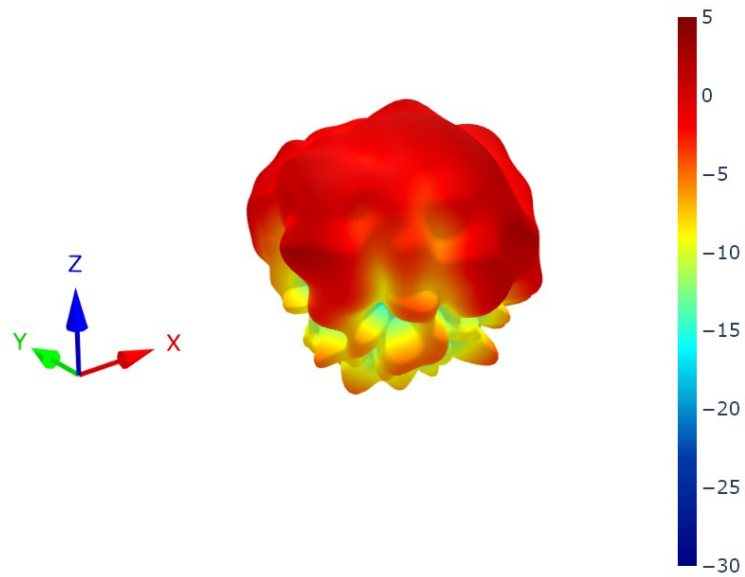

8.90 Cellular 7 Patterns at 4600 MHz

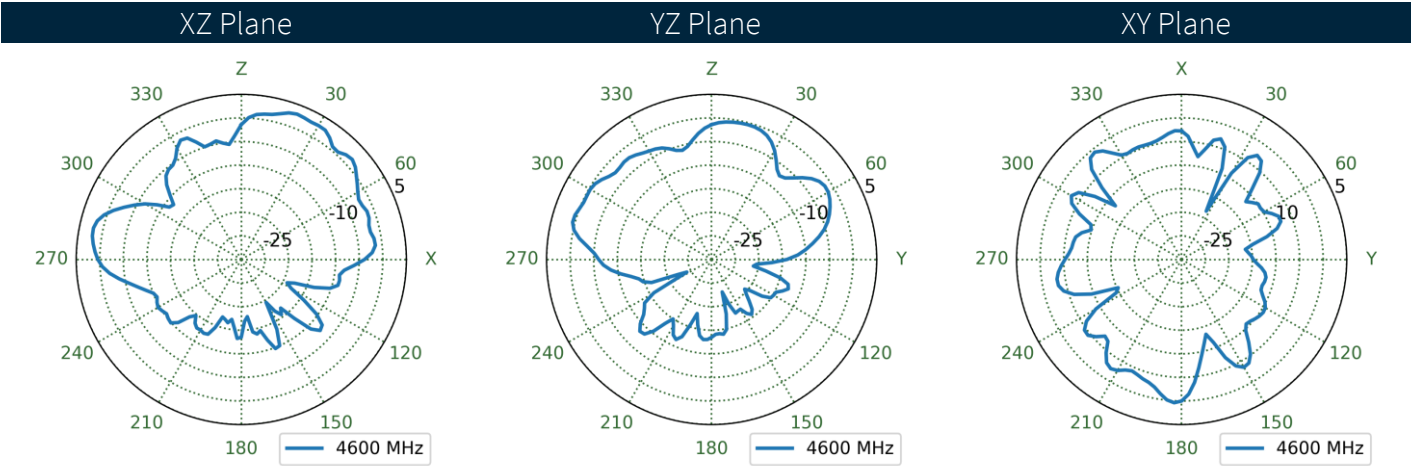
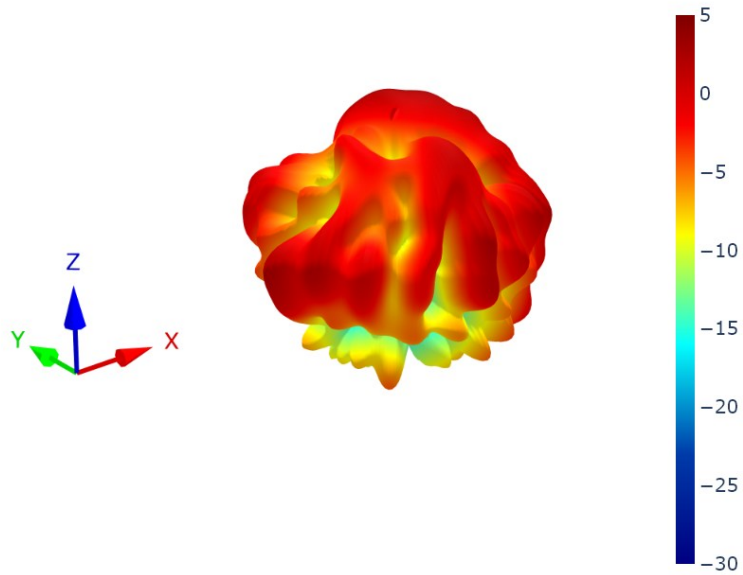

8.91 Cellular 8 Patterns at 4600 MHz

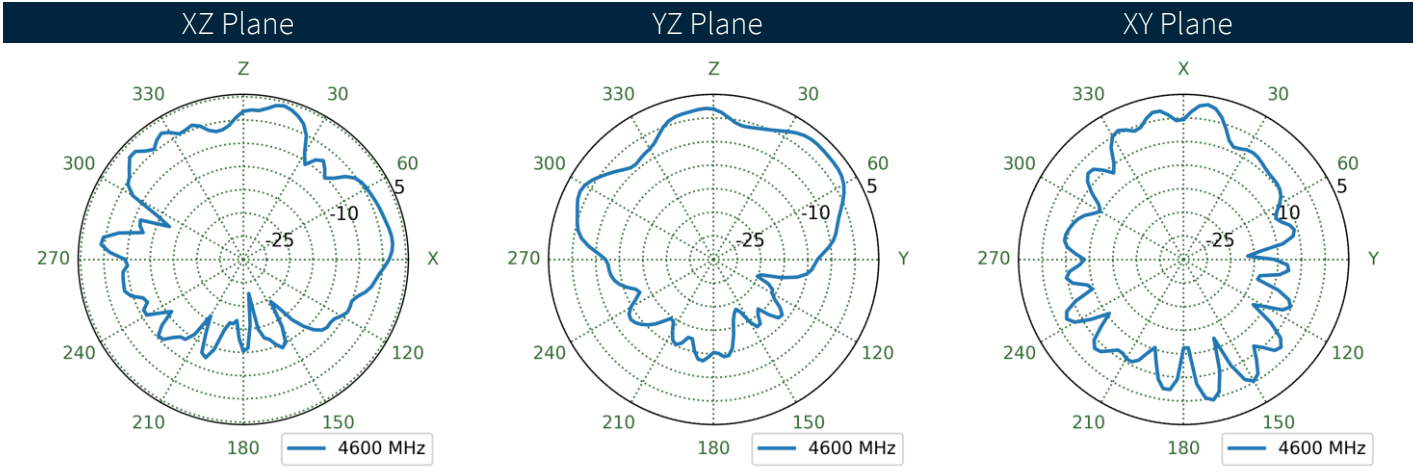
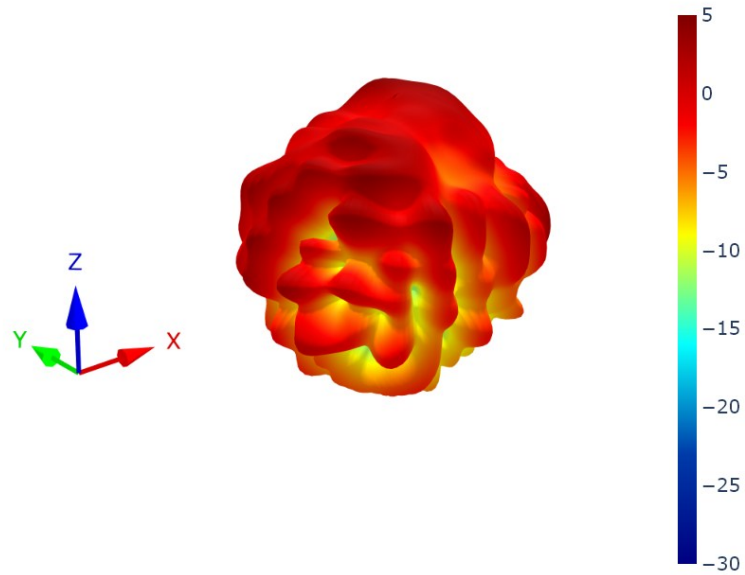

8.92 Cellular 1 Patterns at 4800 MHz

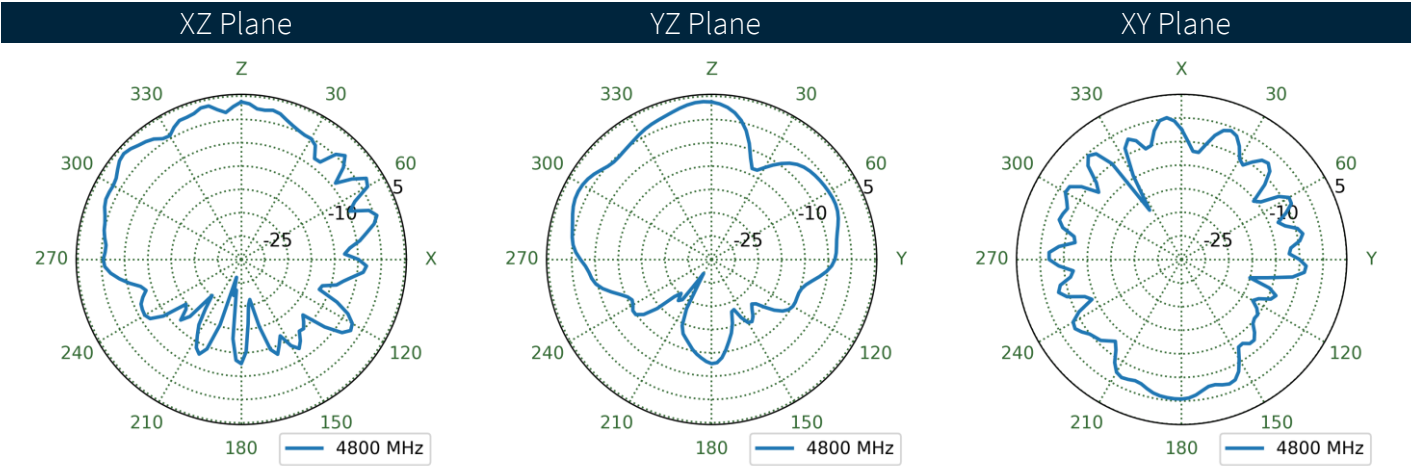
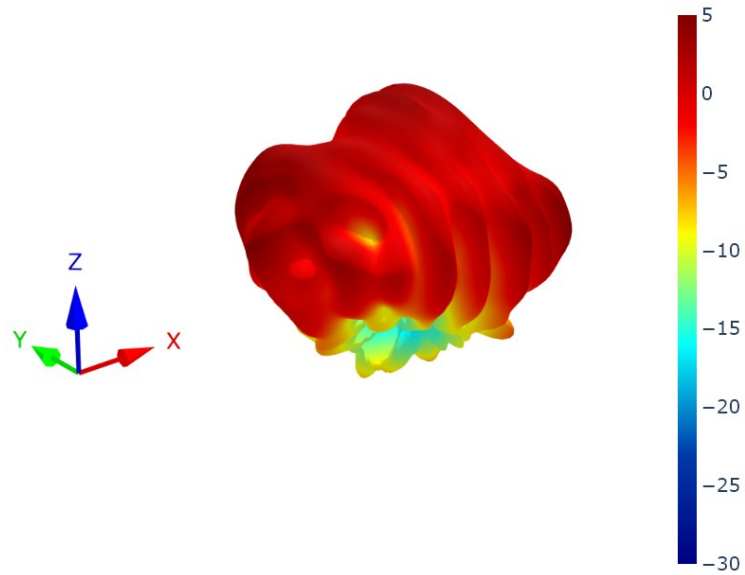

8.93 Cellular 2 Patterns at 4800 MHz

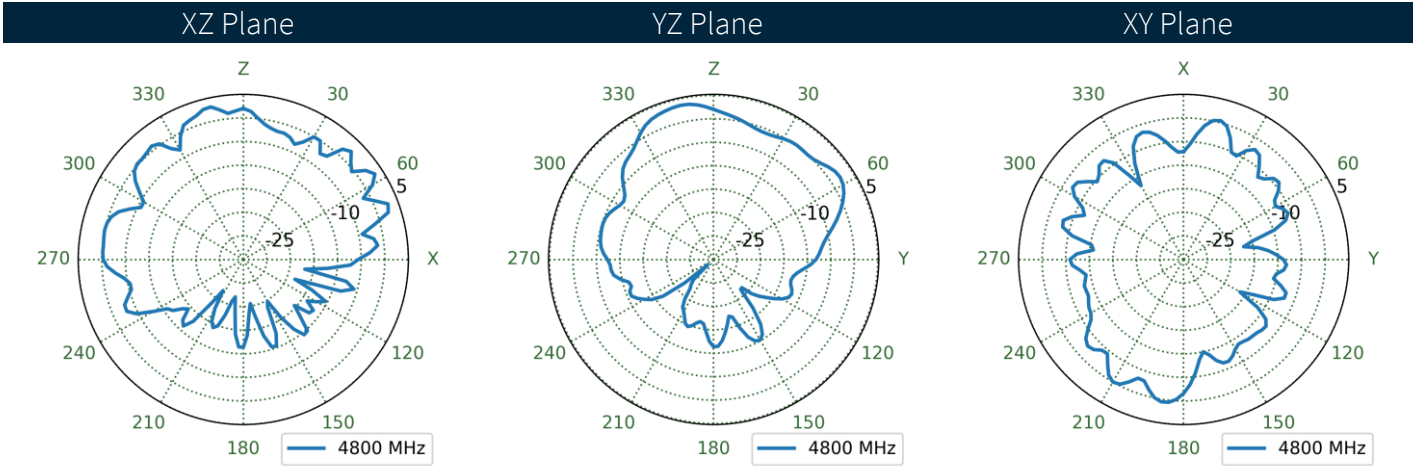
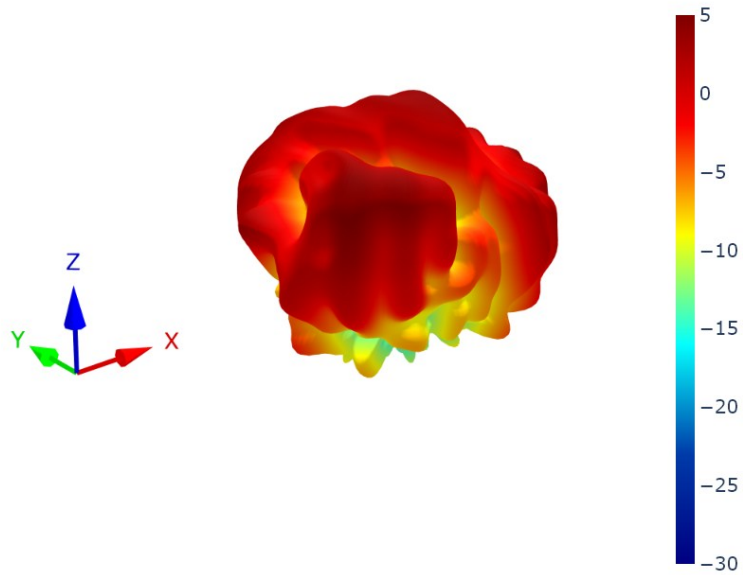

8.94 Cellular 3 Patterns at 4800 MHz

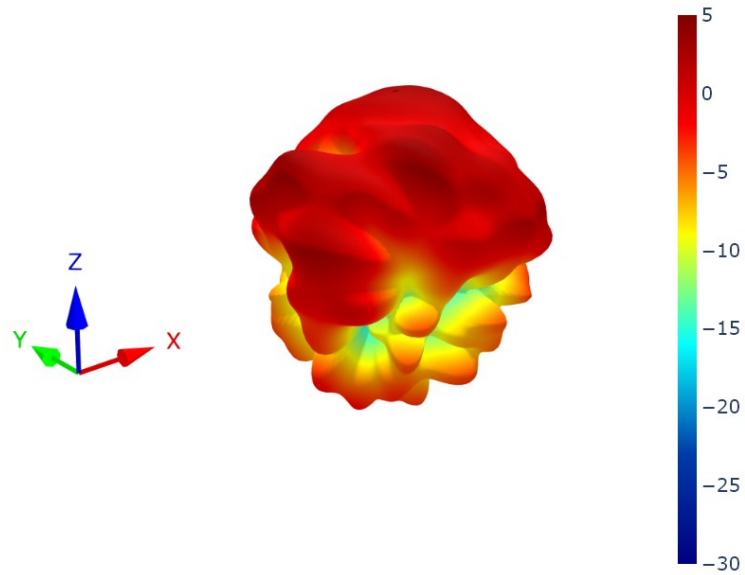

8.95 Cellular 4 Patterns at 4800 MHz

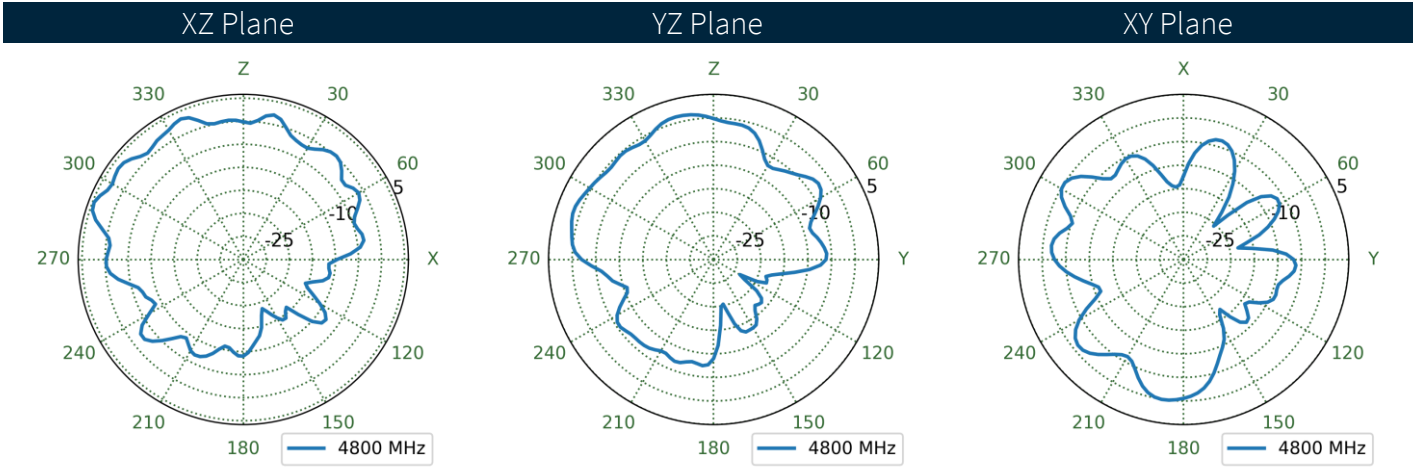
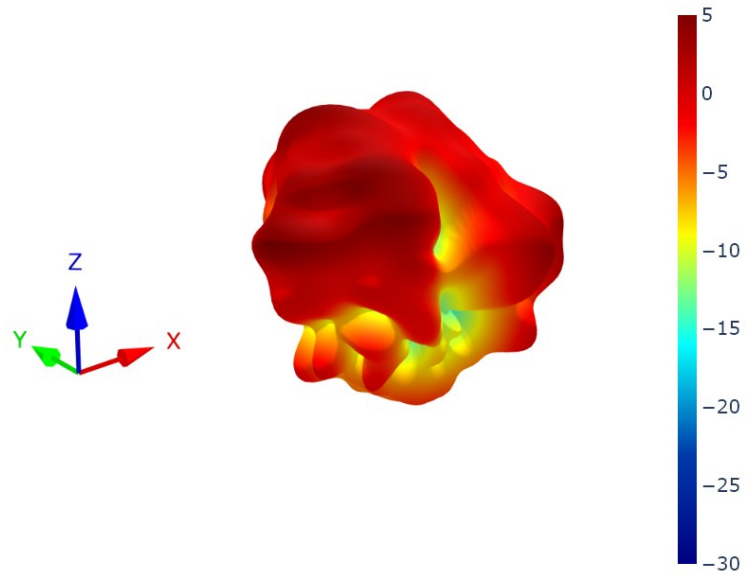

8.96 Cellular 5 Patterns at 4800 MHz

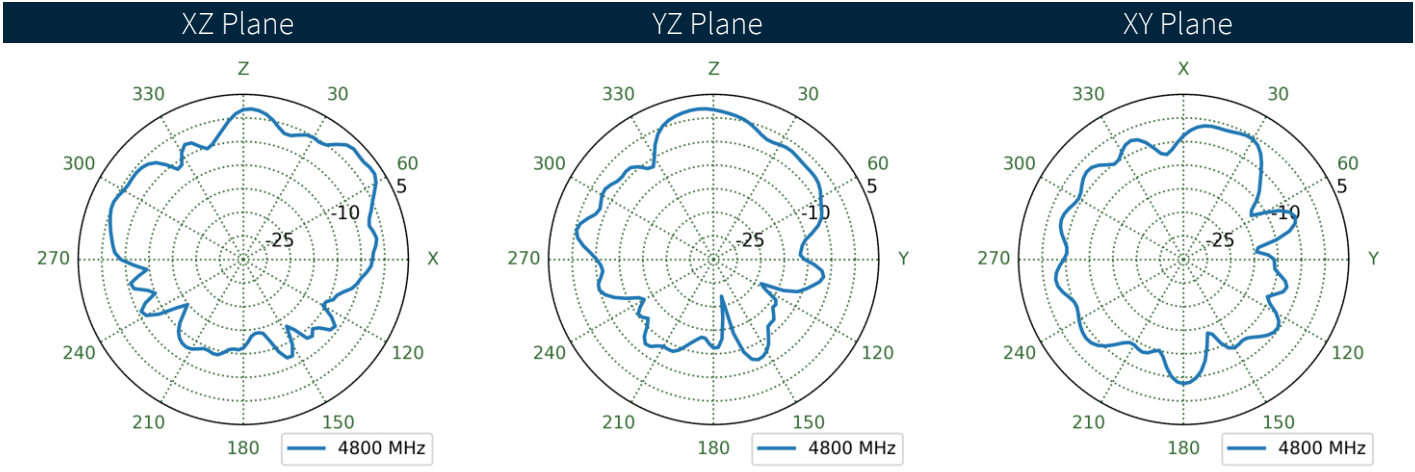
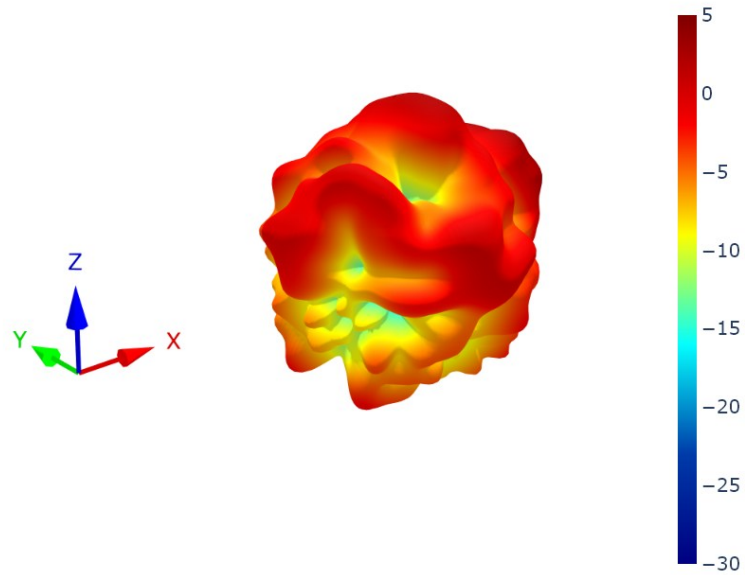

8.97 Cellular 6 Patterns at 4800 MHz

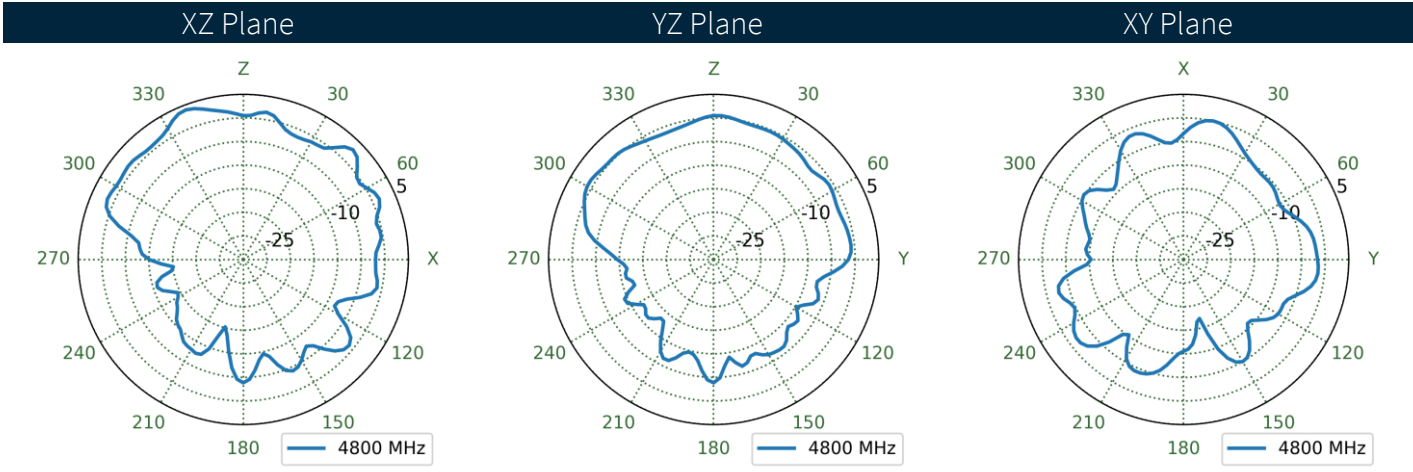
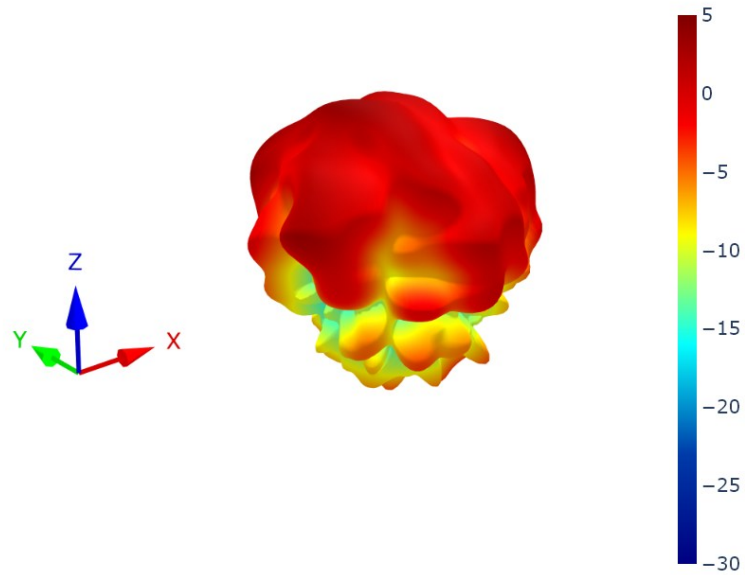

8.98 Cellular 7 Patterns at 4800 MHz

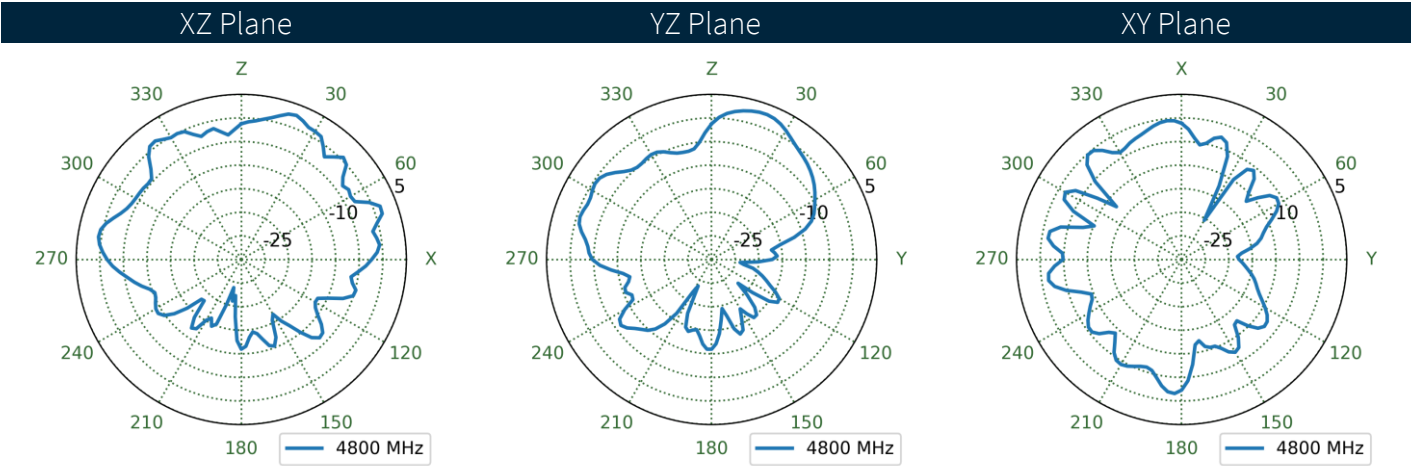
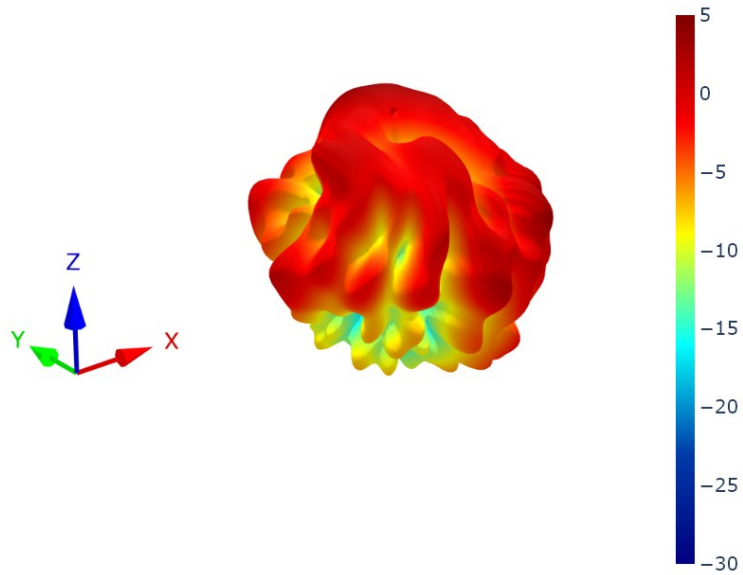

8.99 Cellular 8 Patterns at 4800 MHz

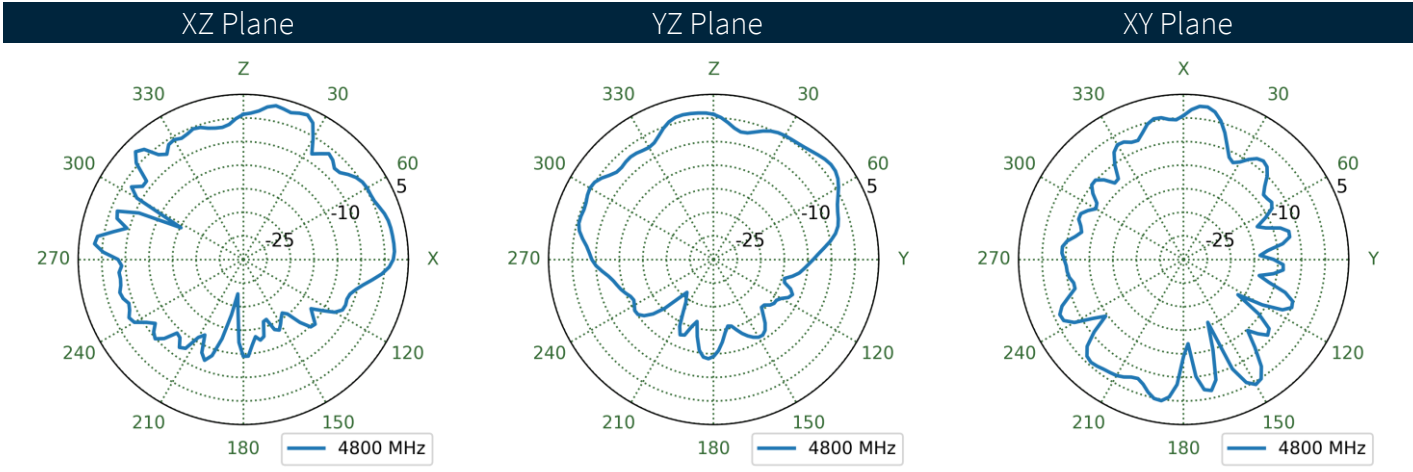
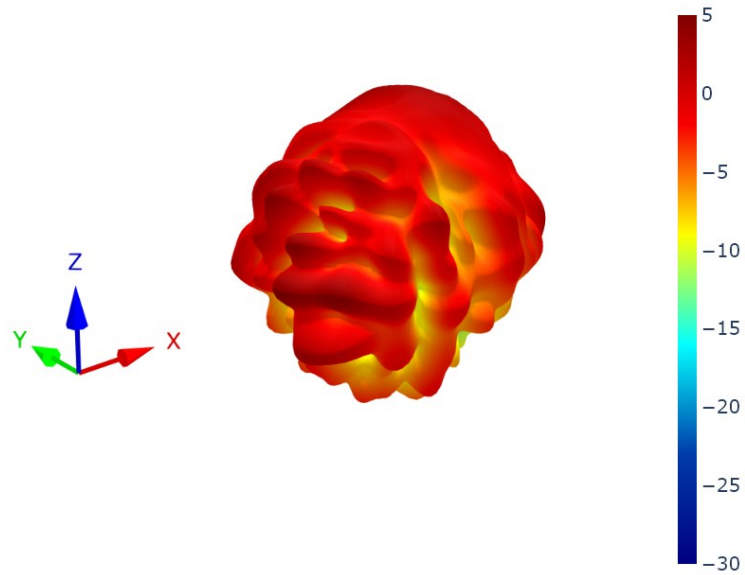

8.100 Cellular 1 Patterns at 5530 MHz

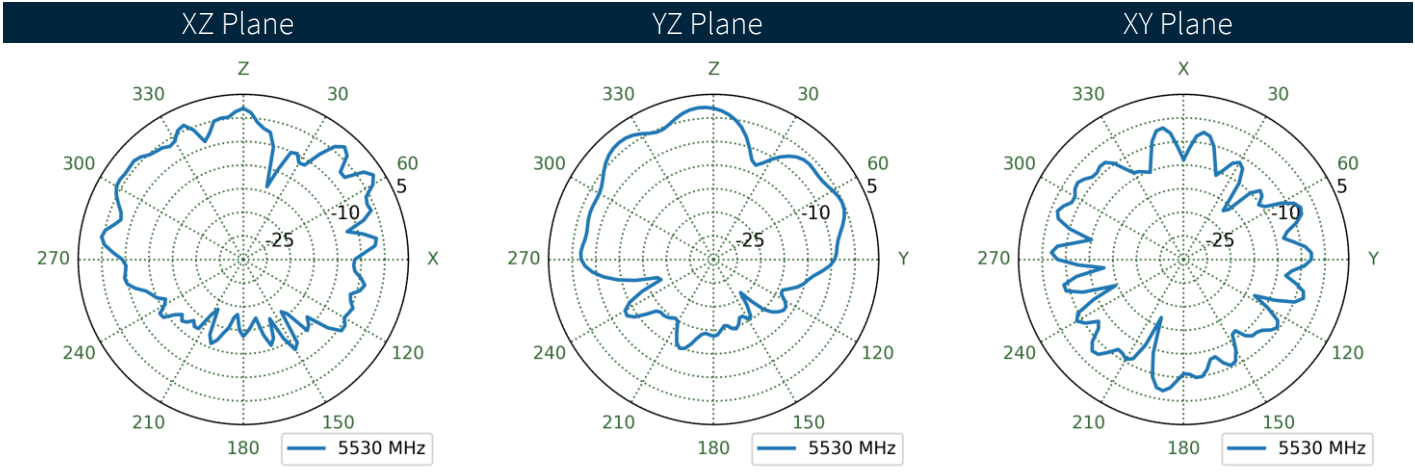
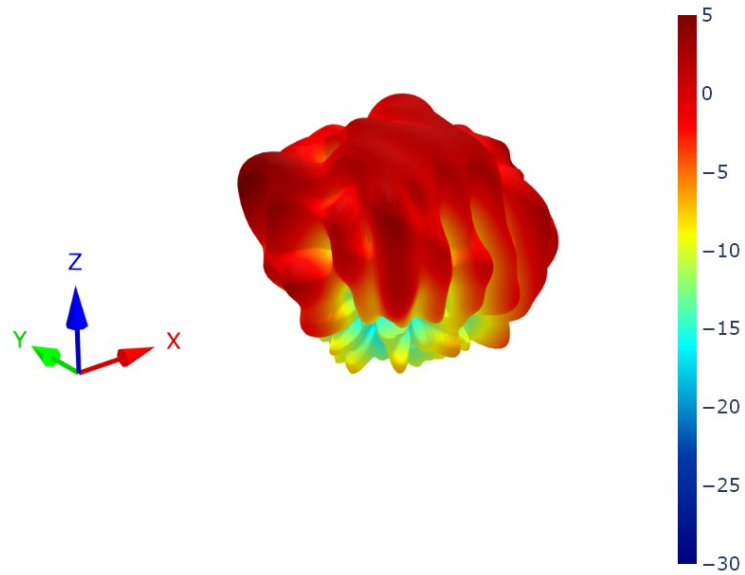

8.101 Cellular 2 Patterns at 5530 MHz

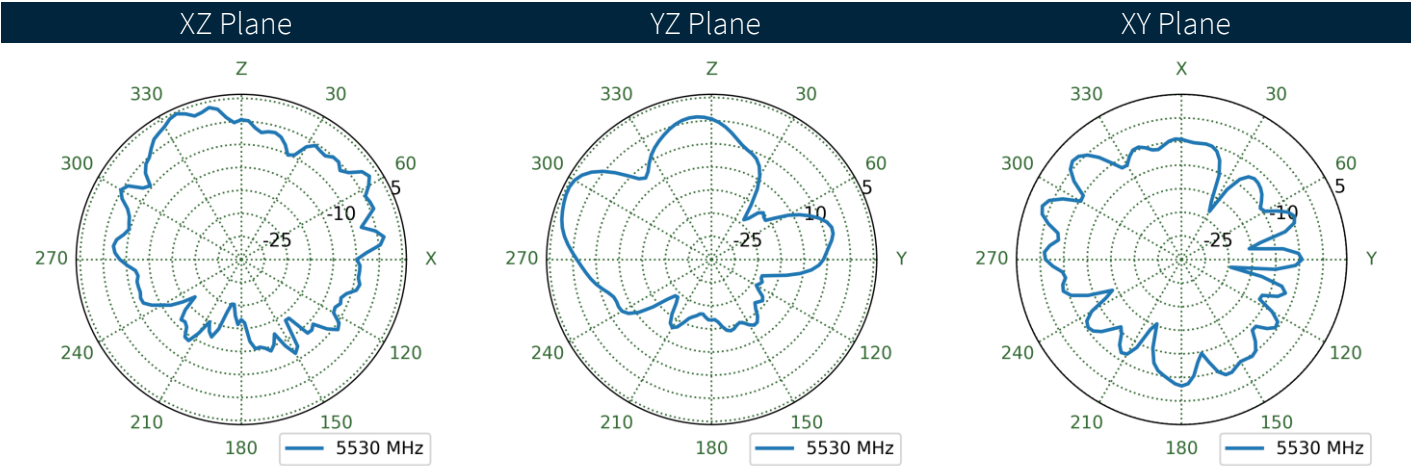
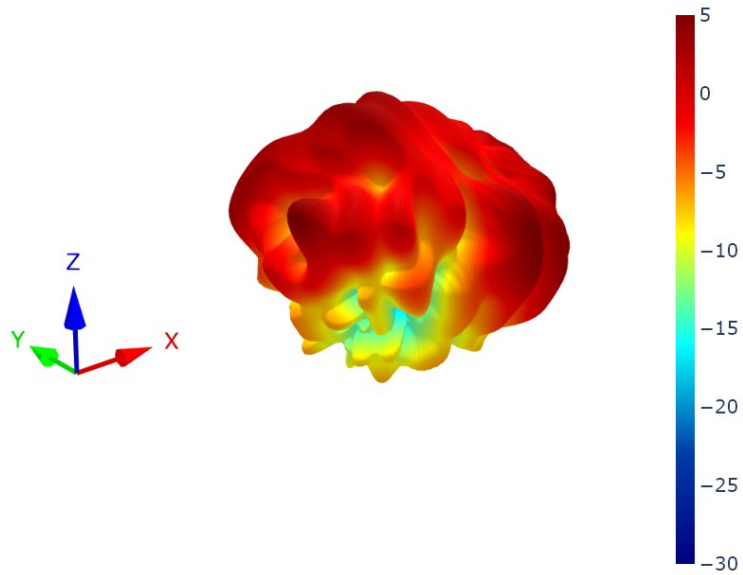

8.102 Cellular 3 Patterns at 5530 MHz

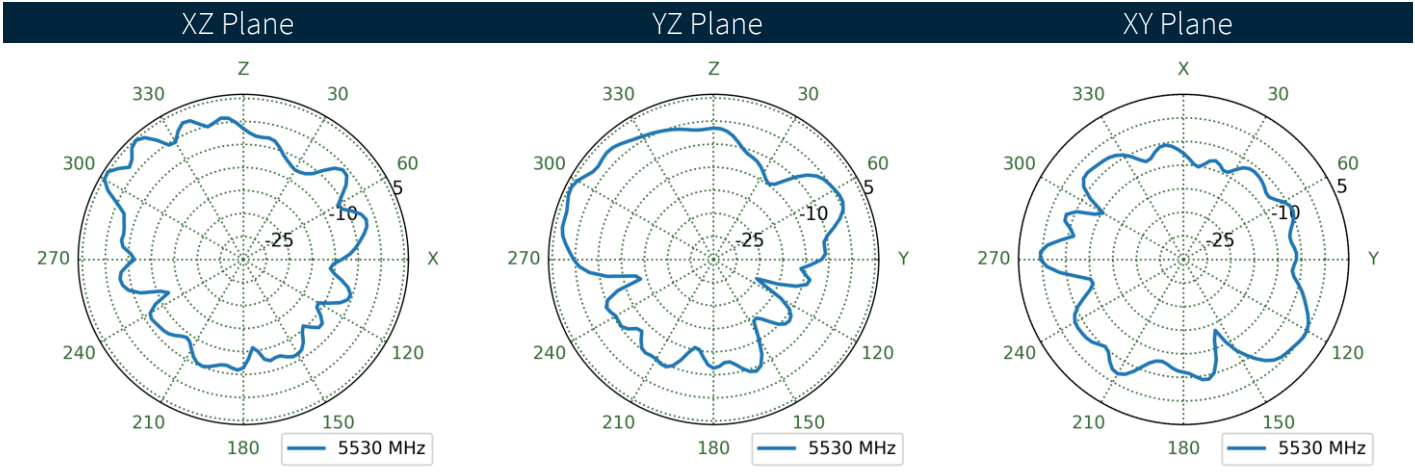
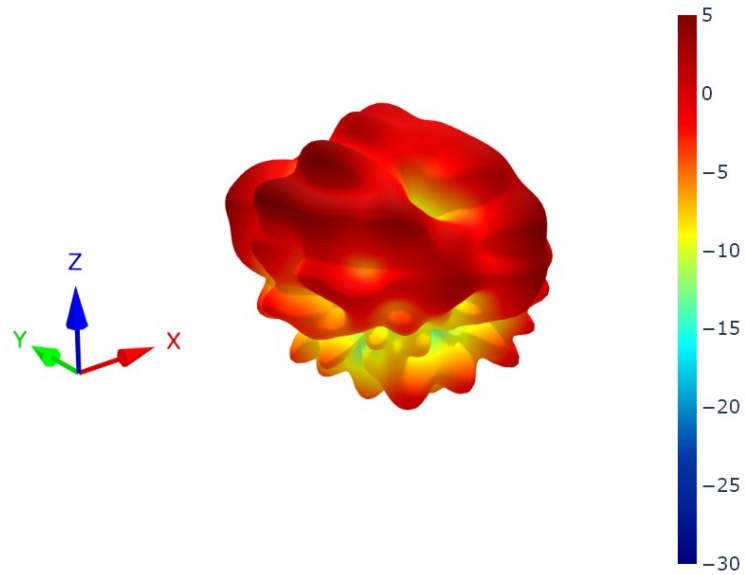

8.103 Cellular 4 Patterns at 5530 MHz

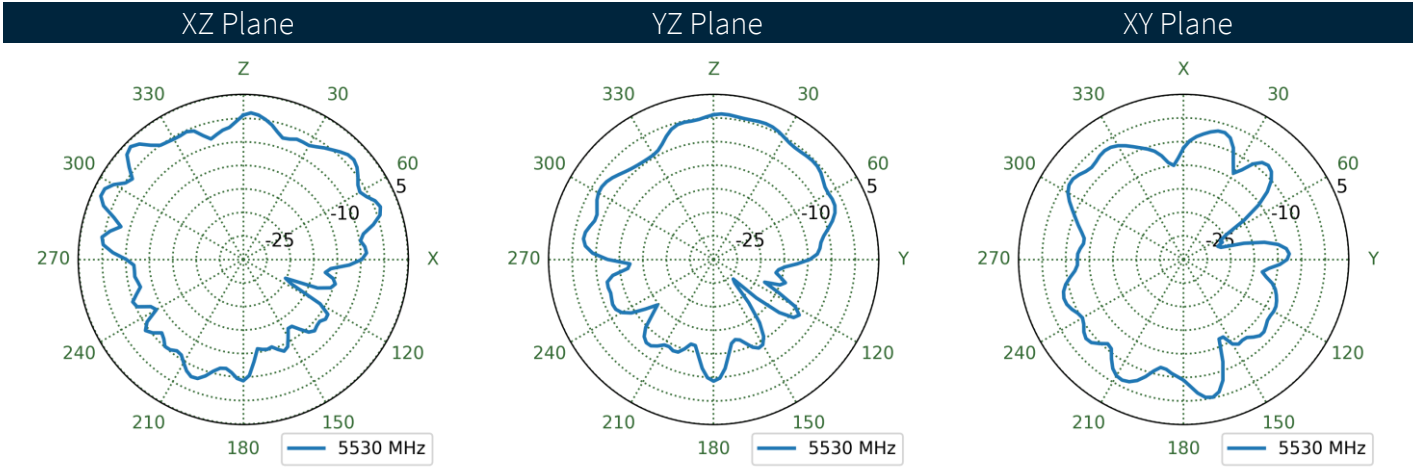
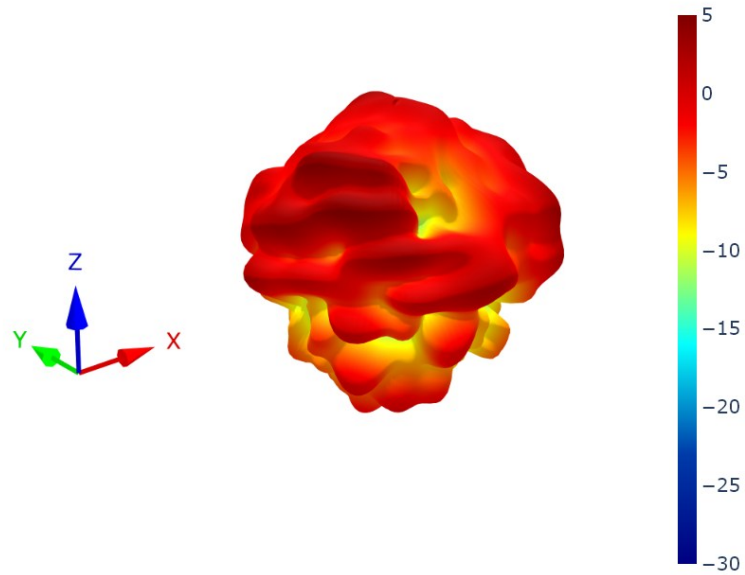

8.104 Cellular 5 Patterns at 5530 MHz

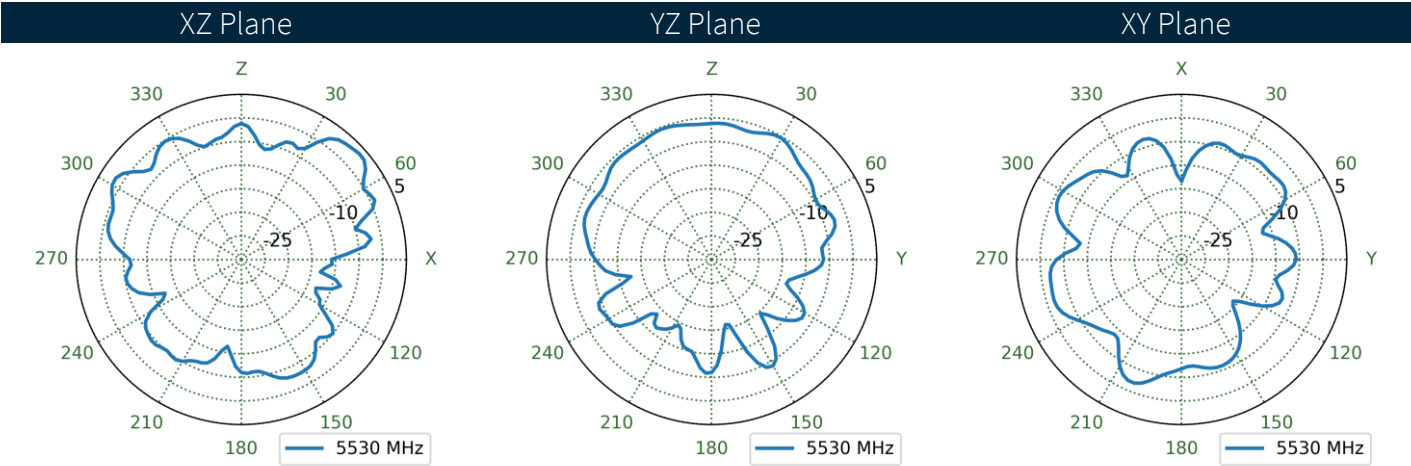
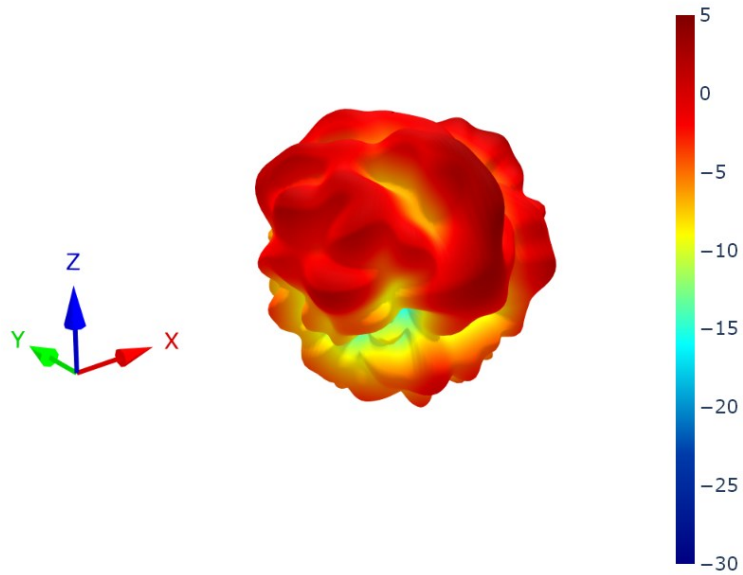

8.105 Cellular 6 Patterns at 5530 MHz

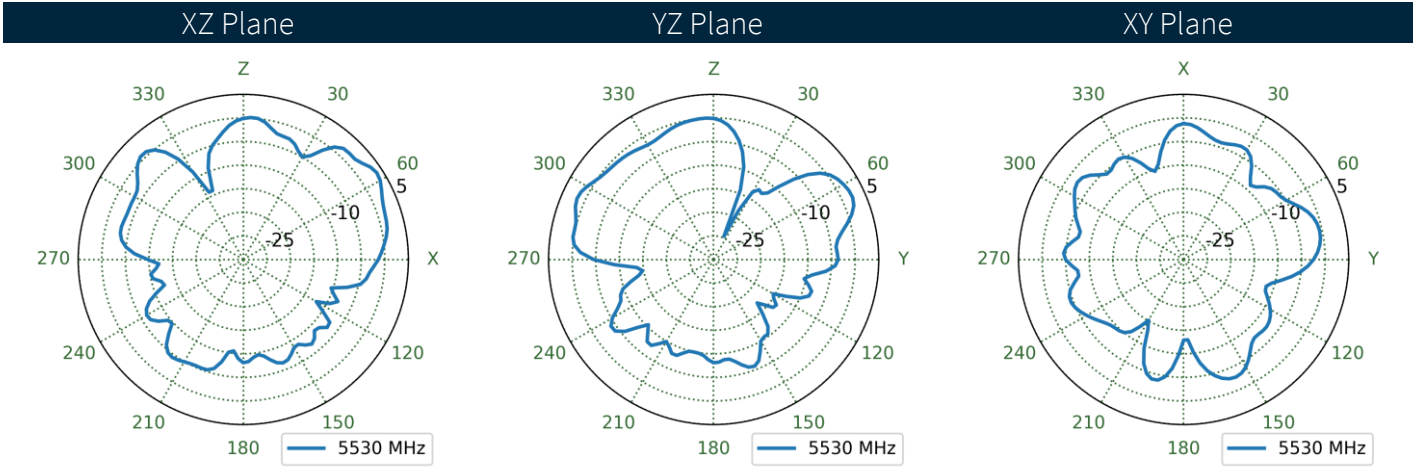
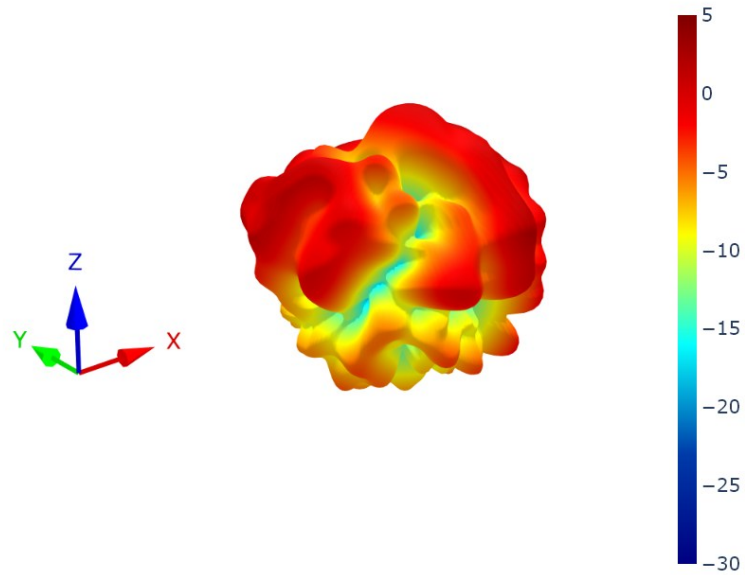

8.106 Cellular 7 Patterns at 5530 MHz

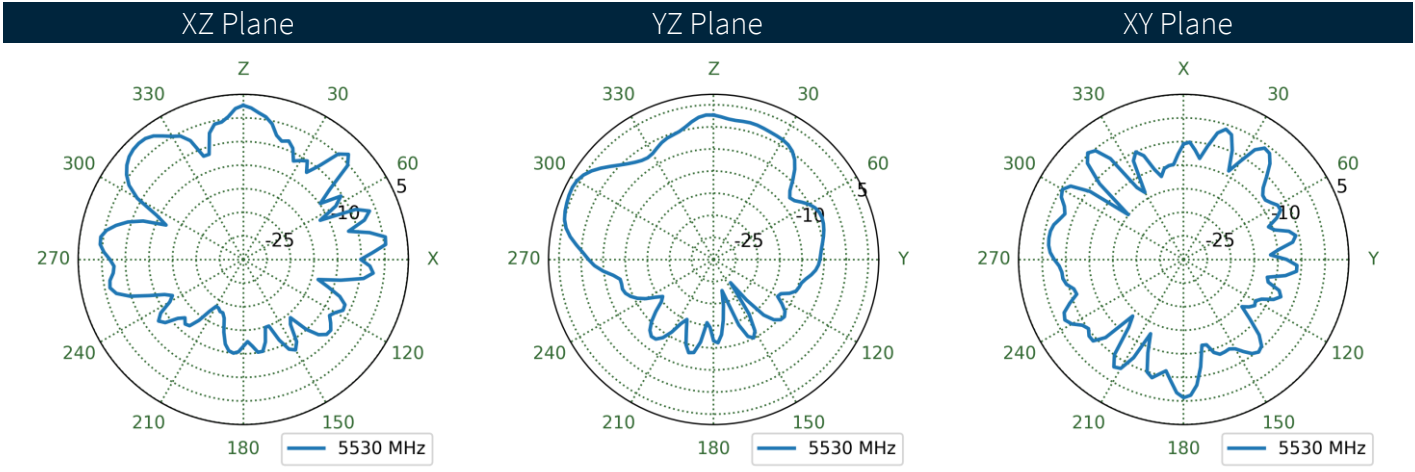
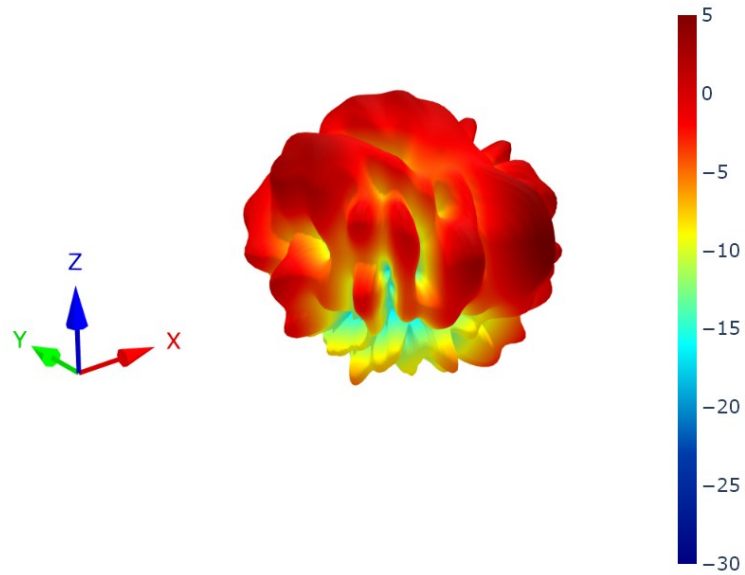

8.107 Cellular 8 Patterns at 5530 MHz

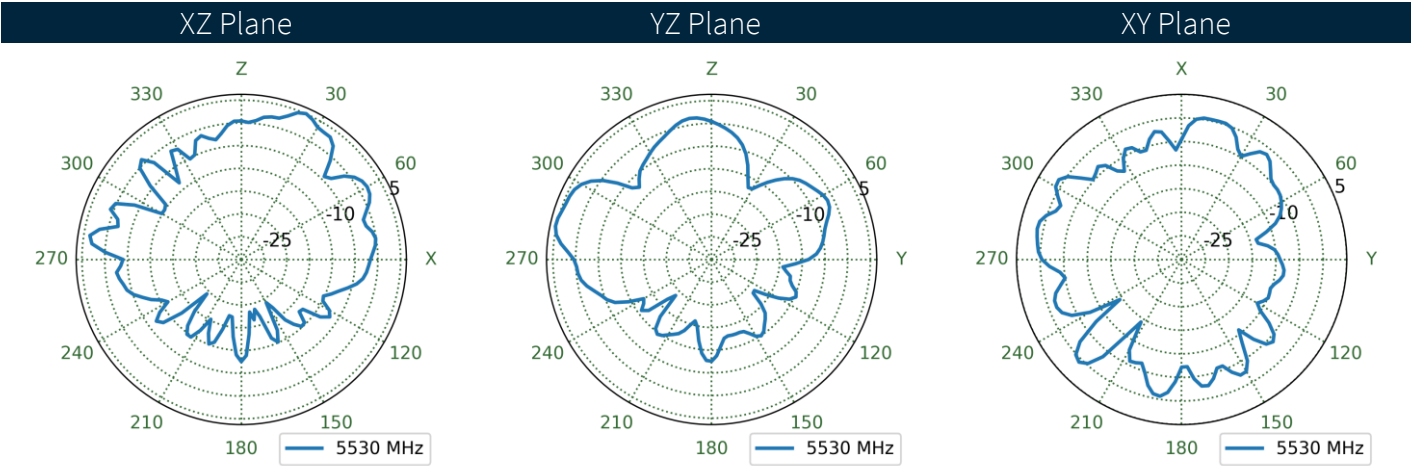
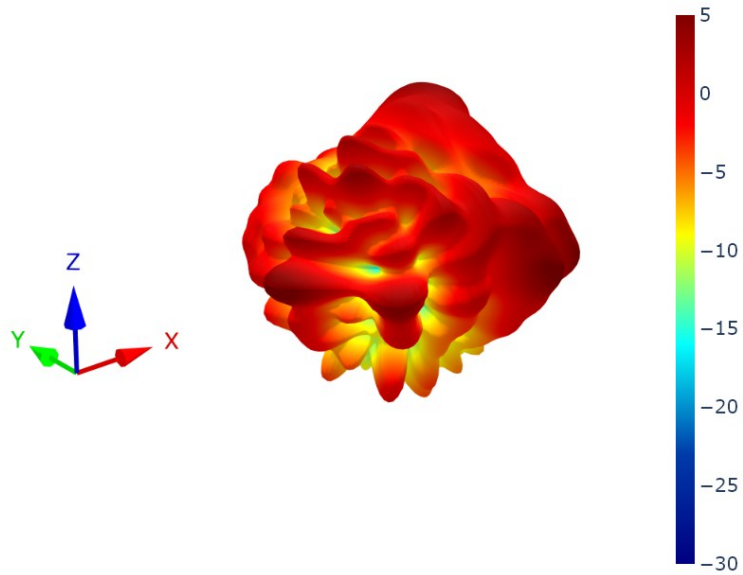

8.108 Wi-Fi1 Patterns at 2450 MHz

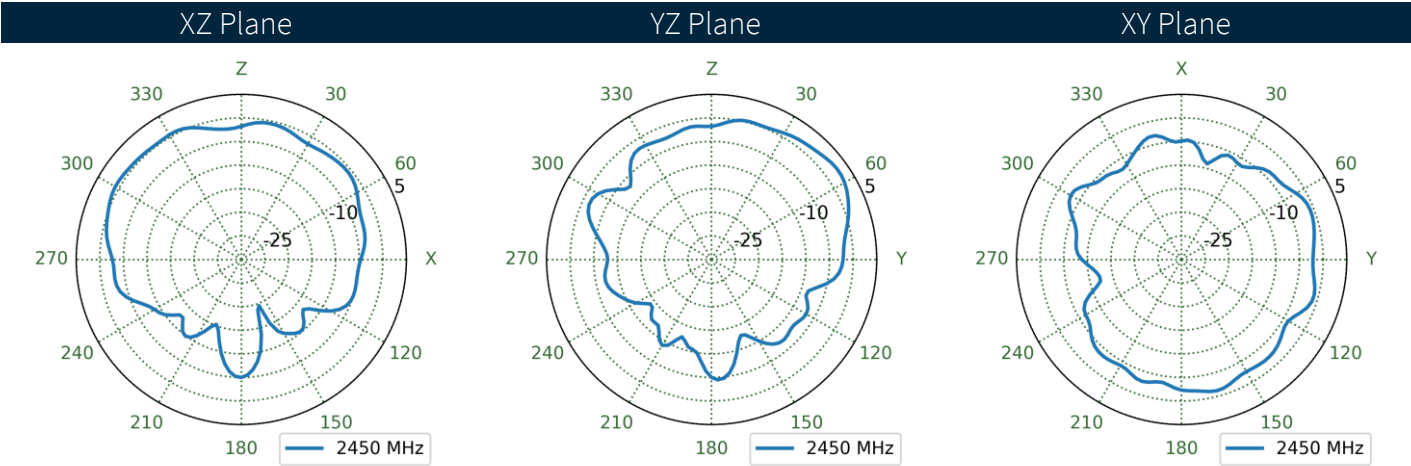
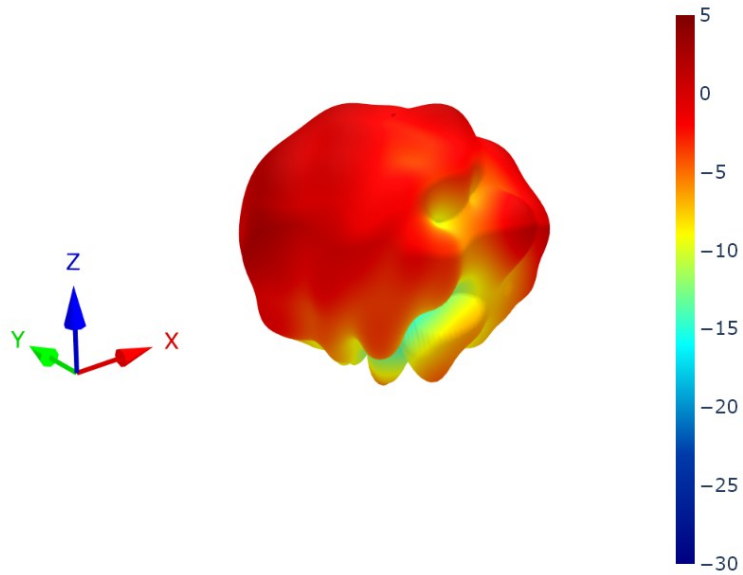

8.109 Wi-Fi2 Patterns at 2450 MHz

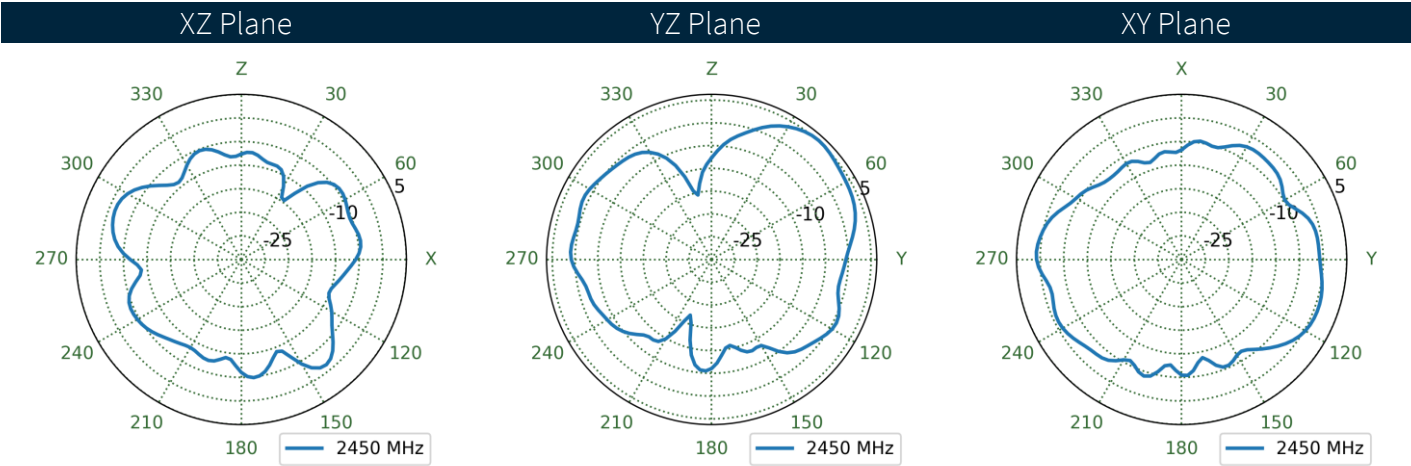
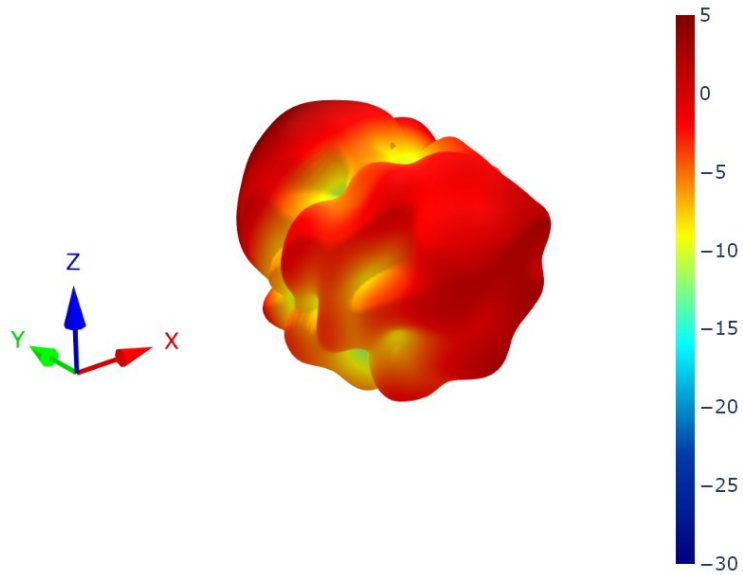

8.110 Wi-Fi3 Patterns at 2450 MHz

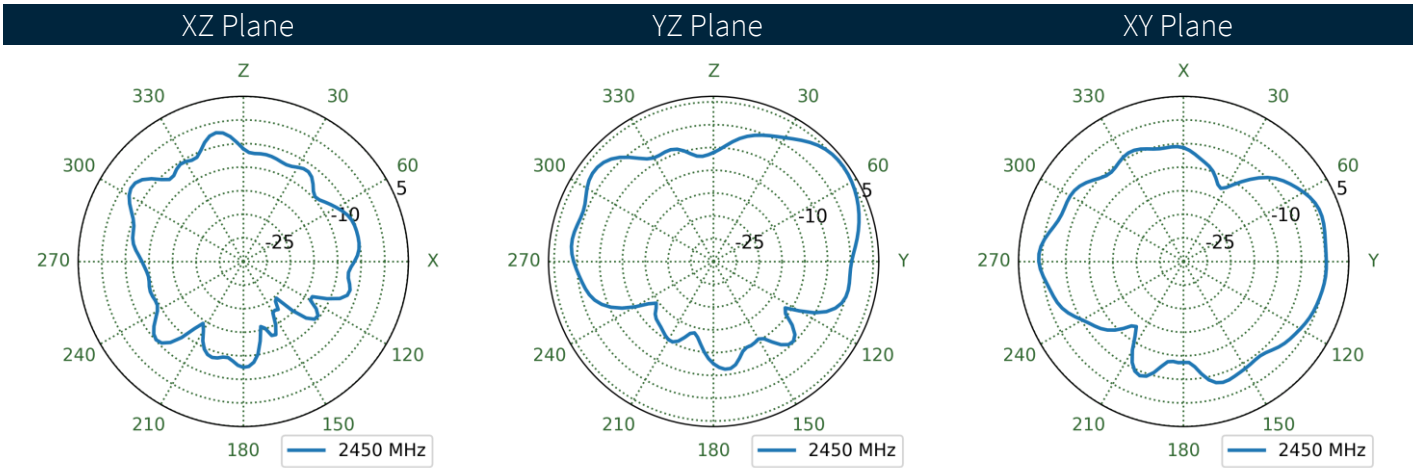
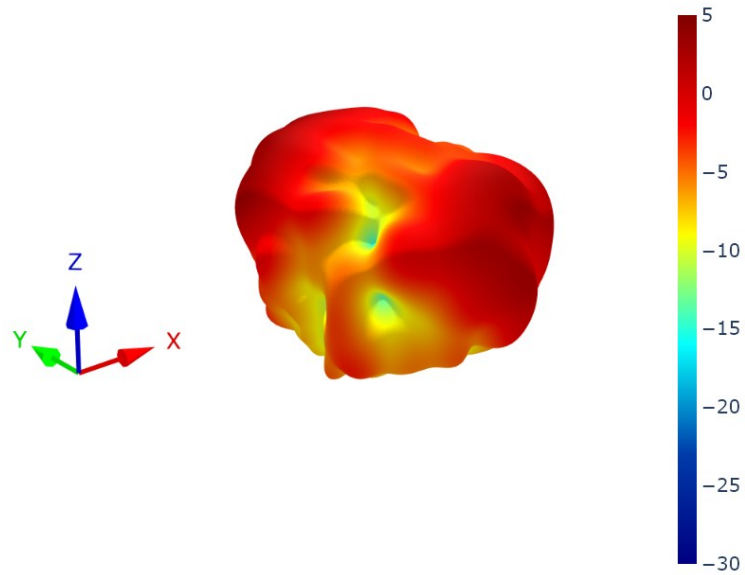

8.111 Wi-Fi4 Patterns at 2450 MHz

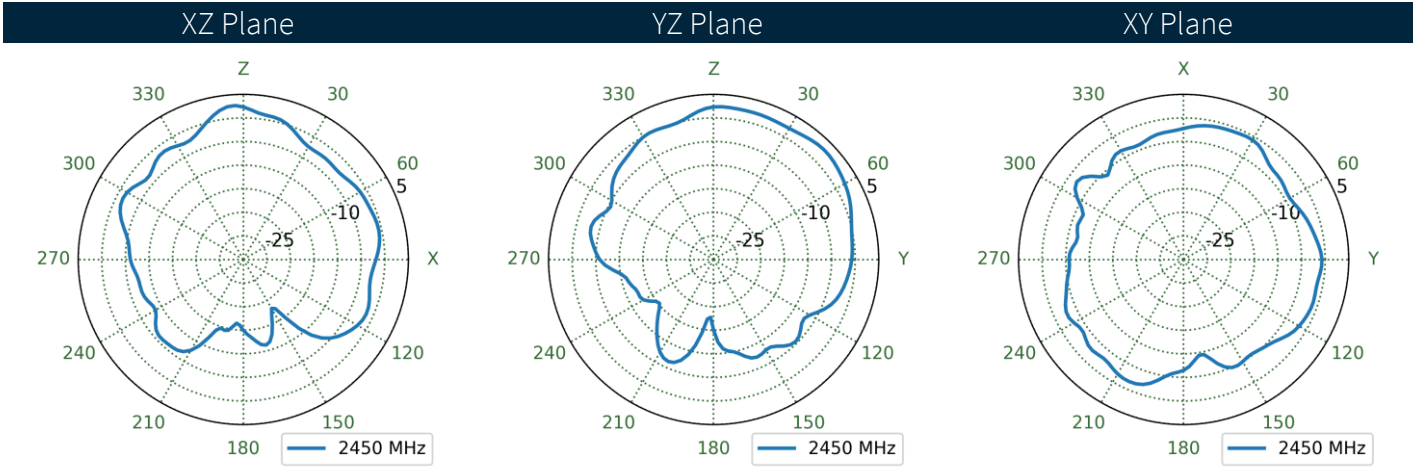
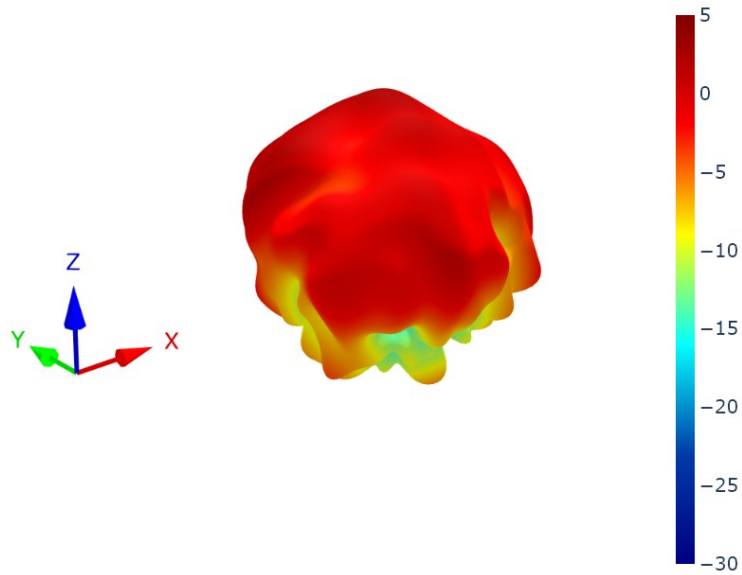

8.112 Wi-Fi5 Patterns at 2450 MHz

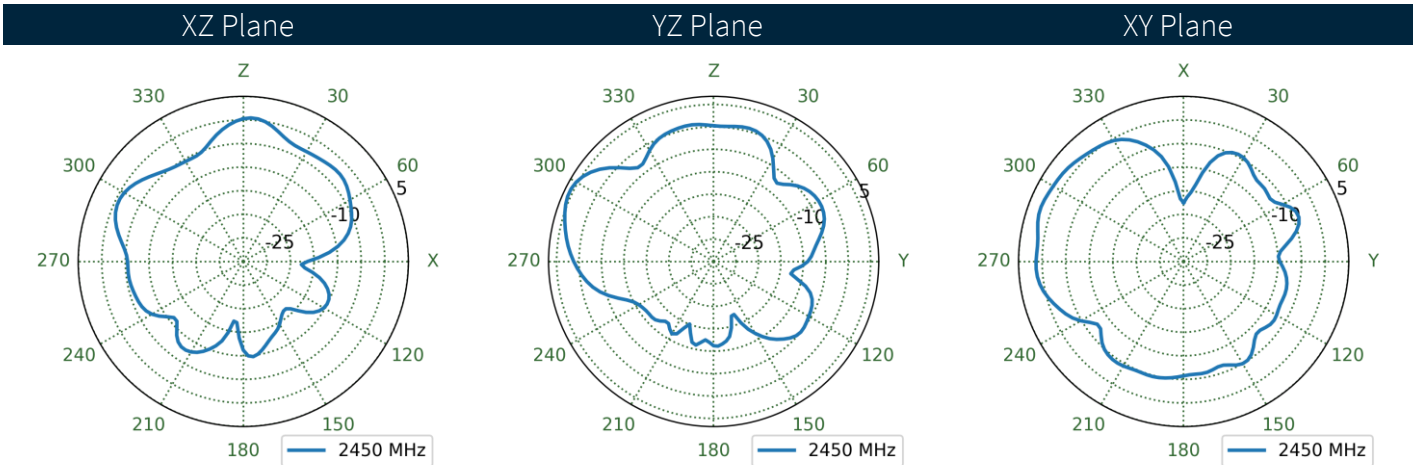
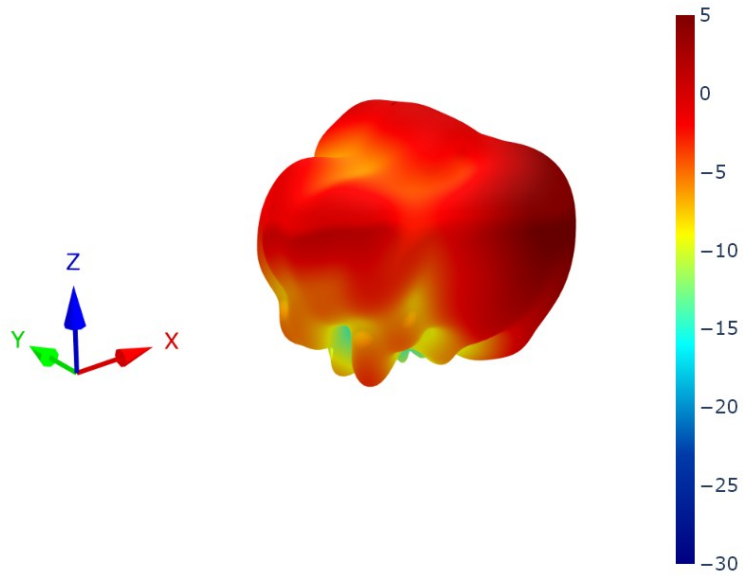

8.113 Wi-Fi6 Patterns at 2450 MHz

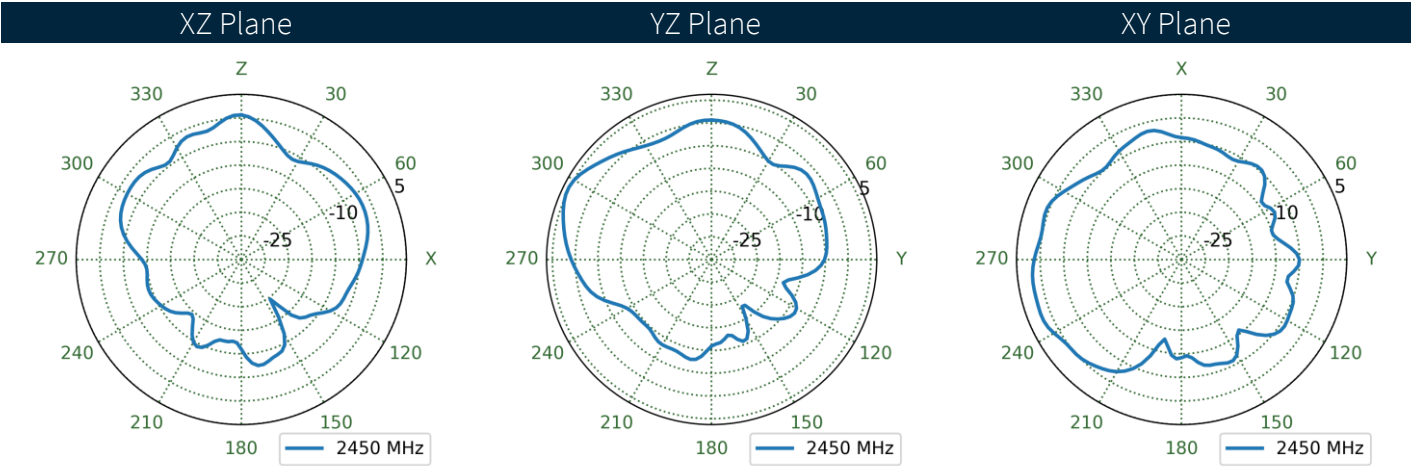
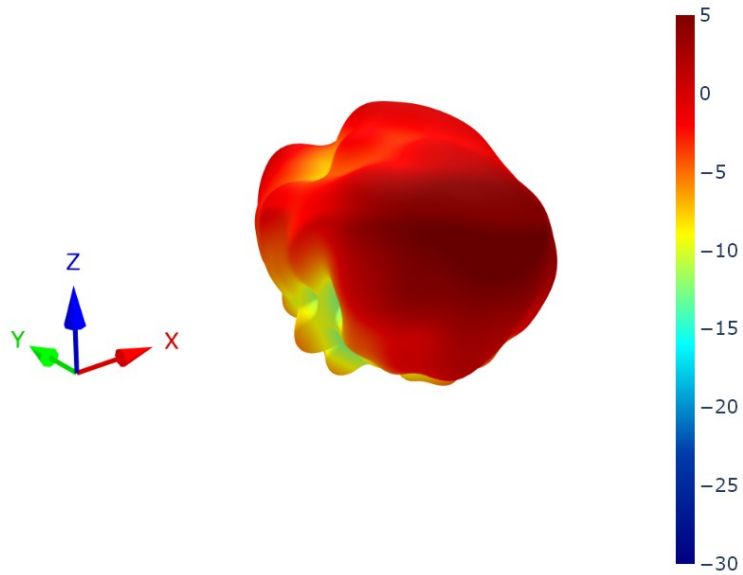

8.114 Wi-Fi1 Patterns at 5490 MHz

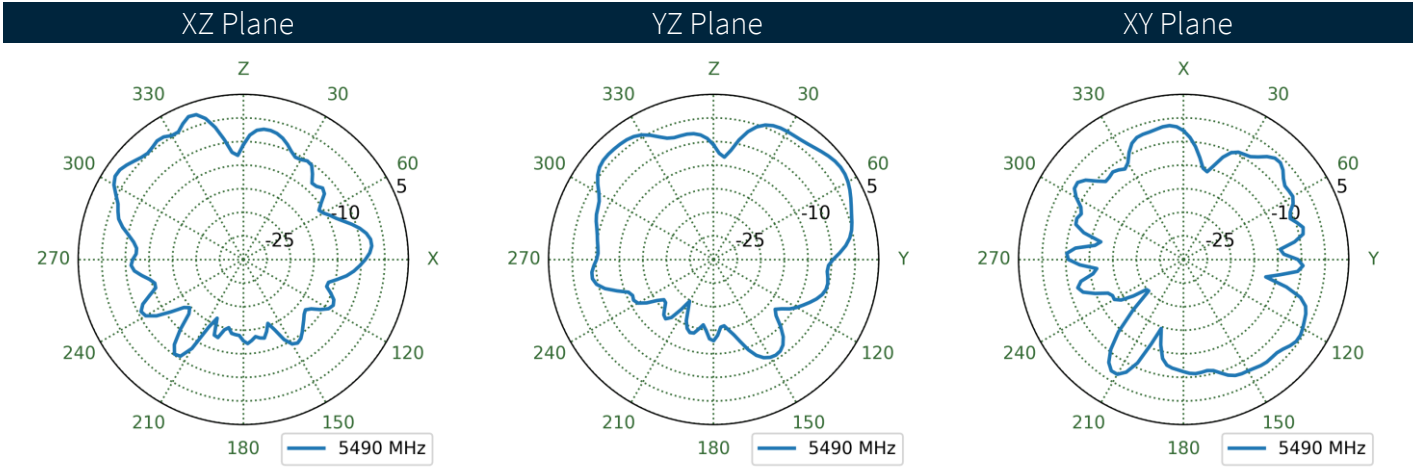
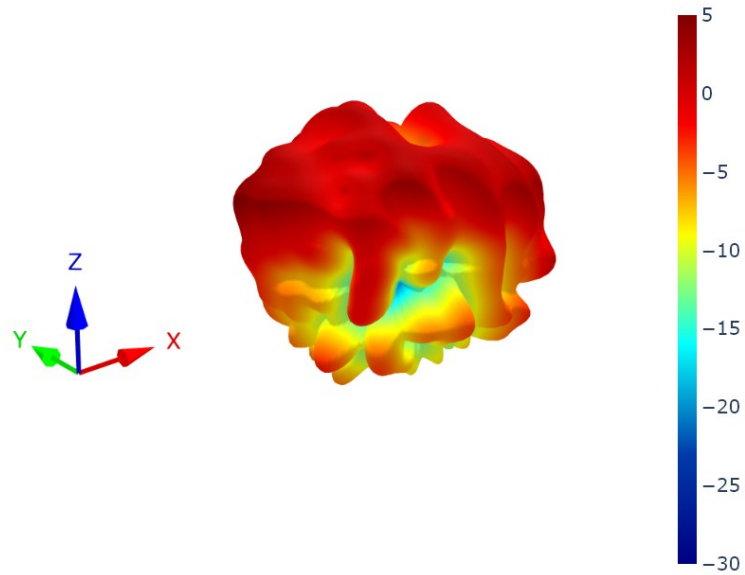

8.115 Wi-Fi2 Patterns at 5490 MHz

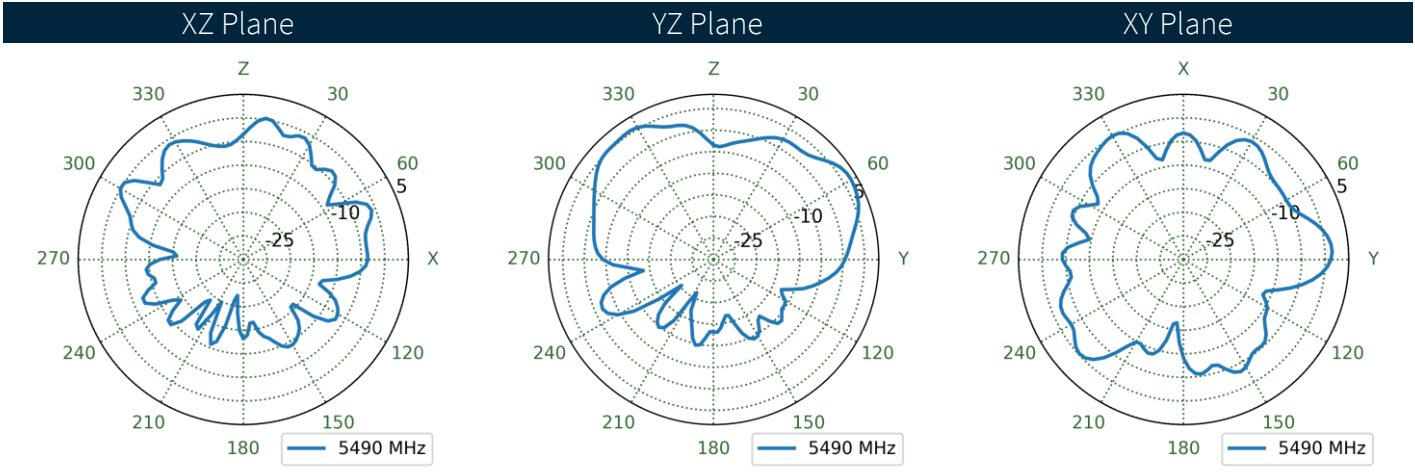
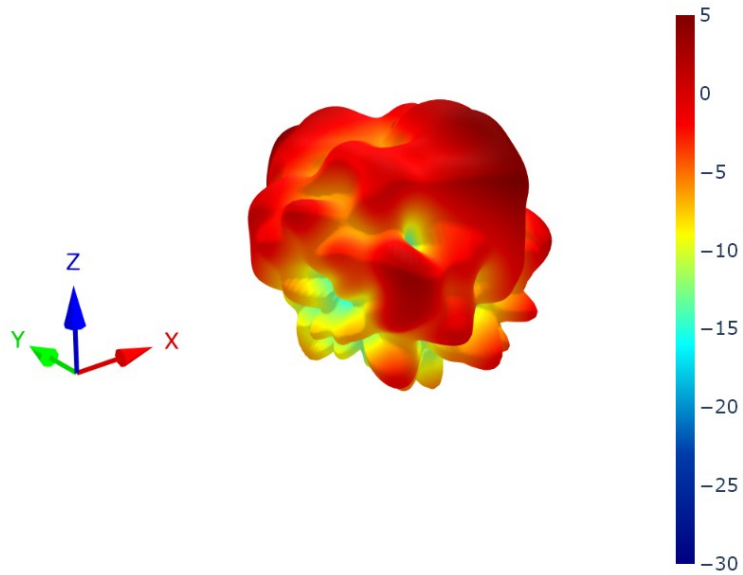

8.116 Wi-Fi3 Patterns at 5490 MHz

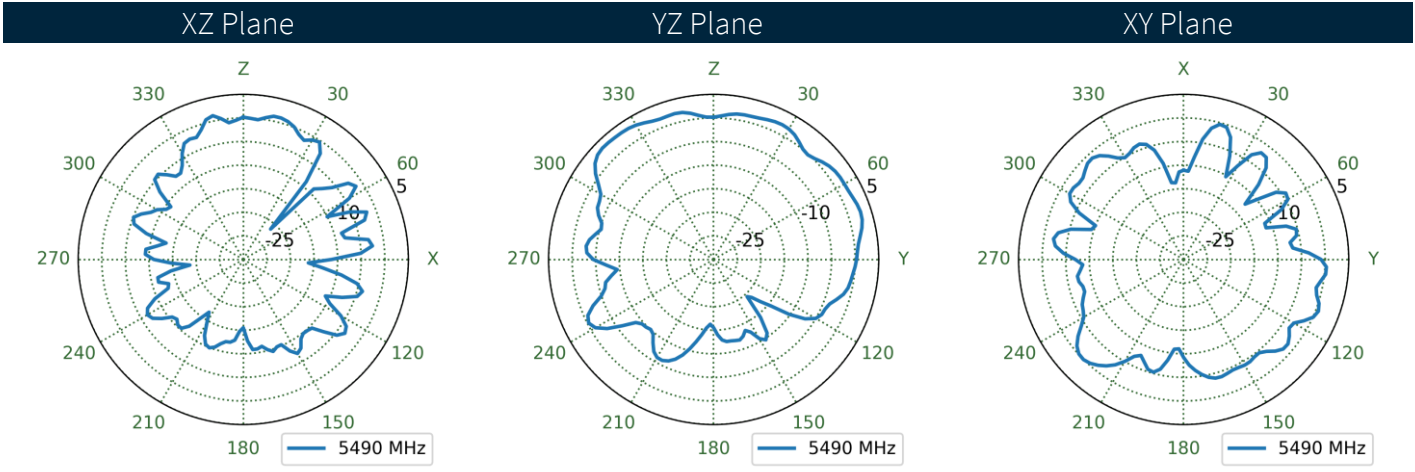
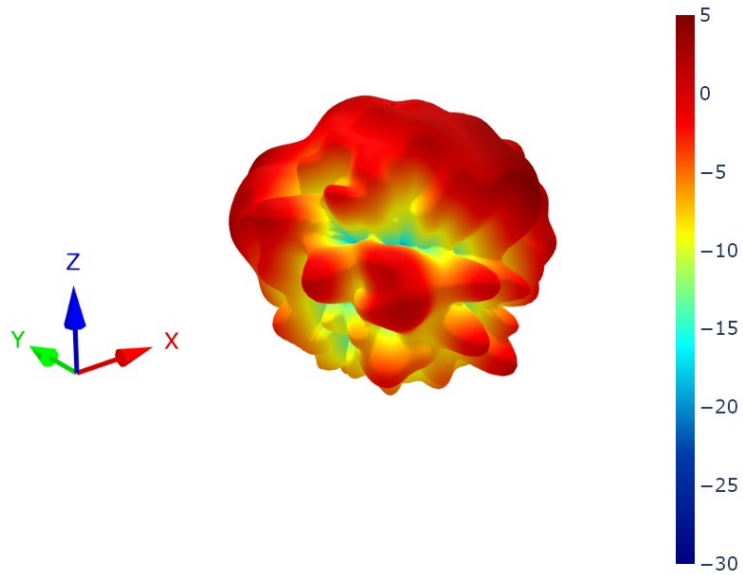

8.117 Wi-Fi4 Patterns at 5490 MHz

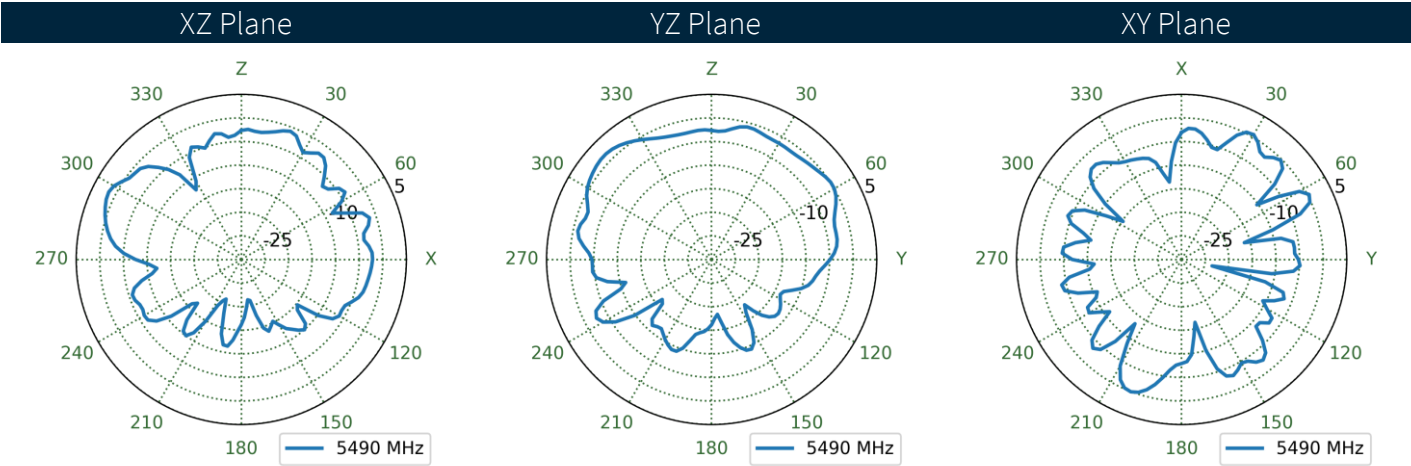
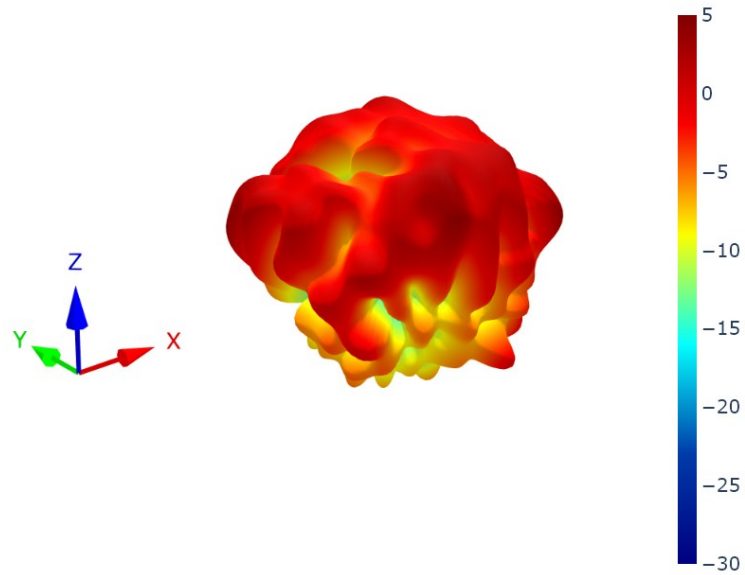

8.118 Wi-Fi5 Patterns at 5490 MHz

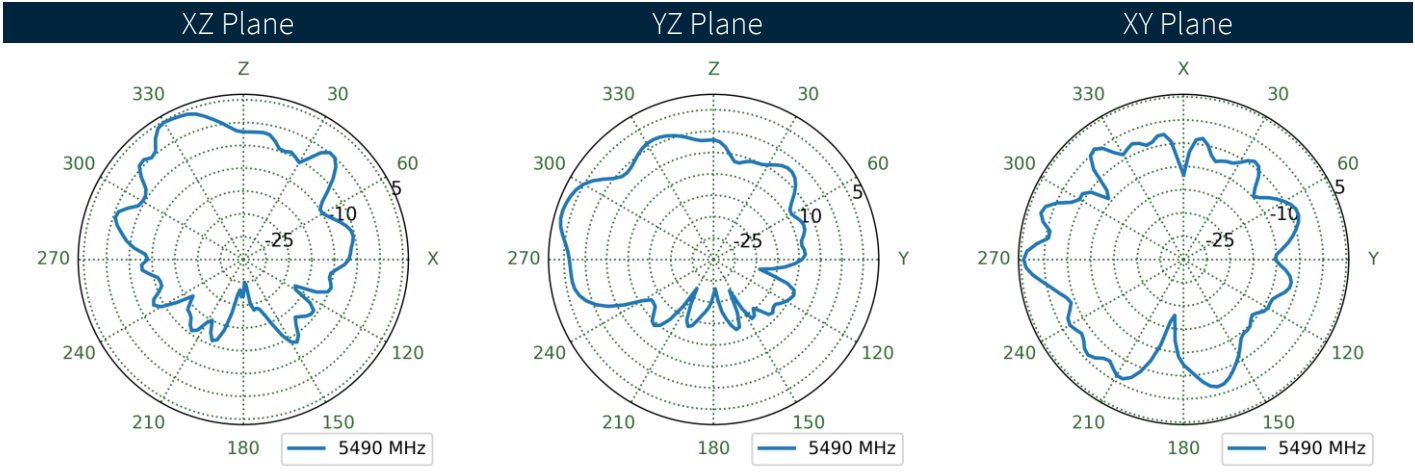
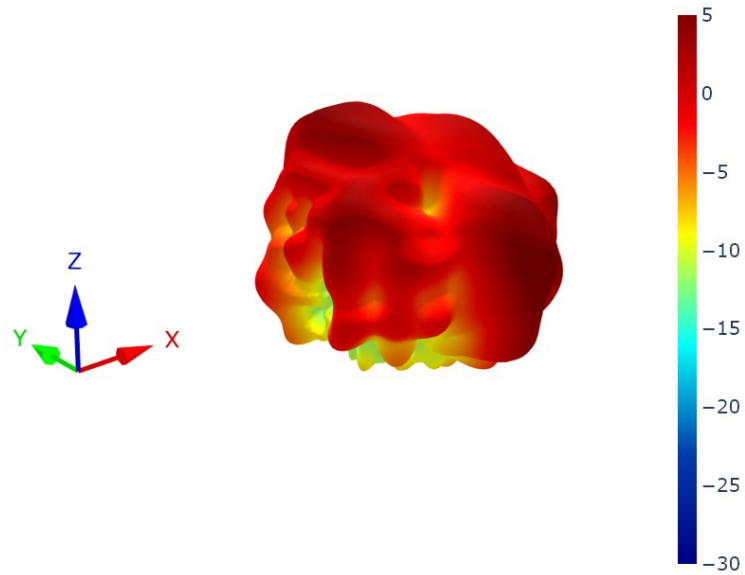

8.119 Wi-Fi6 Patterns at 5490 MHz

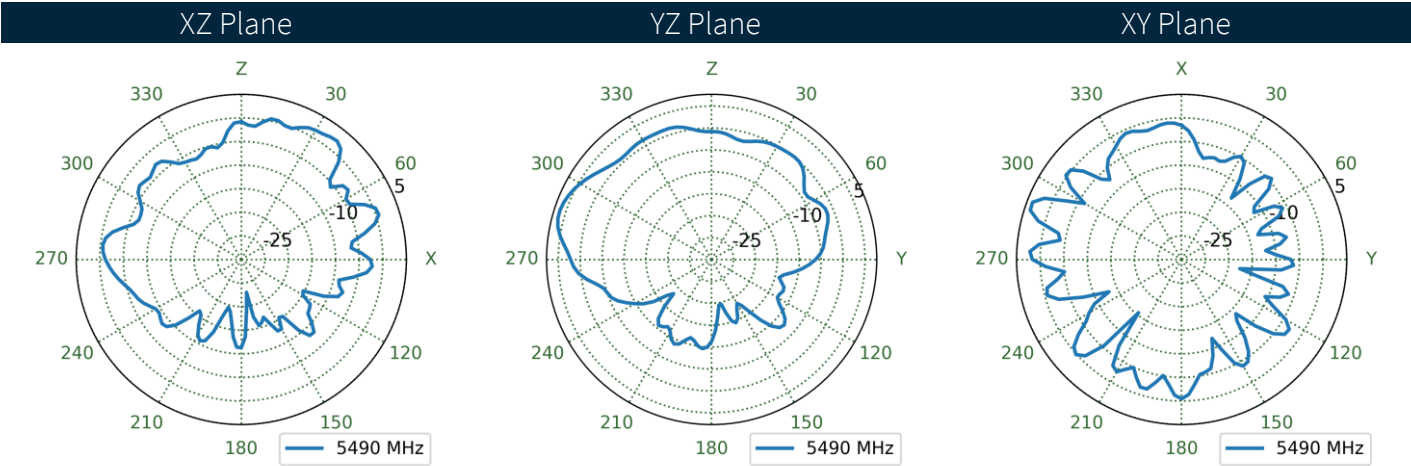
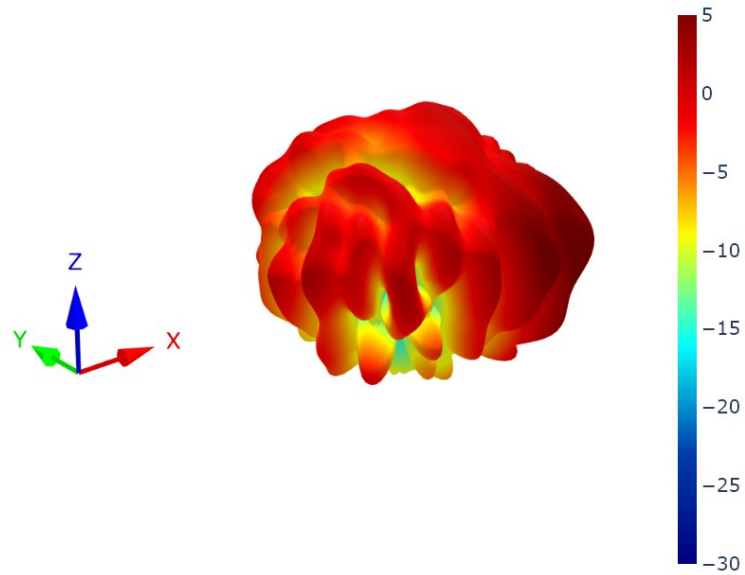

8.120 Wi-Fi1 Patterns at 6525 MHz

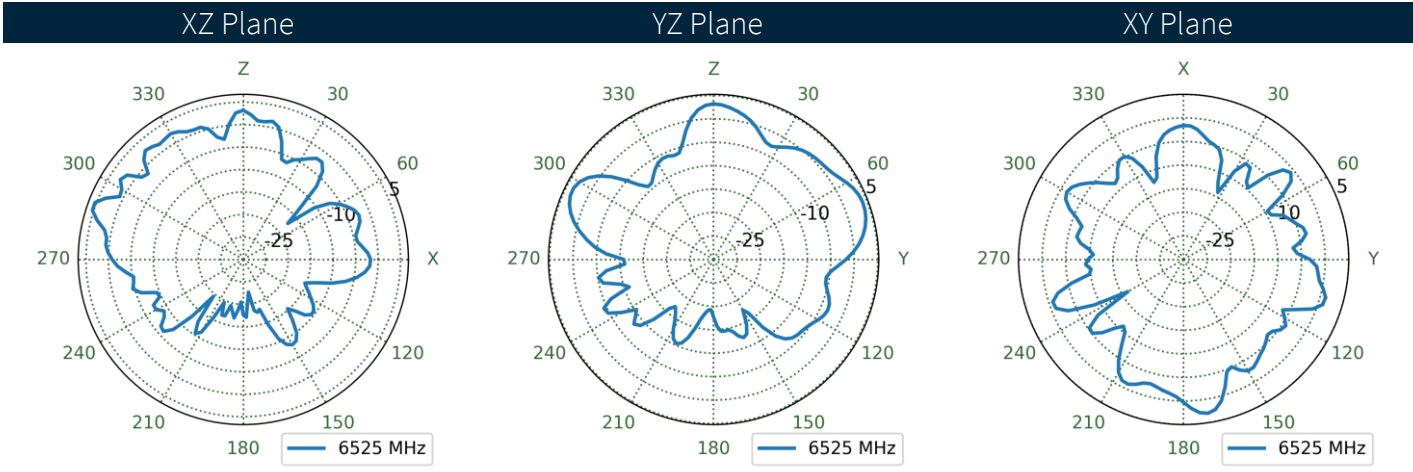
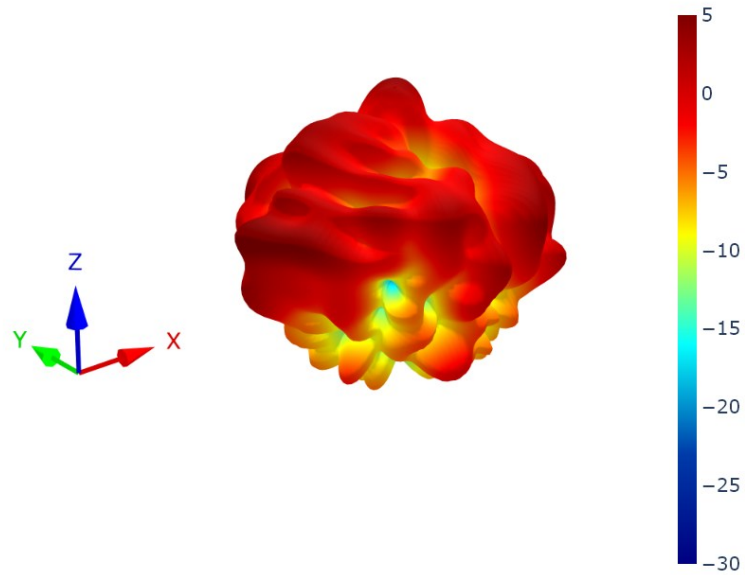

8.121 Wi-Fi2 Patterns at 6525 MHz

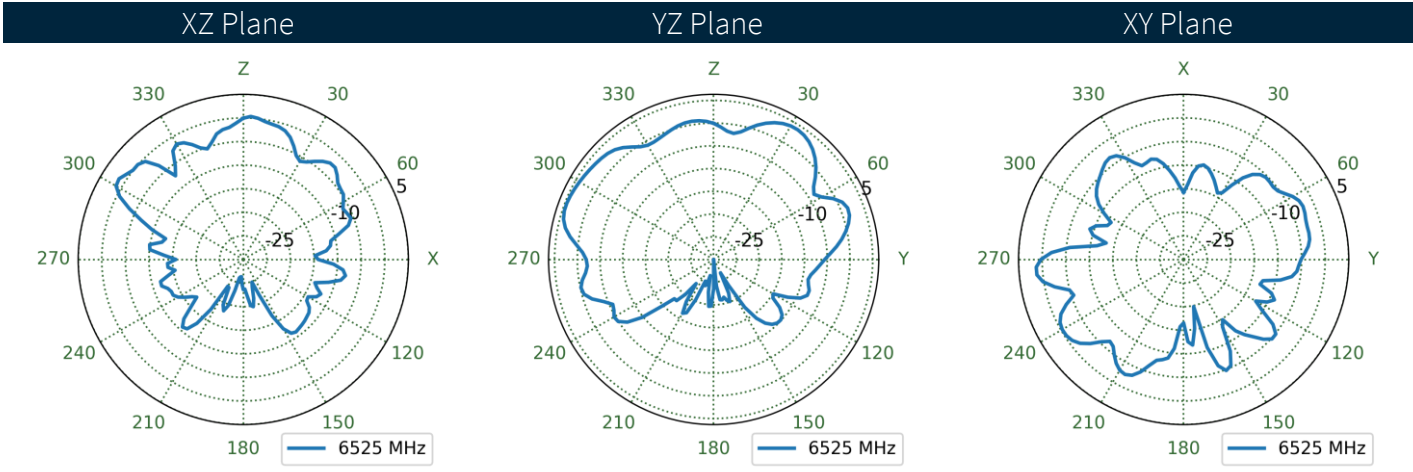
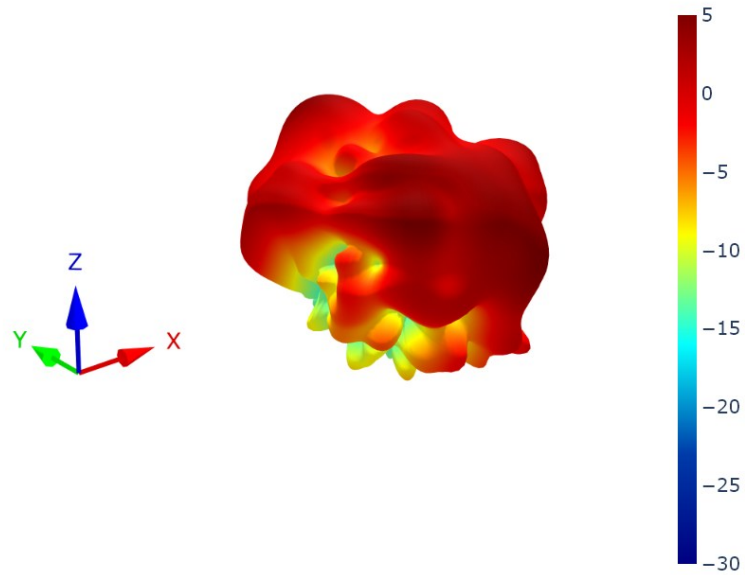

8.122 Wi-Fi3 Patterns at 6525 MHz

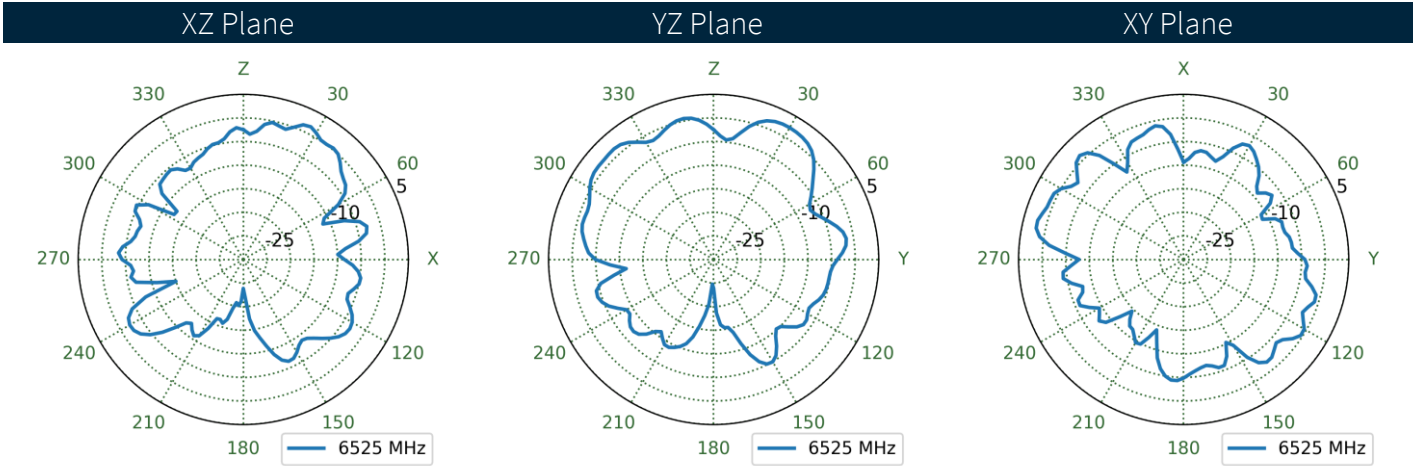
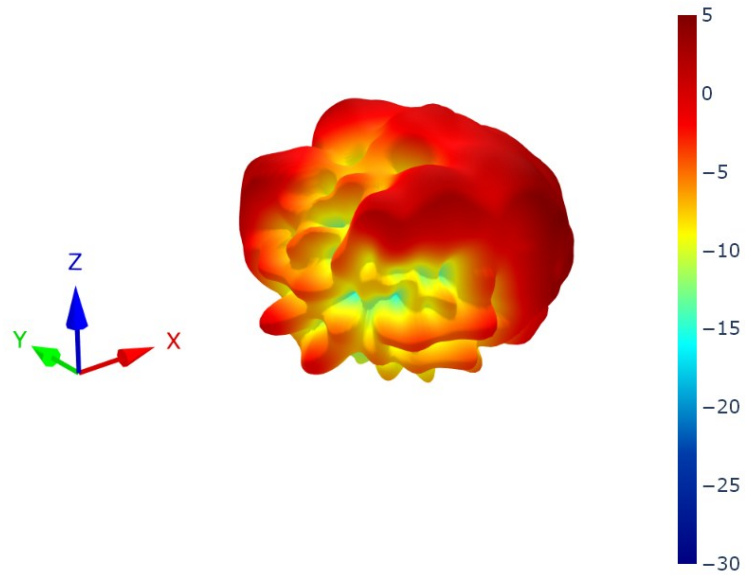

8.123 Wi-Fi4 Patterns at 6525 MHz

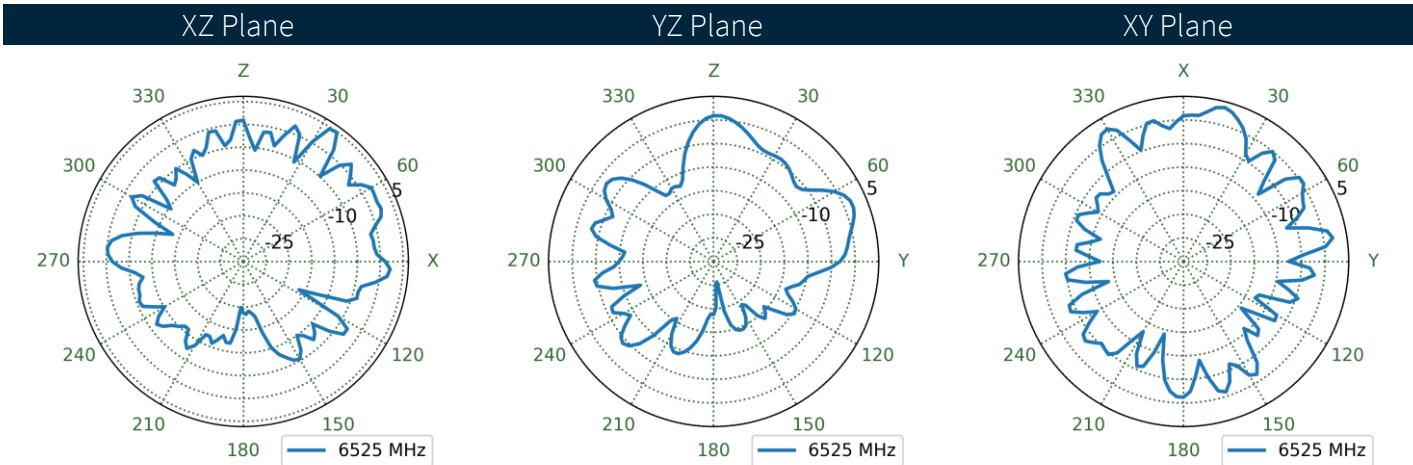
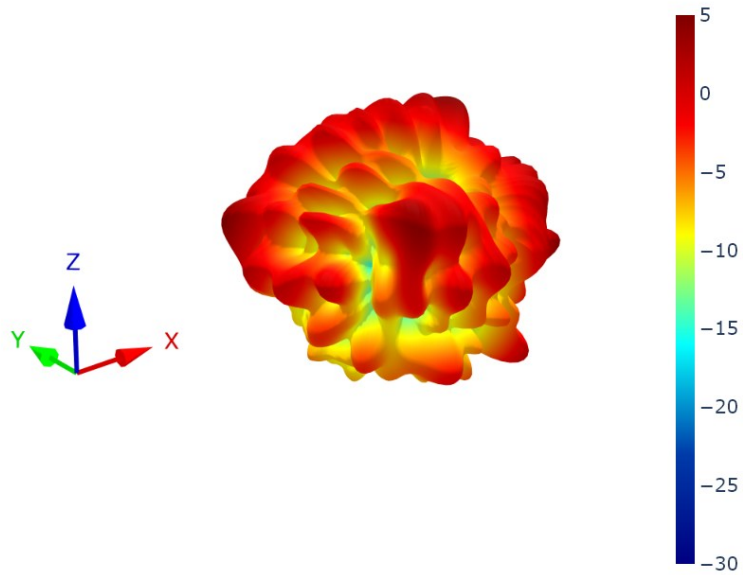

8.124 Wi-Fi5 Patterns at 6525 MHz

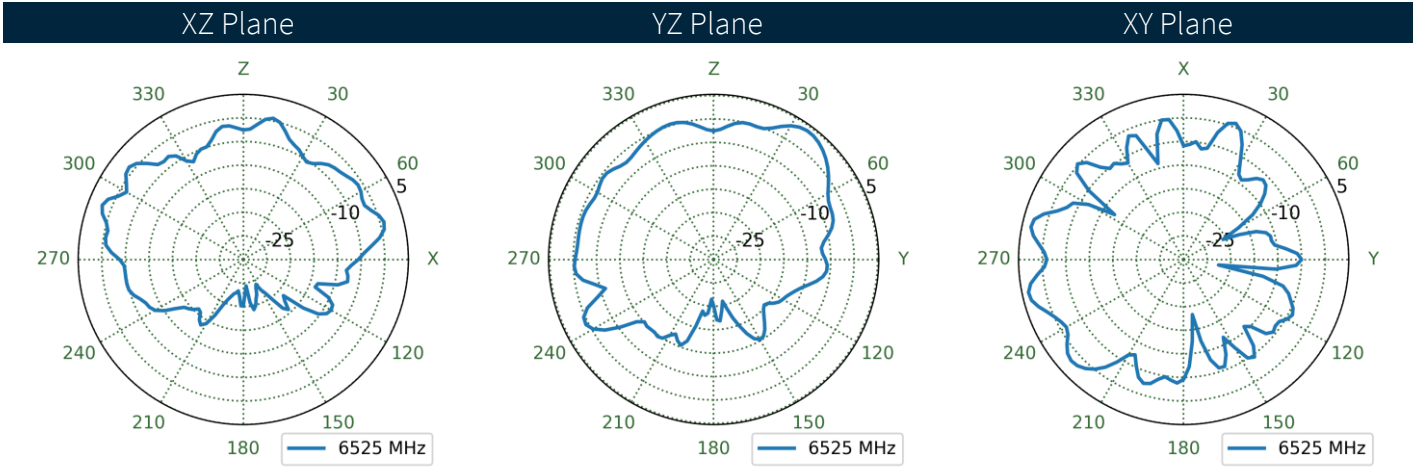
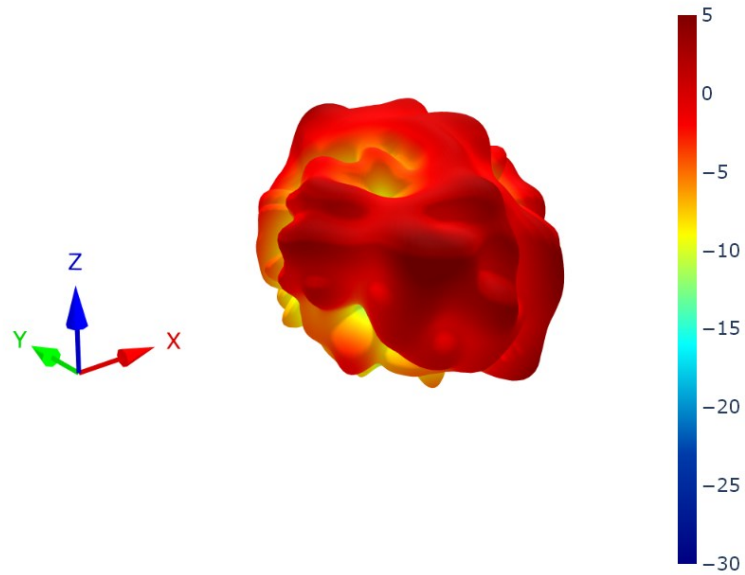

8.125 Wi-Fi6 Patterns at 6525 MHz

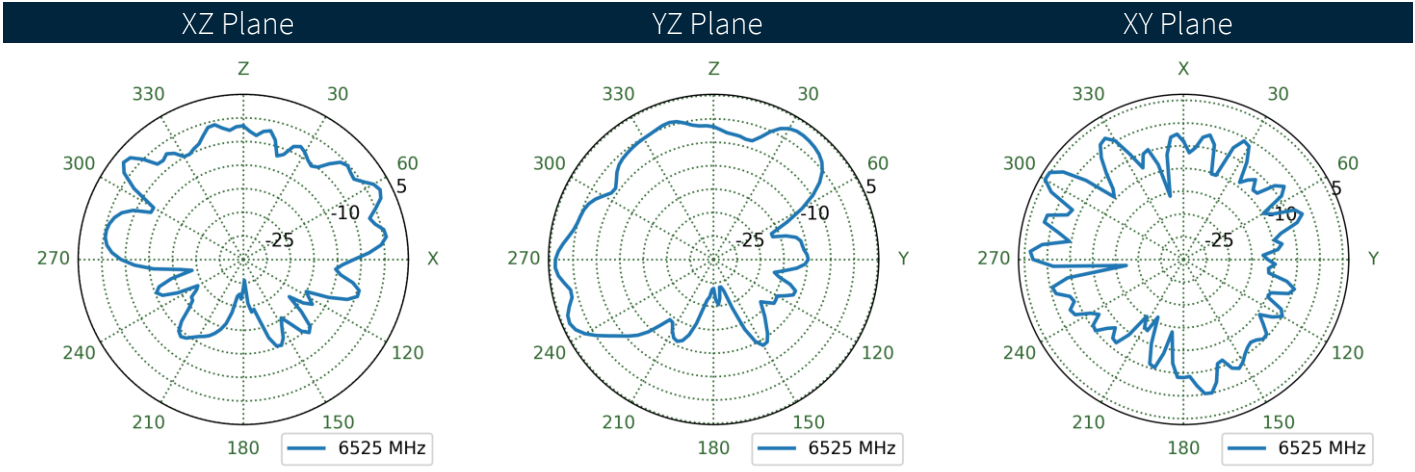
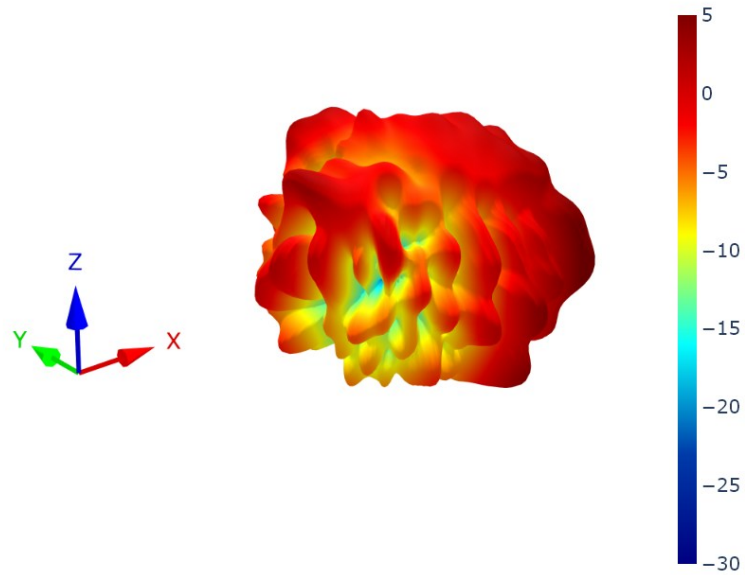

Changelog for the datasheet

SPE-24-8-195 - MAX1016.W.001

Revision: A (Original First Release)

Date: 2024-08-19

Notes: Initial Release

Author: Gary West

Previous Revisions



www.taoglas.com



X-ON Electronics

Largest Supplier of Electrical and Electronic Components

Click to view similar products for [Antennas](#) category:

Click to view products by [Taoglas](#) manufacturer:

Other Similar products are found below :

[930-033-R](#) [108-00014-50](#) [66089-2406](#) [A09-F8NF-M](#) [A09-F5NF-M](#) [RGFRA1903041A1T](#) [W1049B090](#) [WTL2449CQ1-FRSMM](#) [CPL9C](#)
[0600-00060](#) [PAL90209H-FNF](#) [GD53-25](#) [S9025PLSMF](#) [GPSCPMM00](#) [ANTDOM-05-01-WPM](#) [ANT-WP868SMA-Y](#) [CBNC58](#) [ABFT](#)
[LP800NMOW](#) [NMOQ88C](#) [NMOQB](#) [NMOQC](#) [ANT-GSMGPSPUKS](#) [60210](#) [60140](#) [ANT-8WPIG-UFL](#) [ANT-GPSPUKS](#) [A21H0](#) [29000863](#)
[29000848](#) [955179003](#) [RFANT2012090A0T](#) [RGFRA3216110A5T](#) [22100003](#) [DL-T022-2.4G](#) [DL-T023-4G](#) [T1-915M](#) [DL-T021-2.4GW](#) [DL-](#)
[T021-2.4G](#) [KH-IPEX-1.13](#) [BWGNXCX16-6B1Y2L120](#) [BWGNXCX15-15B1Y4L120](#) [DL-T023-4GW](#) [DL-J020-433M](#) [J008-GSM](#)
[3N0401LG-021](#) [KHA\(RG1.13\)-TX90B-IPEX](#) [KH-GPS181804-WY](#) [KHA\(RG1.13\)-TX80B-IPEX](#) [TX5800-JZ-5](#)