

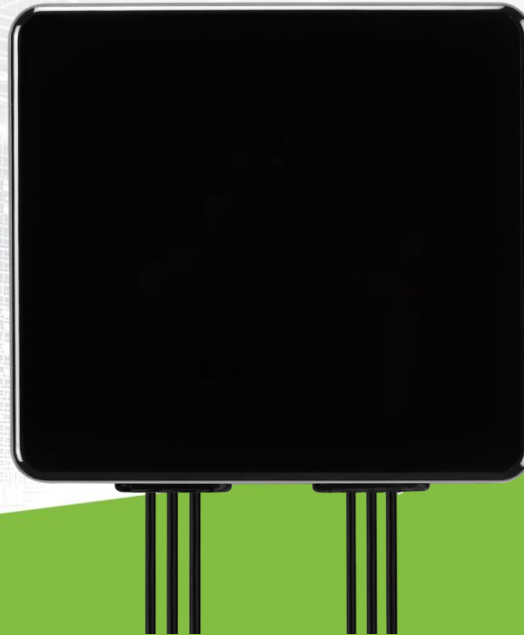

TAOGLAS®



Datasheet

Guardian

Part No:
MA996.A.003

Description

6in1 Guardian - 4*5G/4G MIMO and 2*Wi-Fi MIMO

Features:

Low-profile Housing with Wall Mount
4* 5G/4G MIMO covering 698-6000MHz
2* Wi-Fi MIMO covering 2.4/5.8/7.125GHz
Cellular fallback to 3G and 2G
IP67 Waterproof Enclosure
Dims: 146.05mm * 136.05mm * 20mm
Cables: 2m Low Loss TGC-302
Connectors: Cellular - SMA(M) / Wi-Fi RP-SMA(M)
Custom Cables and Connectors Available
RoHS & Reach Compliant

1.	Introduction	3
2.	Specification	5
3.	Mechanical Drawing (Units: mm)	8
4.	Antenna Characteristics	9
5.	Radiation Patterns	16
6.	Packaging	75
<hr/>		
	Changelog	76

Taoglas makes no warranties based on the accuracy or completeness of the contents of this document and reserves the right to make changes to specifications and product descriptions at any time without notice. Taoglas reserves all rights to this document and the information contained herein. Reproduction, use or disclosure to third parties without express permission is strictly prohibited.

Ireland & USA
ISO 9001:2015
Certified



Taiwan
ISO 9001:2015
Certified



1. Introduction



The Taoglas MA996 Guardian Series has been designed to be the smallest, high-performance combination panel antenna in the world. The heavy-duty, IP67 rated, external enclosure combines all 6 antenna elements in a low profile, compact form. The Guardian combines 4x 5G/4G Cellular antennas and 2x Wi-Fi 6 antennas making it compatible with the next generation of modules and routers.

The MA996 has been designed as a low-profile solution for IoT and Automotive applications where space is at a premium allowing it to be installed in the headliners of vehicles or on the back window of a vehicle. The Guardian series is an ideal external combination antenna solution that can be used where drilling a hole through the roof of a vehicle or a metal panel for an external antenna is not feasible or desired.

Typical applications include:

- Passenger Bus and Rail Applications
- Automotive and Heavy Equipment
- Vehicle Tracking and Telematics
- First Responder and Emergency Services
- HPUE applications such as Public Safety Communications and Critical Infrastructure and Utilities

The Guardian can be adhesive, or wall mounted as standard. The adhesive pad and wall bracket are included in the product packaging. Pole and desk mount option are also available as separate kits.

Taoglas also provides services to ensure optimum overall performance for your entire system by working closely with the customer to design in the best antenna and potential additional components for your system. 5G/4G applications demand high-speed data uplink and downlink. High efficiency and high gain MIMO antennas are necessary to achieve the required signal to noise ratio and throughput required to solve these challenges.

Taoglas also takes care to ensure high isolation between the MIMO antennas to prevent self-interference. Low loss cables are used to keep efficiency high over longer cable lengths. In contrast, smaller MIMO antennas with poor quality thin cables will have reduced efficiency and isolation, which would lead to a large drop in system throughput, increased incidences of signal drops, and may indeed not make a system connection at all.

Cable type and length, and connectors are fully customizable, and the Guardian can also be customized for other configurations up to 9-in-1 and the addition of multiband GNSS is also available. Contact your regional Taoglas customer support team for more information.

2. Specification

LTE Electrical									
Band	Frequency (MHz)	Measurement	Efficiency (%)	Average Gain (dB)	Peak Gain (dBi)	Impedance	Polarization	Radiation Pattern	Max. input power
5G NR/4G Band 71	617-698	LTE1	41.0	-3.87	1.85	50 Ω	Linear	Omni	2W
		LTE2	43.0	-3.66	1.78				
		LTE3	47.5	-3.24	4.23				
		LTE4	39.5	-4.03	2.26				
4G/3G Band 12,13,14,17,28,29	698-824	LTE1	56.2	-2.50	3.06				
		LTE2	52.7	-2.78	3.76				
		LTE3	45.8	-3.39	2.94				
		LTE4	53.0	-2.76	3.81				
4G/3G/NB-IoT/Cat M Band 5,8,18,19,20,26,27	824-960	LTE1	62.6	-2.04	3.53				
		LTE2	64.5	-1.90	3.96				
		LTE3	53.2	-2.74	3.46				
		LTE4	59.0	-2.29	5.15				
5G NR/4G Band 21,32,74,75,76	1427-1518	LTE1	71.0	-1.49	3.95				
		LTE2	58.3	-2.34	2.63				
		LTE3	59.8	-2.23	2.49				
		LTE4	67.0	-1.74	3.66				
4G/3G Band 1,2,3,4,9,23,25,35,39, 66	1710-2200	LTE1	47.4	-3.24	2.61				
		LTE2	46.0	-3.37	2.49				
		LTE3	46.7	-3.30	3.18				
		LTE4	49.5	-3.05	3.32				
4G/3G Band 7,30,38,40,41	2300-2690	LTE1	52.6	-2.79	4.33				
		LTE2	50.4	-2.97	3.65				
		LTE3	51.7	-2.87	3.48				
		LTE4	52.9	-2.76	4.18				
5G NR/4G Band 22,42,48,77,78,79	3300-5000	LTE1	66.4	-1.78	7.26				
		LTE2	63.9	-1.95	6.95				
		LTE3	64.3	-1.92	6.21				
		LTE4	69.3	-1.59	7.42				
LTE5200/Wi-Fi5800	5150-5925	LTE1	54.5	-2.63	5.96				
		LTE2	58.9	-2.30	5.15				
		LTE3	56.1	-2.51	5.21				
		LTE4	52.1	-2.83	5.38				

5G/4G Bands						
Band Number	5GNR / FR1 / LTE / LTE-Advanced / WCDMA / HSPA / HSPA+ / TD-SCDMA					
	Uplink	Downlink	LTE1	LTE2	LTE3	LTE4
B1	1920 to 1980	2110 to 2170	✓	✓	✓	✓
B2	1850 to 1910	1930 to 1990	✓	✓	✓	✓
B3	1710 to 1785	1805 to 1880	✓	✓	✓	✓
B4	1710 to 1755	2110 to 2155	✓	✓	✓	✓
B5	824 to 849	869 to 894	✓	✓	✓	✓
B7	2500 to 2570	2620 to 2690	✓	✓	✓	✓
B8	880 to 915	925 to 960	✓	✓	✓	✓
B9*	1749.9 to 1784.9	1844.9 to 1879.9	✓	✓	✓	✓
B11	1427.9 to 1447.9	1475.9 to 1495.9	✓	✓	✓	✓
B12	699 to 716	729 to 746	✓	✓	✓	✓
B13	777 to 787	746 to 756	✓	✓	✓	✓
B14	788 to 798	758 to 768	✓	✓	✓	✓
B17	704 to 716	734 to 746	✓	✓	✓	✓
B18	815 to 830	860 to 875	✓	✓	✓	✓
B19	830 to 845	875 to 890	✓	✓	✓	✓
B20	832 to 862	791 to 821	✓	✓	✓	✓
B21	1447.9 to 1462.9	1495.9 to 1510.9	✓	✓	✓	✓
B22*	3410 to 3490	3510 to 3590	✓	✓	✓	✓
B23*	2000 to 2020	2180 to 2200	✓	✓	✓	✓
B24	1626.5 to 1660.5	1525 to 1559	✓	✓	✓	✓
B25	1850 to 1915	1930 to 1995	✓	✓	✓	✓
B26	814 to 849	859 to 894	✓	✓	✓	✓
B27*	807 to 824	852 to 869	✓	✓	✓	✓
B28	703 to 748	758 to 803	✓	✓	✓	✓
B29		717 to 728	✓	✓	✓	✓
B30	2305 to 2315	2350 to 2360	✓	✓	✓	✓
B31	452.5 to 457.5	462.5 to 467.5	✗	✗	✗	✗
B32		1452 to 1496	✓	✓	✓	✓
B34		2010 to 2025	✓	✓	✓	✓
B35		1850 to 1910	✓	✓	✓	✓
B36		1930 to 1990	✓	✓	✓	✓
B37		1910 to 1930	✓	✓	✓	✓
B38		2570 to 2620	✓	✓	✓	✓
B39		1880 to 1920	✓	✓	✓	✓
B40		2300 to 2400	✓	✓	✓	✓
B41		2496 to 2690	✓	✓	✓	✓
B42		3400 to 3600	✓	✓	✓	✓
B43		3600 to 3800	✓	✓	✓	✓
B45		1447 to 1467	✓	✓	✓	✓
B46		5150 to 5925	✓	✓	✓	✓
B47		5855 to 5925	✓	✓	✓	✓
B48		3550 to 3700	✓	✓	✓	✓
B49		3550 to 3700	✓	✓	✓	✓
B50		1432 to 1517	✓	✓	✓	✓
B51		1427 to 1432	✓	✓	✓	✓
B52		3300 to 3400	✓	✓	✓	✓
B53		2483.5 to 2495	✓	✓	✓	✓
B65	1920 to 2010	2110 to 2200	✓	✓	✓	✓
B66	1710 to 1780	2110 to 2200	✓	✓	✓	✓
B68	698 to 728	753 to 783	✓	✓	✓	✓
B69		2570 to 2620	✓	✓	✓	✓
B70	1695 to 1710	1995 to 2020	✓	✓	✓	✓
B71	663 to 698	617 to 652	✓	✓	✓	✓
B72	451 to 456	461 to 466	✗	✗	✗	✗
B73	450 to 455	460 to 465	✗	✗	✗	✗
B74	1427 to 1470	1475 to 1518	✓	✓	✓	✓
B75		1432 to 1517	✓	✓	✓	✓
B76		1427 to 1432	✓	✓	✓	✓
B77		3300 to 4200	✓	✓	✓	✓
B78		3300 to 3800	✓	✓	✓	✓
B79		4400 to 5000	✓	✓	✓	✓
B85	698 to 716	728 to 746	✓	✓	✓	✓
B87	410 to 415	420 to 425	✗	✗	✗	✗
B88	412 to 417	422 to 427	✗	✗	✗	✗

Wi-Fi Electrical									
Band	Frequency (MHz)	Measurement	Efficiency (%)	Average Gain (dB)	Peak Gain (dBi)	Impedance	Polarization	Radiation Pattern	Max. input power
Wi-Fi - 2GHz	2400-2500	Wi-Fi1	47.1	-3.27	2.45	50 Ω	Linear	Omni	2W
		Wi-Fi2	43.1	-3.66	2.74				
Wi-Fi - 5GHz	5150-5850	Wi-Fi1	61.0	-2.14	5.00				
		Wi-Fi2	58.5	-2.33	4.70				
Wi-Fi - 6GHz	5925-7125	Wi-Fi1	54.7	-2.62	5.15				
		Wi-Fi2	54.7	-2.62	4.44				

Mechanical	
Dimensions	146.1 x 136.1 x 20mm
Weight	TBD
Material	ASA
Connector	Wi-Fi – SMA(M) – RP LTE – SMA(M)
Cable	Wi-Fi – TGC-302 LTE – TGC-302

Environmental	
Temperature Range	-40°C to 85°C
Relative Humidity	Non-condensing 65°C 95% RH
RoHs & REACH Compliant	Yes

3. Mechanical Drawing (Units: mm)

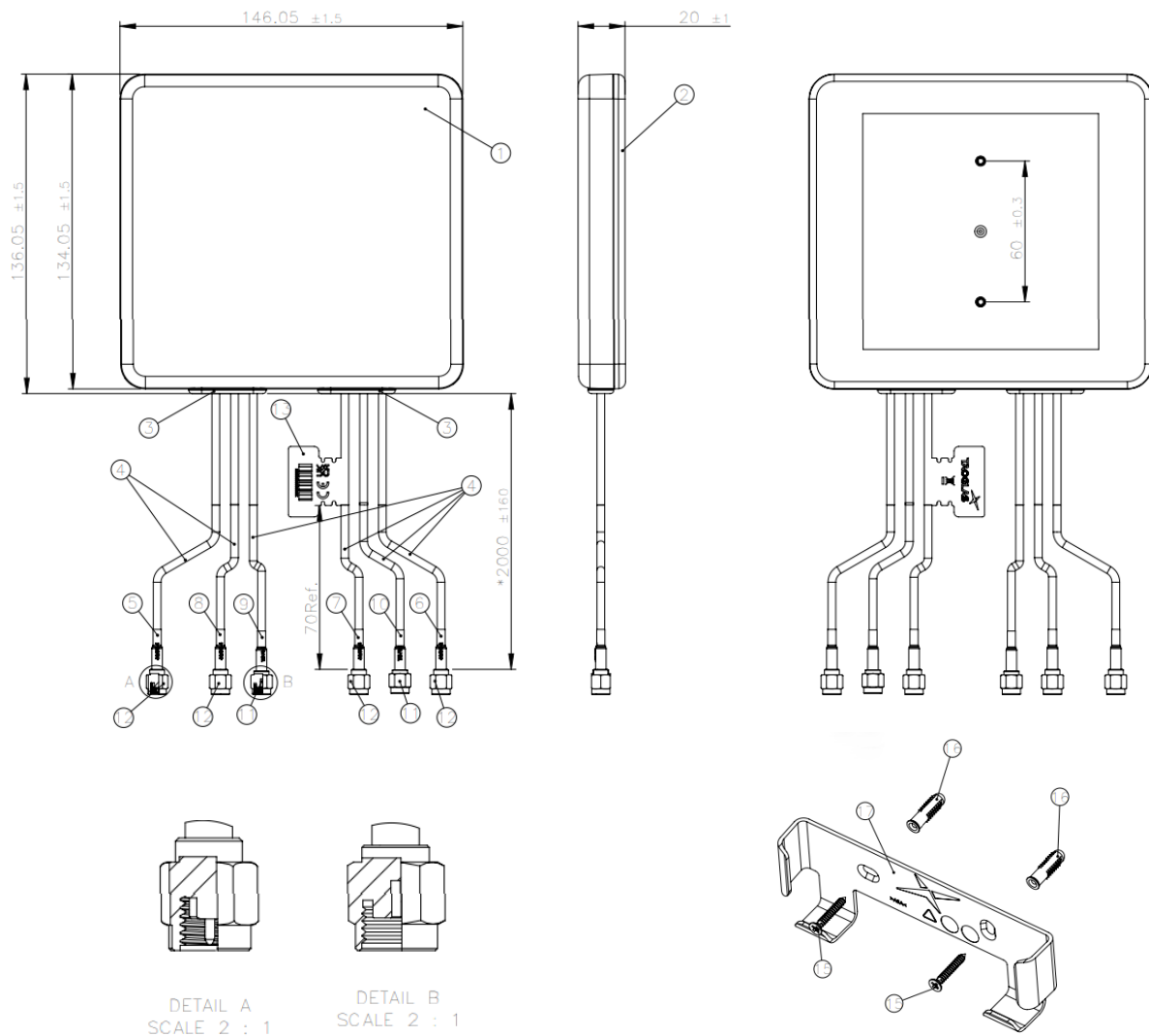

DETAIL A
SCALE 2 : 1

DETAIL B
SCALE 2 : 1

	Name	Material	Finish	Qty
1	Top Housing	ASA	Black	1
2	Bottom housing_Guardian_Black	ASA	Black	1
3	Grommet 2_Black	Silicone Rubber	Black	2
4	TGC-302 low loss coaxial cable	PVC	Black	6
5	Heat Shrink Tube(4G/5G-1)	PE	Red Tube/White Text	1
6	Heat Shrink Tube(4G/5G-2)	PE	Red Tube/White Text	1
7	Heat Shrink Tube(4G/5G-3)	PE	Red Tube/White Text	1
8	Heat Shrink Tube(4G/5G-4)	PE	Red Tube/White Text	1
9	Heat Shrink Tube (WIFI-1)	PE	Yellow tube/ Black text	1
10	Heat Shrink Tube (WIFI-2)	PE	Yellow Tube/Black Text	1
11	SMA(M)ST_RP	Brass	AU PLATING	2
12	SMA(M)ST Plug for TGC-302	Brass	Au Plated	4
13	CE,WEEE and UKCA mark logo Label	PEFA	White	1
14	Double Adhesive Foam(100x100x3.54t)	CR430543M9448HK 3.5t	Black	1
15	Tapping Screw_M3.5*25 countersunk flat	SUS304	N/A	2
16	Wall Mount Stud 6*24L	Nylon	White	2
17	Wall Mounting Bracket	ASA	Black	1

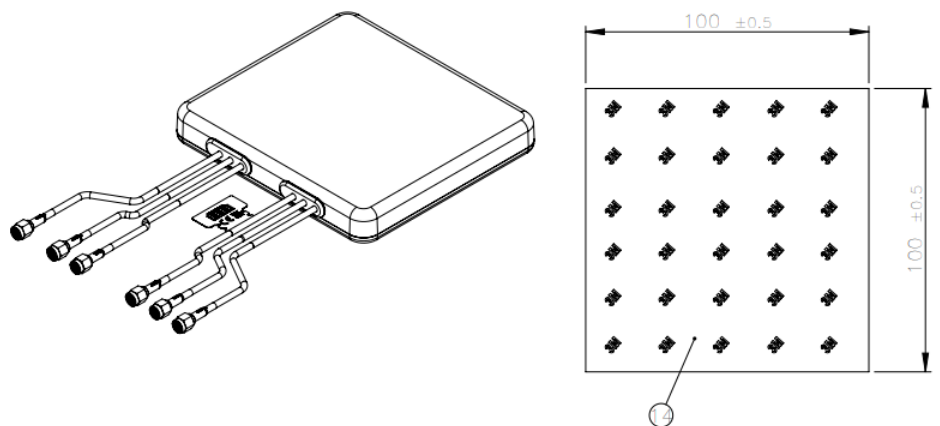

4. Antenna Characteristics

4.1 Test Setup

AUT



Vector Network Analyzer

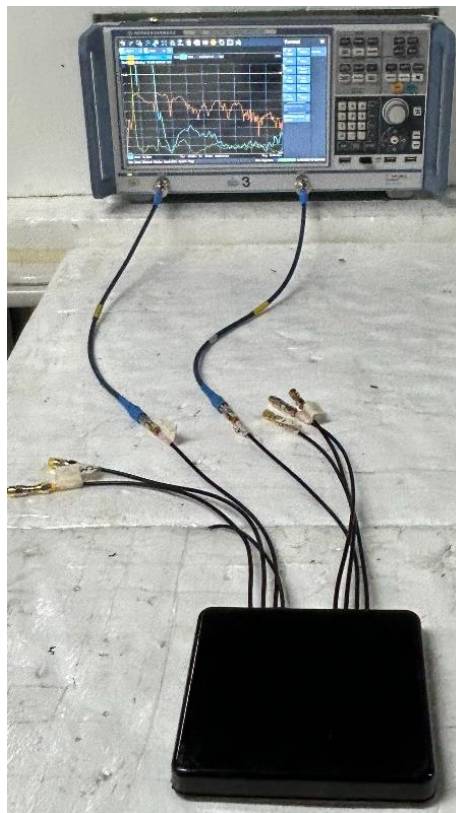

VNA Test Set-up

4.2 LTE - Return Loss

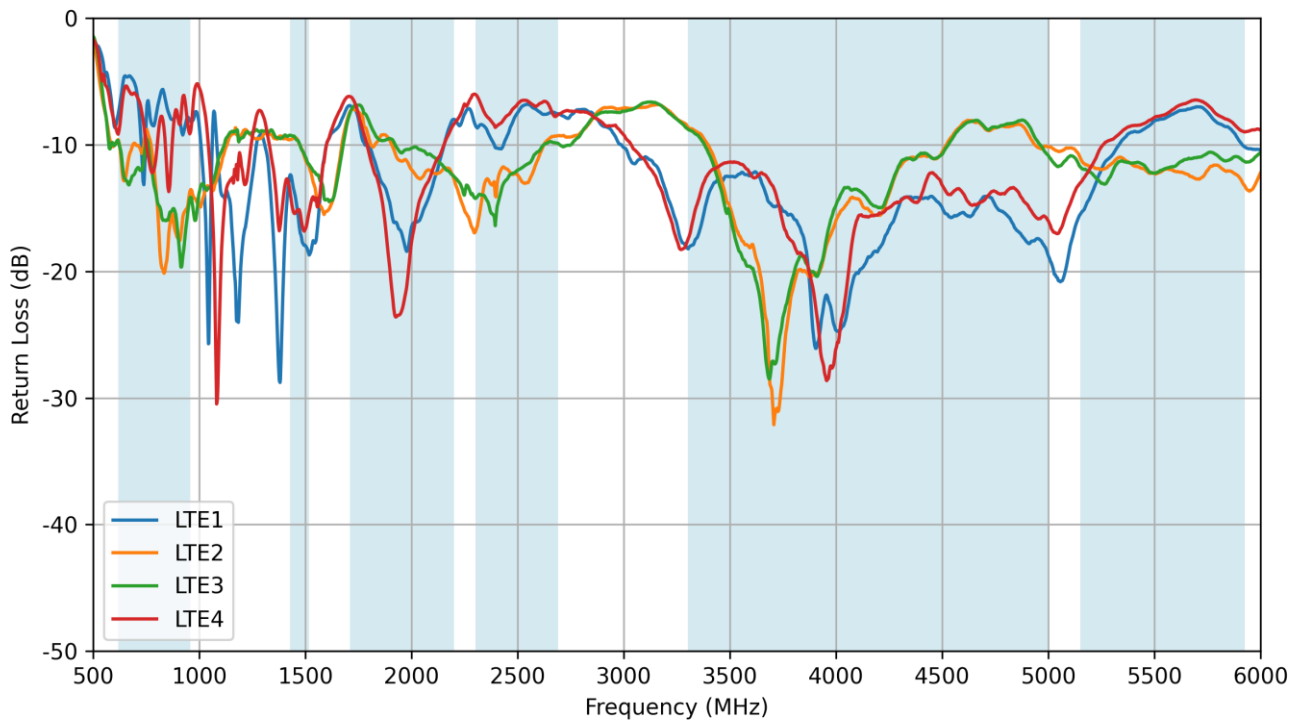

4.3 LTE - VSWR

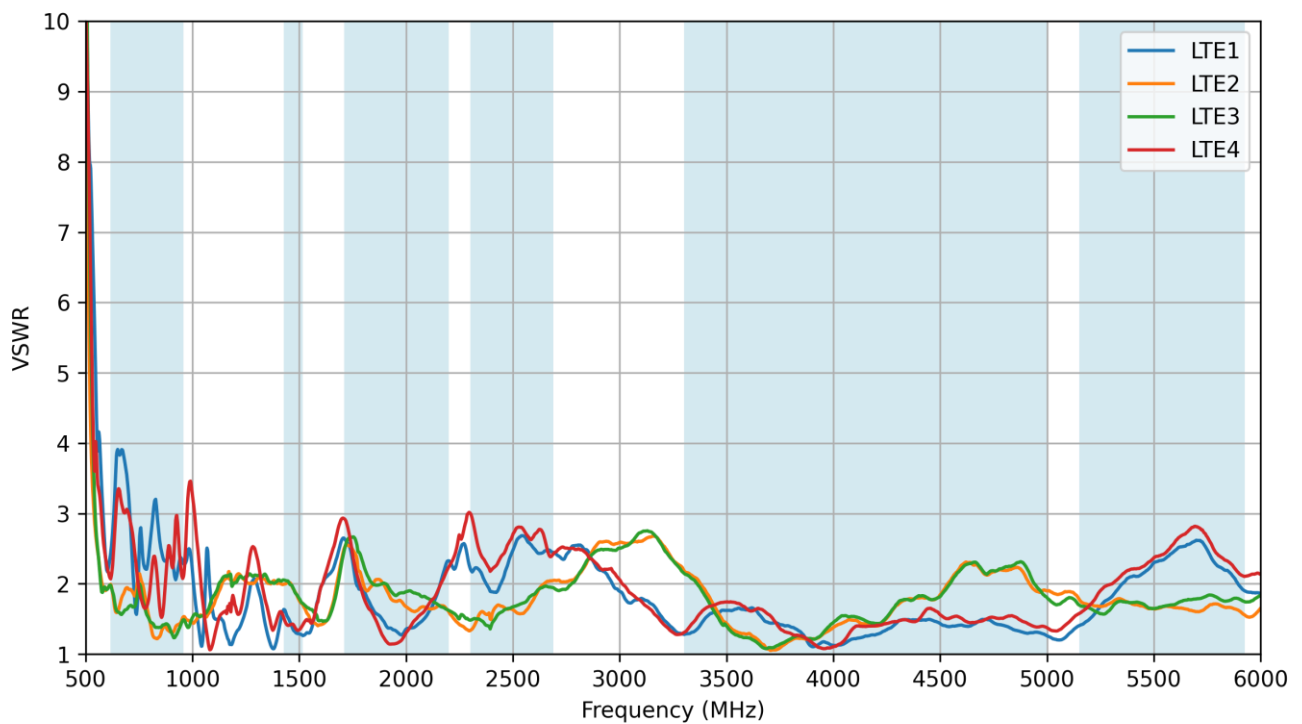

4.4 LTE - Isolation

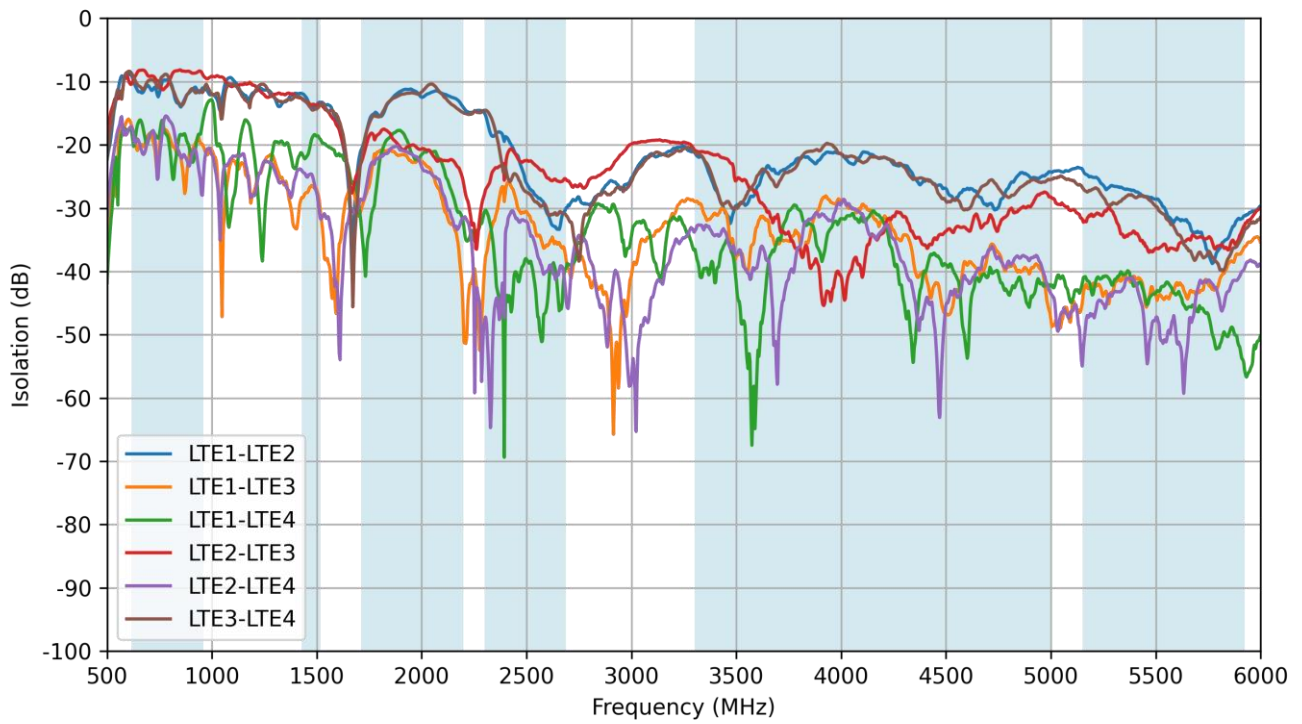

4.5 LTE - Efficiency

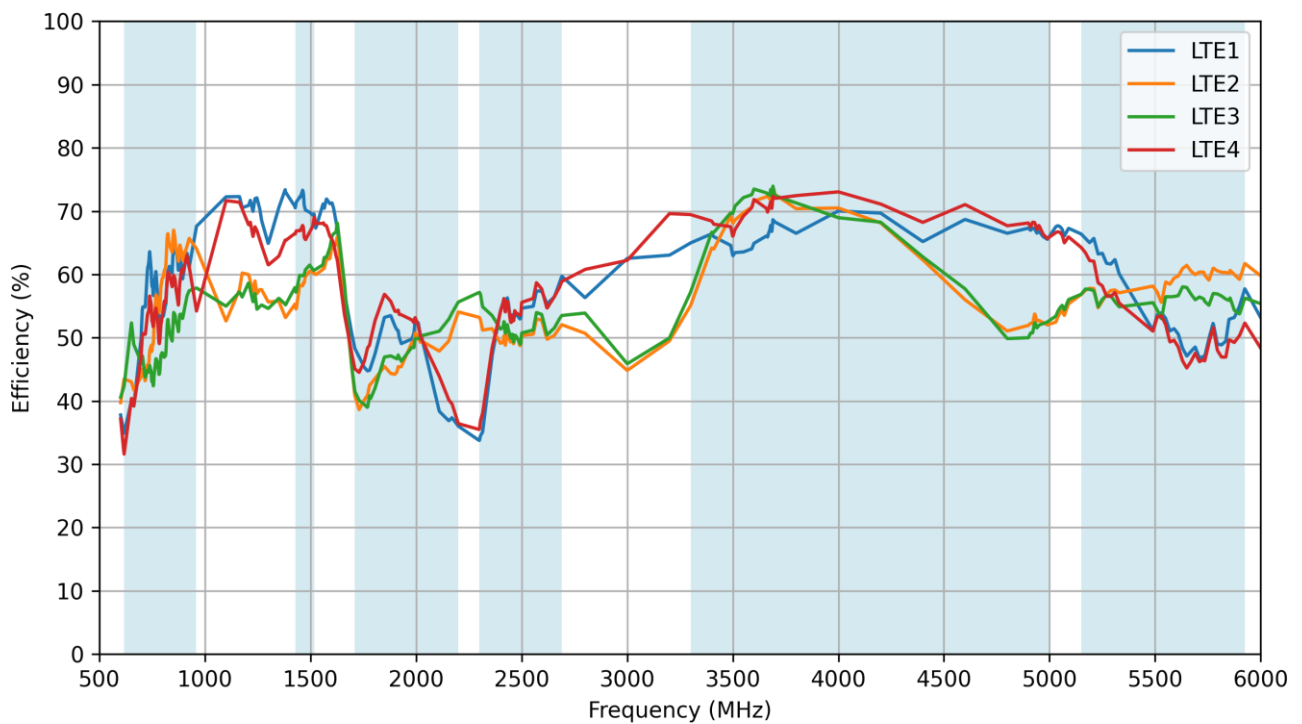

4.6 LTE - Average Gain

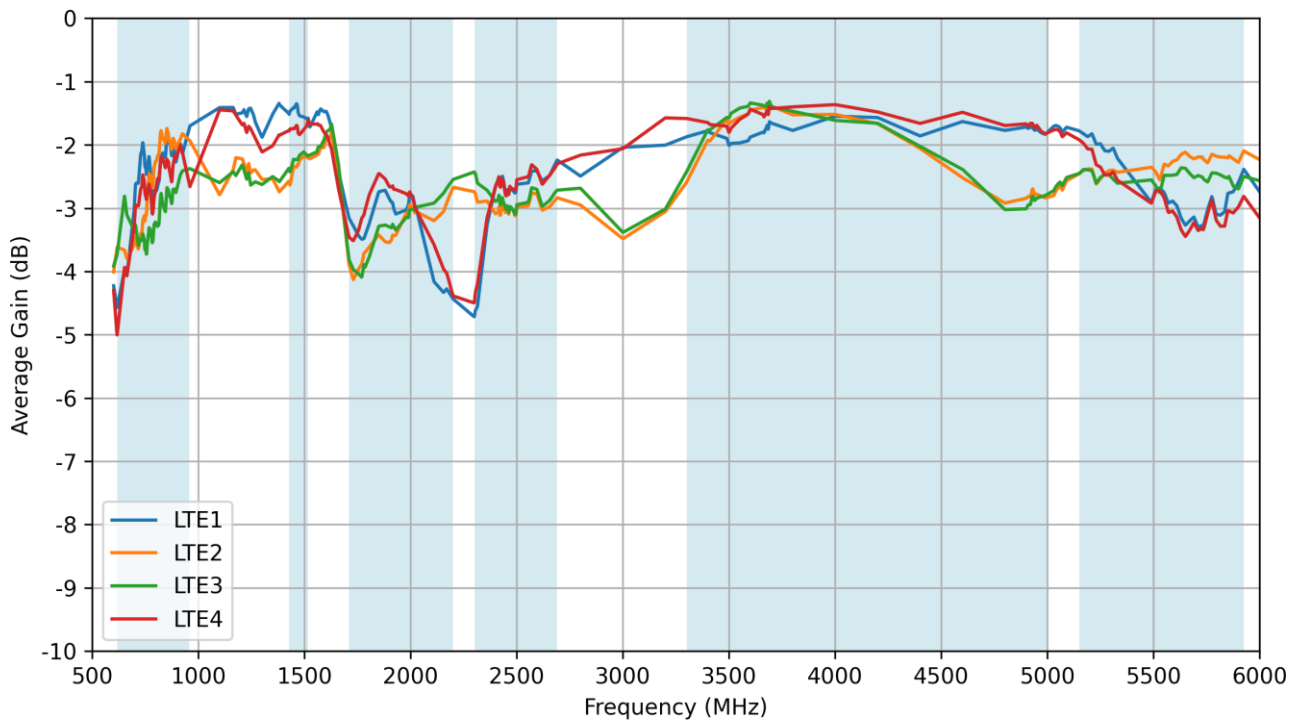

4.7 LTE - Peak Gain

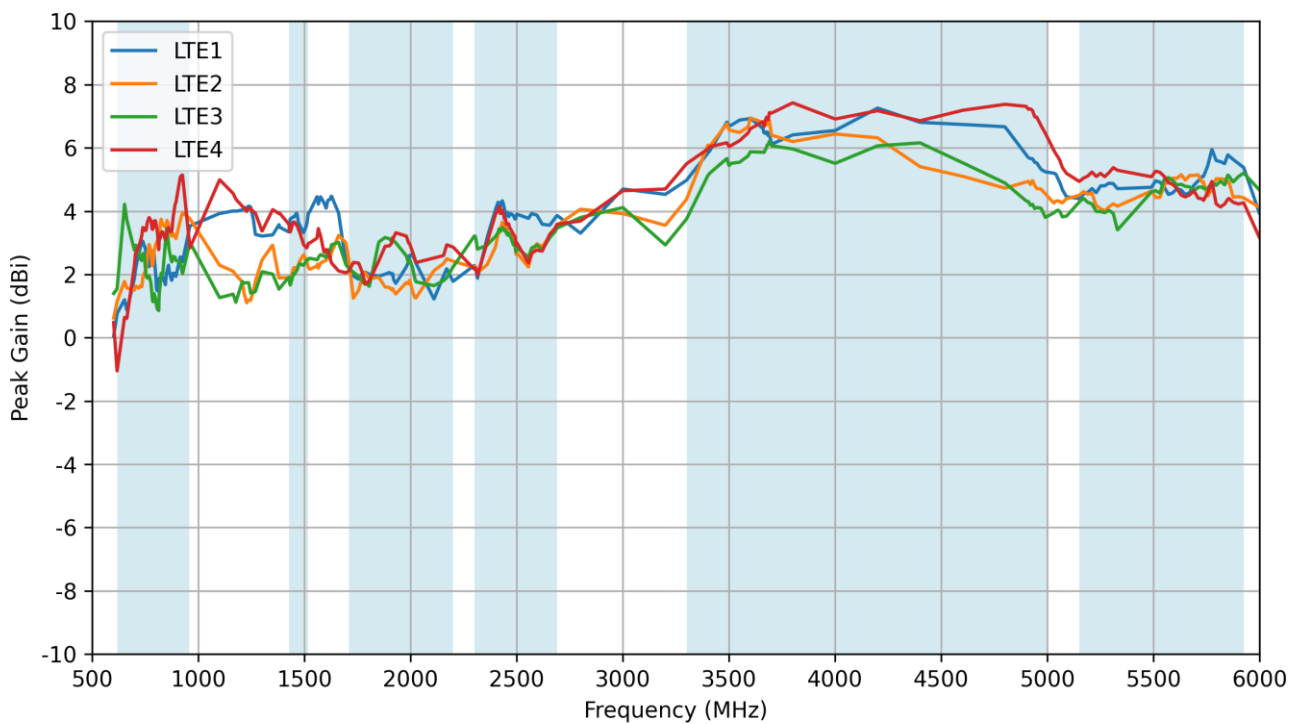

4.8 Wi-Fi - Return Loss

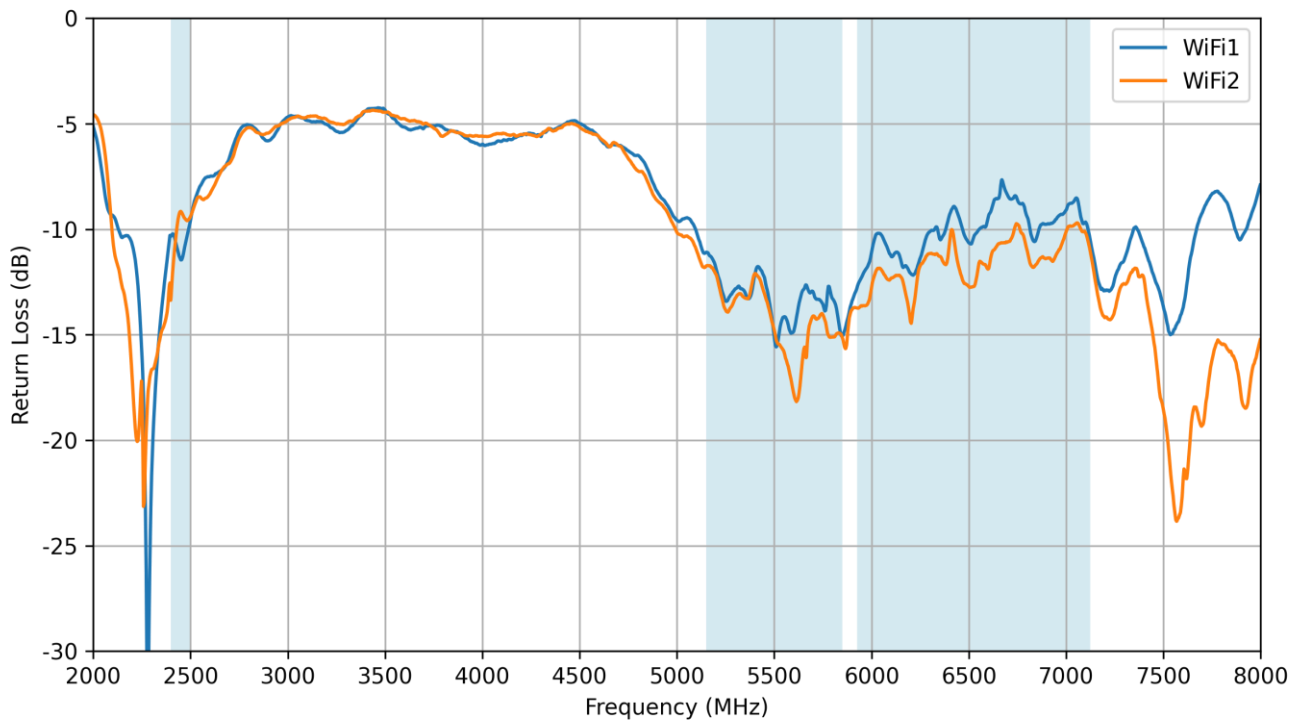

4.9 Wi-Fi - VSWR

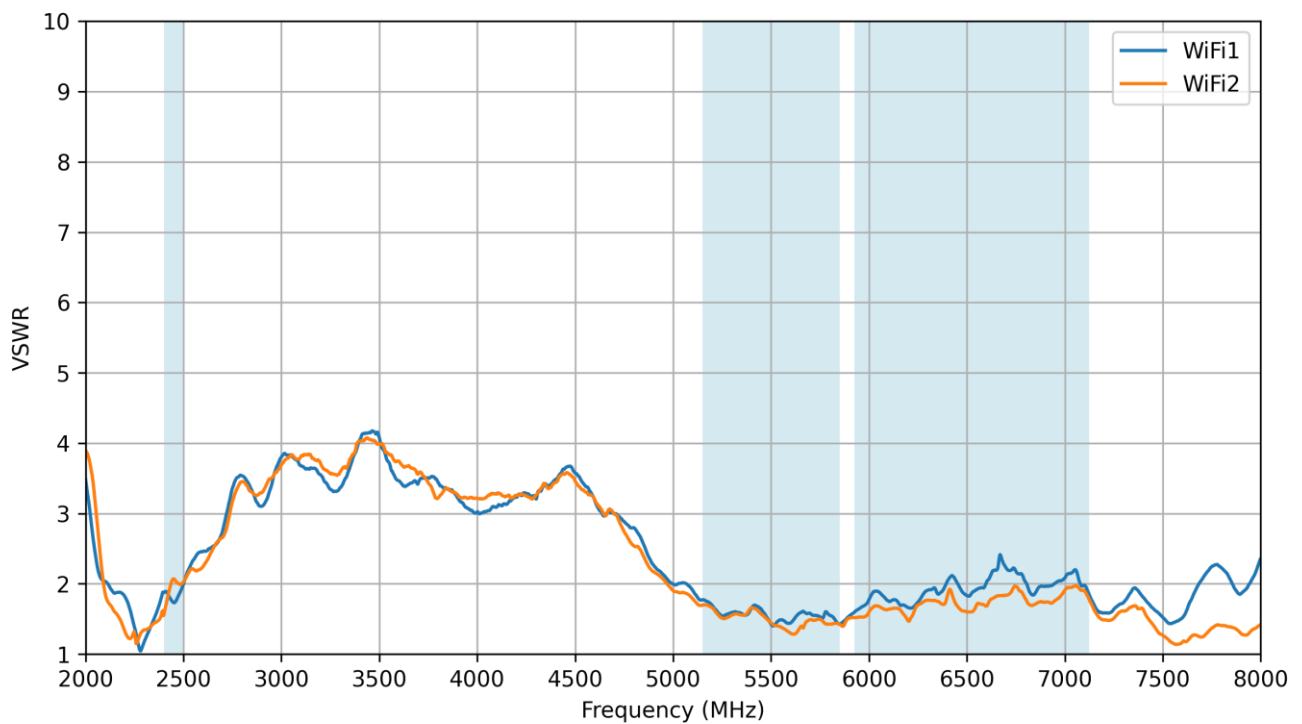

4.10 Wi-Fi - Isolation

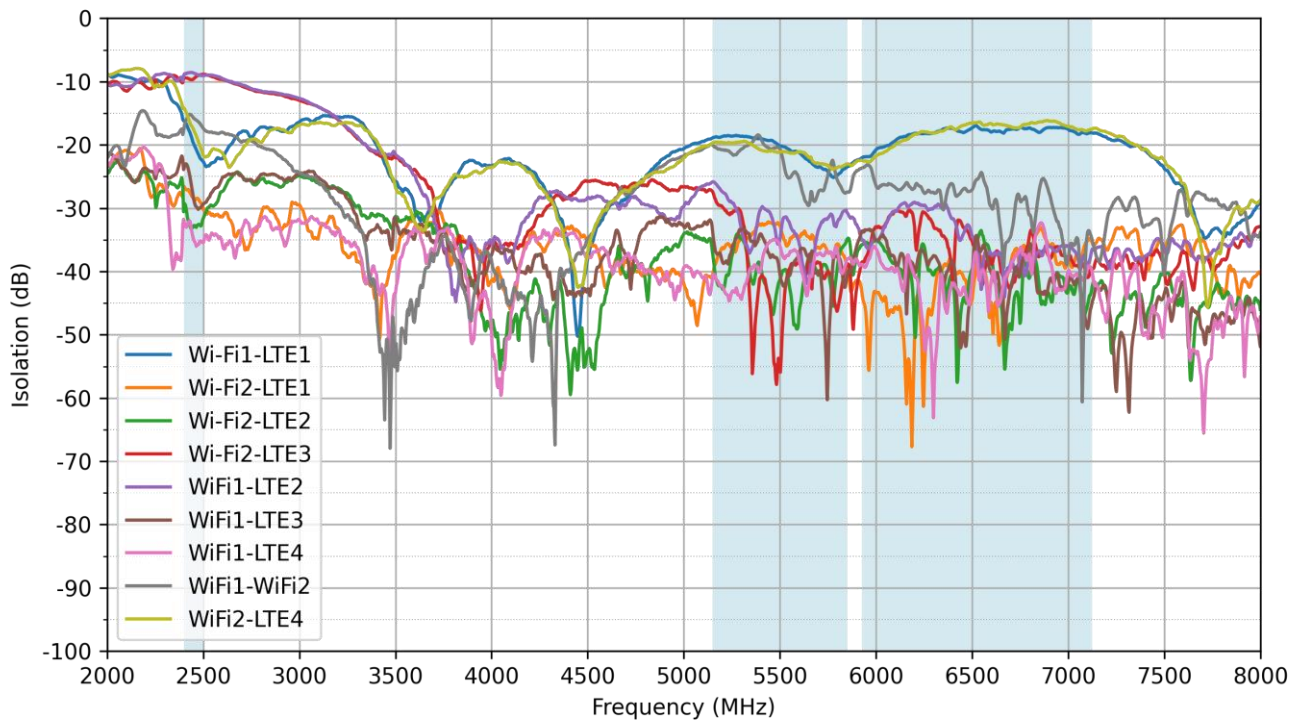

4.11 Wi-Fi - Efficiency

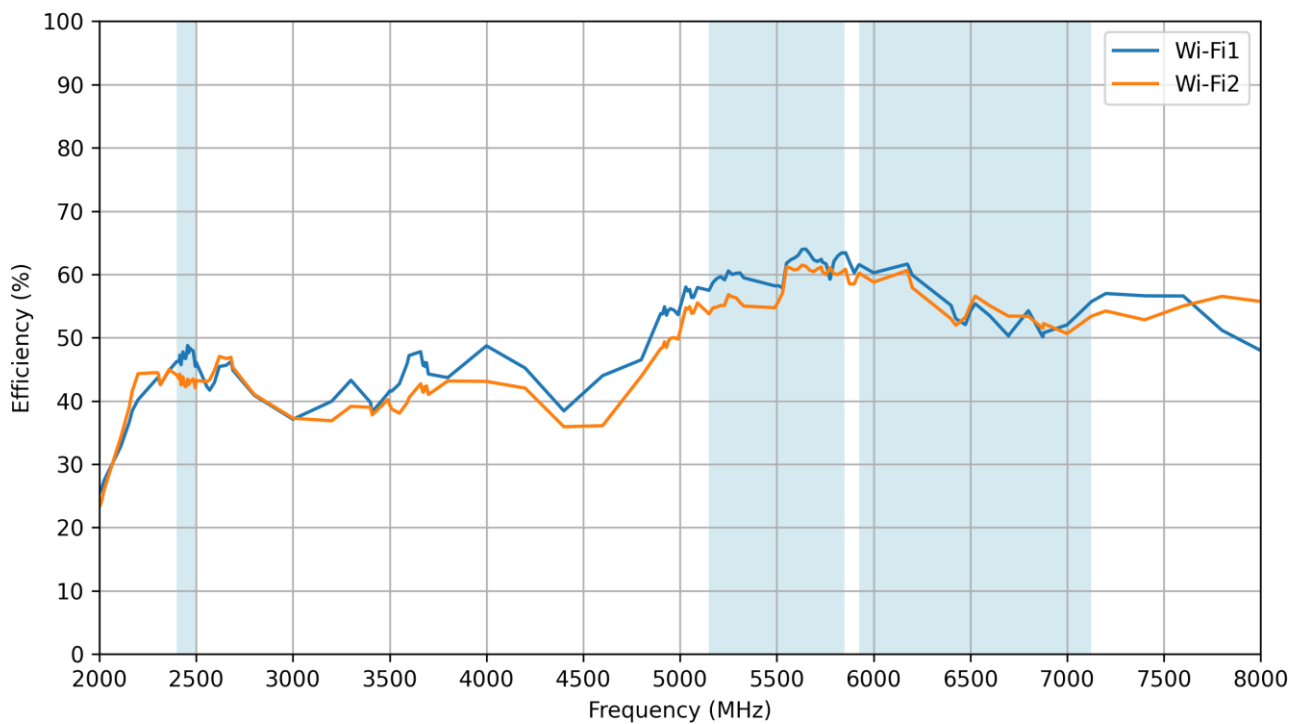

4.12 Wi-Fi - Average Gain

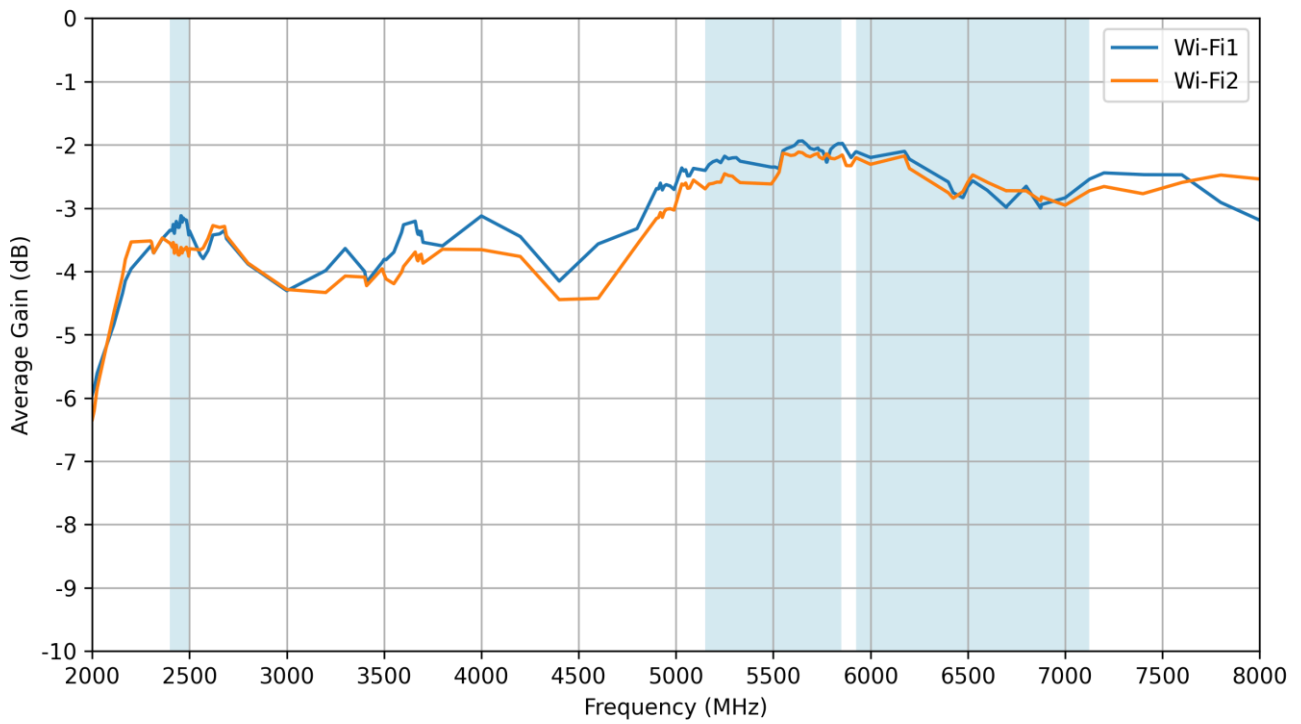

4.13 Wi-Fi - Peak Gain (Gtotal)

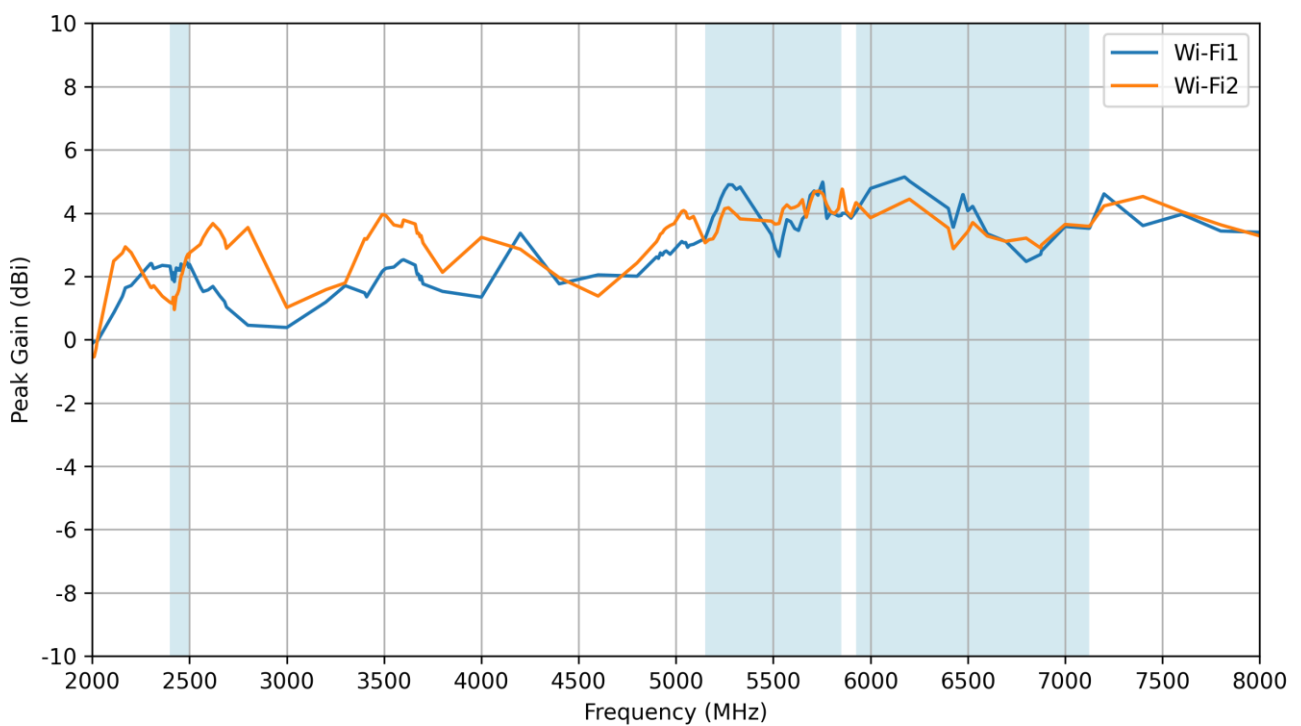

5. Radiation Patterns

5.1 Test Setup

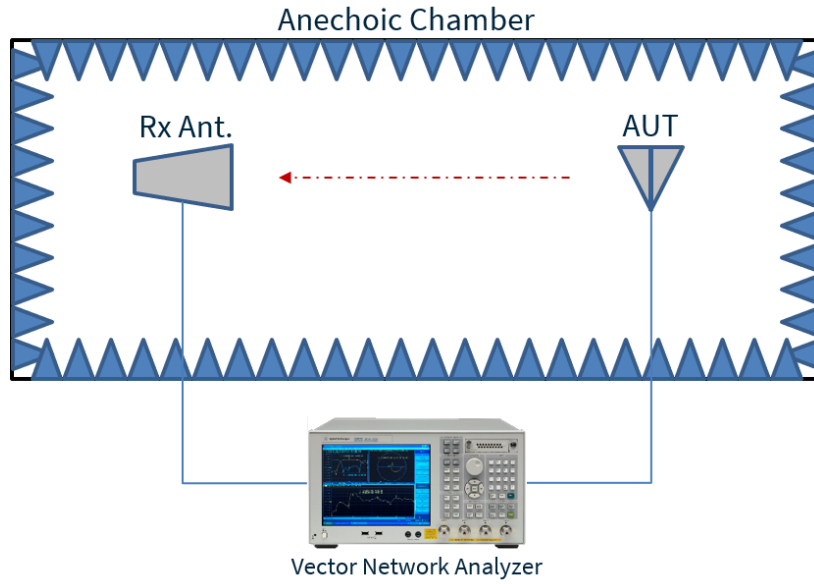

Chamber Test Set-up

5.2 LTE1 Patterns at 650 MHz

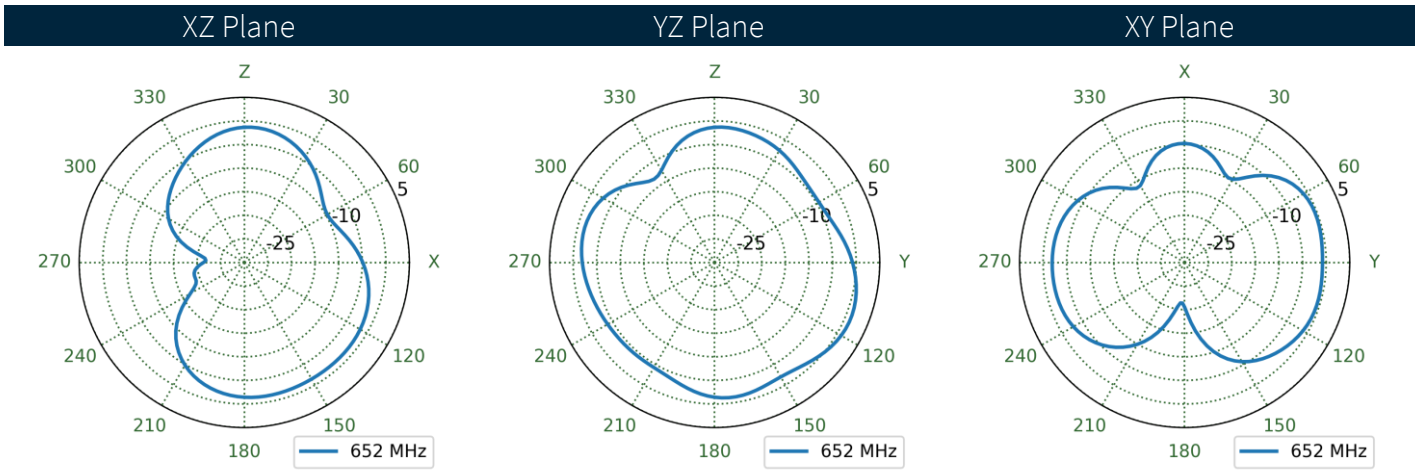
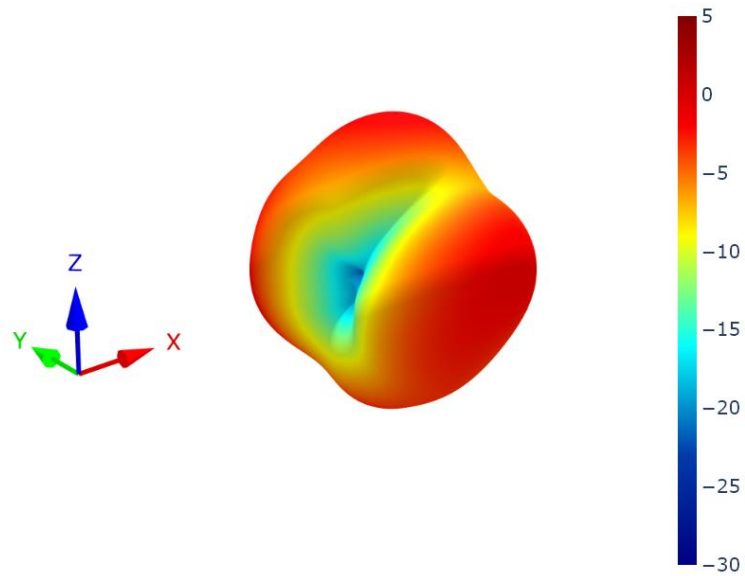

5.3 LTE2 Patterns at 650 MHz

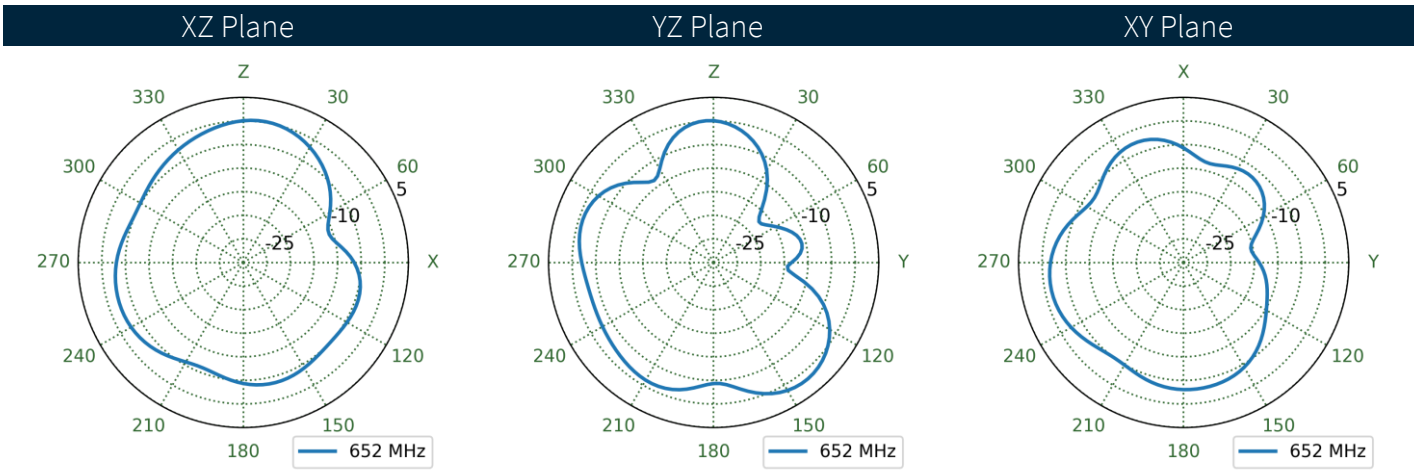
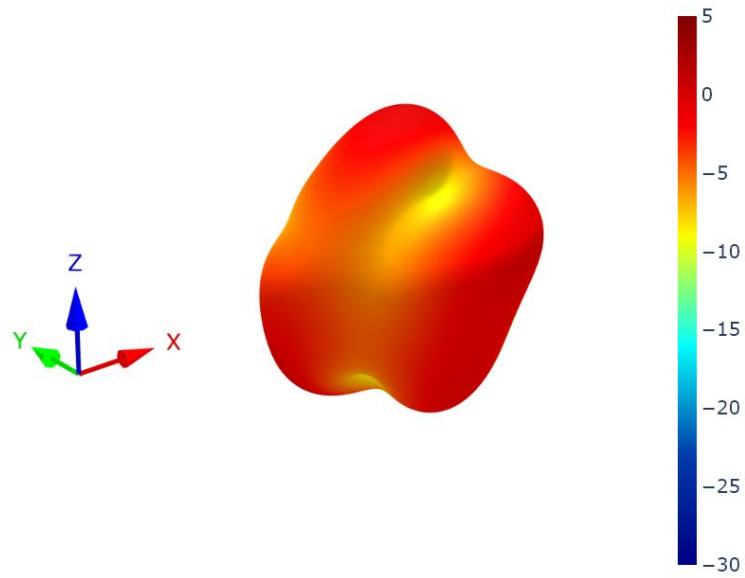

5.4 LTE3 Patterns at 650 MHz

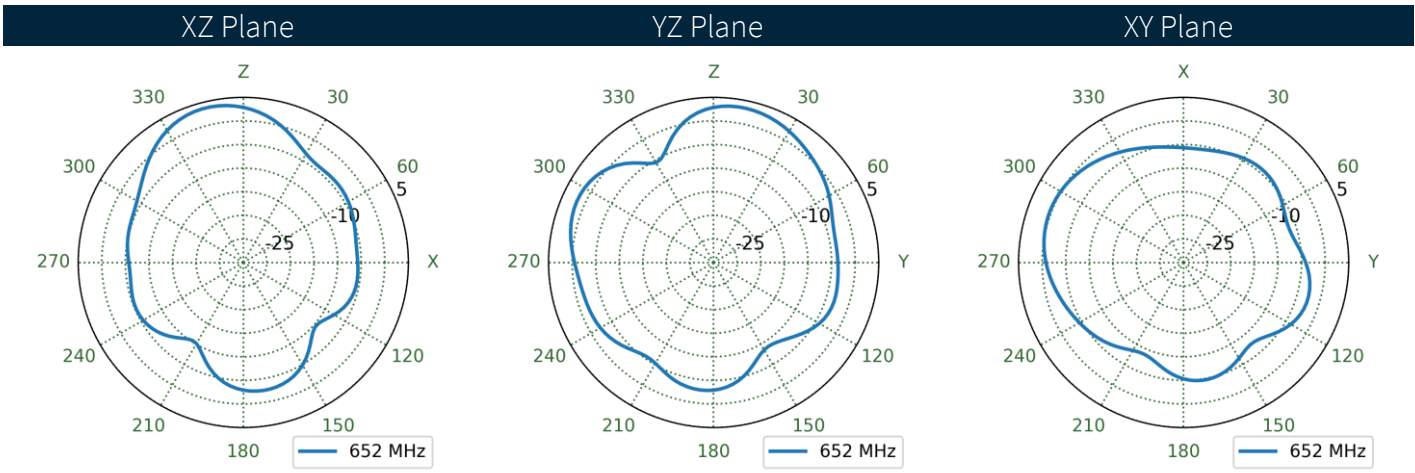
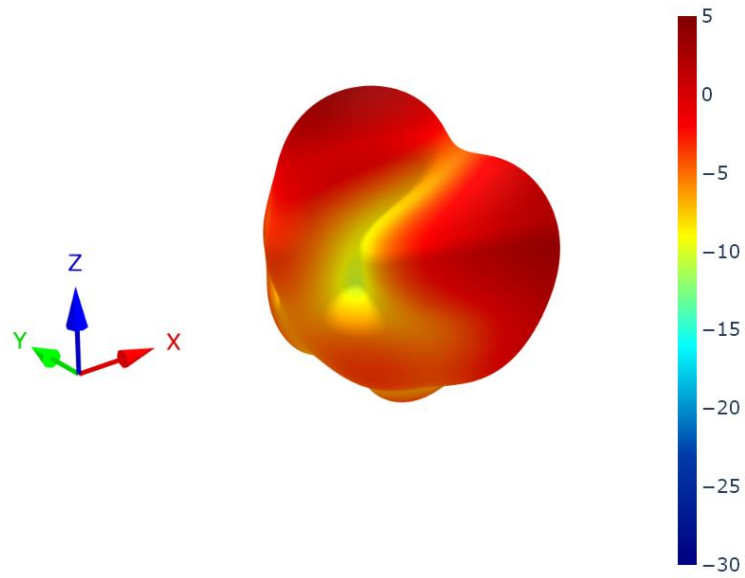

5.5 LTE4 Patterns at 650 MHz

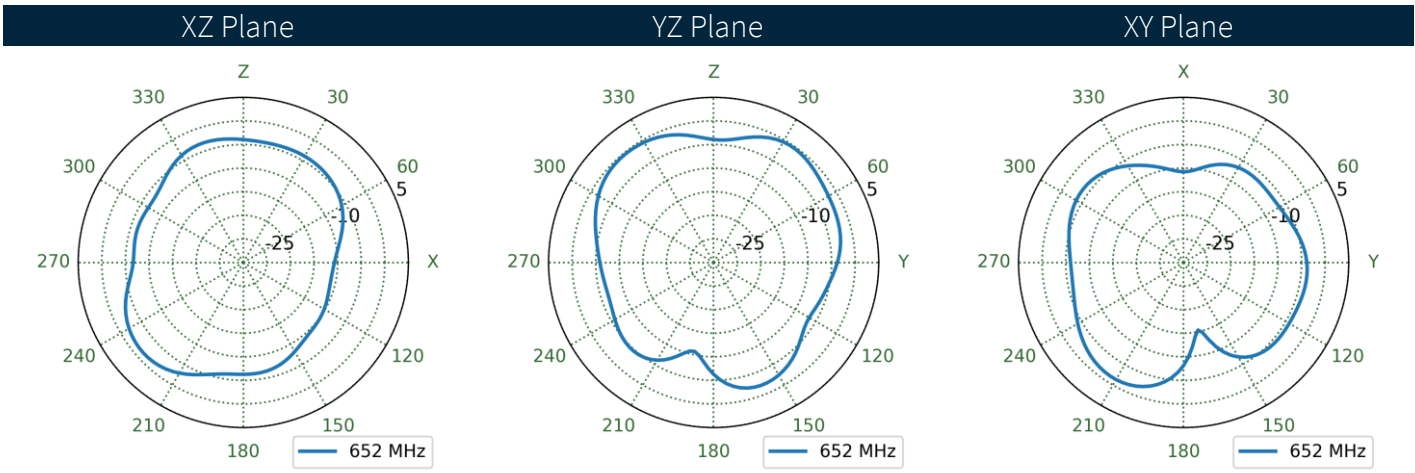
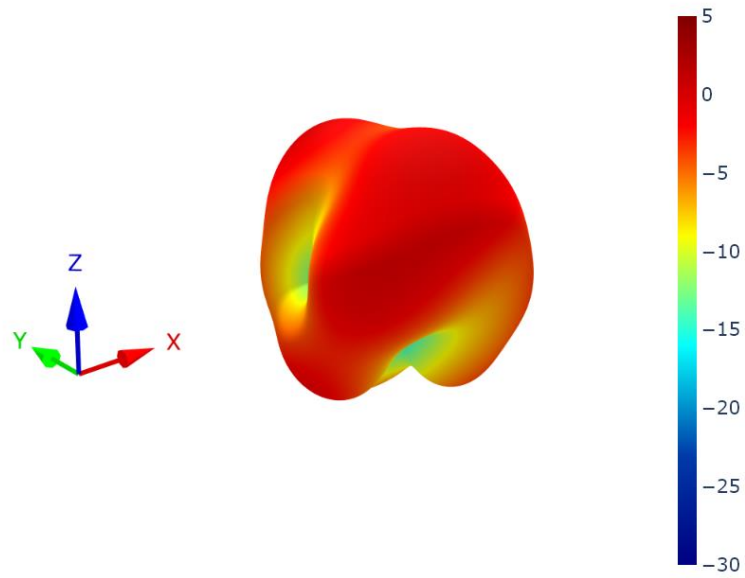

5.6 LTE1 Patterns at 750 MHz

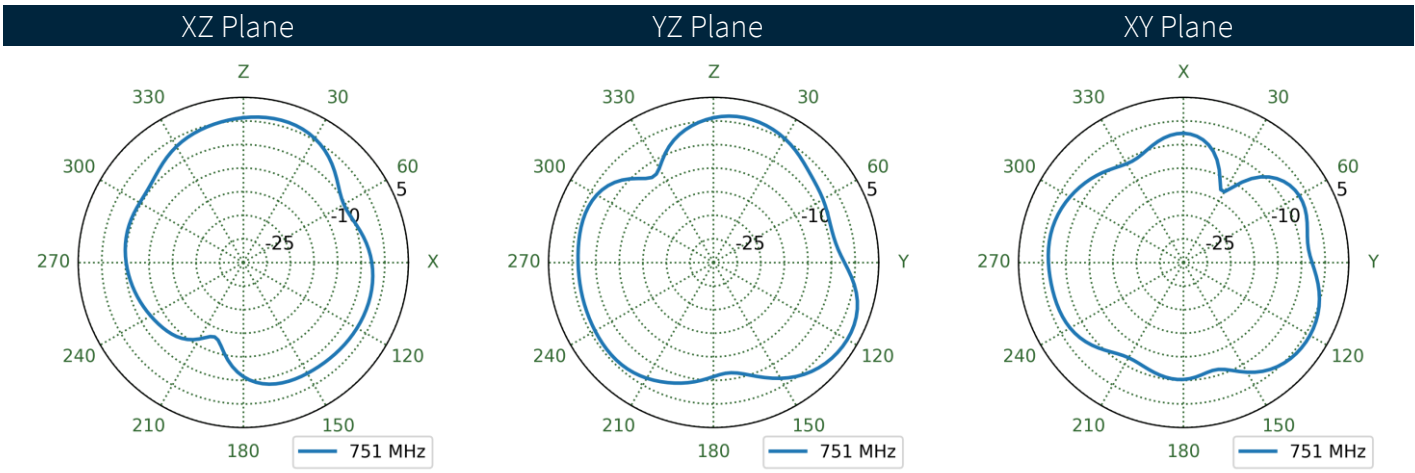
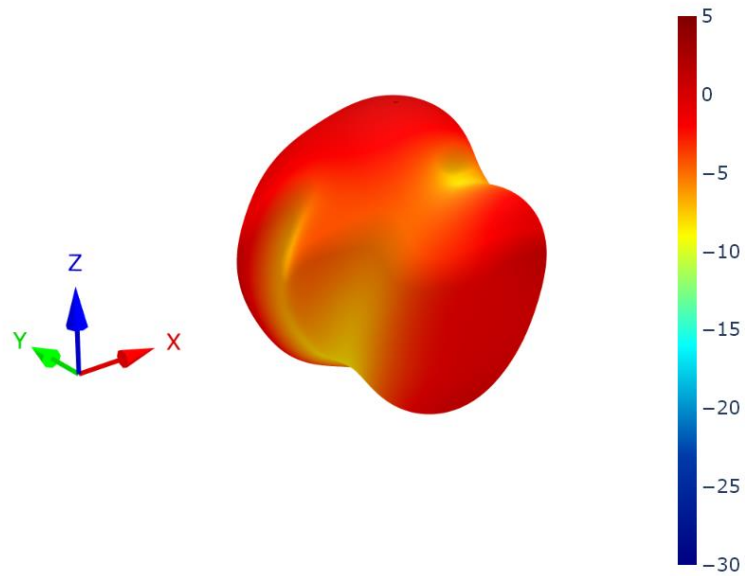

5.7 LTE2 Patterns at 750 MHz

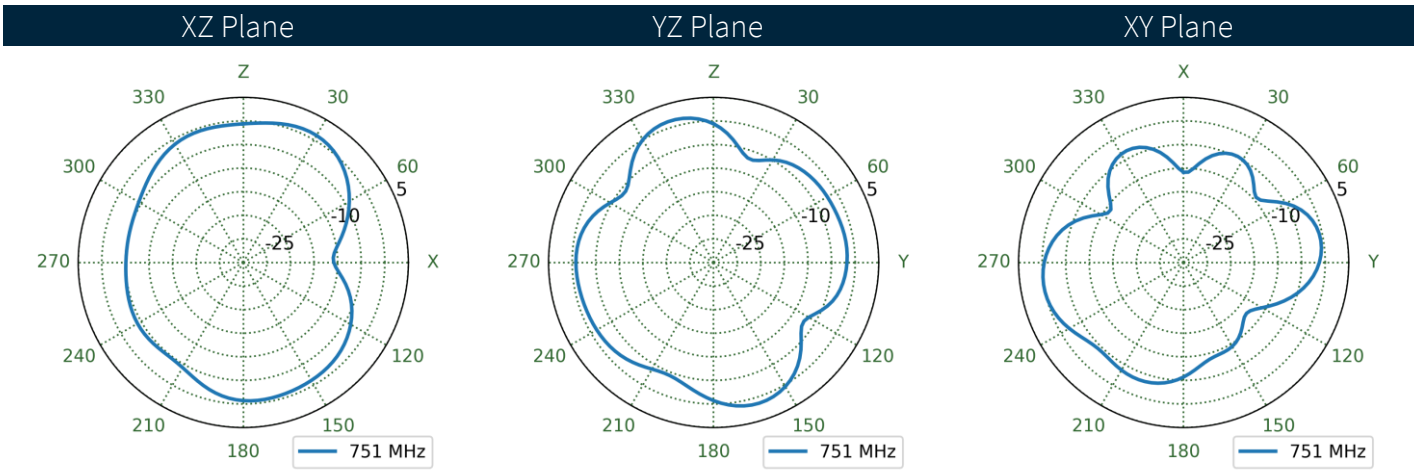
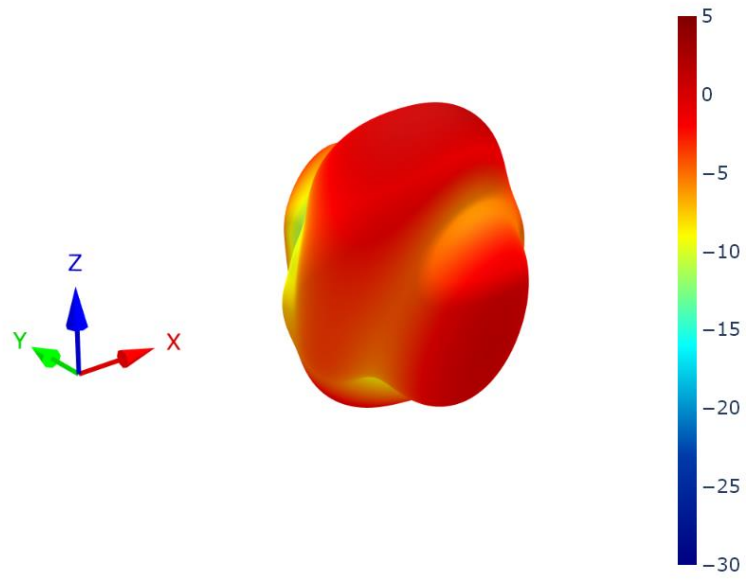

5.8 LTE3 Patterns at 750 MHz

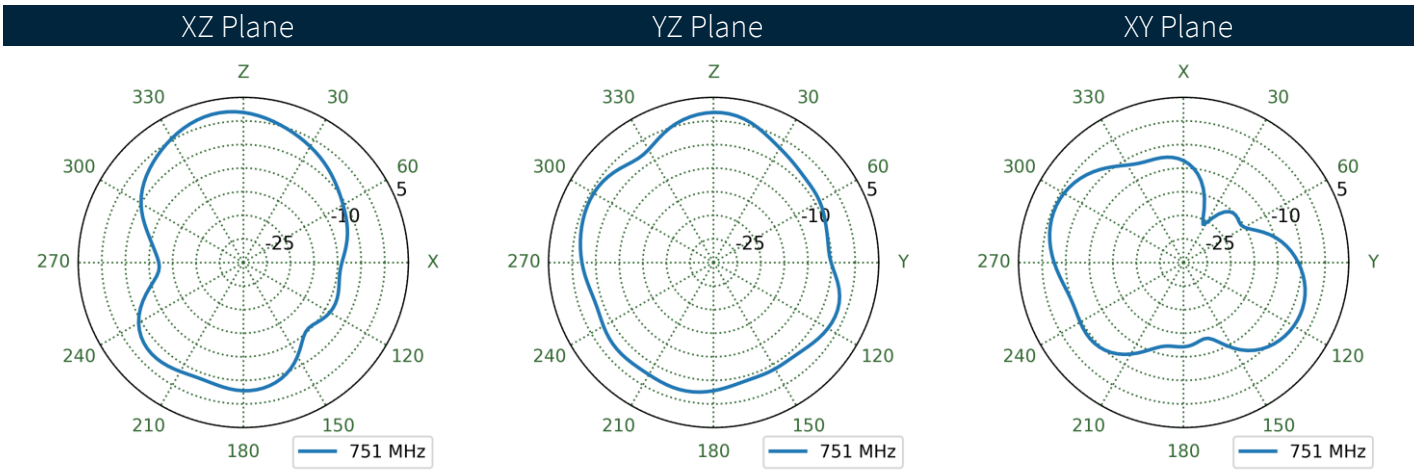
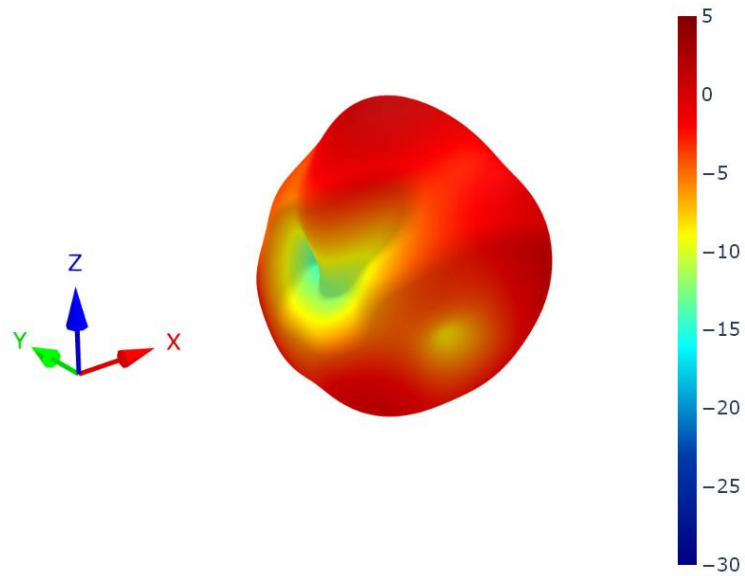

5.9 LTE4 Patterns at 750 MHz

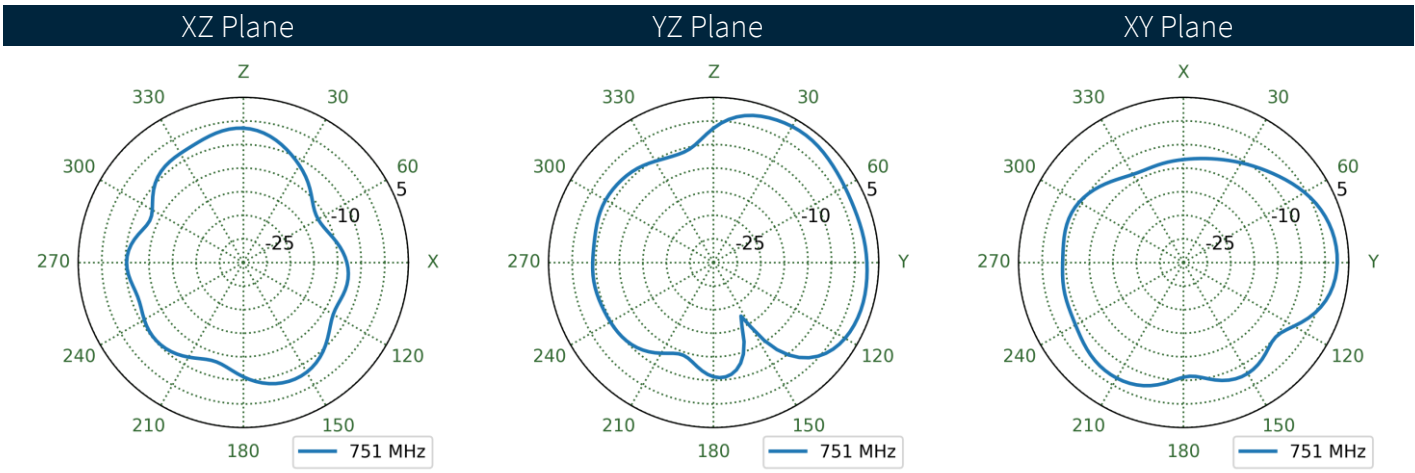
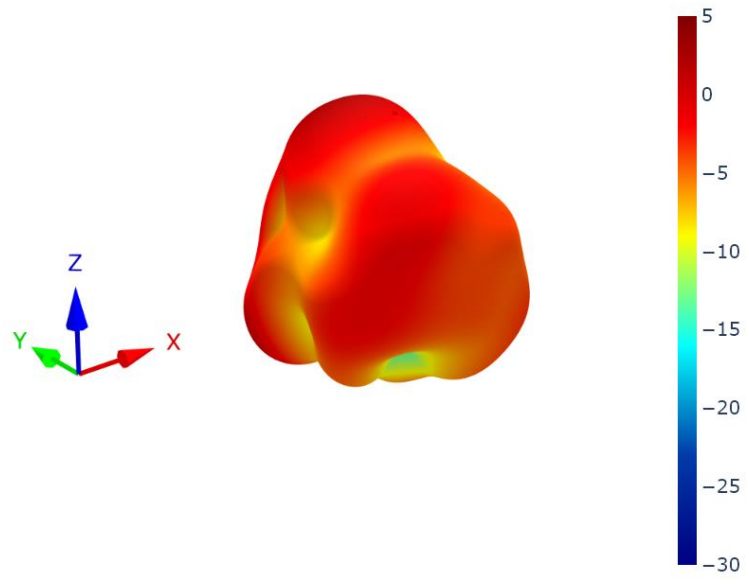

5.10 LTE1 Patterns at 890 MHz

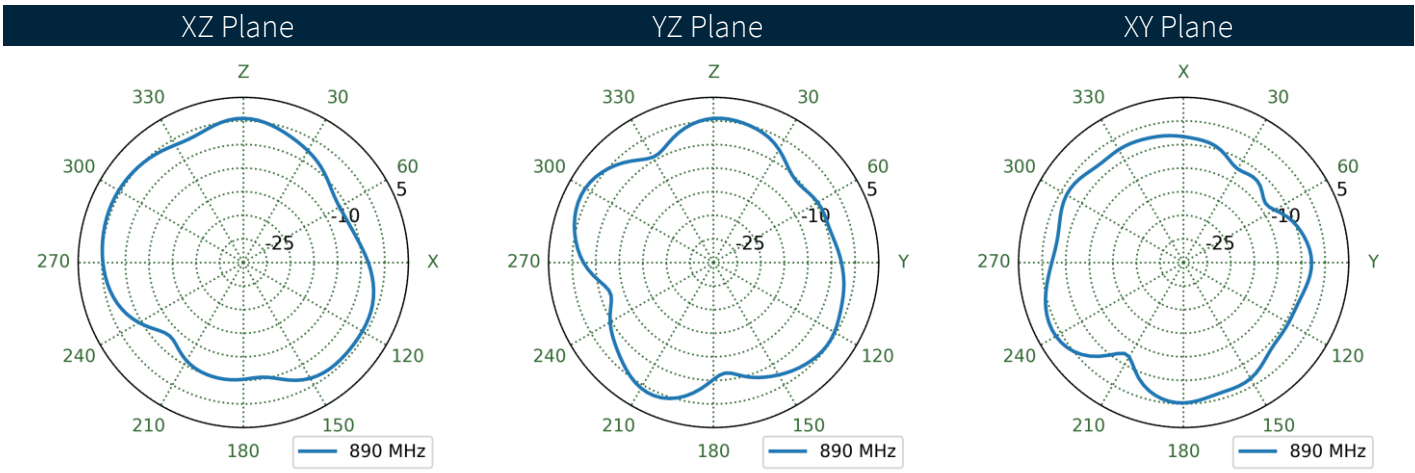
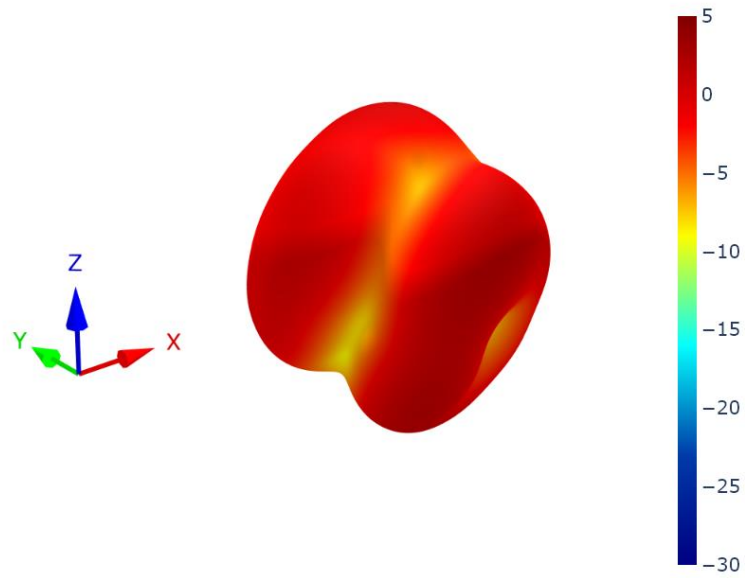

5.11 LTE2 Patterns at 890 MHz

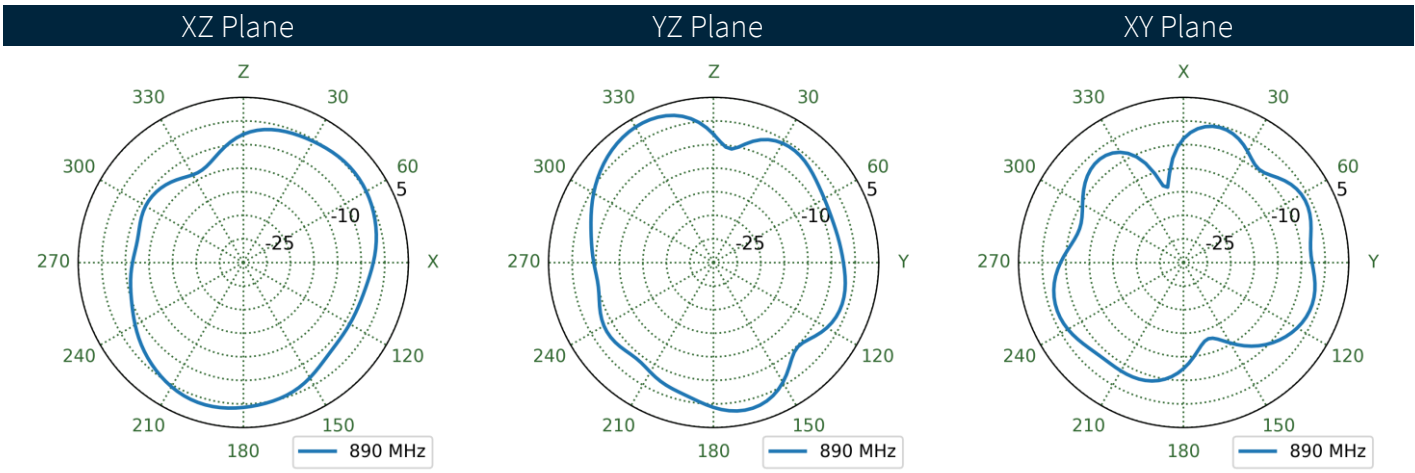
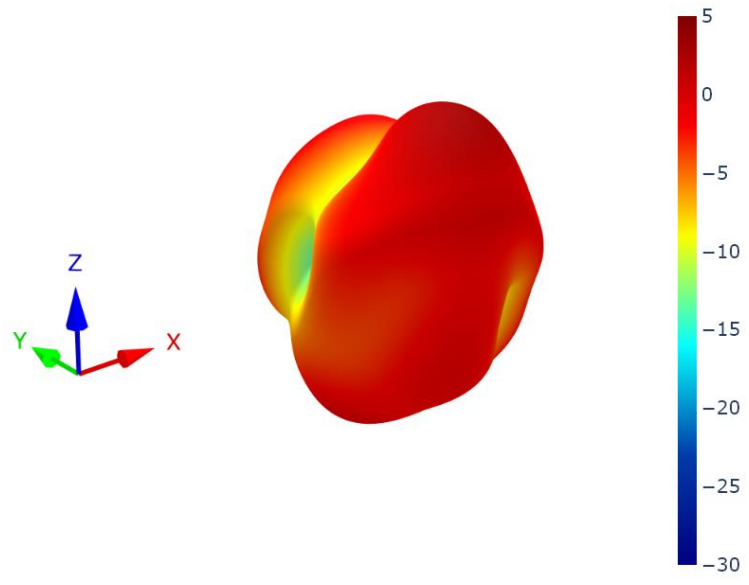

5.12 LTE3 Patterns at 890 MHz

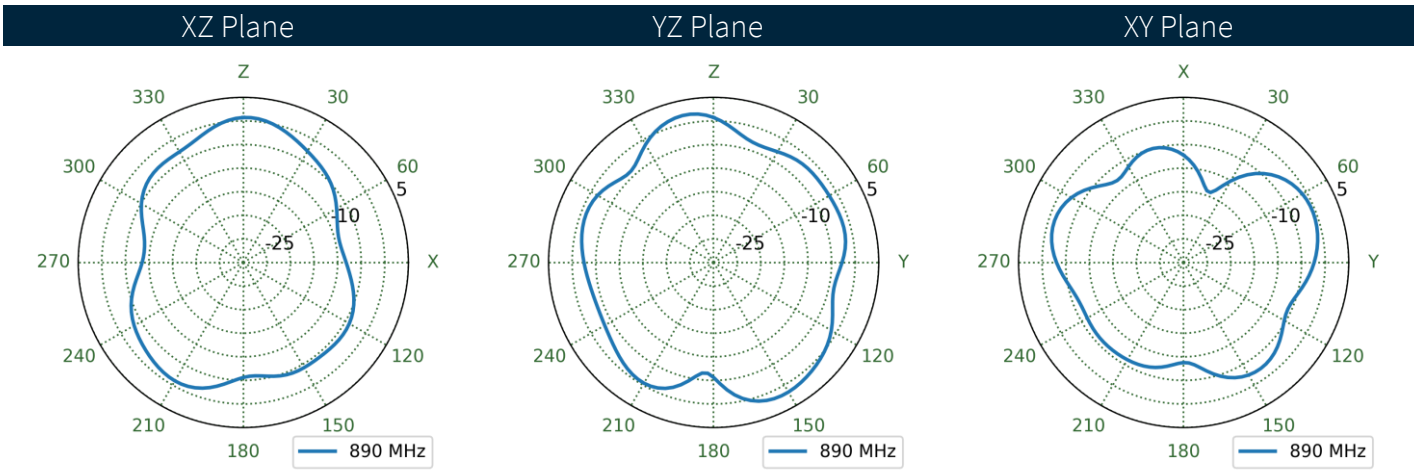
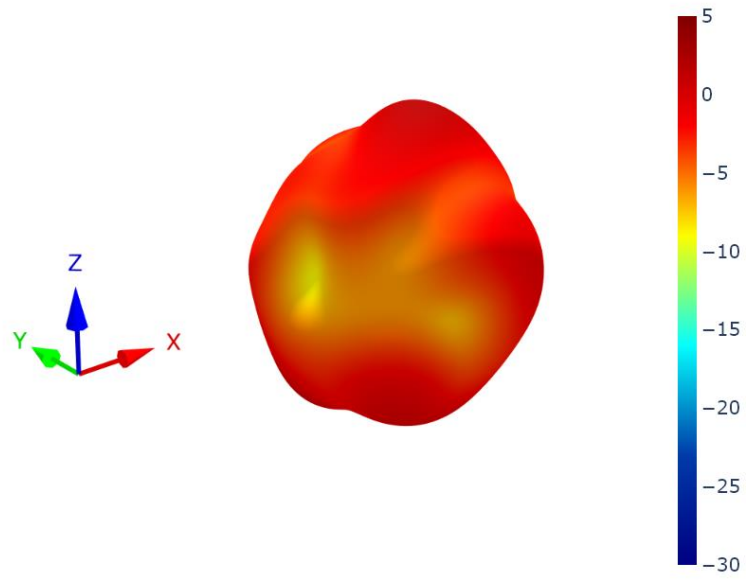

5.13 LTE4 Patterns at 890 MHz

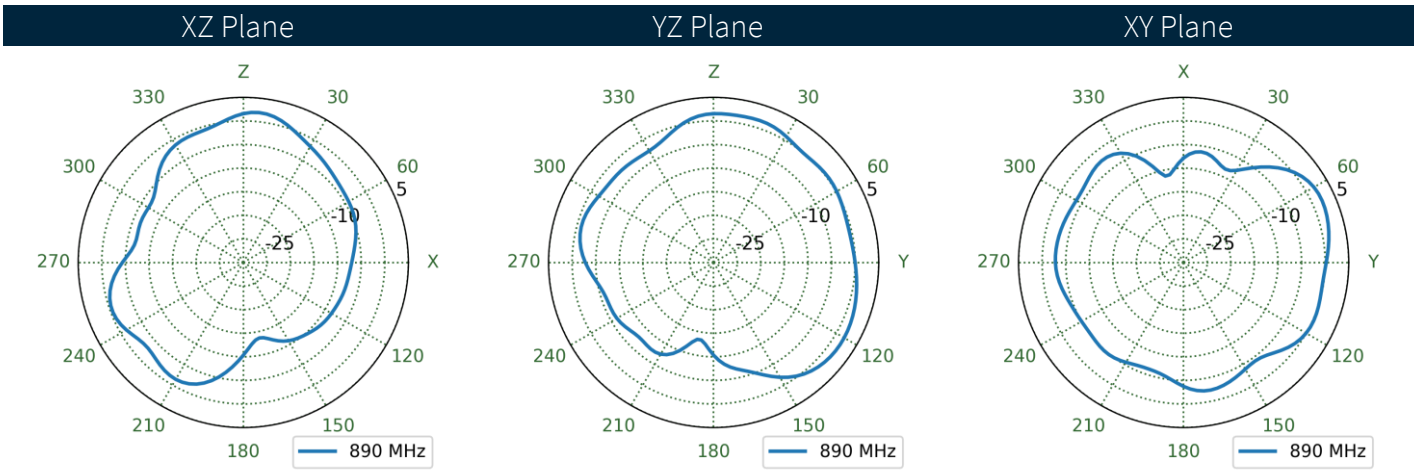
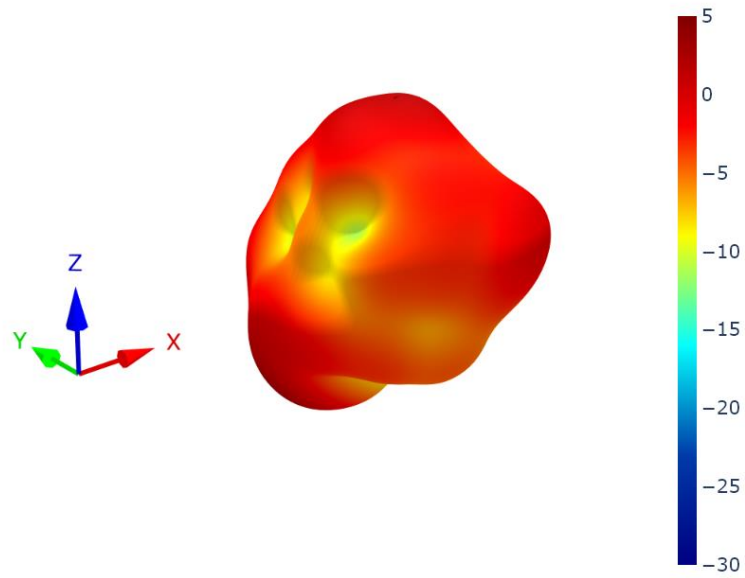

5.14 LTE1 Patterns at 1470 MHz

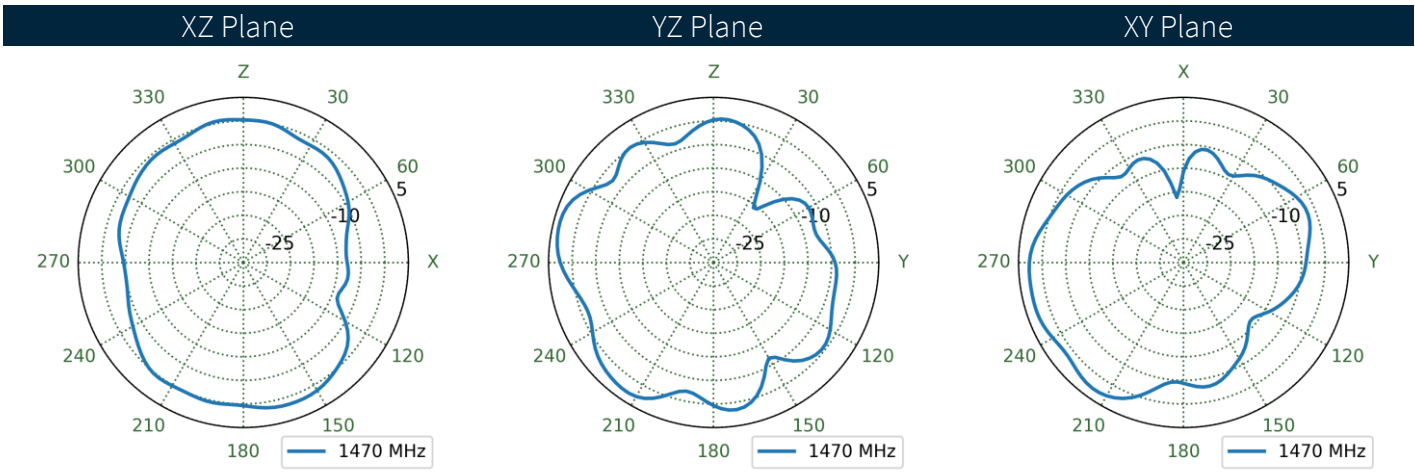
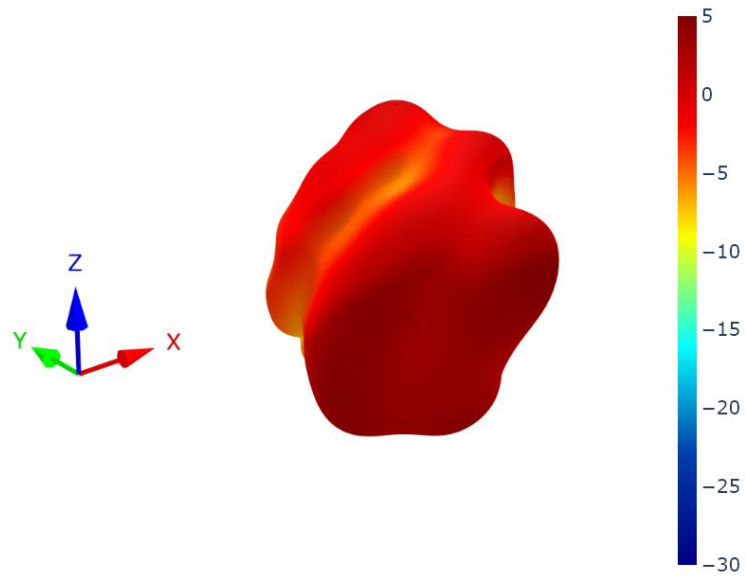

5.15 LTE2 Patterns at 1470 MHz

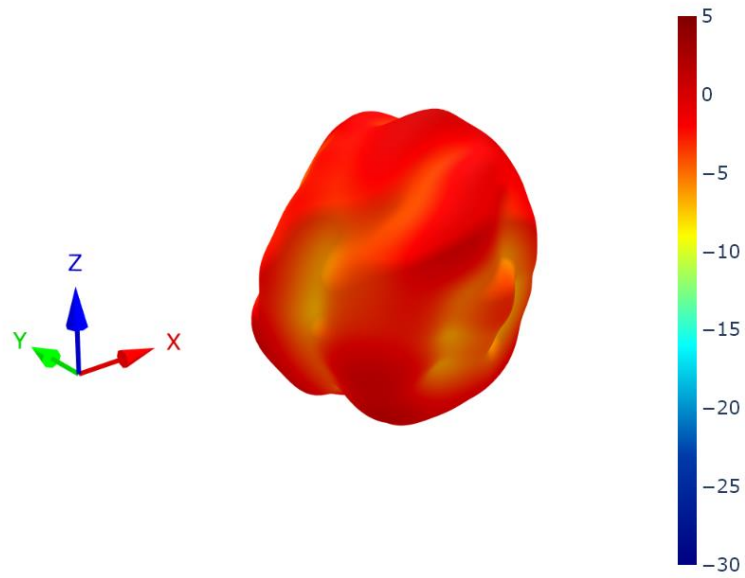

XZ Plane YZ Plane XY Plane

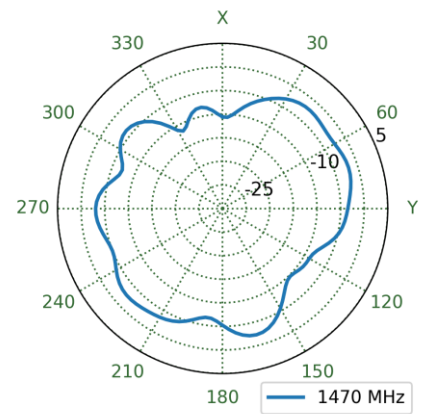
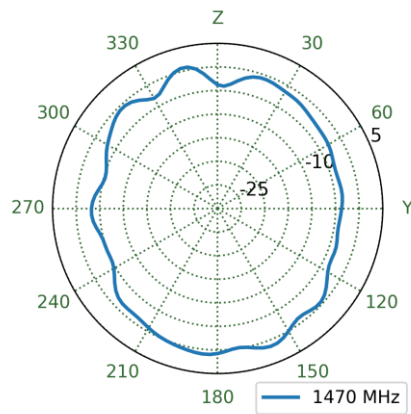
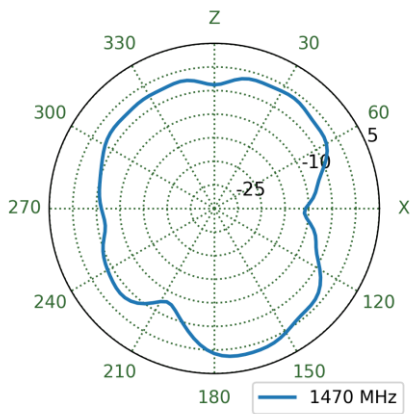

5.16 LTE3 Patterns at 1470 MHz

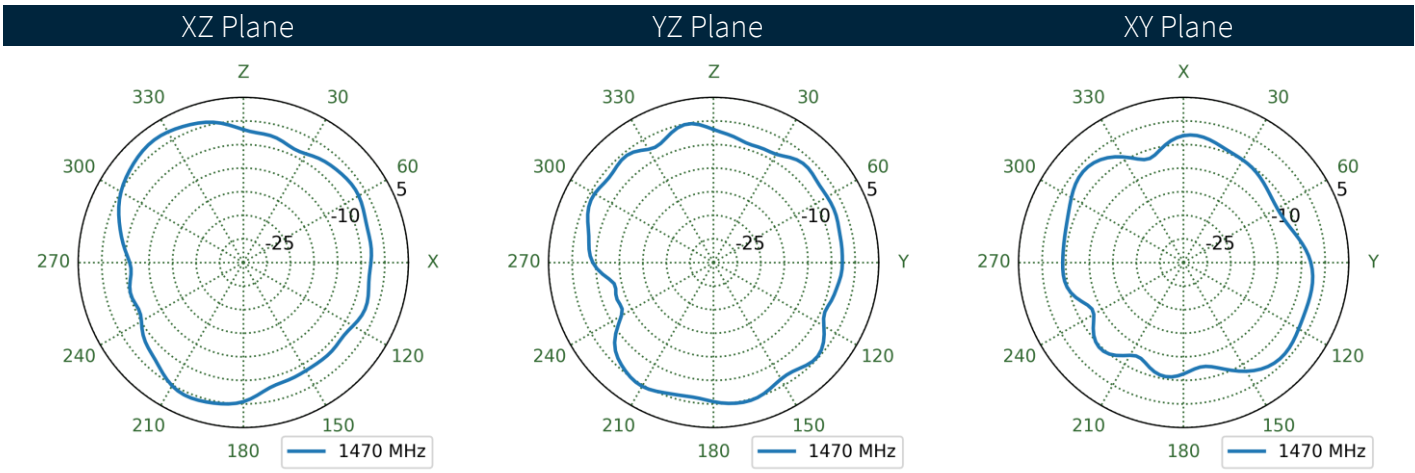
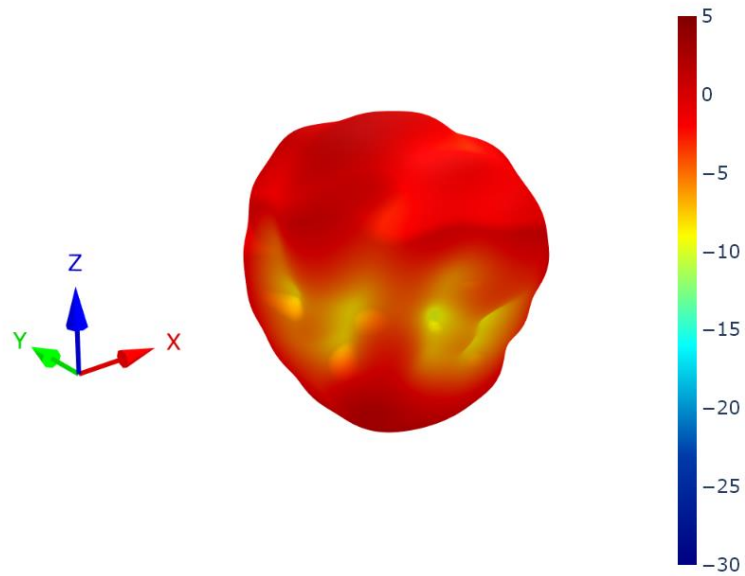

5.17 LTE4 Patterns at 1470 MHz

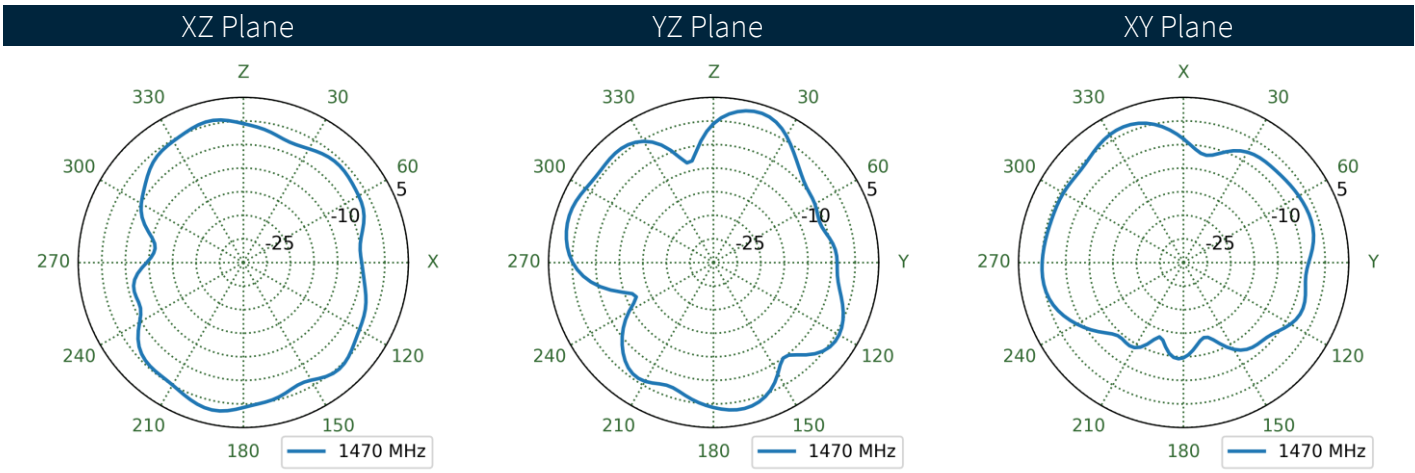
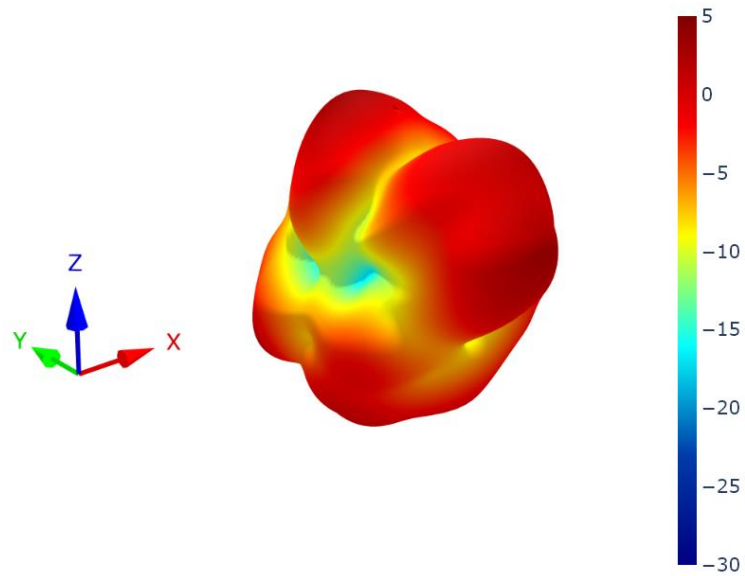

5.18 LTE1 Patterns at 1805 MHz

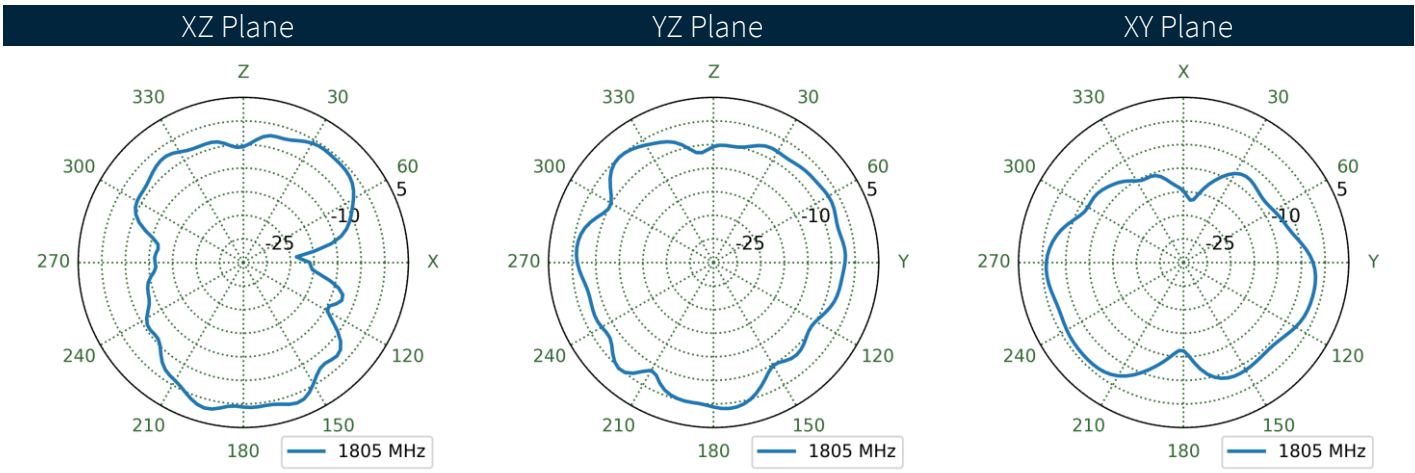
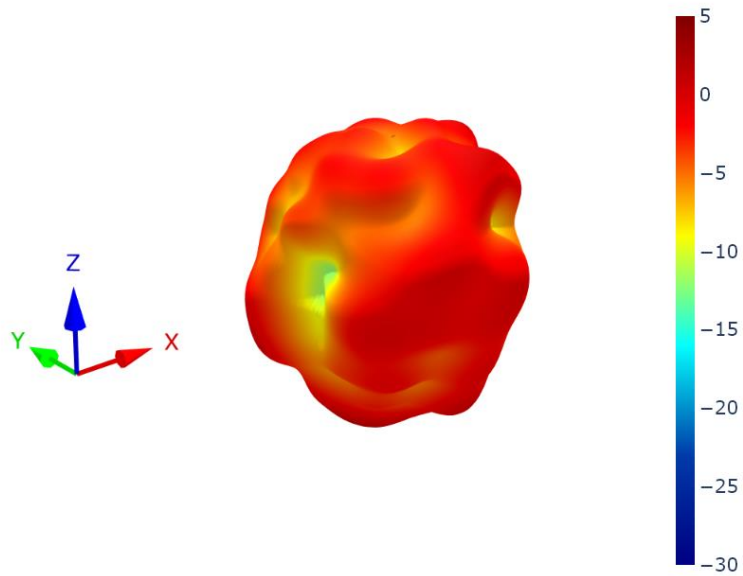

5.19 LTE2 Patterns at 1805 MHz

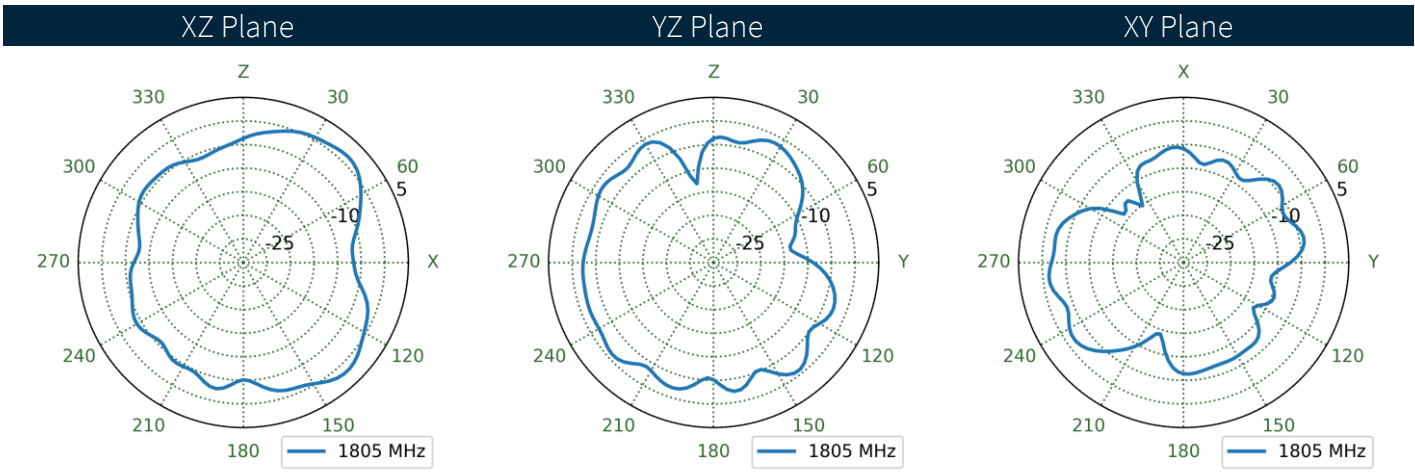
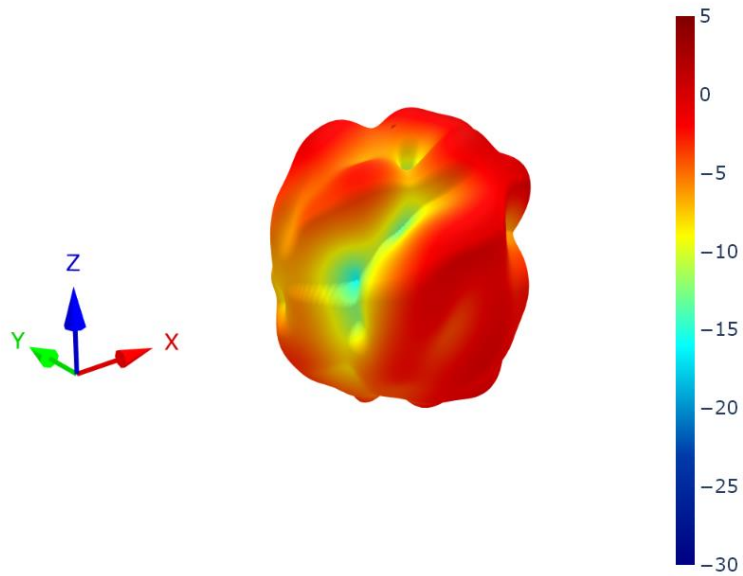

5.20 LTE3 Patterns at 1805 MHz

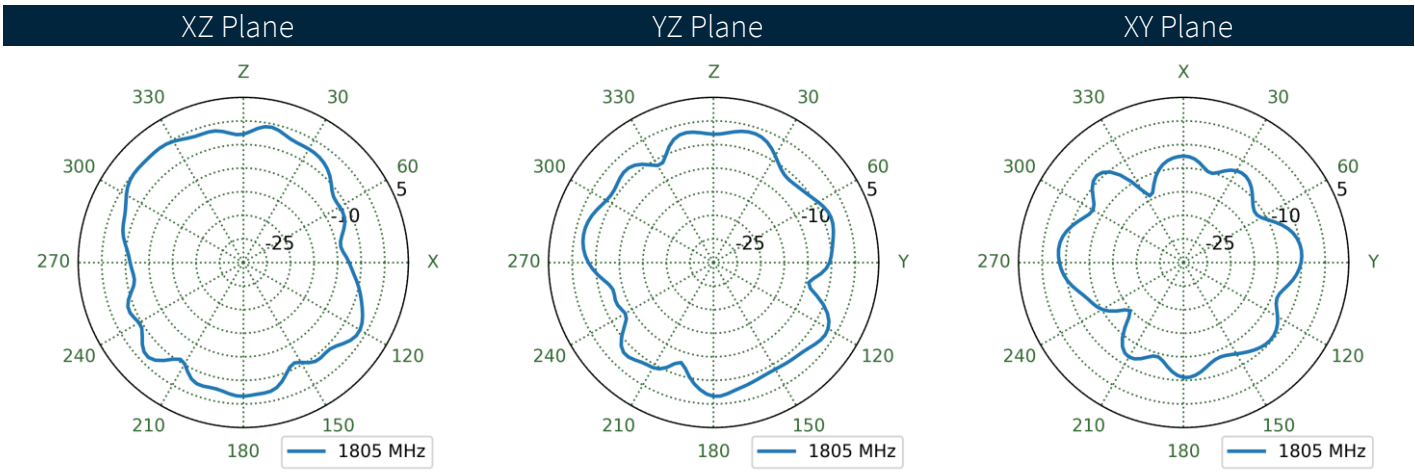
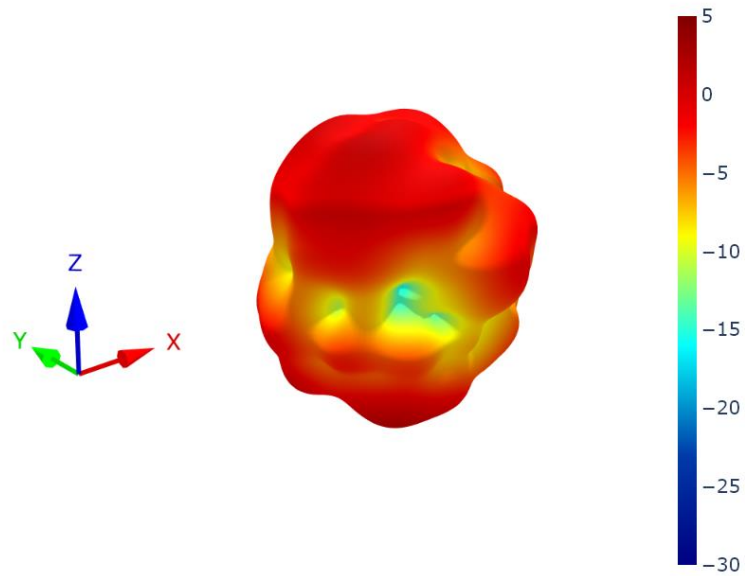

5.21 LTE4 Patterns at 1805 MHz

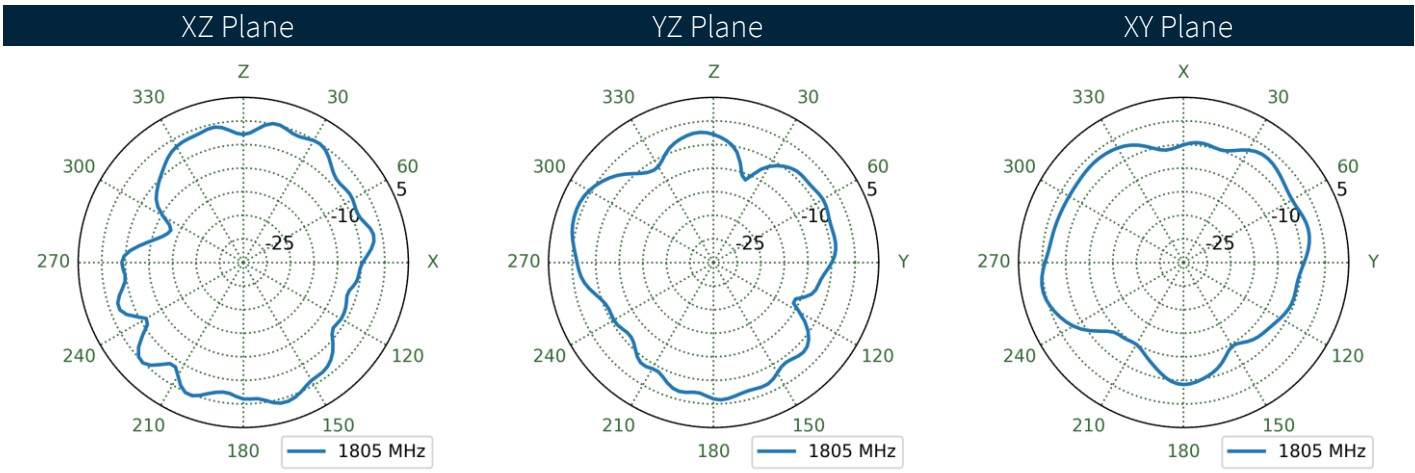
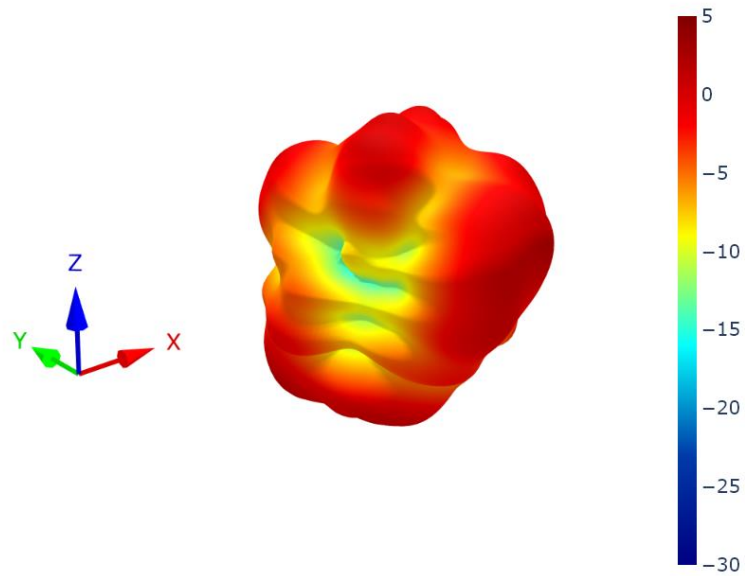

5.22 LTE1 Patterns at 1920 MHz

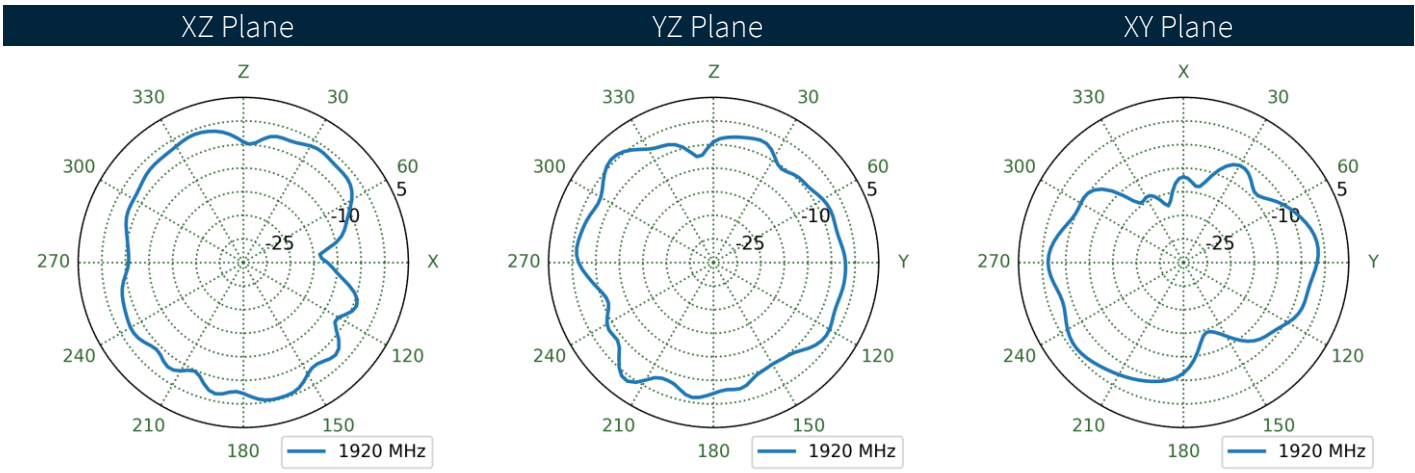
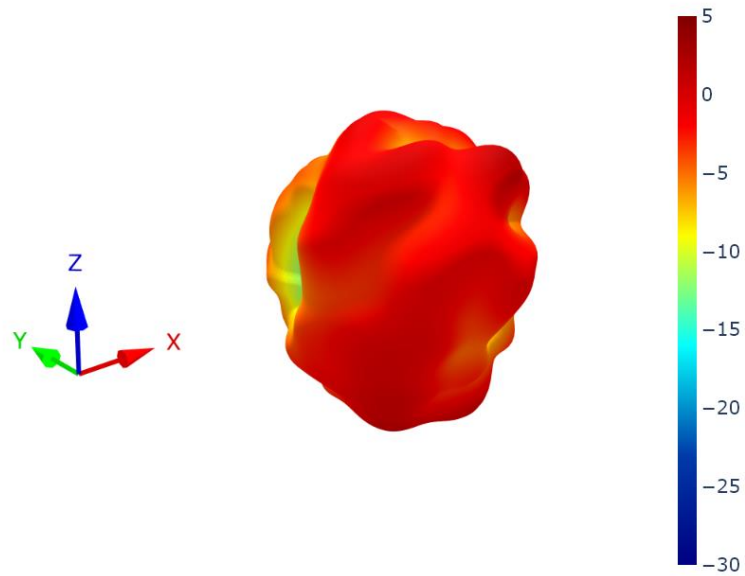

5.23 LTE2 Patterns at 1920 MHz

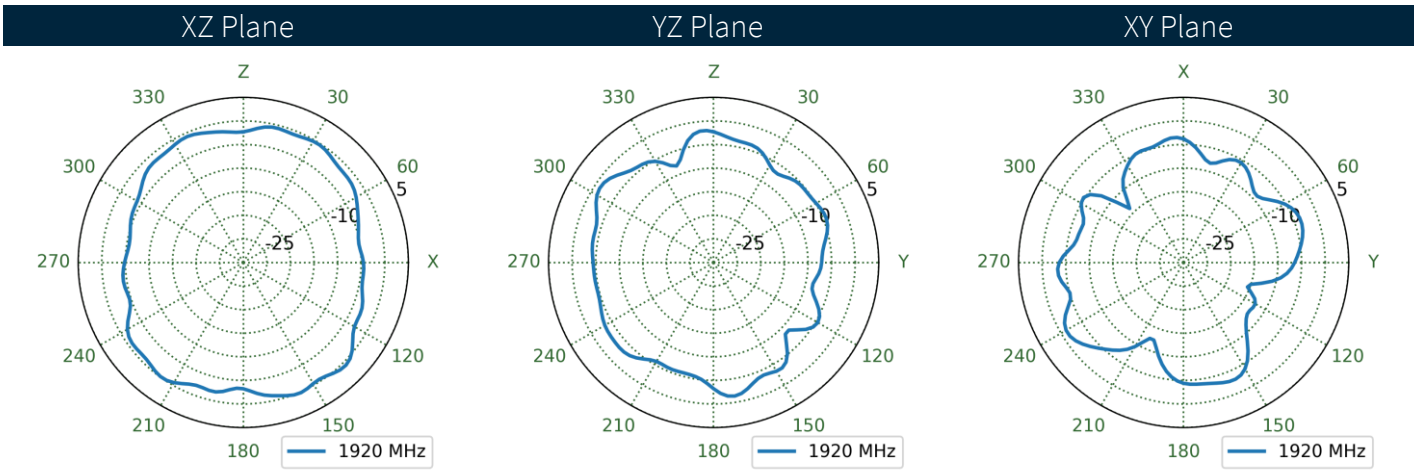
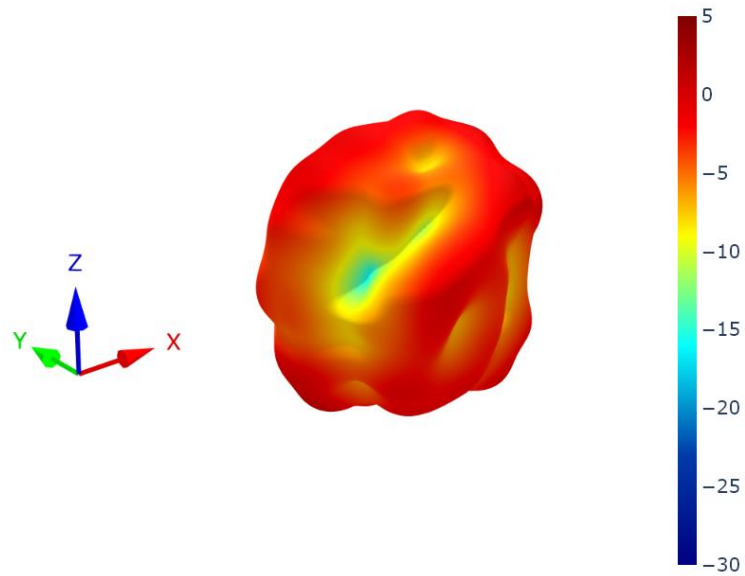

5.24 LTE3 Patterns at 1920 MHz

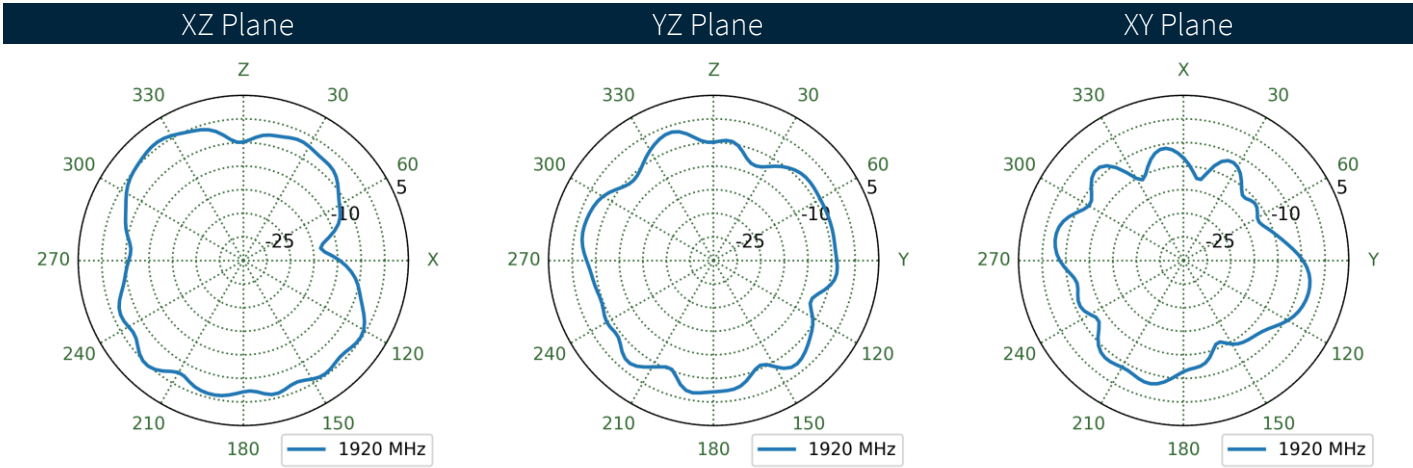
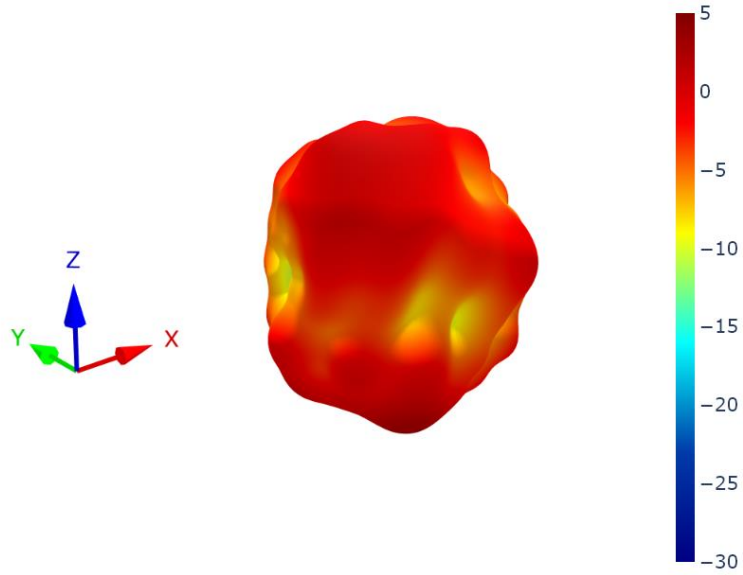

5.25 LTE4 Patterns at 1920 MHz

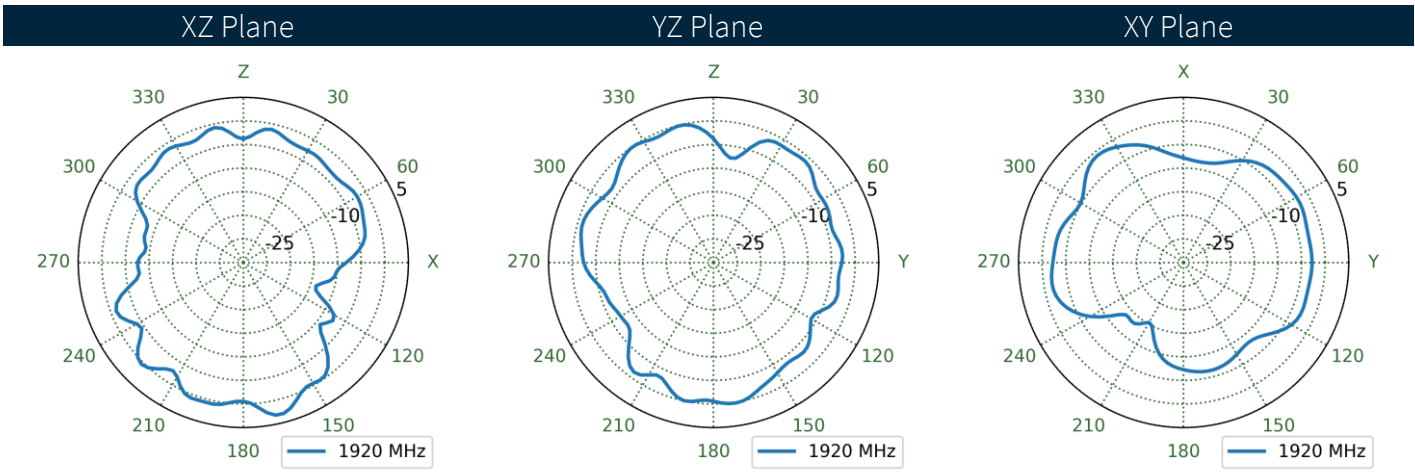
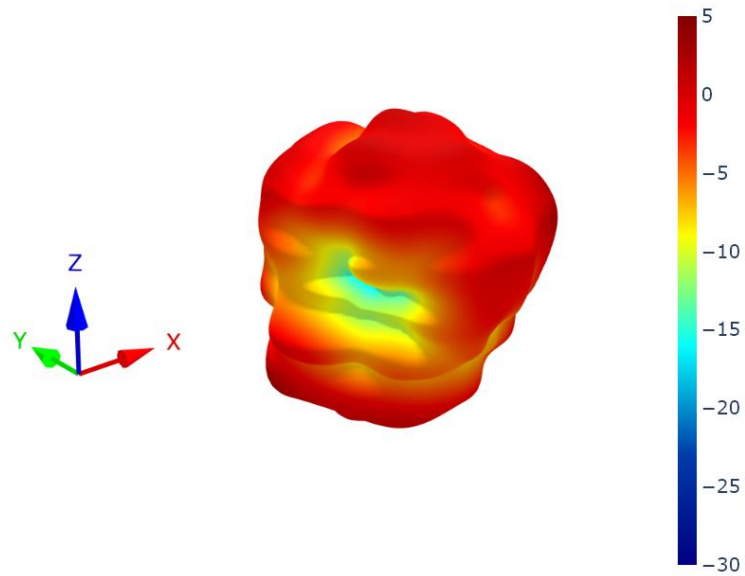

5.26 LTE1 Patterns at 1990 MHz

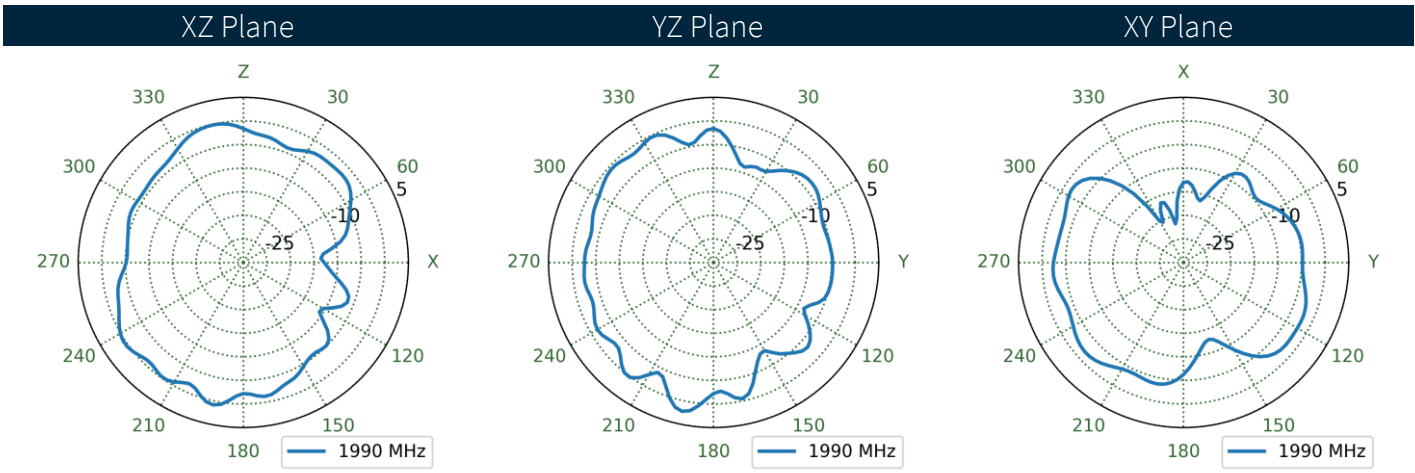
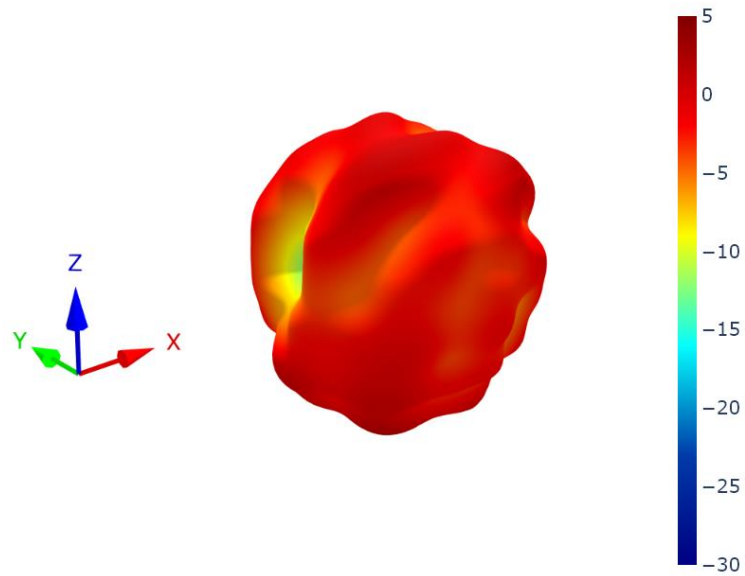

5.27 LTE2 Patterns at 1990 MHz

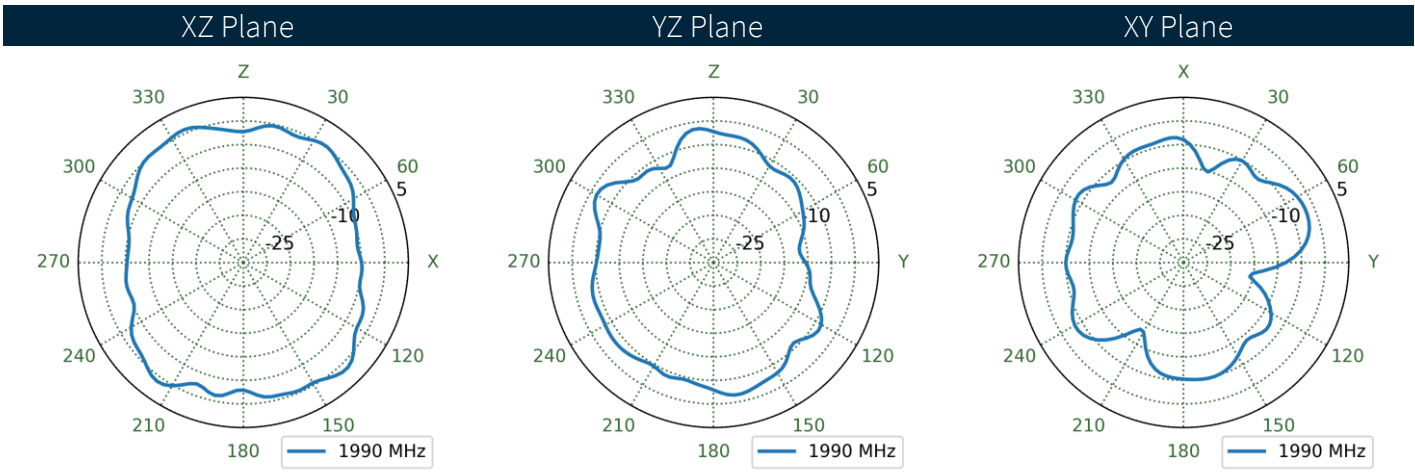
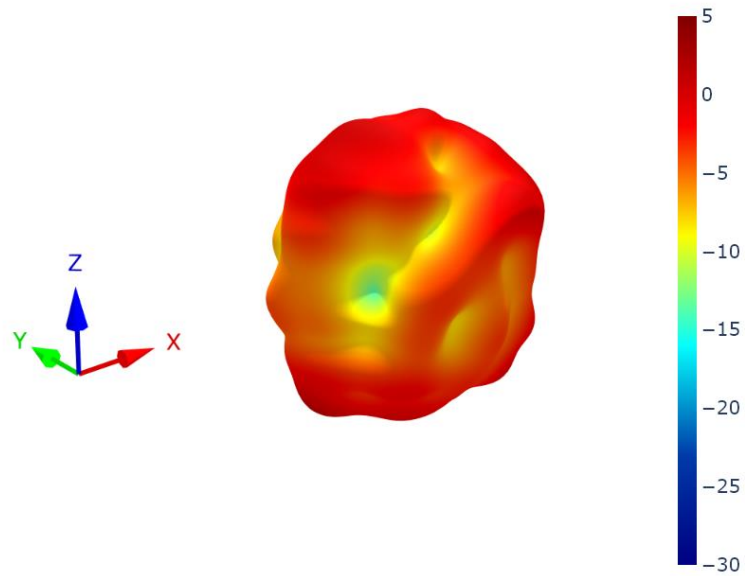

5.28 LTE3 Patterns at 1990 MHz

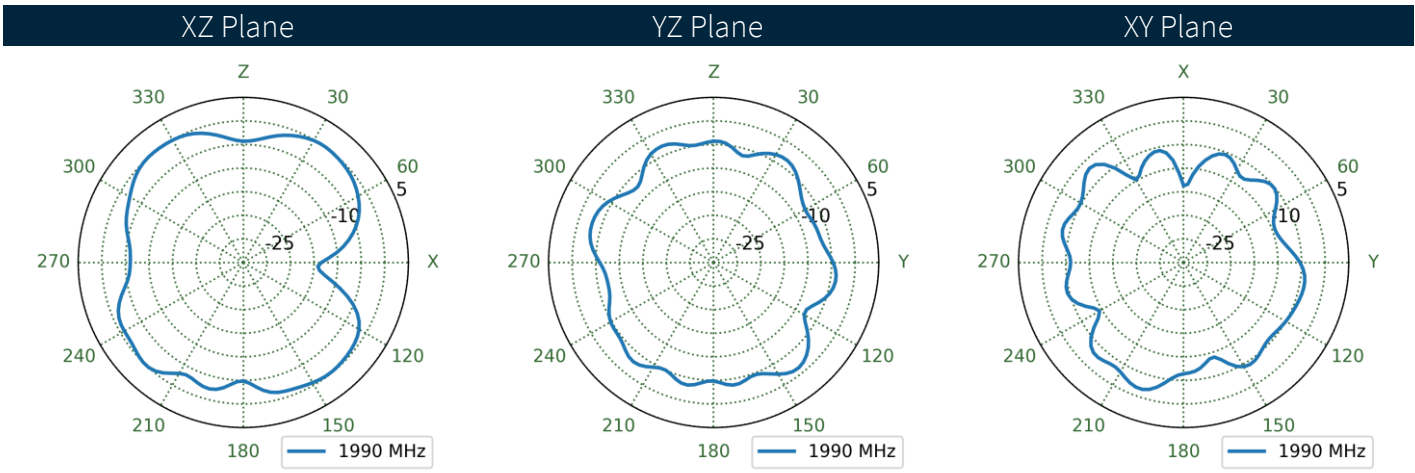
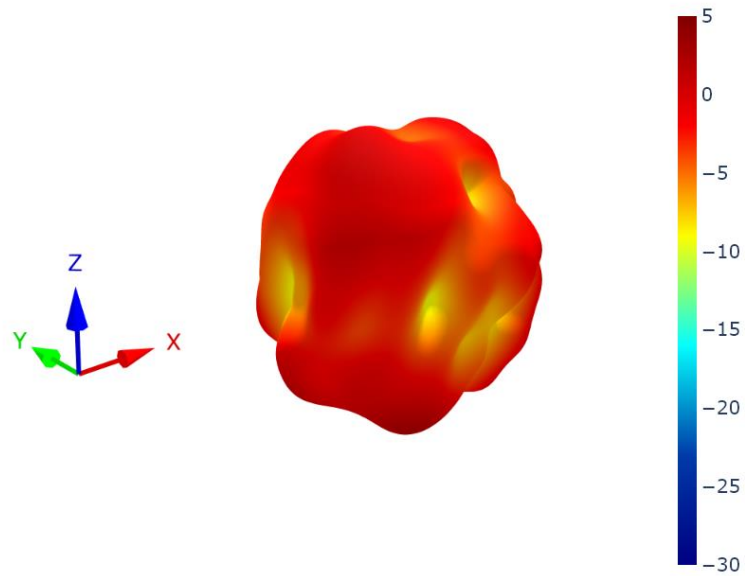

5.29 LTE4 Patterns at 1990 MHz

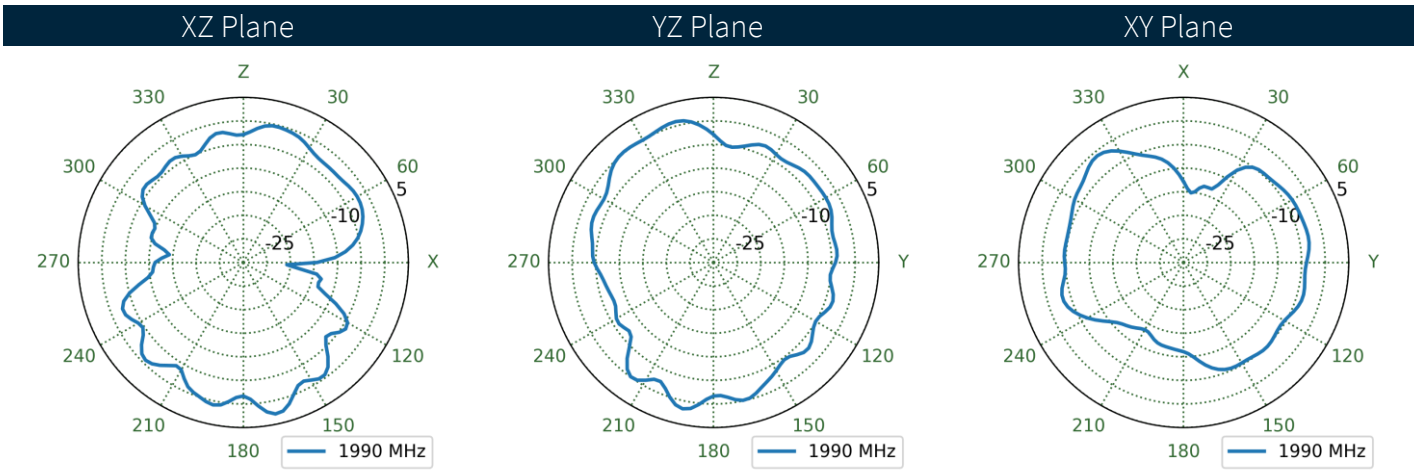
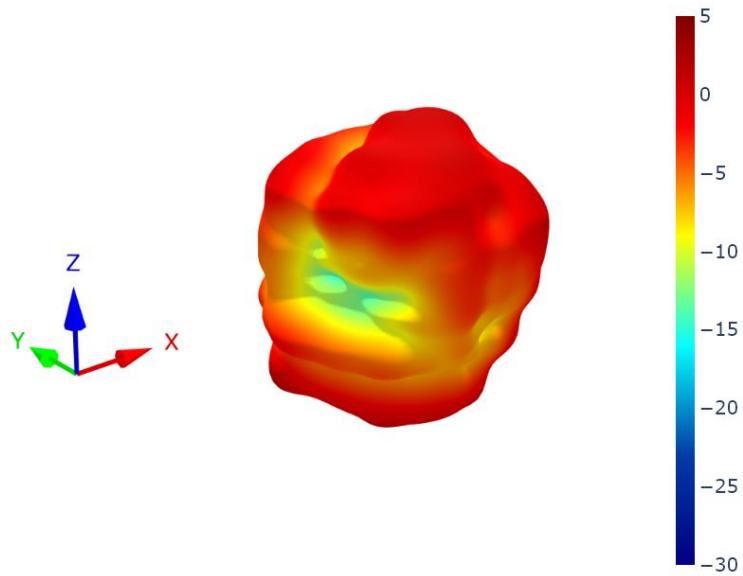

5.30 LTE1 Patterns at 2360 MHz

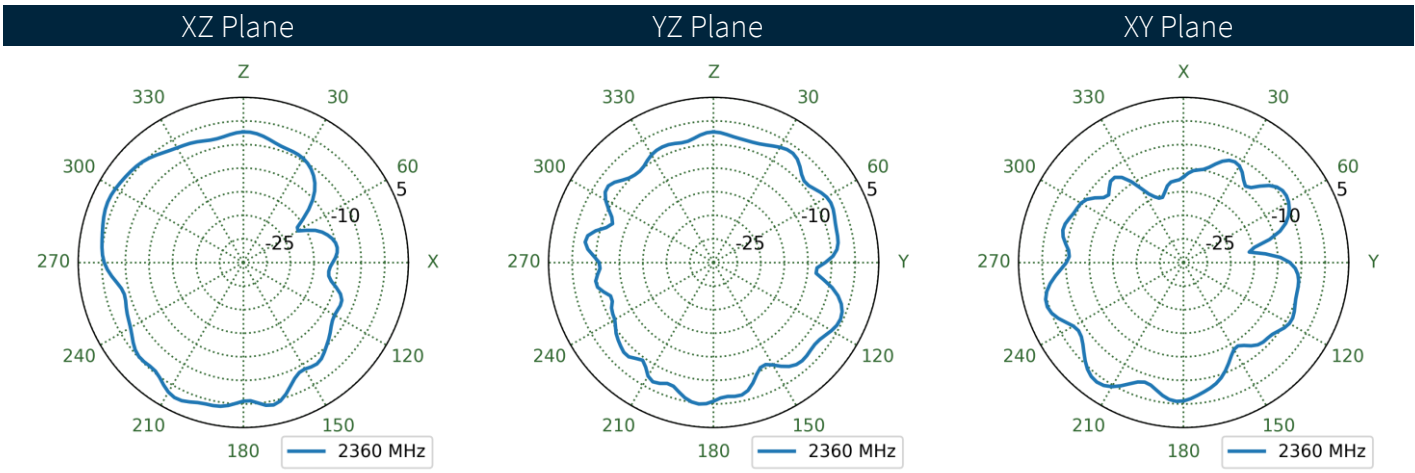
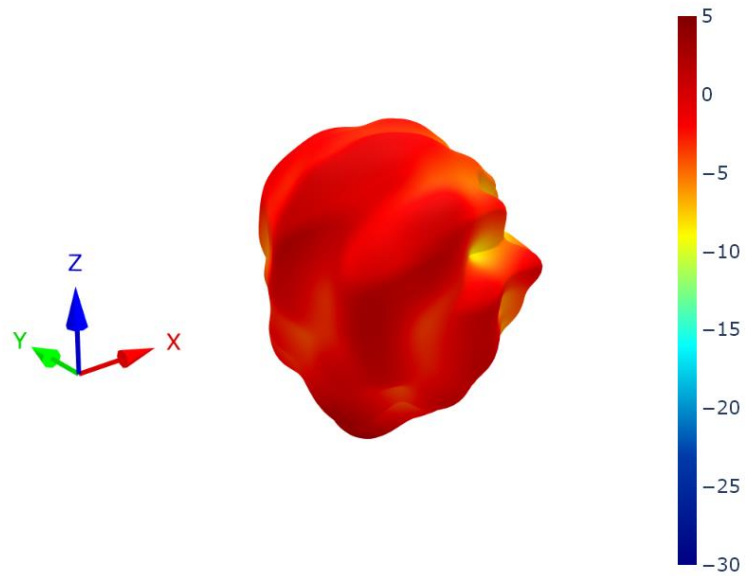

5.31 LTE2 Patterns at 2360 MHz

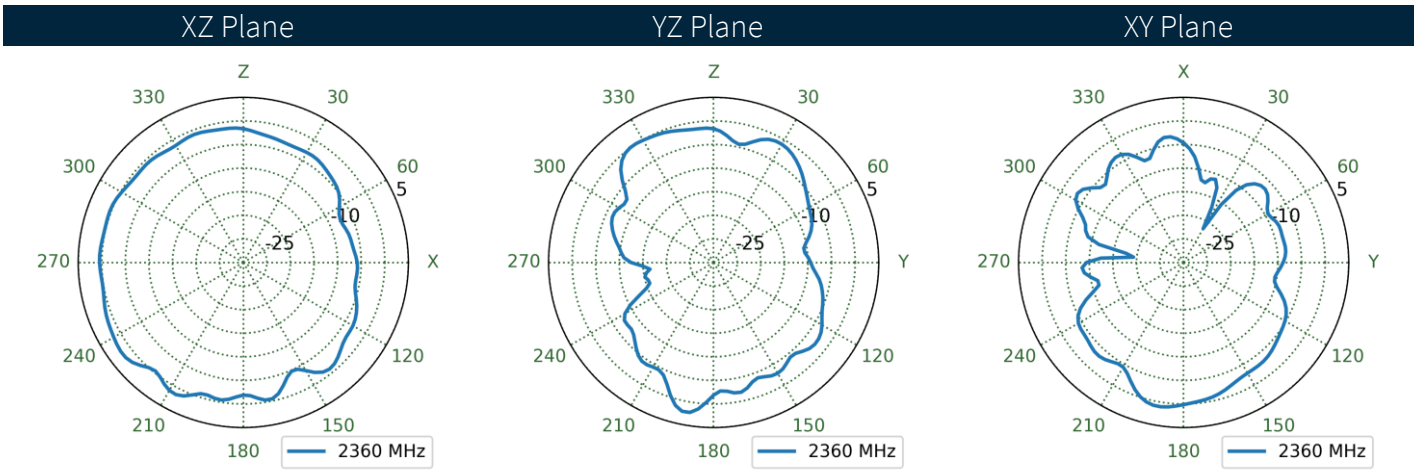
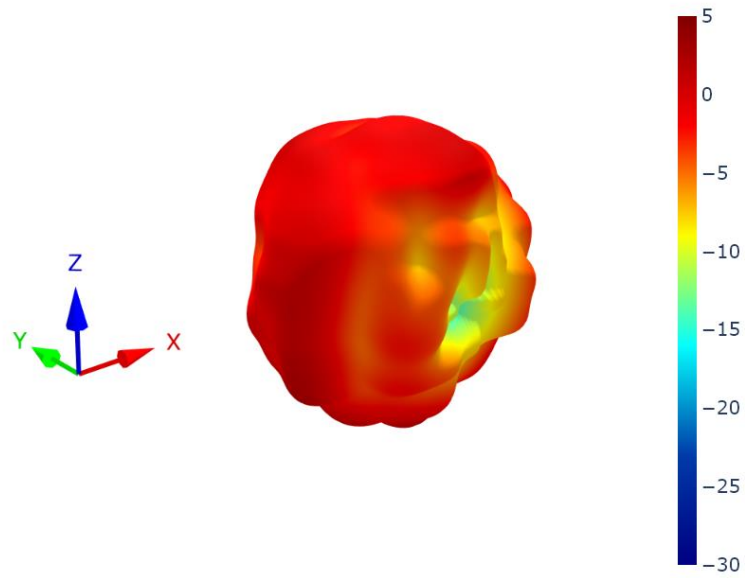

5.32 LTE3 Patterns at 2360 MHz

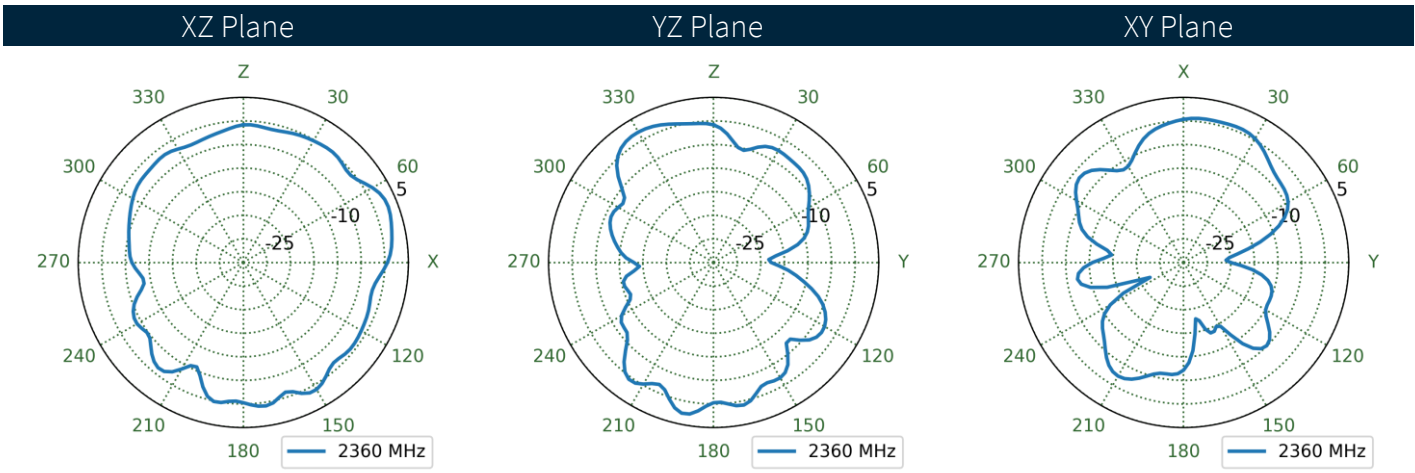
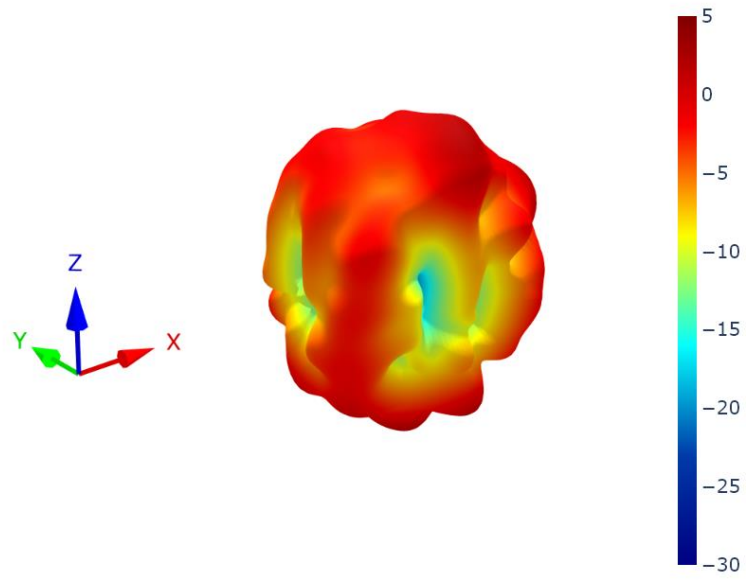

5.33 LTE4 Patterns at 2360 MHz

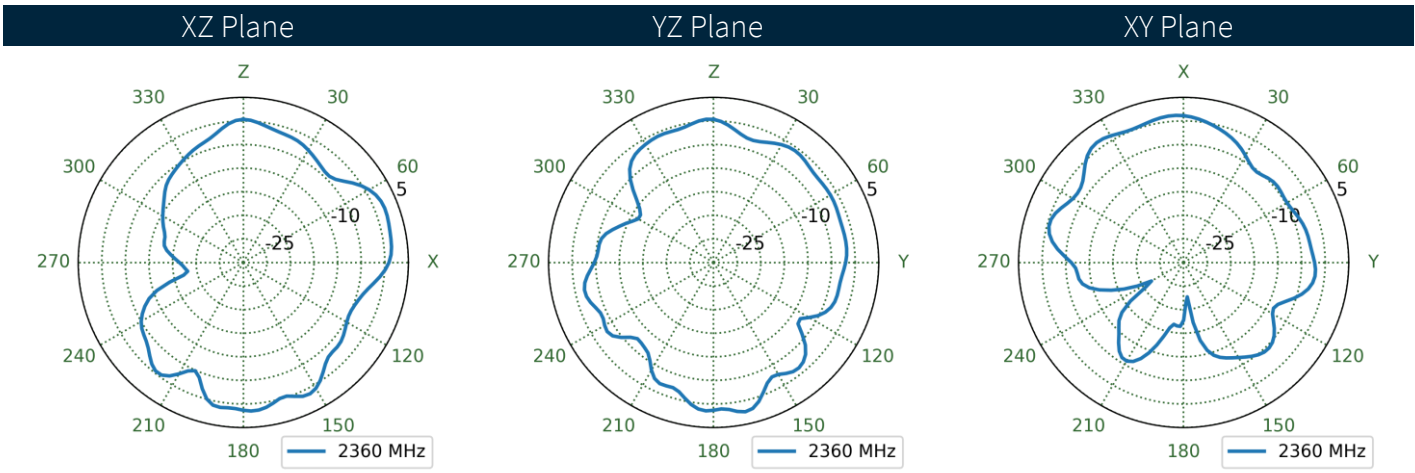
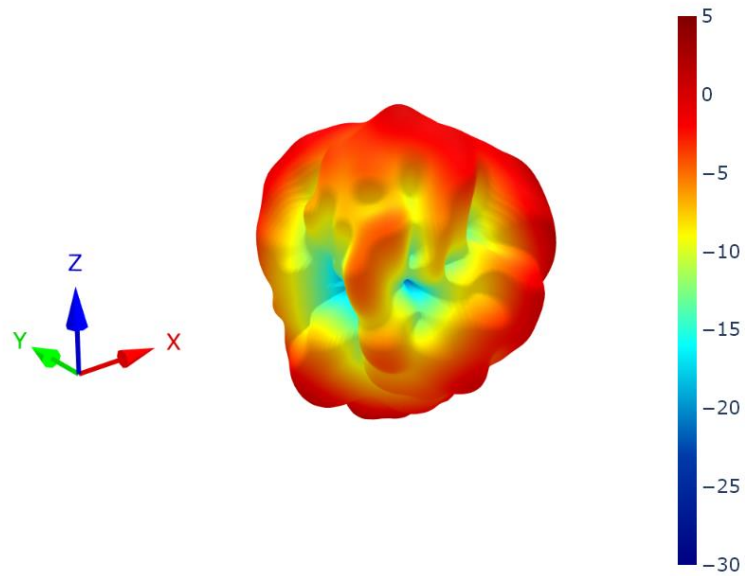

5.34 LTE1 Patterns at 2595 MHz

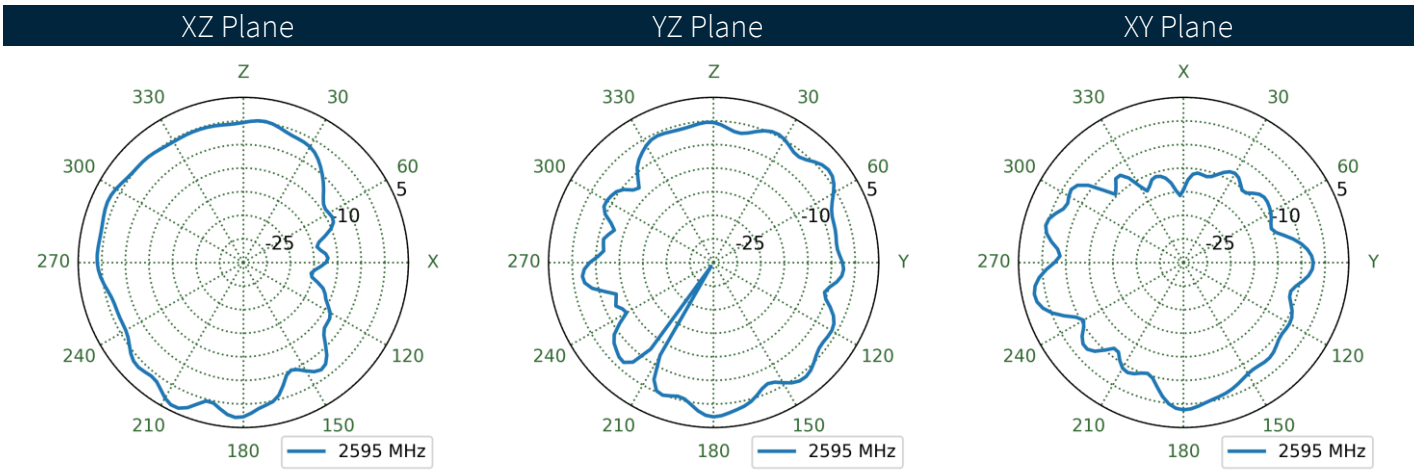
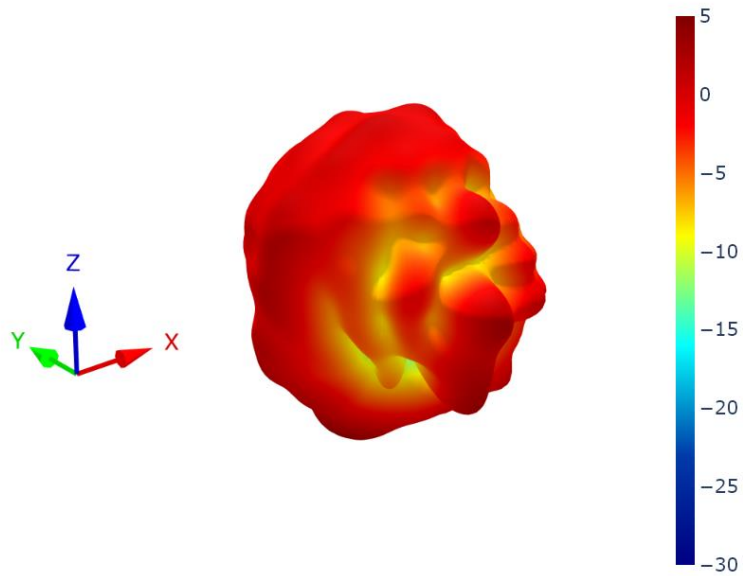

5.35 LTE2 Patterns at 2595 MHz

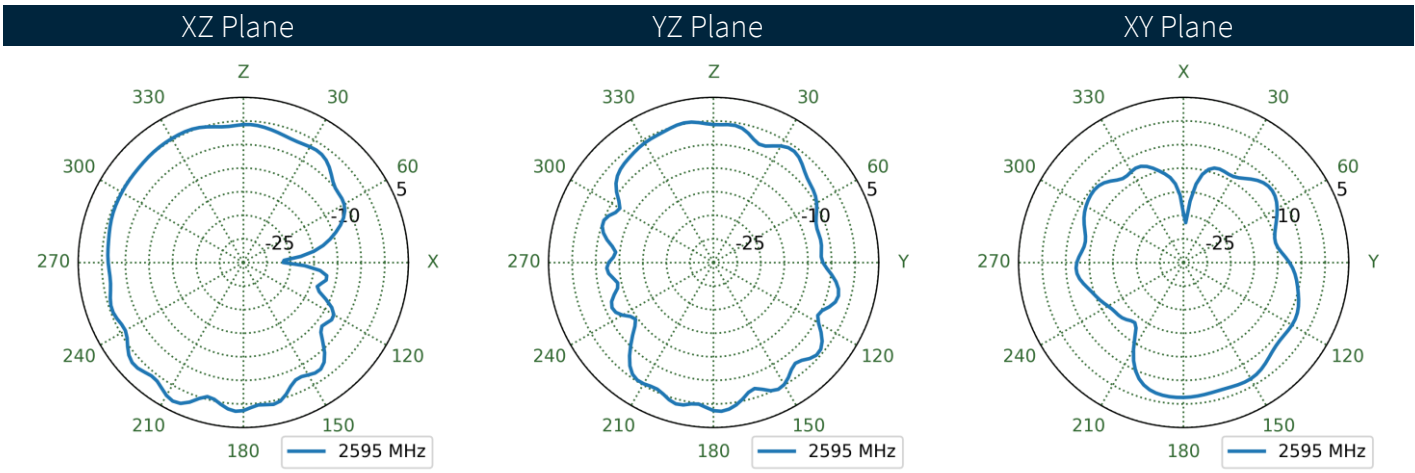
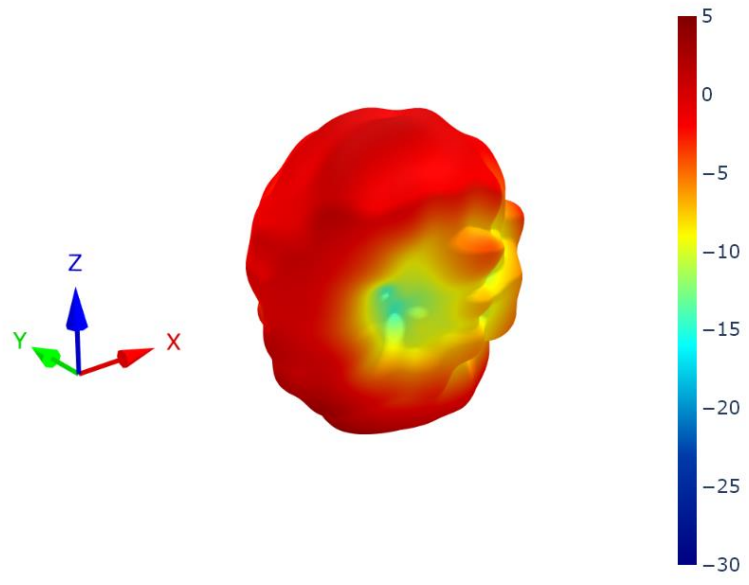

5.36 LTE3 Patterns at 2595 MHz

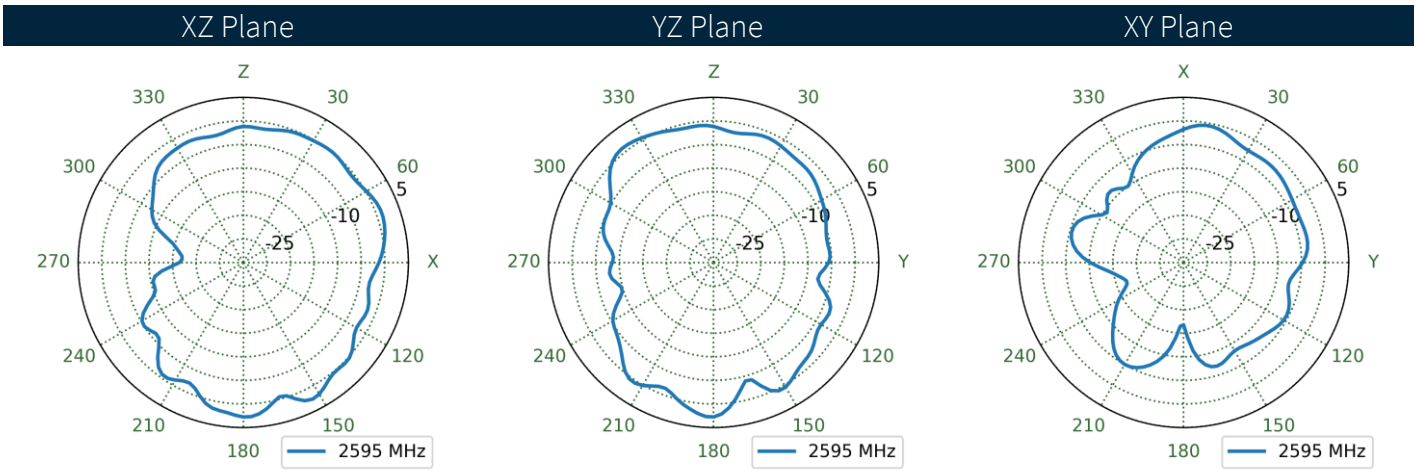
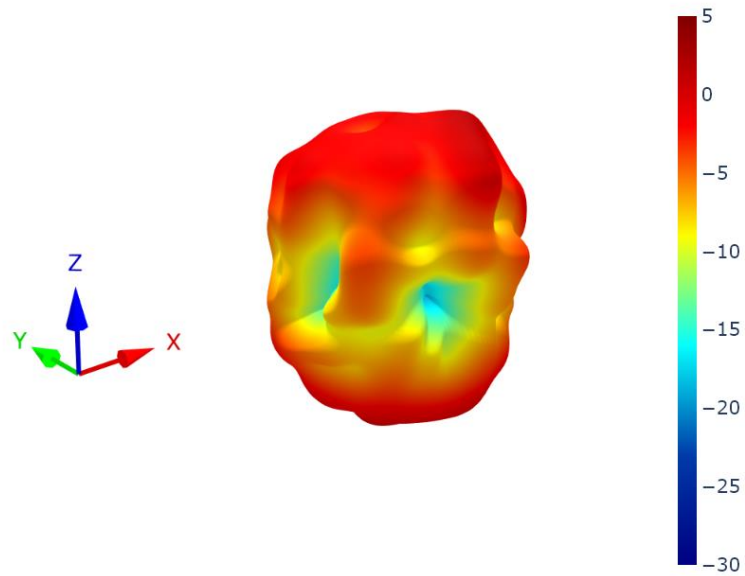

5.37 LTE4 Patterns at 2595 MHz

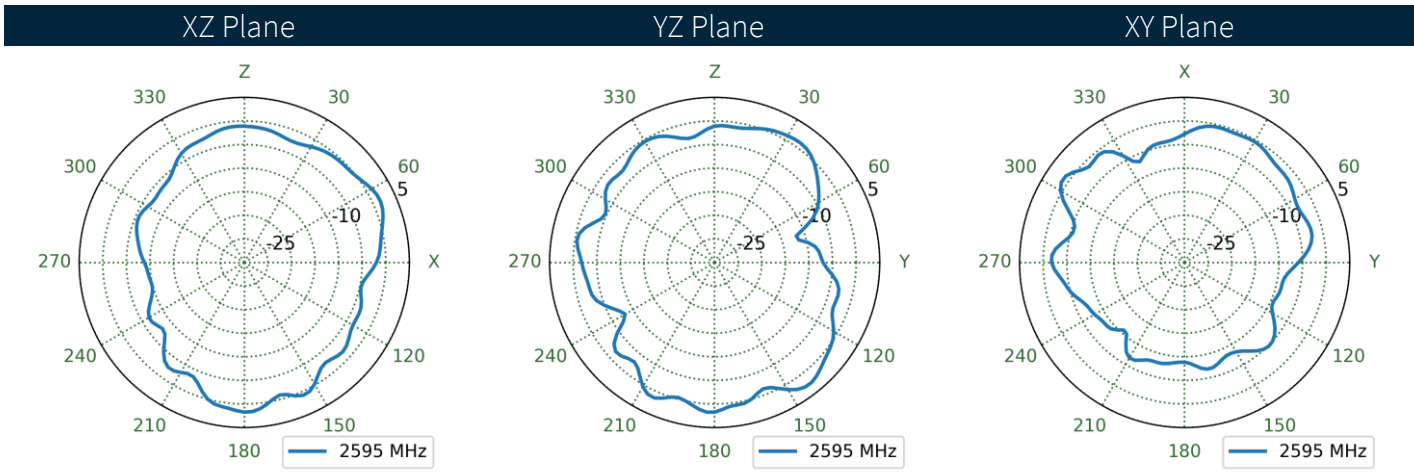
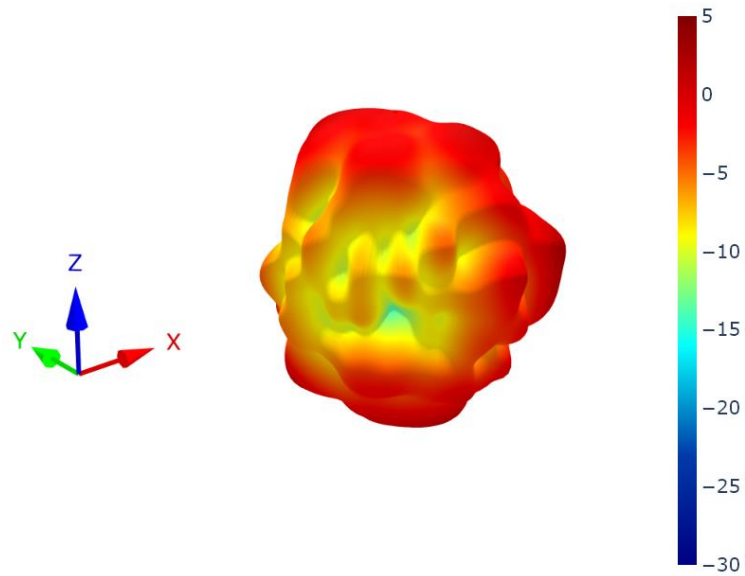

5.38 LTE1 Patterns at 3550 MHz

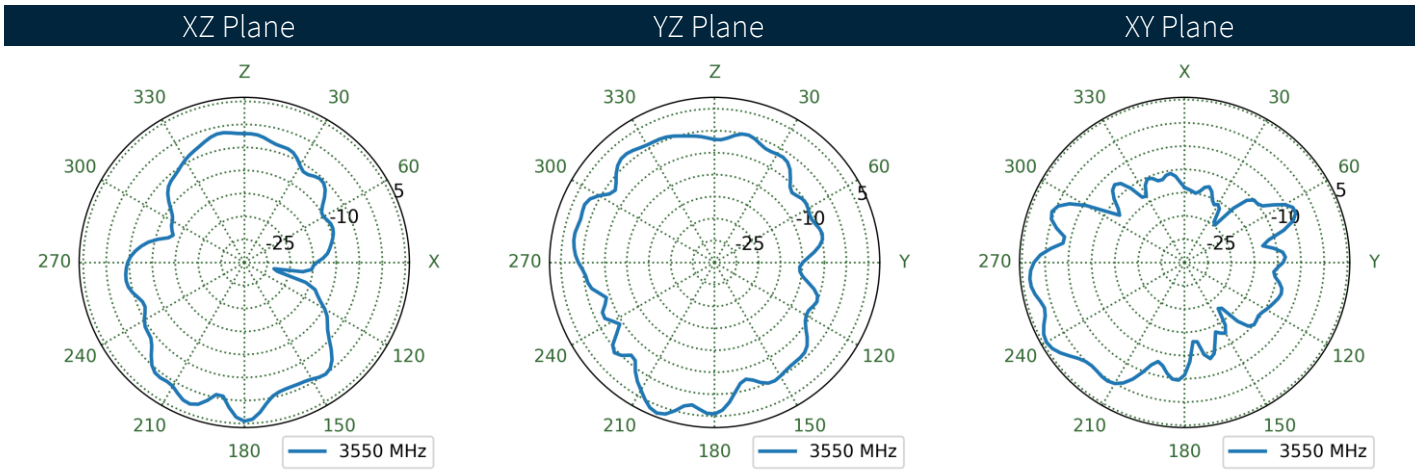
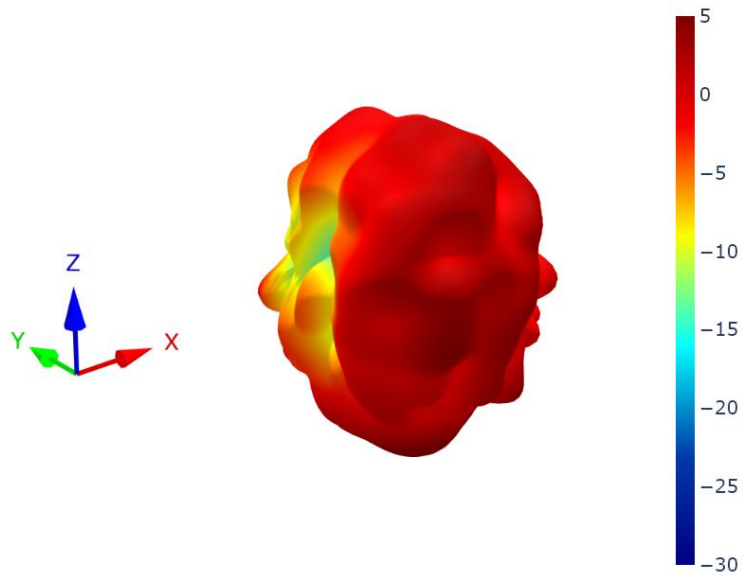

5.39 LTE2 Patterns at 3550 MHz

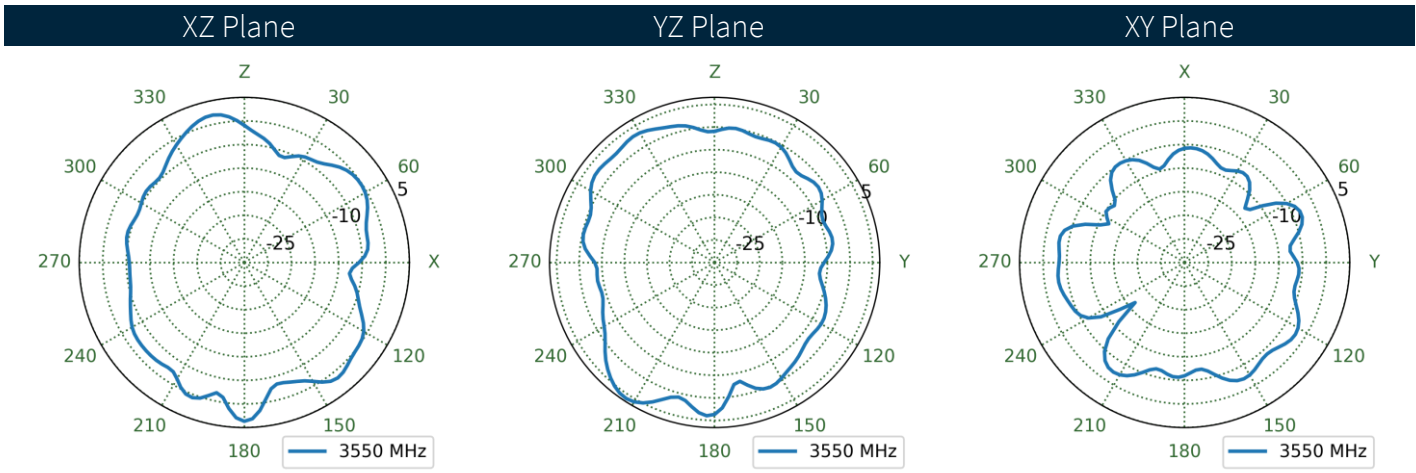
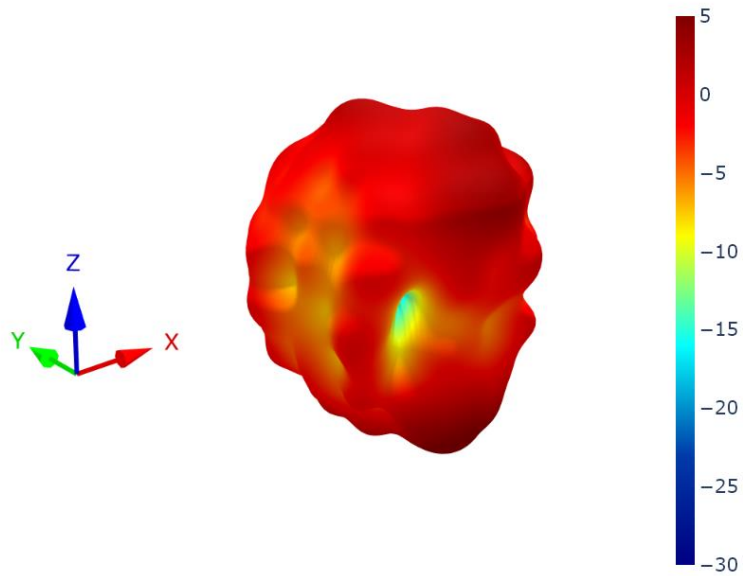

5.40 LTE3 Patterns at 3550 MHz

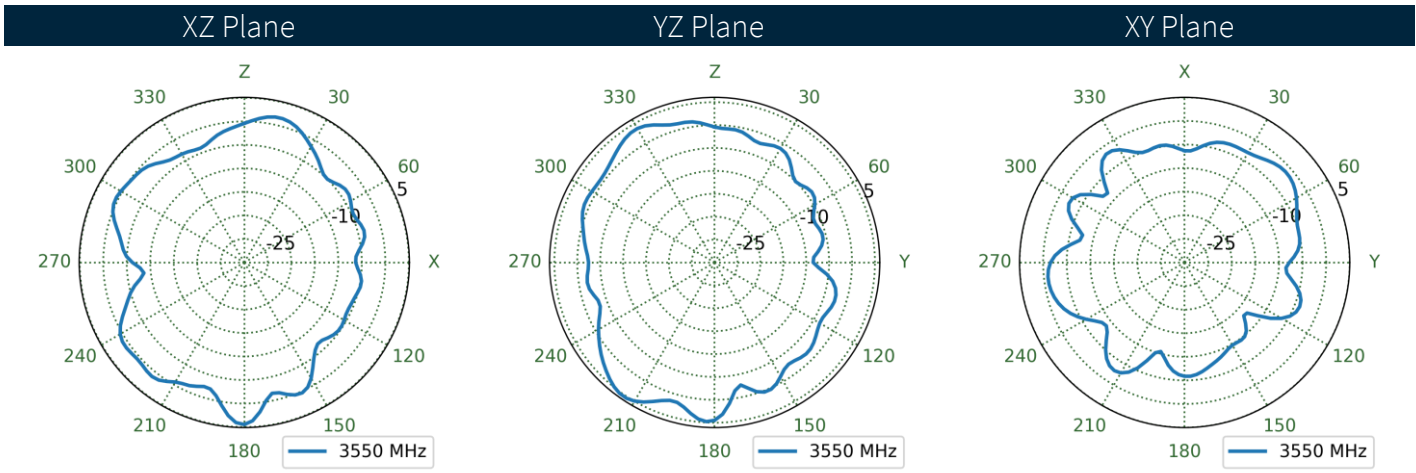
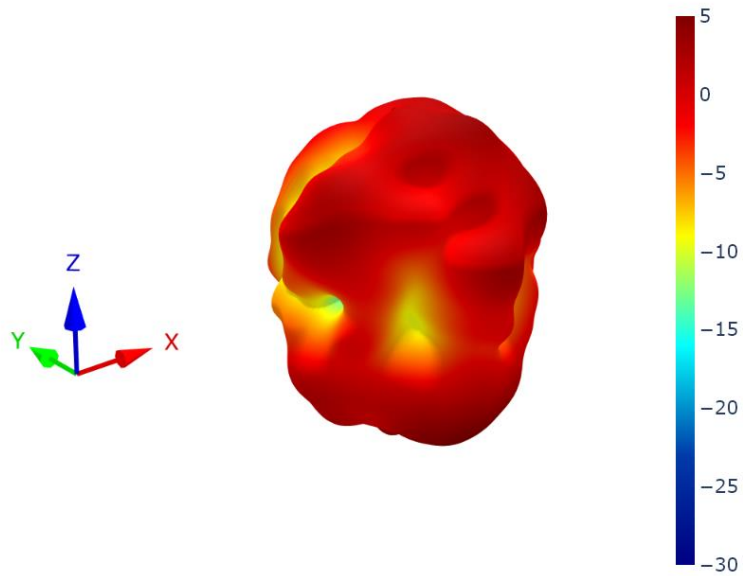

5.41 LTE4 Patterns at 3550 MHz

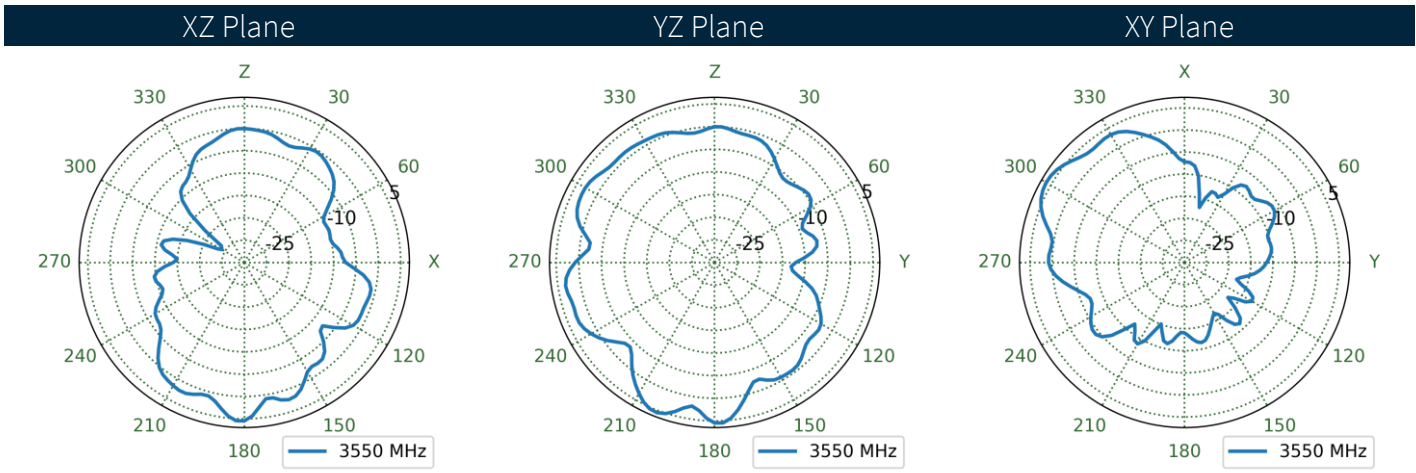
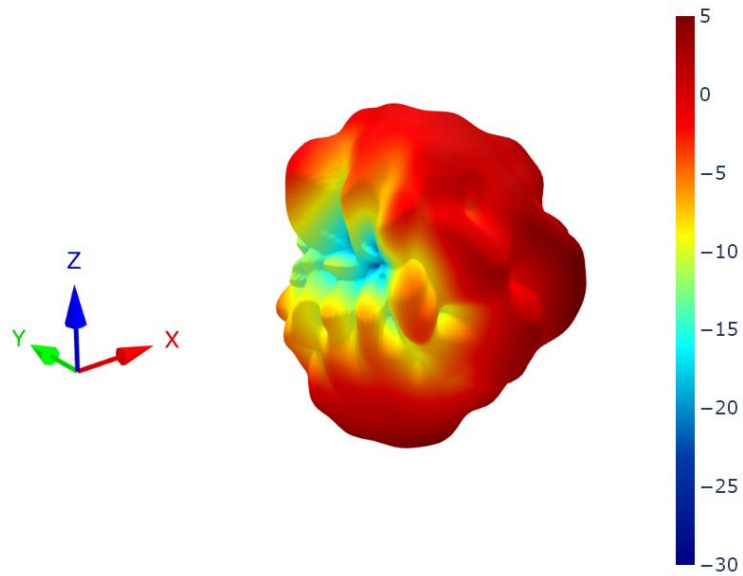

5.42 LTE1 Patterns at 4600 MHz

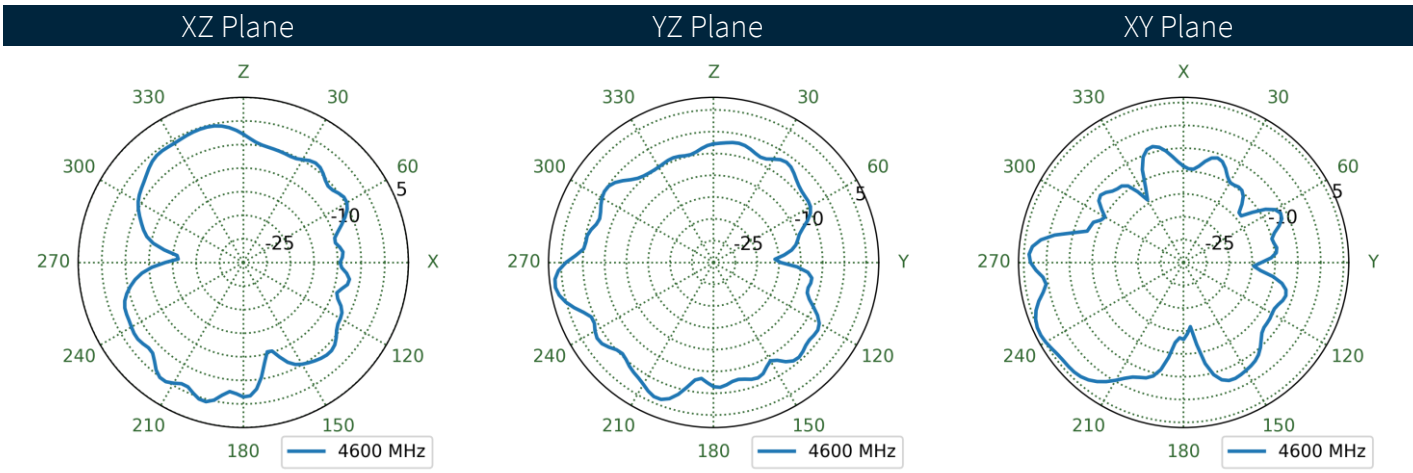
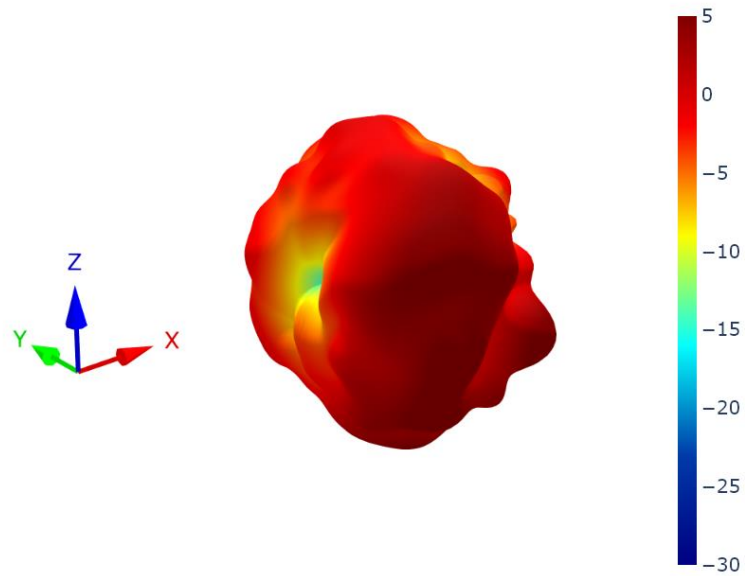

5.43 LTE2 Patterns at 4600 MHz

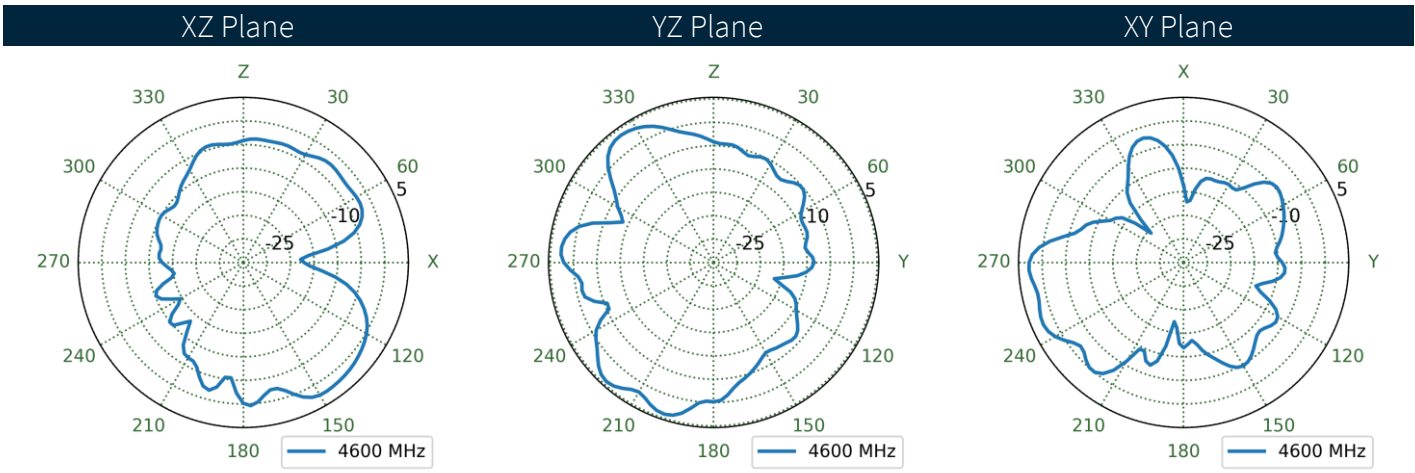
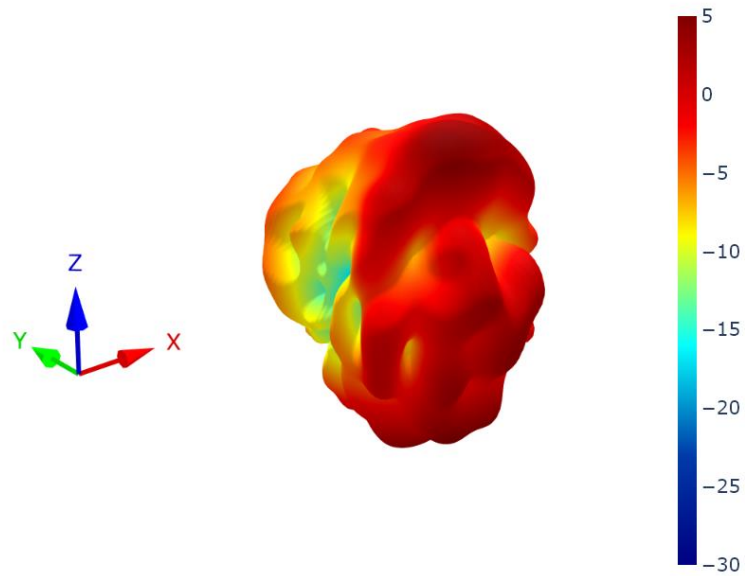

5.44 LTE3 Patterns at 4600 MHz

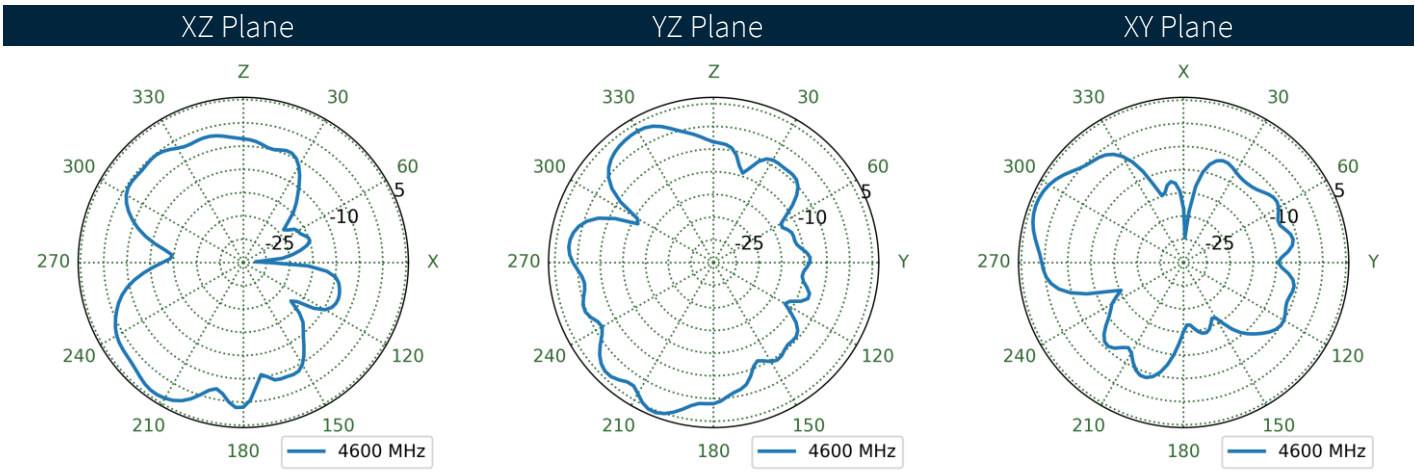
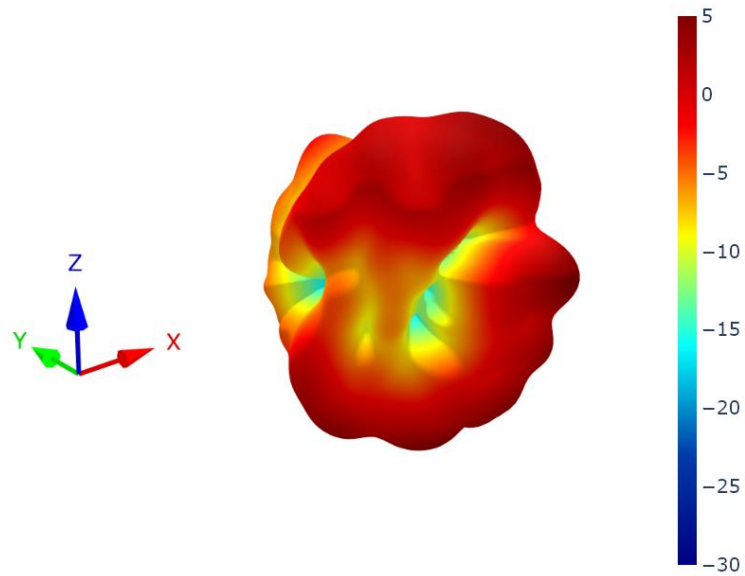

5.45 LTE4 Patterns at 4600 MHz

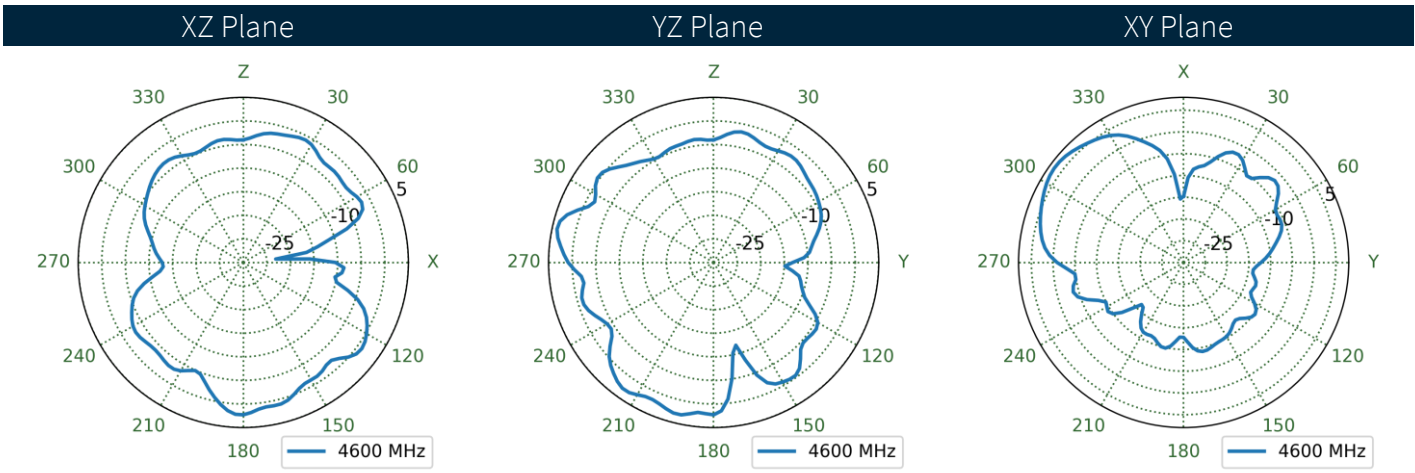
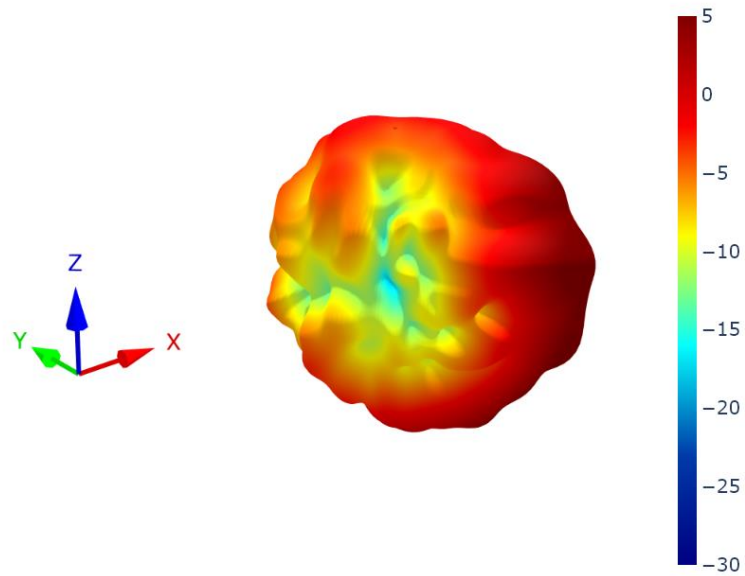

5.46 LTE1 Patterns at 4800 MHz

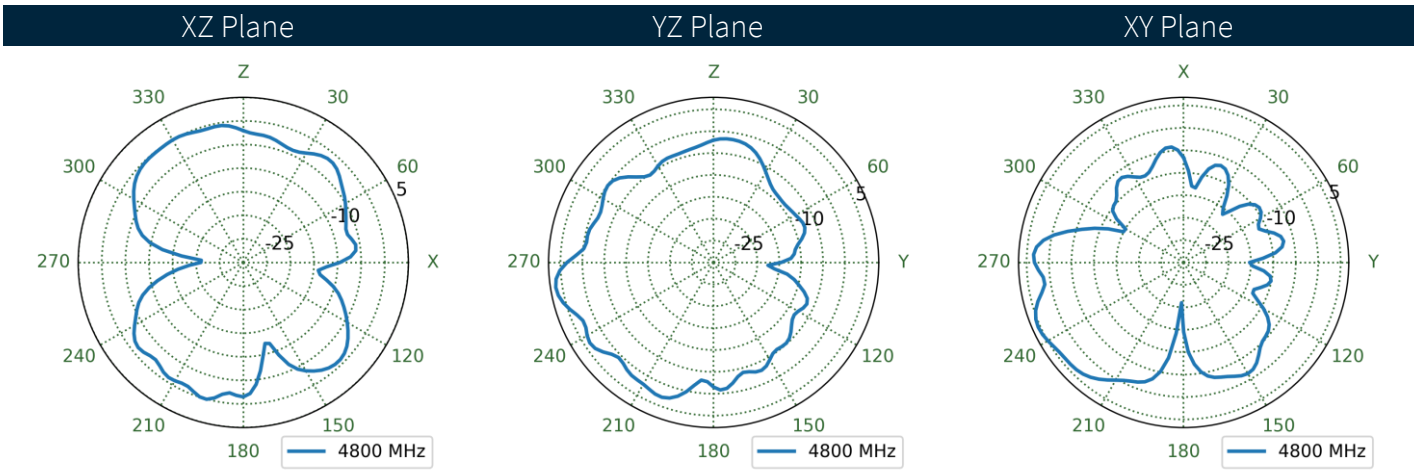
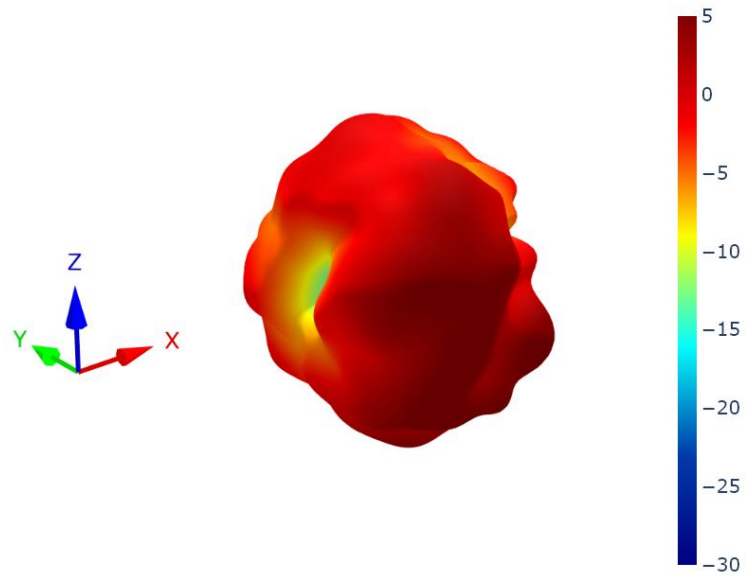

5.47 LTE2 Patterns at 4800 MHz

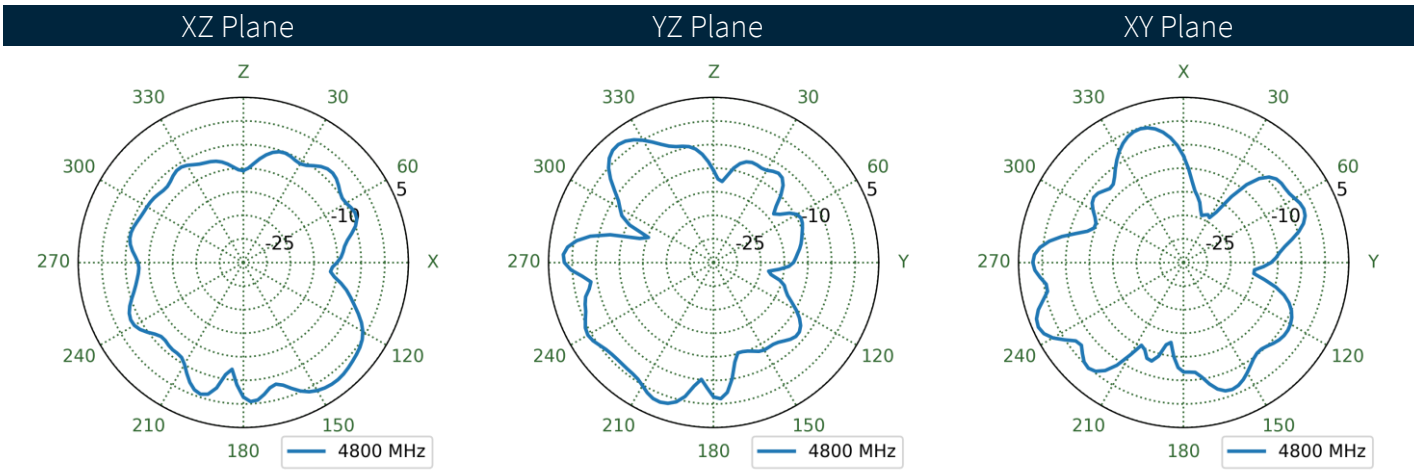
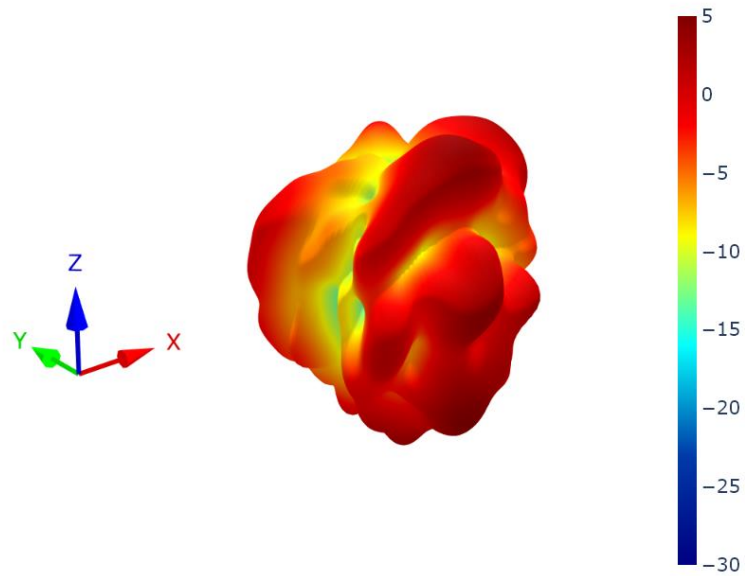

5.48 LTE3 Patterns at 4800 MHz

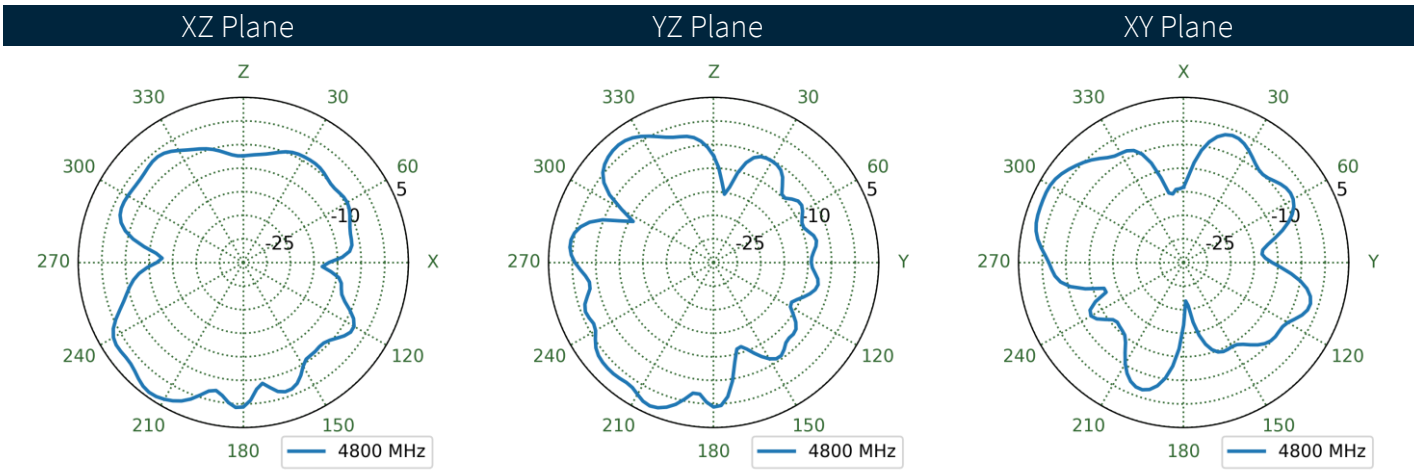
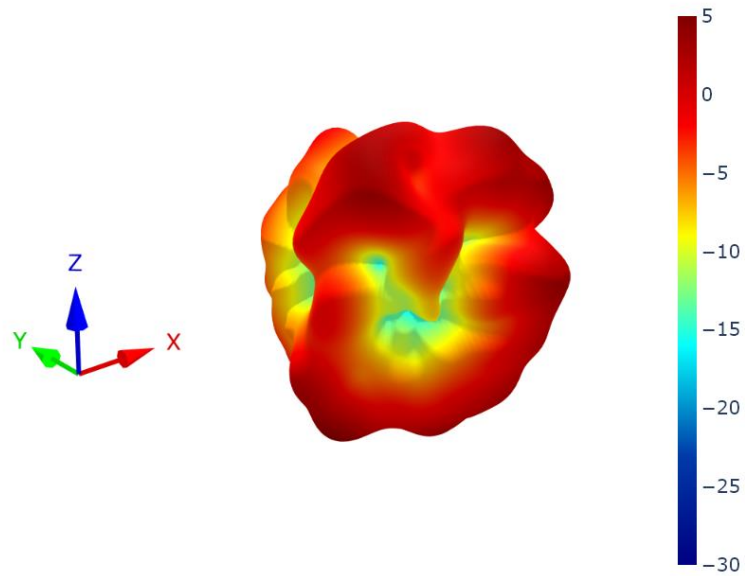

5.49 LTE4 Patterns at 4800 MHz

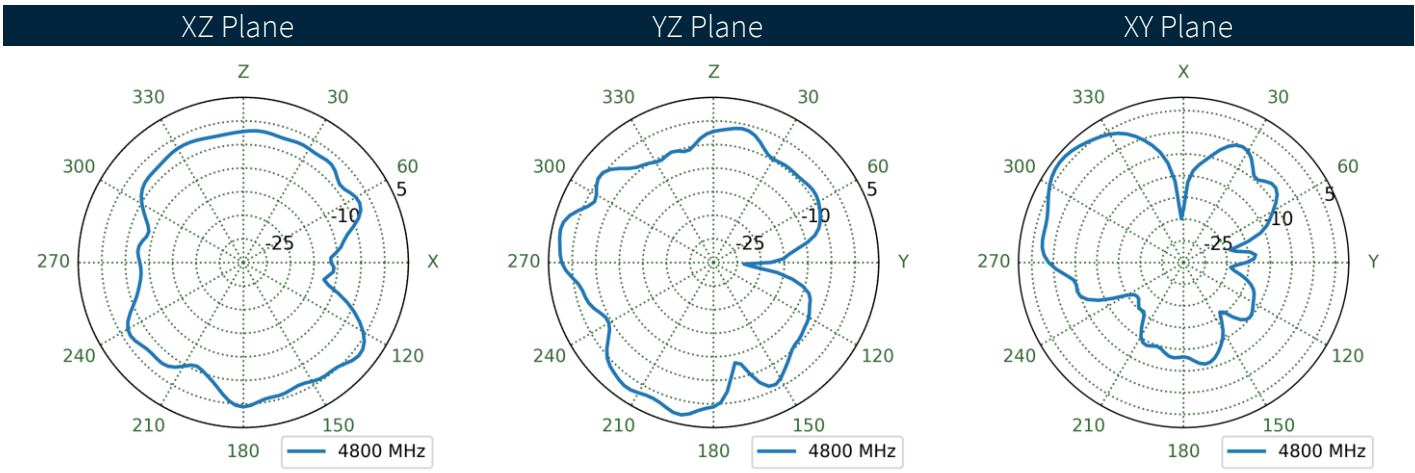
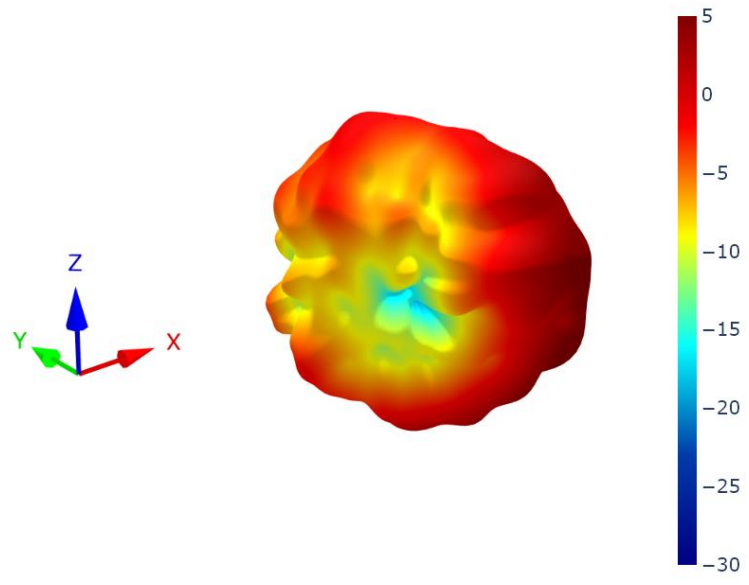

5.50 LTE1 Patterns at 5530 MHz

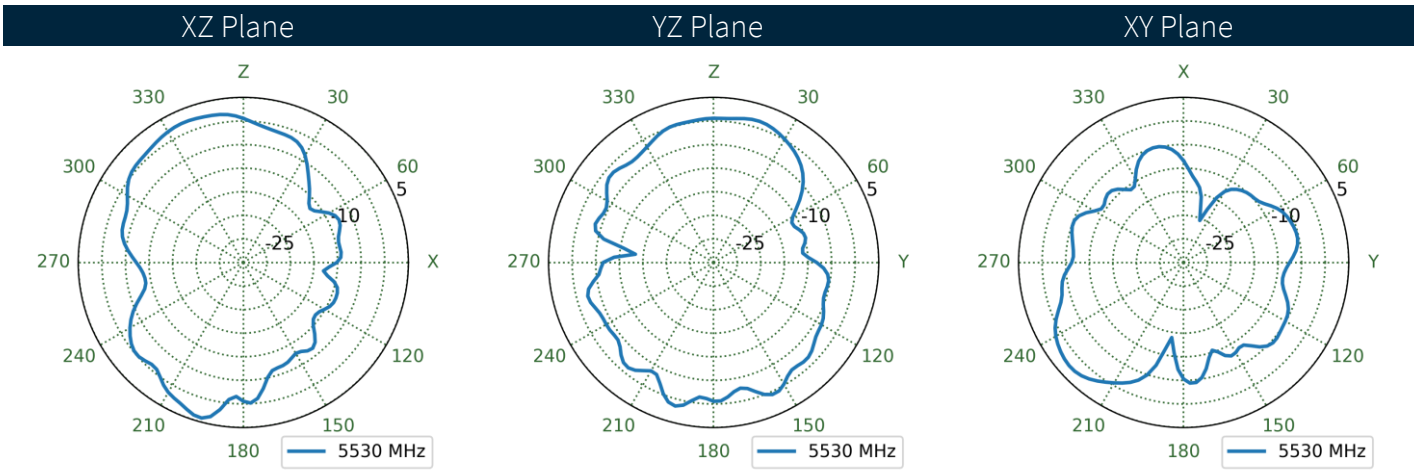
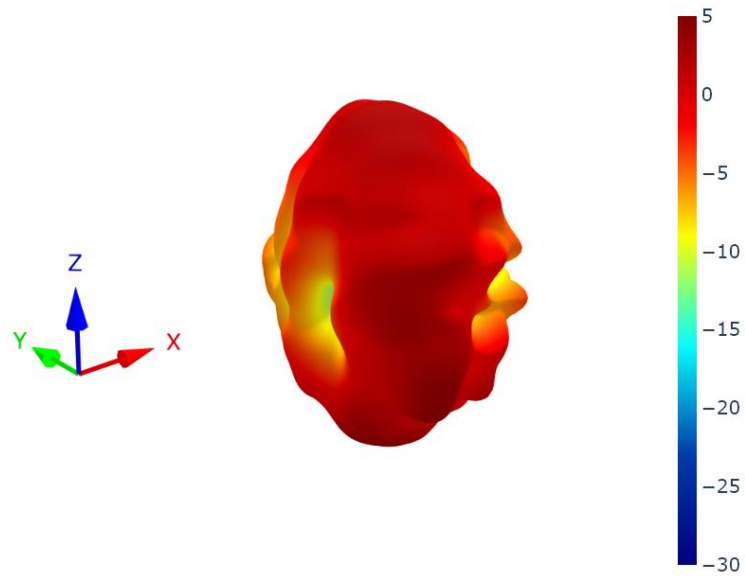

5.51 LTE2 Patterns at 5530 MHz

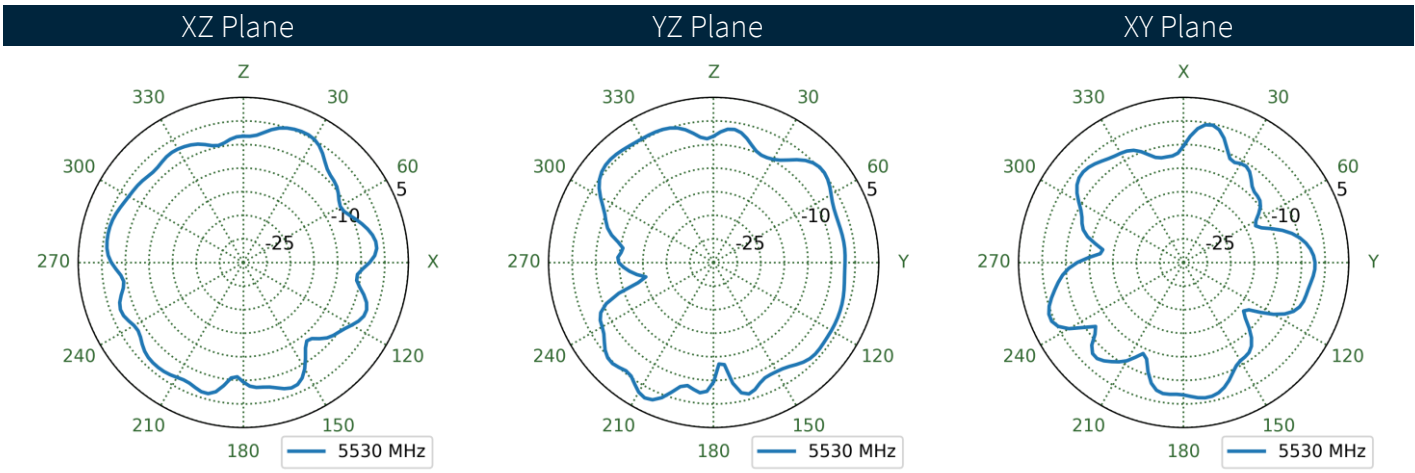
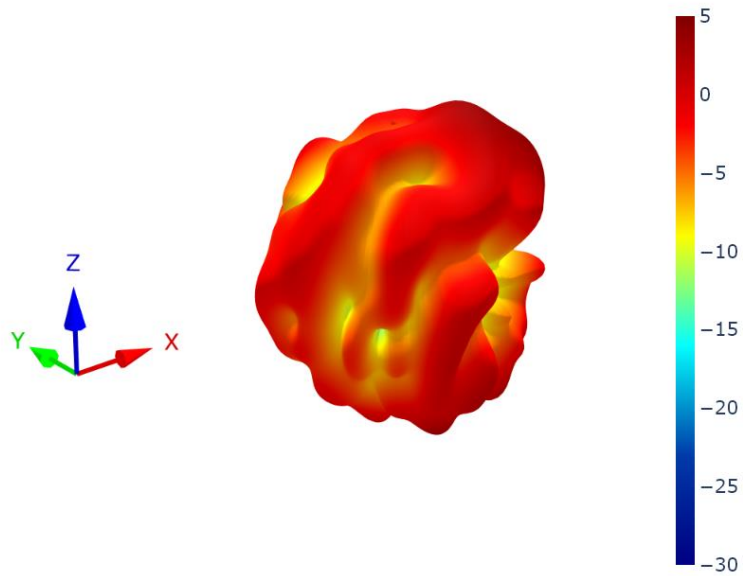

5.52 LTE3 Patterns at 5530 MHz

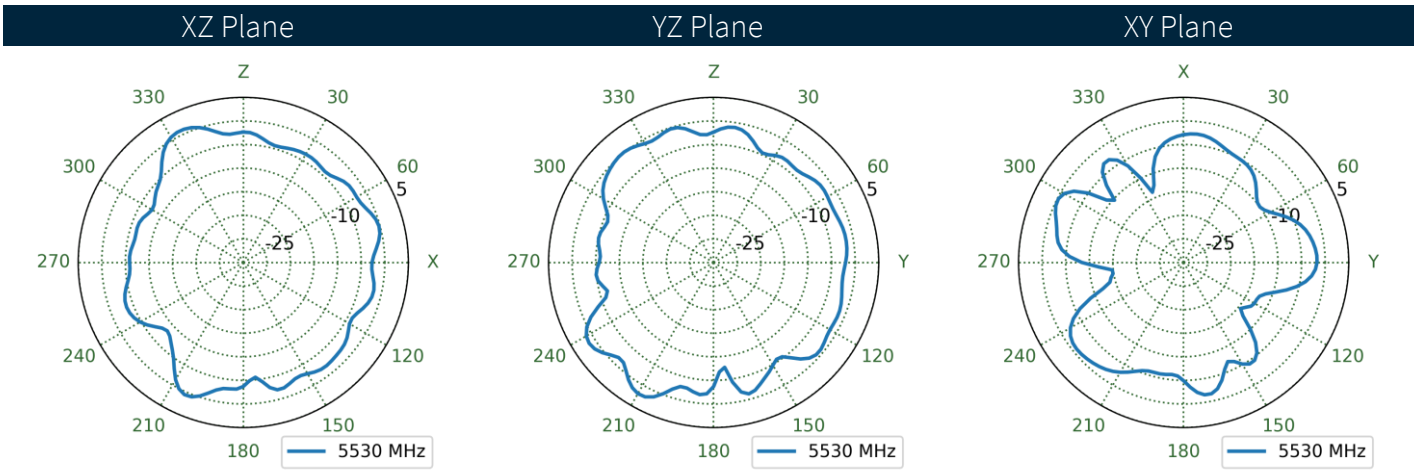
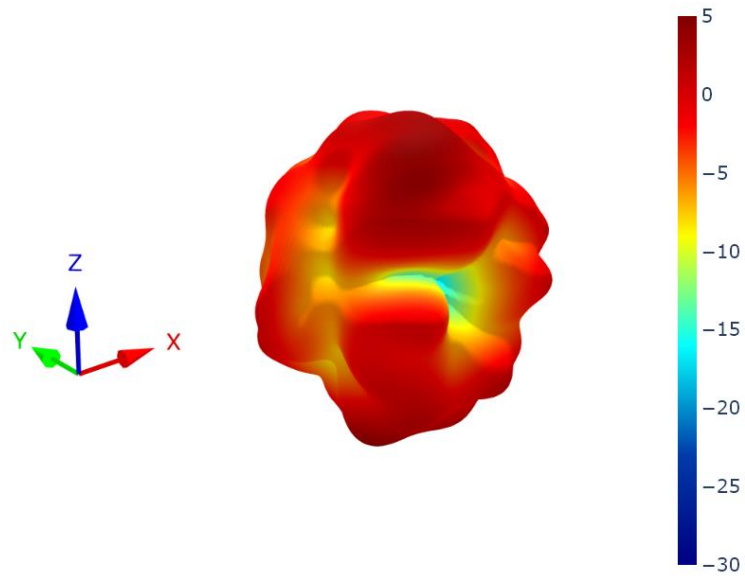

5.53 LTE4 Patterns at 5530 MHz

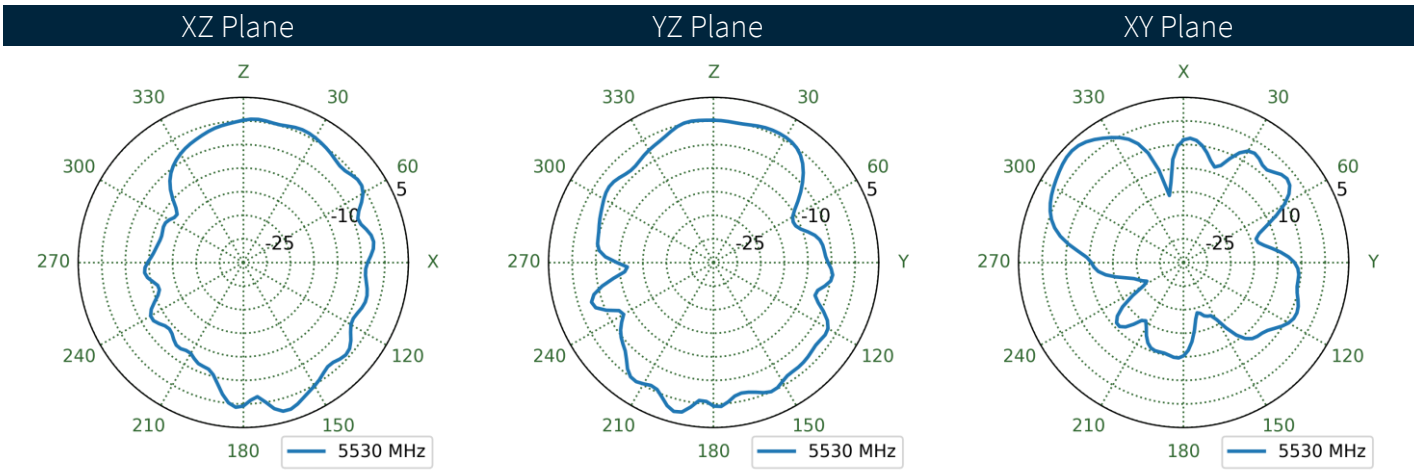
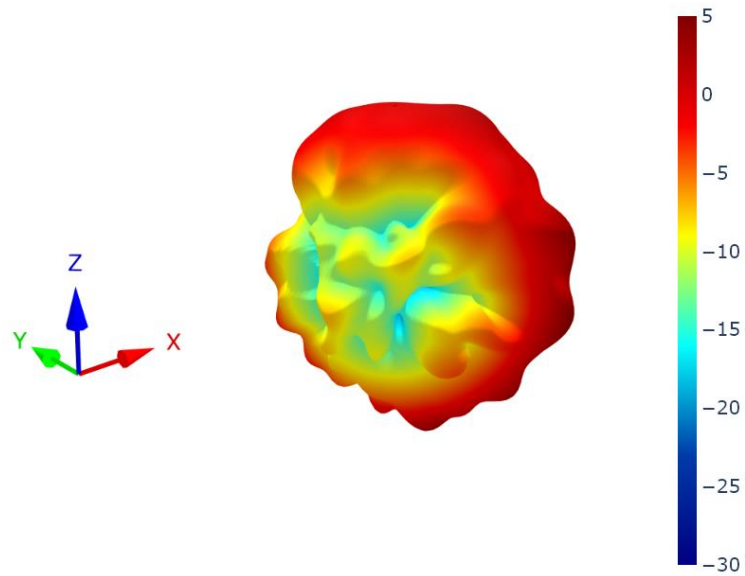

5.54 Wi-Fi1 Patterns at 2450 MHz

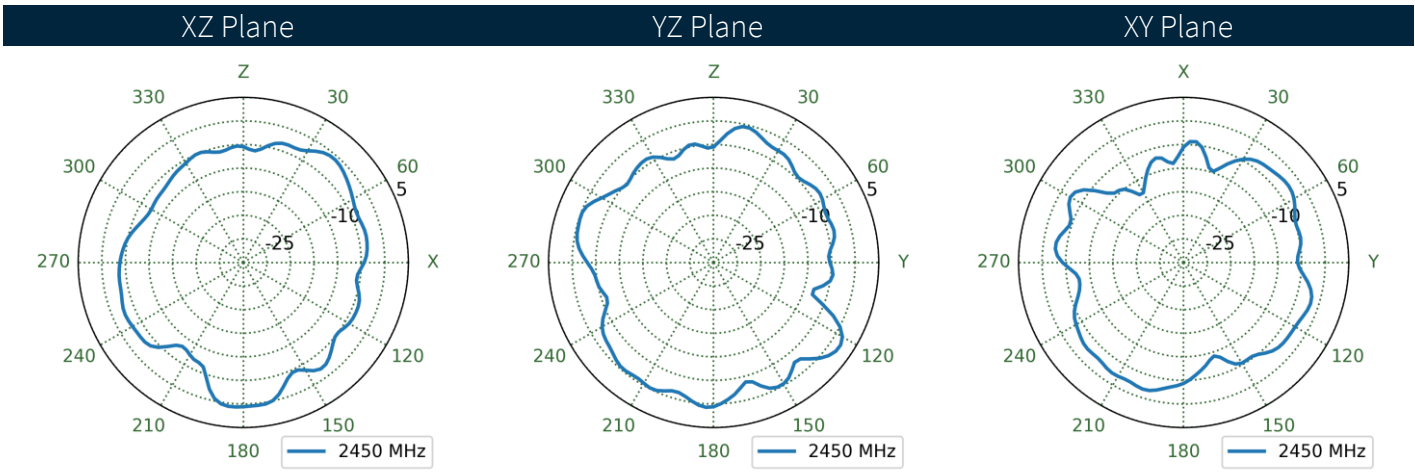
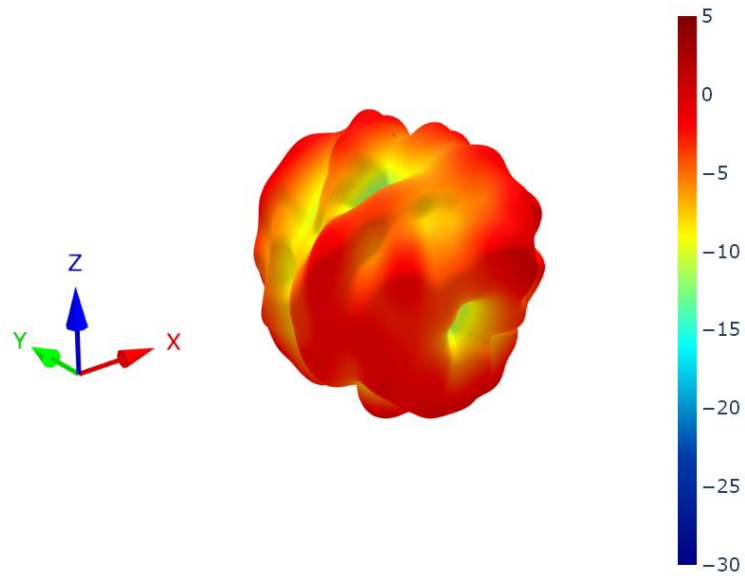

5.55 Wi-Fi2 Patterns at 2450 MHz

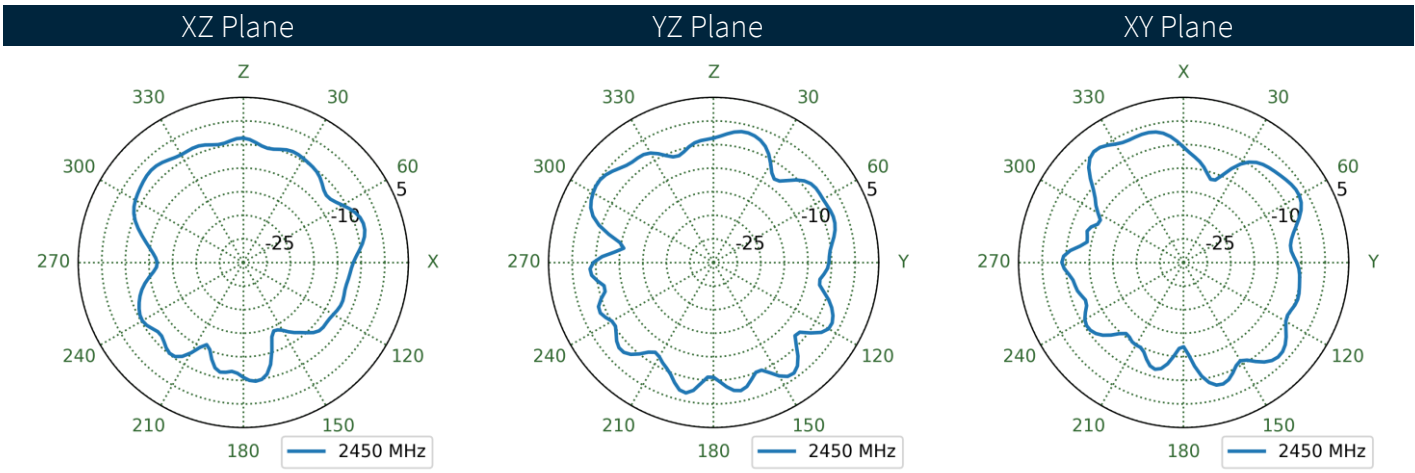
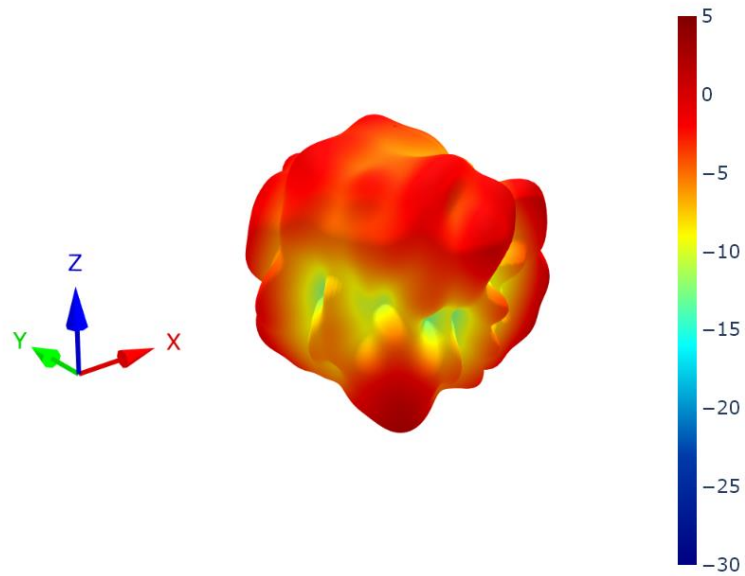

5.56 Wi-Fi1 Patterns at 5500 MHz

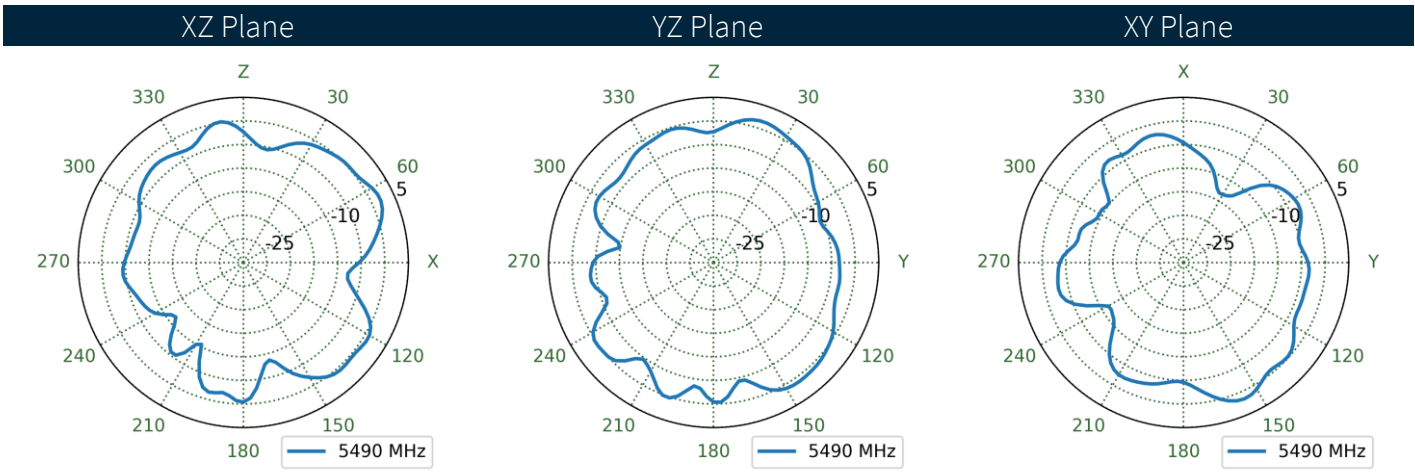
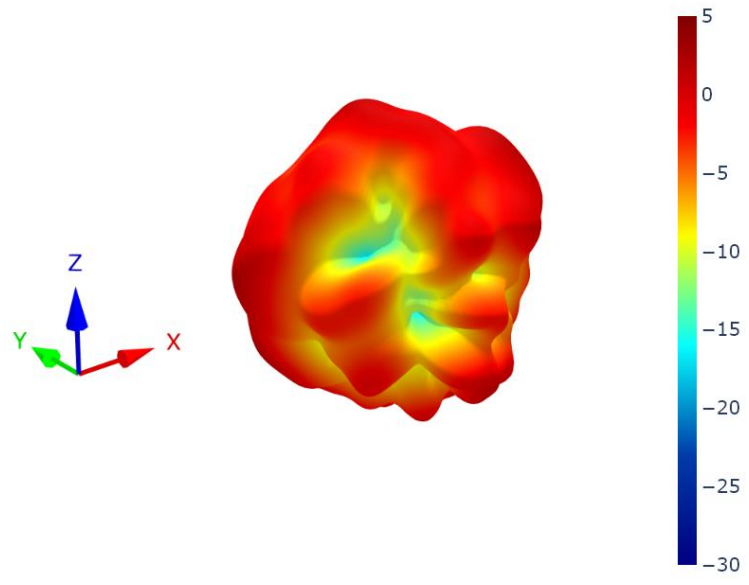

5.57 Wi-Fi2 Patterns at 5500 MHz

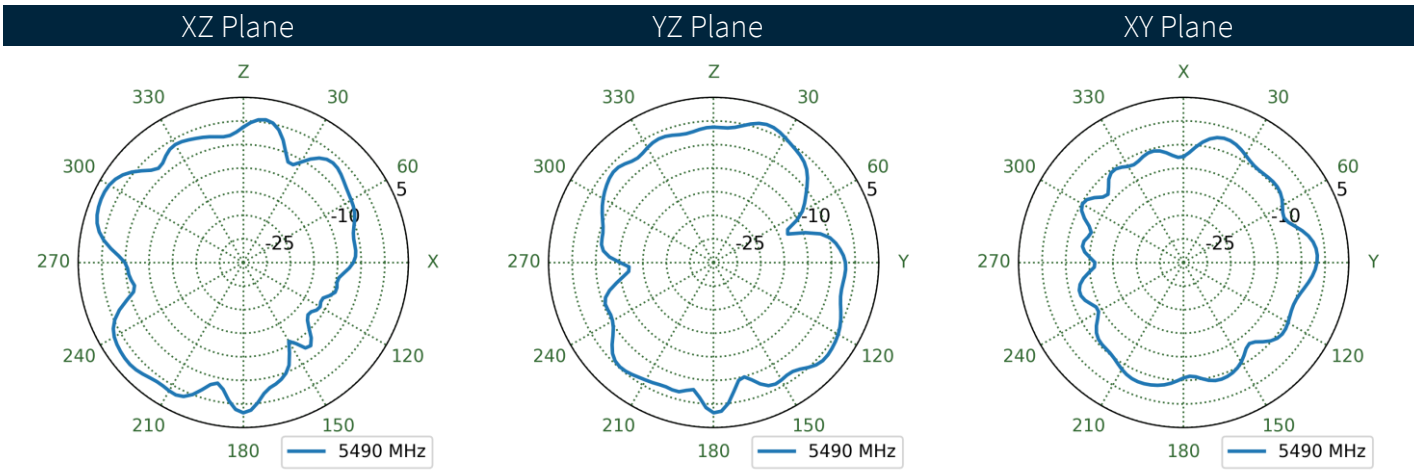
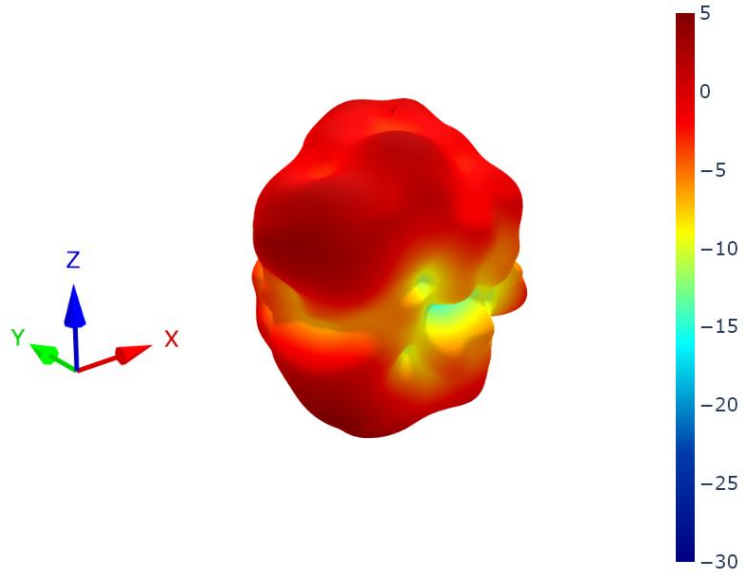

5.58 Wi-Fi1 Patterns at 6525 MHz

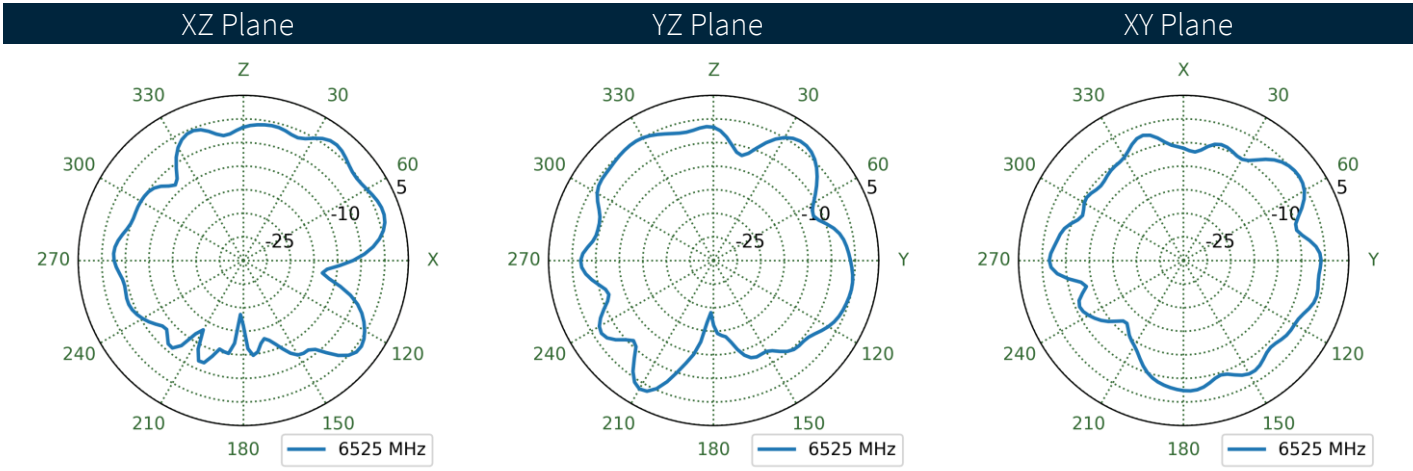
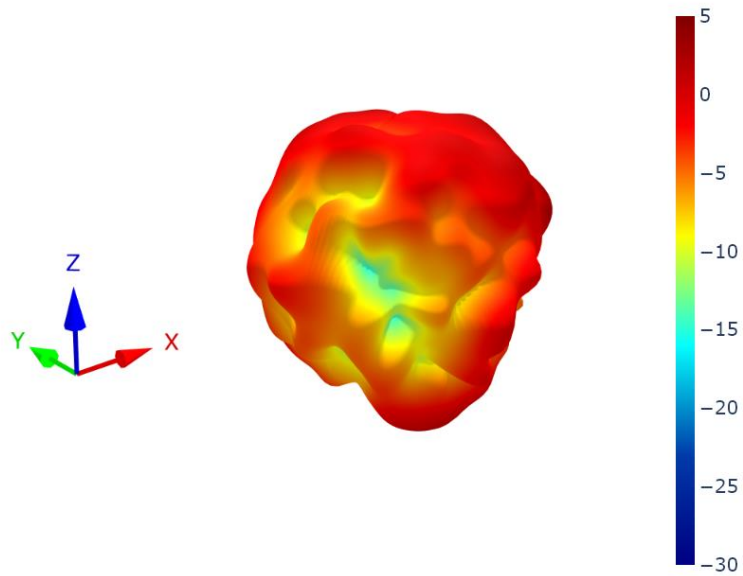

5.59 Wi-Fi2 Patterns at 6525 MHz

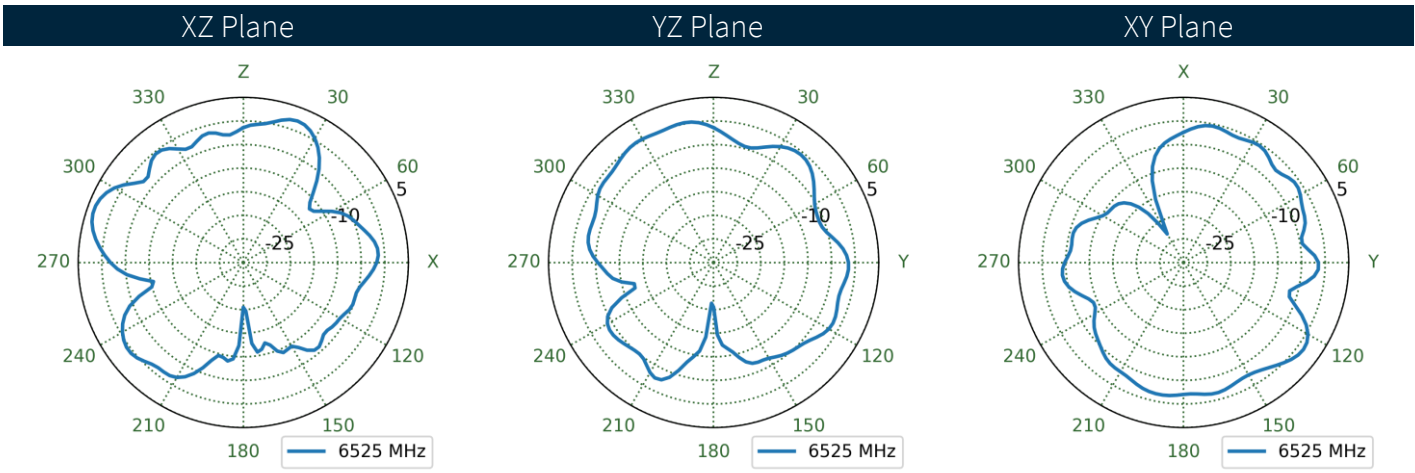
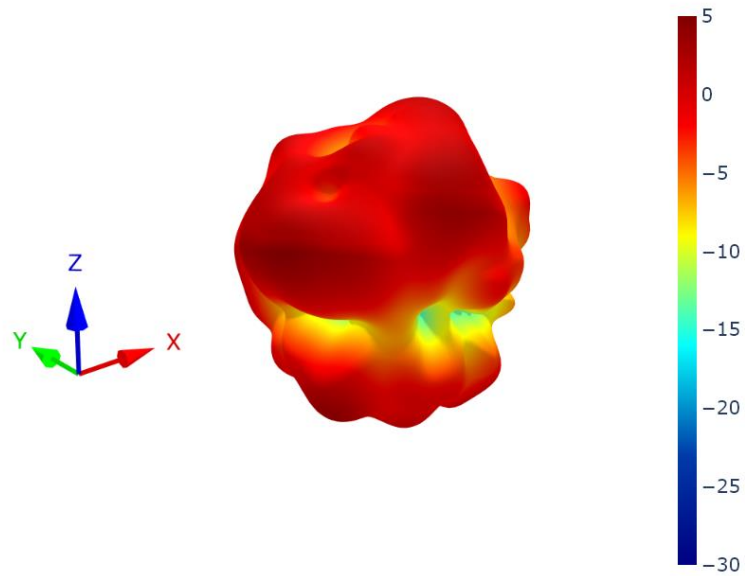

6. Packaging



1 PCS / Zipper bag



1 PCS / PE bag

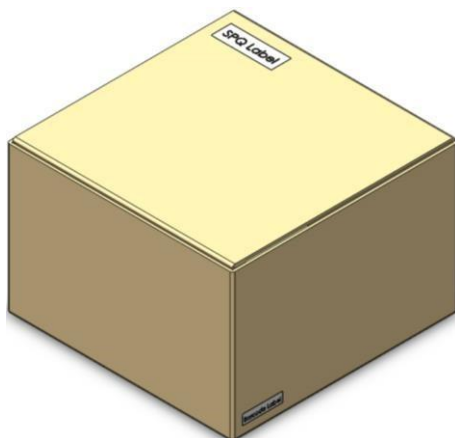

- Box (mm): 260x235x105
- SPQ Label
- Barcode Label
- Weight (Kg): 0.74 ±3%

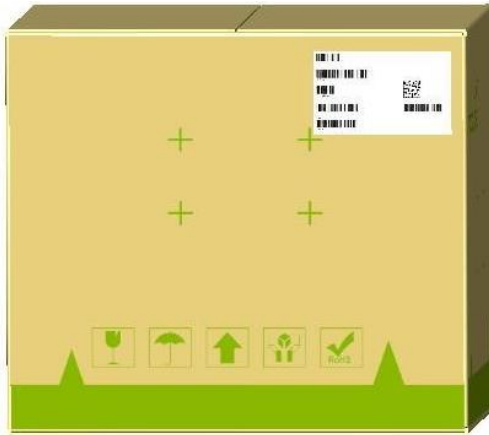

- 6 PCS / Carton
- Carton(mm): 475x272x325
- Carton Label
- Weight (Kg): 5.21 ±3%

Changelog for the datasheet

SPE-24-8-137-A - MA996.A.003

Revision: B (Current Version)

Date:	2024-11-13
Notes:	Updated product image
Author:	Conor McGrath

Previous Revisions

Revision: A (Original First Release)

Date:	2024-08-01
Notes:	Initial Release
Author:	David Connolly



www.taoglas.com



X-ON Electronics

Largest Supplier of Electrical and Electronic Components

Click to view similar products for [Antennas](#) category:

Click to view products by [Taoglas](#) manufacturer:

Other Similar products are found below :

[930-033-R](#) [108-00014-50](#) [66089-2406](#) [A09-F8NF-M](#) [A09-F5NF-M](#) [RGFRA1903041A1T](#) [W1049B090](#) [WTL2449CQ1-FRSMM](#) [CPL9C](#)
[0600-00060](#) [PAL90209H-FNF](#) [GD53-25](#) [S9025PLSMF](#) [GPSCPMM00](#) [ANTDOM-05-01-WPM](#) [ANT-WP868SMA-Y](#) [CBNC58](#) [ABFT](#)
[LP800NMOW](#) [NMOQ88C](#) [NMOQB](#) [NMOQC](#) [ANT-GSMGPSPUKS](#) [60210](#) [60140](#) [ANT-8WPIG-UFL](#) [ANT-GPSPUKS](#) [A21H0](#) [29000863](#)
[29000848](#) [955179003](#) [RFANT2012090A0T](#) [RGFRA3216110A5T](#) [22100003](#) [DL-T022-2.4G](#) [DL-T023-4G](#) [T1-915M](#) [DL-T021-2.4GW](#) [DL-](#)
[T021-2.4G](#) [KH-IPEX-1.13](#) [BWGNXCX16-6B1Y2L120](#) [BWGNXCX15-15B1Y4L120](#) [DL-T023-4GW](#) [DL-J020-433M](#) [J008-GSM](#)
[3N0401LG-021](#) [KHA\(RG1.13\)-TX90B-IPEX](#) [KH-GPS181804-WY](#) [KHA\(RG1.13\)-TX80B-IPEX](#) [TX5800-JZ-5](#)