



TAOGLAS®



Datasheet

Raptor X Series

Part No:
MA8005.A.001

Description

Raptor X - 5-in-1 Screwmount Antenna with GNSS - 2m RG-174, SMA(M)
and 4* 5G/4G – 2m TGC-302, SMA(M)

Features:

- 1* GNSS Covering L1/L5 Bands
- 4* 5G/4G Cellular Covering 600-6000MHz
- Dimensions : 350mm x 70mm x 39mm
- M22 Thread Mount
- IP69K Rated Enclosure
- Cables: GNSS with 2m RG-174 and 5G/4G with 2m TGC-302
- IK10 Rated Enclosure
- Connector: GNSS with SMA(M) and 5G/4G with SMA(M)
- Custom Cables and Connectors Available
- RoHS & Reach Compliant

1.	Introduction	3
2.	Specification	4
3.	Mechanical Drawing	8
4.	Installation Guide	9
5.	Packaging	10
6.	Antenna Characteristics	11
7.	LNA Characteristics	17
8.	Radiation Patterns	19
<hr/>		
	Changelog	74

Taoglas makes no warranties based on the accuracy or completeness of the contents of this document and reserves the right to make changes to specifications and product descriptions at any time without notice. Taoglas reserves all rights to this document and the information contained herein. Reproduction, use or disclosure to third parties without express permission is strictly prohibited.

Ireland & USA
ISO 9001:2015
Certified



Taiwan
ISO 9001:2015
Certified



1. Introduction



Introducing the Taoglas Raptor X MA8005, a low-profile, sleek, 5-in-1 combination antenna engineered for the next generation of routers and gateways. The advanced combination antenna offers dual-band GNSS L1/L5 for exceptional navigational positional accuracy and high-efficiency 5G/4G wideband cellular MIMO connectivity spanning 600-6000MHz for superior mobile connectivity.

The Raptor X boasts a compact form factor of just 350 x 70 x 39mm, setting a new market standard for products containing up to 10 antennas. With a height of only 39mm, it is ideal for vehicle roof installations where height constraints are common, typically below 80mm. Its sleek, 70mm design allows it to fit seamlessly on various NEMA cabinets and between the ribs on many vehicle roofs. The MA8005 has an extremely robust IP69K rated enclosure allowing for the most demanding of use cases and applications.

Typical applications include:

- Emergency and First Responder Vehicles
- EV Charger Stations
- Smart Industry and Warehouse Applications
- Private LTE Networks

The MA8005, part of the Raptor X series, offers customization with up to ten connections, one GNSS, four cellular, and five Wi-Fi antennas tailored for specific routers and customer configurations. All cables and connectors can be fully customized to meet your unique requirements.

For further information on how to integrate the Raptor X or for orders, please contact your regional Taoglas customer support team.

2. Specification

GNSS Frequency Bands					
GPS	L1 1575.42 MHz	L2 1227.6 MHz	L5 1176.45 MHz		
	■	□	■		
GLONASS	G1 1602 MHz	G2 1248 MHz	G3 1207 MHz		
	■	□	□		
Galileo	E1 1575.24 MHz	E5a 1176.45 MHz	E5b 1201.5 MHz	E6 1278.75 MHz	
	■	■	□	□	
BeiDou	B1C 1575.42 MHz	B1I 1561 MHz	B2a 1176.45 MHz	B2b 1207.14 MHz	B3 1268.52 MHz
	■	■	■	□	□
L-Band	L-Band 1542 MHz				
	□				
QZSS (Regional)	L1 1575.42 MHz	L2C 1227.6 MHz	L5 1176.45 MHz	L6 1278.75e6	
	■	□	■	□	
IRNSS (Regional)	L5 1176.45 MHz				
	■				
SBAS	L1/E1/B1 1575.42 MHz	L5/B2a/E5a 1176.45 MHz	G1 1602 MHz	G2 1248 MHz	G3 1207 MHz
	■	■	■	□	□

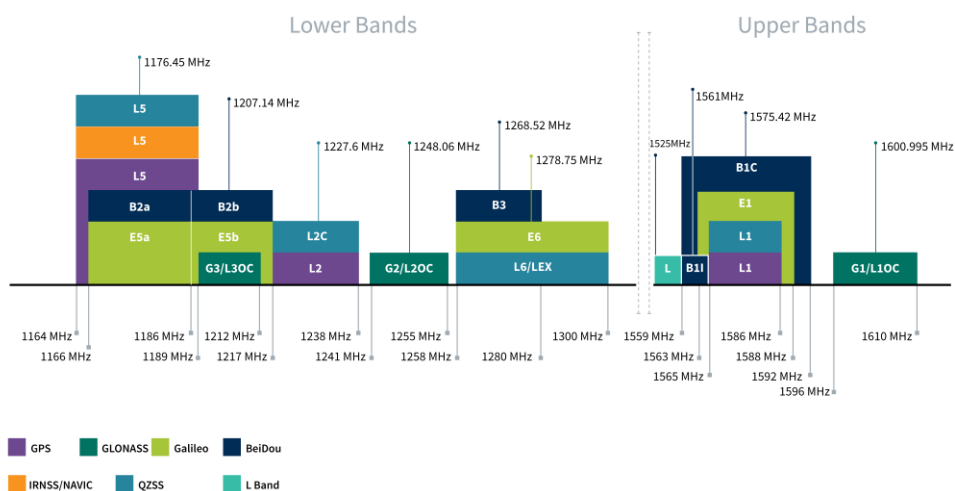

Bands and Constellations Table

GNSS Electrical				
Frequency (MHz)	GPS_L5	BeiDou_B1	GPS_L1	GLONASS_G1
	1164-1189	1559-1592	1565-1586	1596-1610
Average Gain (dB)	-2.95	-2.00	-1.77	-2.62
Efficiency (%)	50.7	63.0	66.5	54.7
Peak Gain (dBi)	2.49	3.93	3.93	3.38
Axial Ratio at Zenith	5	4.8	11.7	13.1
Impedance	50 Ω			
Polarization	RHCP			

LNA and Fi5G/4Gr Electrical Properties (3.3V Typ.)			
Frequency (MHz)		High-Band	Low-Band
LNA Gain (dB)		32.3	26.3
Current Consumption (mA)		16.8	
Outer Band Attenuation (dB)	At 500 ~ 1000 MHz	60 dB	
	At 2000 ~ 2690MHz	60 dB	
	At 3300~ 6000MHz	60 dB	
Output Impedance		50 ohm	
Input Voltage(V)		+1.8 to 5.5	

5G/4G Electrical								
Band	Frequency (MHz)	Set-up	Efficiency (%)	Average Gain (dB)	Peak Gain (dBi)	Impedance	Polarization	Radiation Pattern
5G NR Band 71	617-698	5G/4G-1	49.8	-3.03	0.87	50 Ω	Linear	Omni
		5G/4G-2	36.6	-4.37	0.91			
		5G/4G-3	36.4	-4.38	1.03			
		5G/4G-4	44.5	-3.52	2.25			
5G/4G700	698-824	5G/4G-1	49.7	-3.04	2.94			
		5G/4G-2	39.5	-4.03	2.11			
		5G/4G-3	35.4	-4.51	1.97			
		5G/4G-4	50.3	-2.99	2.25			
GSM800 900	824-960	5G/4G-1	50.8	-2.94	2.64			
		5G/4G-2	43.7	-3.60	2.18			
		5G/4G-3	37.5	-4.26	2.17			
		5G/4G-4	48.0	-3.19	2.25			
5G NR Band 1500	1427-1518	5G/4G-1	27.9	-5.54	1.01			
		5G/4G-2	27.8	-5.56	1.21			
		5G/4G-3	24.5	-6.10	1.11			
		5G/4G-4	26.7	-5.74	0.99			
5GNR N66	1710-2200	5G/4G-1	47.7	-3.21	5.15			
		5G/4G-2	53.7	-2.70	5.44			
		5G/4G-3	51.2	-2.91	5.63			
		5G/4G-4	42.5	-3.72	4.65			
5G/4G2600	2300-2690	5G/4G-1	45.2	-3.45	6.16			
		5G/4G-2	56.8	-2.45	6.97			
		5G/4G-3	52.6	-2.79	6.72			
		5G/4G-4	47.0	-3.28	6.15			
5GNR N77	3300-4200	5G/4G-1	63.8	-1.95	6.23			
		5G/4G-2	63.1	-2.00	6.78			
		5G/4G-3	59.7	-2.24	7.74			
		5G/4G-4	61.2	-2.13	5.97			
5GNR N78	3300-3800	5G/4G-1	64.2	-1.92	6.23			
		5G/4G-2	63.5	-1.97	6.78			
		5G/4G-3	60.3	-2.20	7.74			
		5G/4G-4	61.7	-2.10	5.97			
5GNR N79	4400-5000	5G/4G-1	49.9	-3.02	5.49			
		5G/4G-2	51.2	-2.91	6.77			
		5G/4G-3	52.9	-2.76	5.80			
		5G/4G-4	45.4	-3.43	5.96			
5G/4G5200	5150-5925	5G/4G-1	48.9	-3.11	5.76			
		5G/4G-2	41.2	-3.86	4.93			
		5G/4G-3	43.5	-3.62	6.48			
		5G/4G-4	40.1	-3.97	4.44			

*Tested with 0.3m of Cable on a 30x30cm Ground Plane

Mechanical	
Dimensions	350mm * 70mm * 39 mm
Weight	0.76Kg
Material	PC
Connector	GNSS: SMA(M), 5G/4G: SMA(M)
Cable	GNSS: 2m of RG-174, 5G/4G: 2m of TGC-302
Enclosure Impact Rating	IK10

Environmental	
Waterproof Rating	IP69K
Temperature Range	-40°C to + 85°C
Humidity	Non-condensing 65°C 95% RH

3. Mechanical Drawing

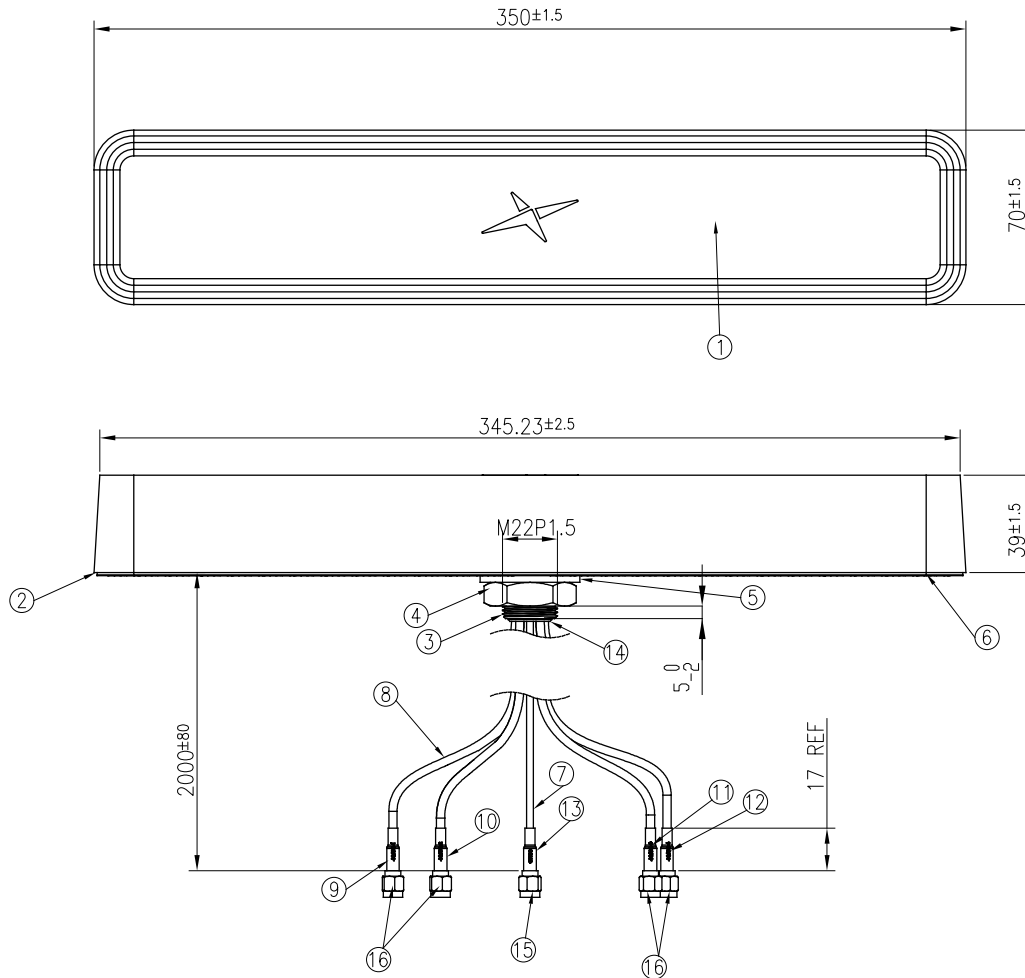

	Name	Material	Finish	QTY
1	Top Housing	PC	Black	1
2	Bottom Housing	PC	Black	1
3	Metal Stem	Zinc Alloy	Ni Plated	1
4	Nut_M22x1.5P	Steel	Ni-Zn Plated	1
5	Washer_M22	Steel	Ni-Zn Plated	1
6	Double Side Adhesive	3M 9448HK + CR4305 2t	Black	1
7	RG174 Coaxial Cable	PVC	Black	1
8	TGC-302 Cable	PVC	Black	4
9	Heat Shrink Tube(4G/5G-1)	PE	Red Tube/White Text	1
10	Heat Shrink Tube(4G/5G-2)	PE	Red Tube/White Text	1
11	Heat Shrink Tube(4G/5G-3)	PE	Red Tube/White Text	1
12	Heat Shrink Tube(4G/5G-4)	PE	Red Tube/White Text	1
13	Heat Shrink Tube(GNSS)	PE	Blue Tube/White Text	1
14	Grommet_MA8957/MA8955_	USilicon, NE-7150, HS-50A +/- 5%	Black	1
15	SMA(M) ST_RG174	Brass	Au Plated	1
16	SMA(M) ST_TGC302	Brass	Au Plated	4

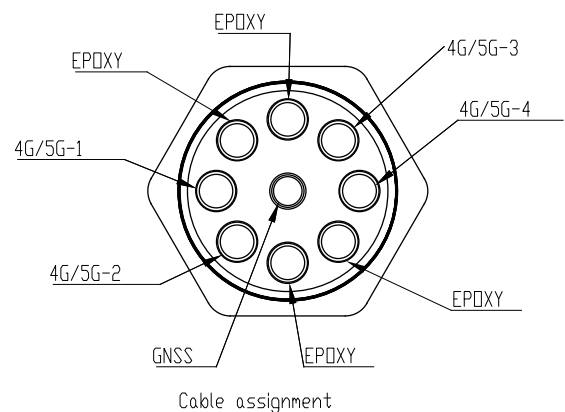

4. Installation Guide

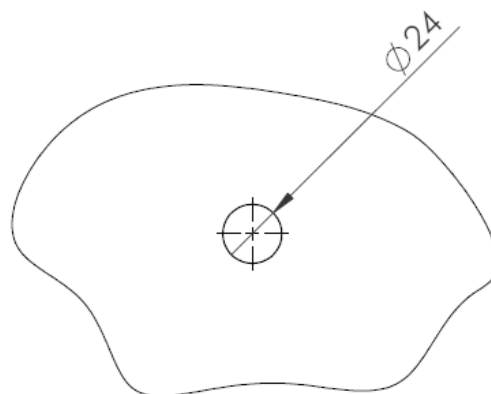
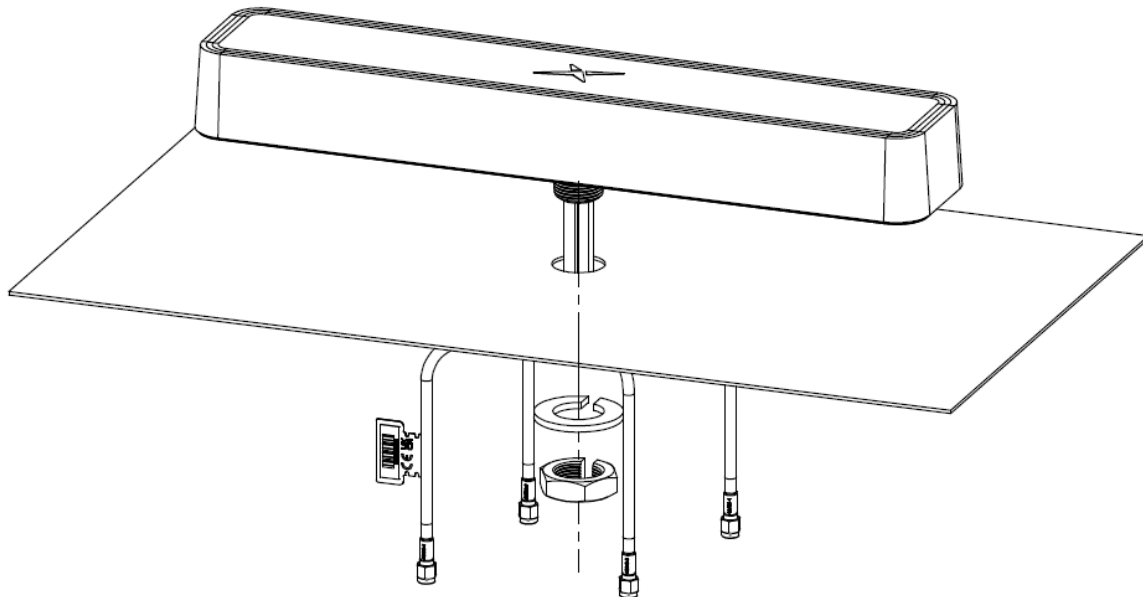

RECOMMENDED HOLE SIZE FOR MOUNTING
 MAX PANEL THICKNESS = 6MM

5. Packaging

1pc MA8005.A.001 per PE Bag
Weight: 0.76Kg

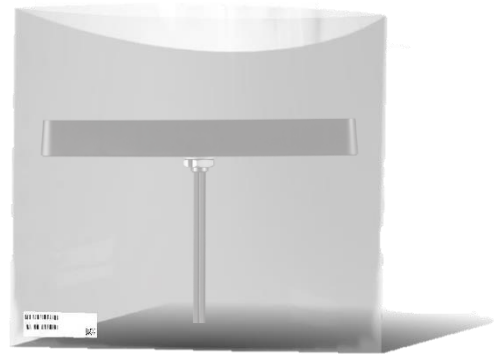

10pcs MA8005.A.001 per carton
Dimensions 370 x 370 x 300mm
Weight:8.7Kg



6. Antenna Characteristics

6.1 Test Setup

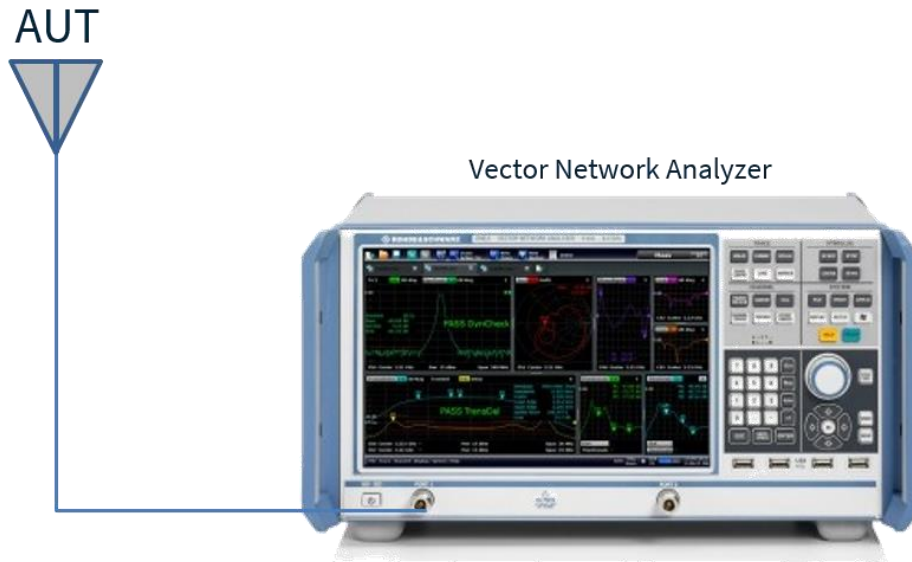

VNA Test Set up

6.2 Return Loss (GNSS)

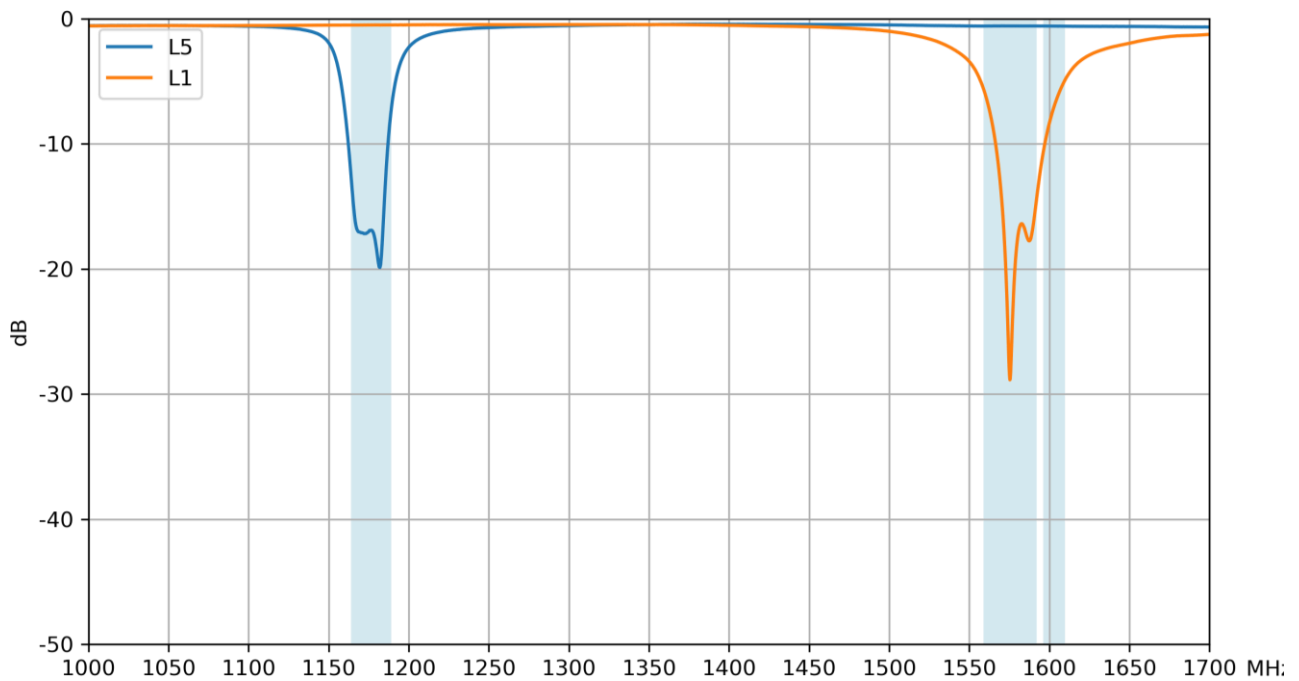

6.3 Efficiency (GNSS)

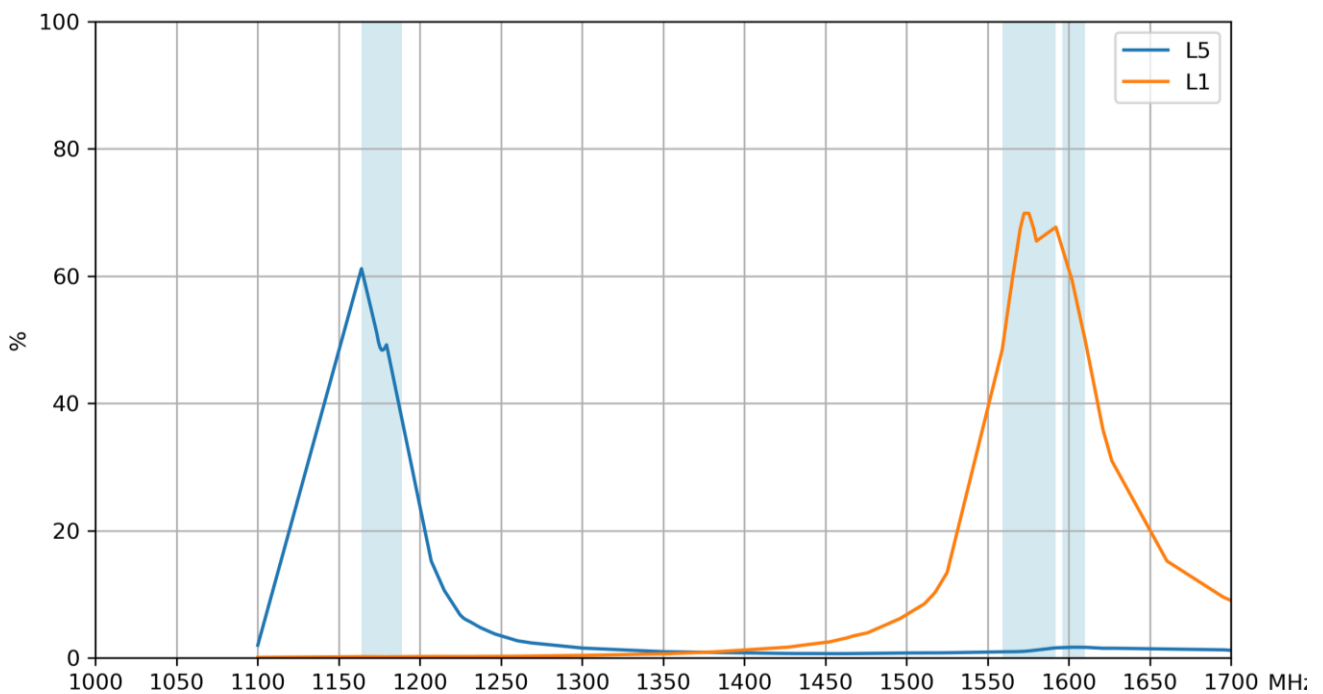

6.4 Average Gain (GNSS)

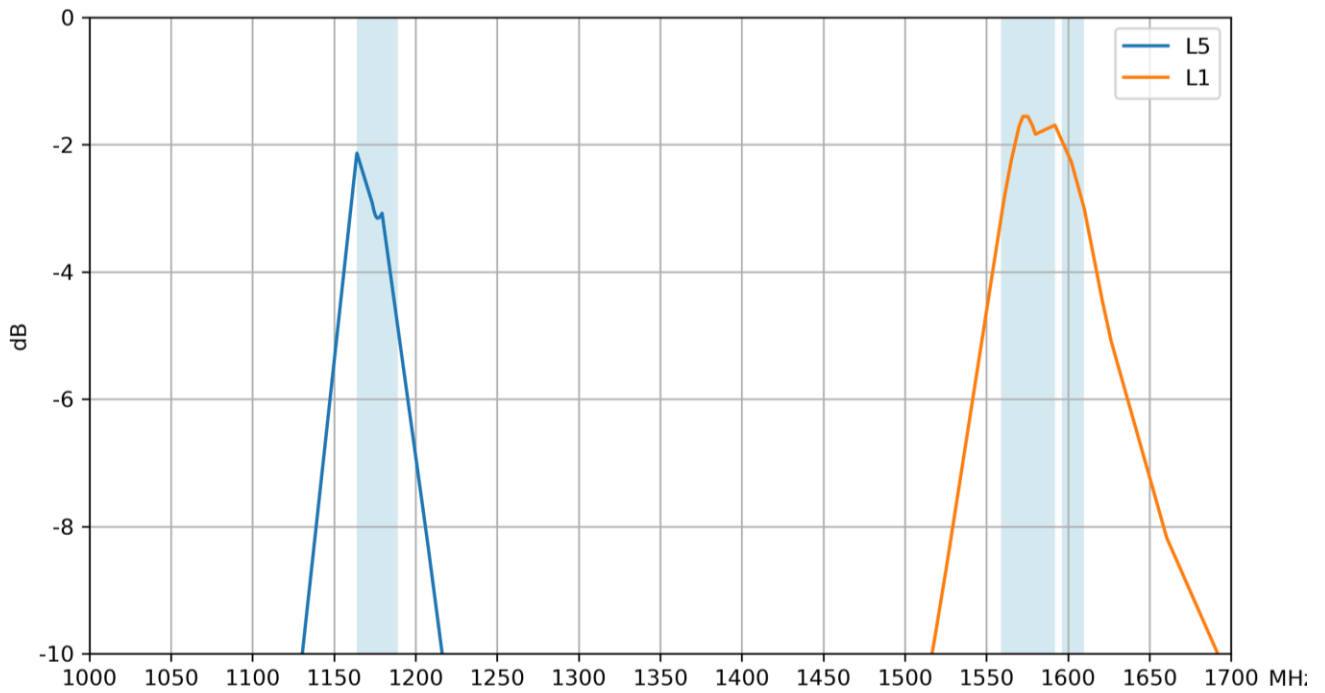

6.5 Peak Gain (GNSS)

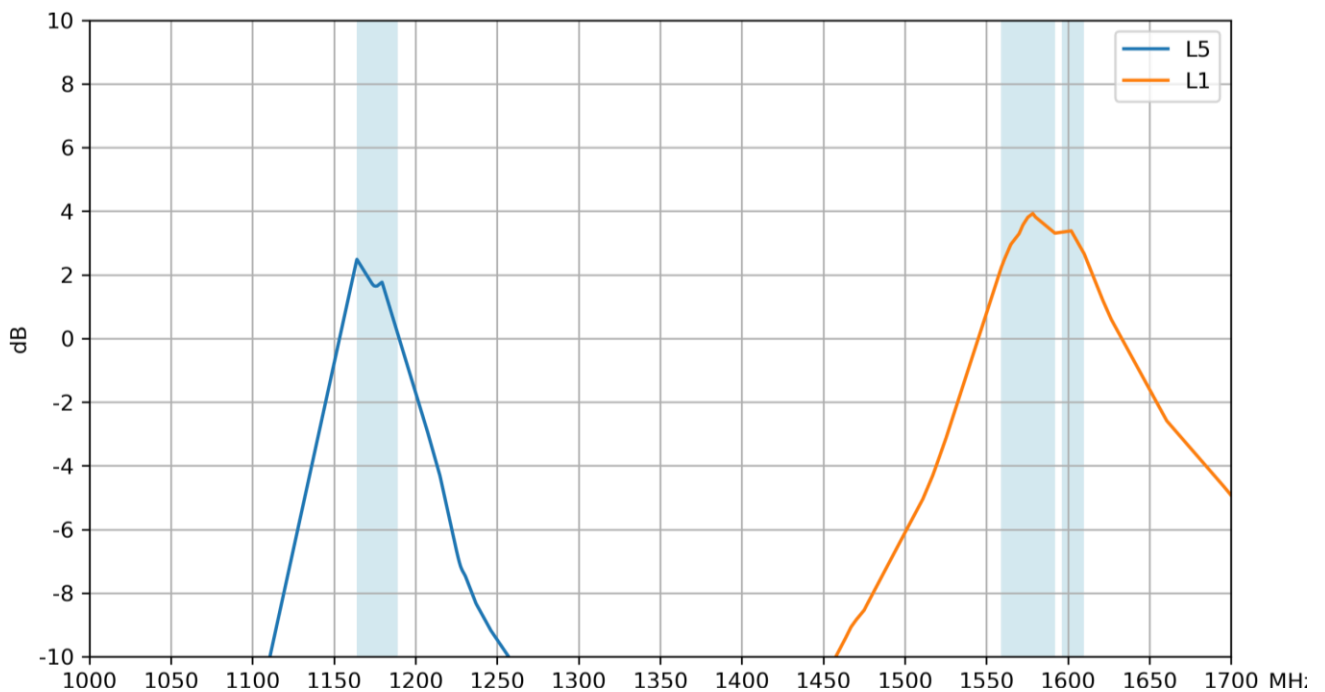

6.6 Return Loss (5G/4G)

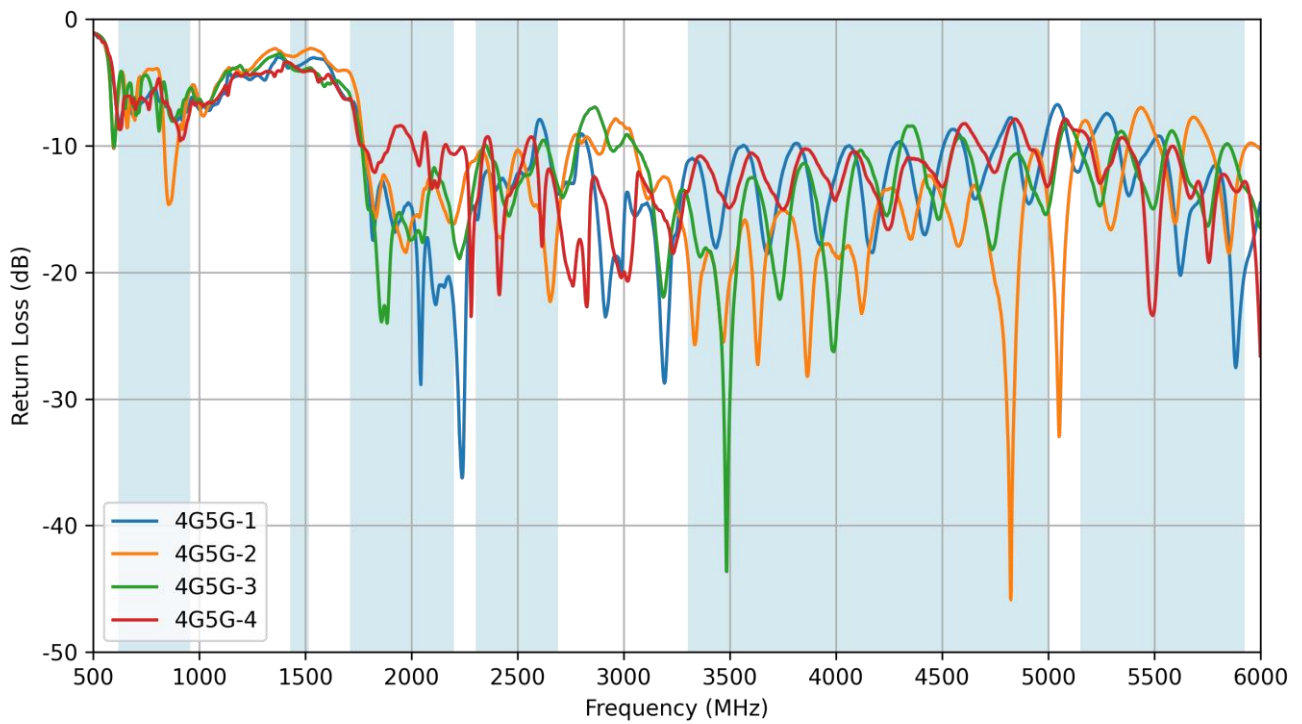

6.7 VSWR (5G/4G)

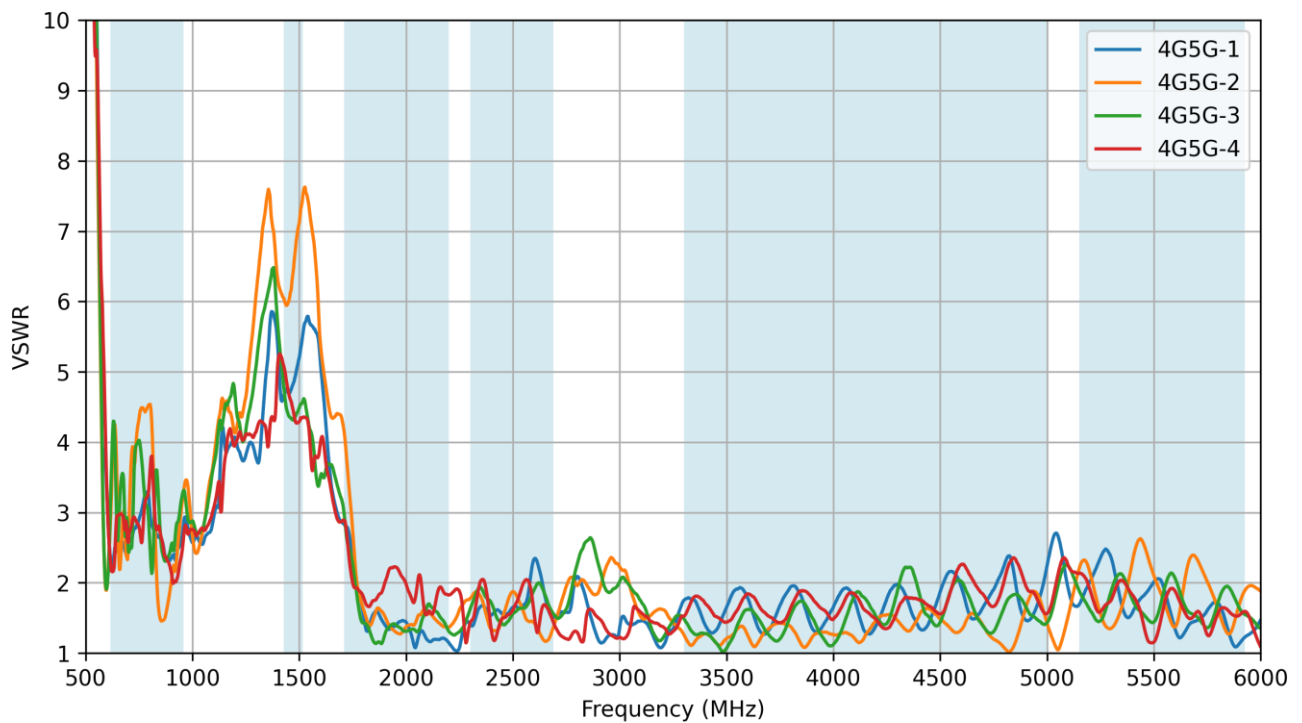

6.8 Isolation (5G/4G)

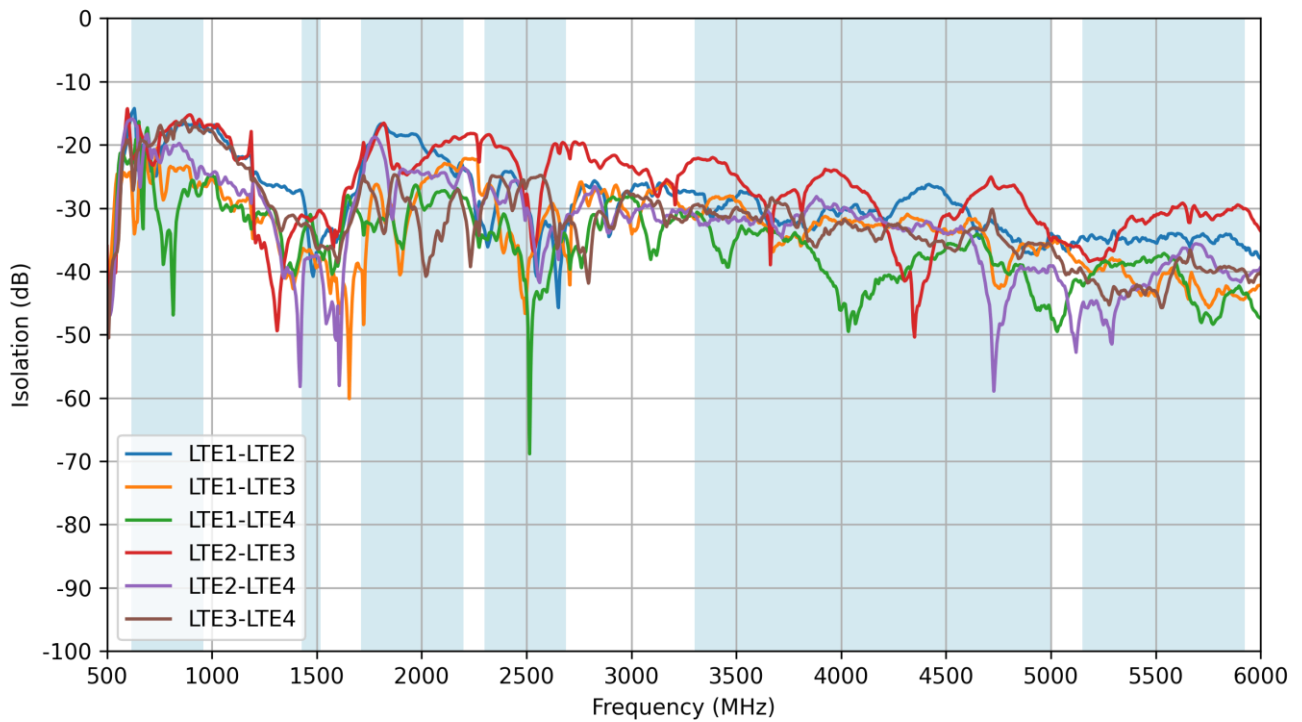

6.9 Efficiency (5G/4G)

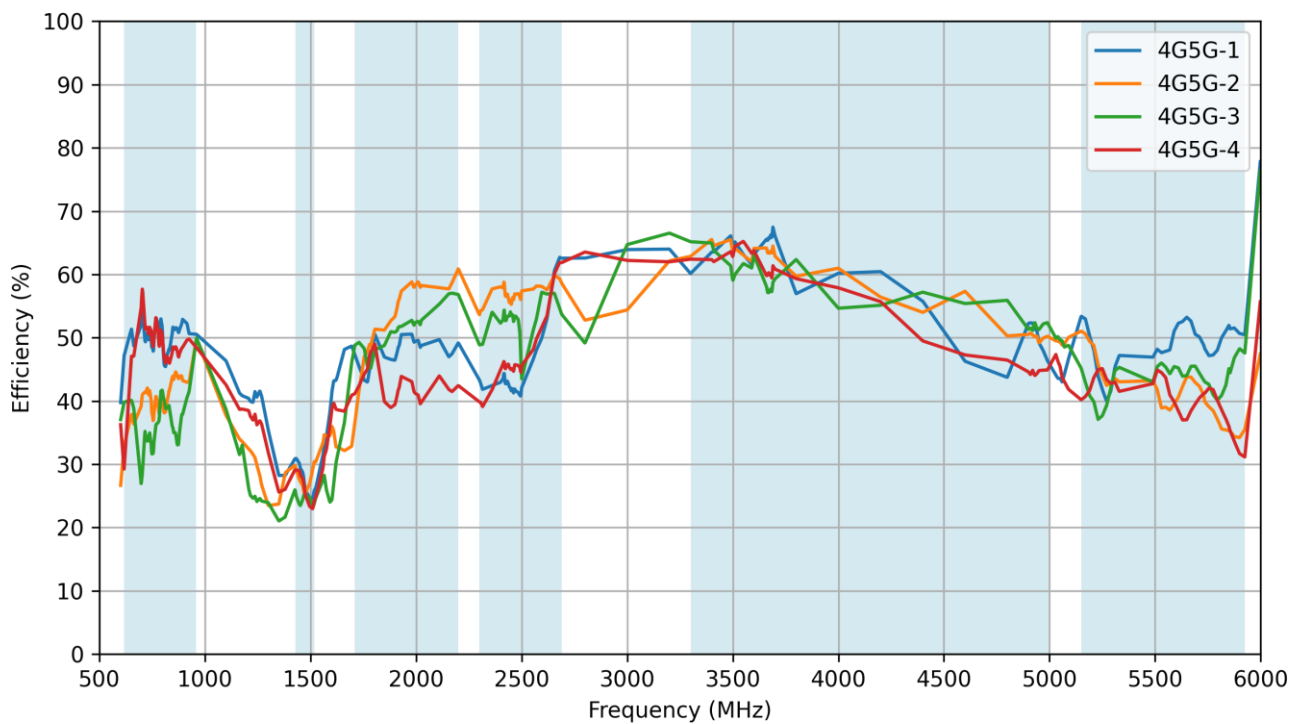

6.10 Average Gain (5G/4G)

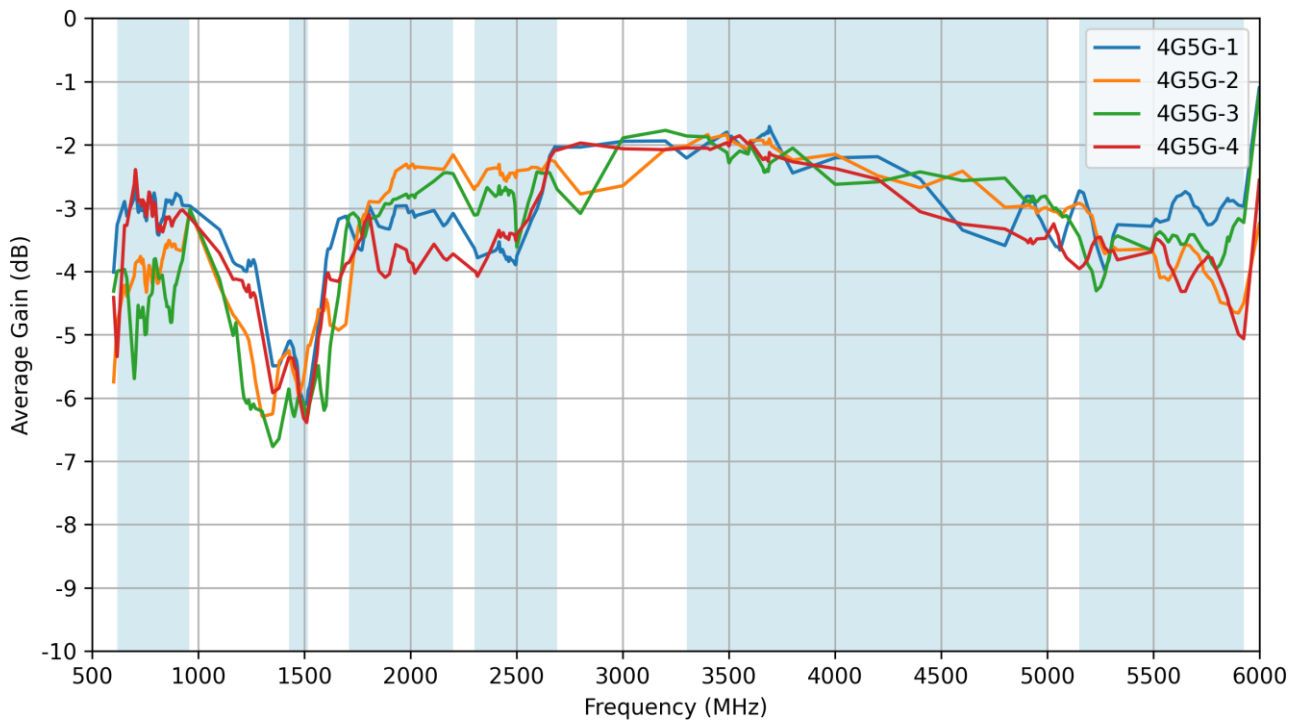

6.11 Peak Gain (5G/4G)

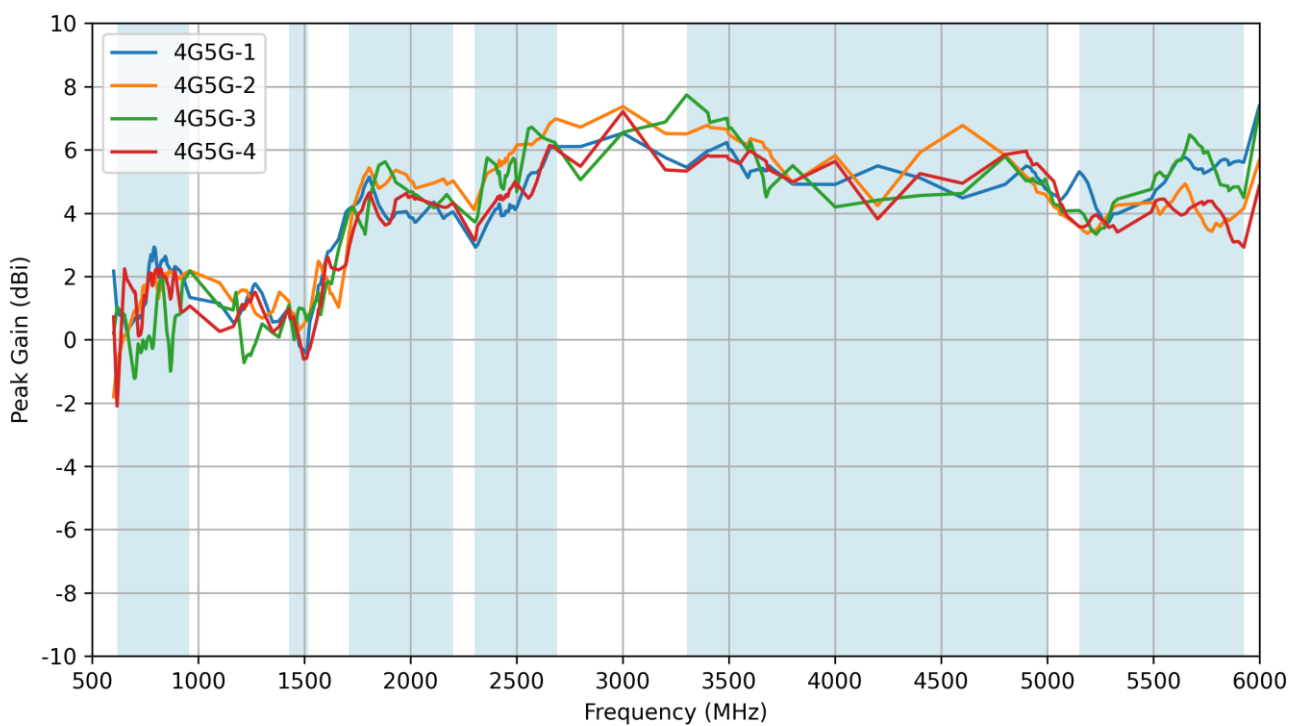

7. LNA Characteristics

7.1 Block Diagram

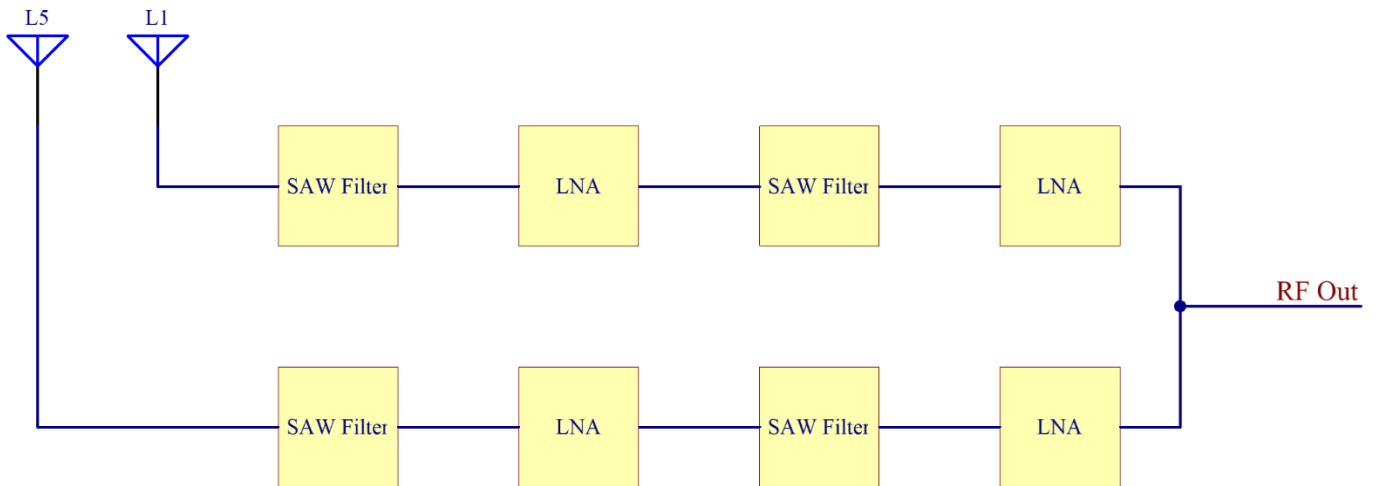

7.2 Gain – Low-Band

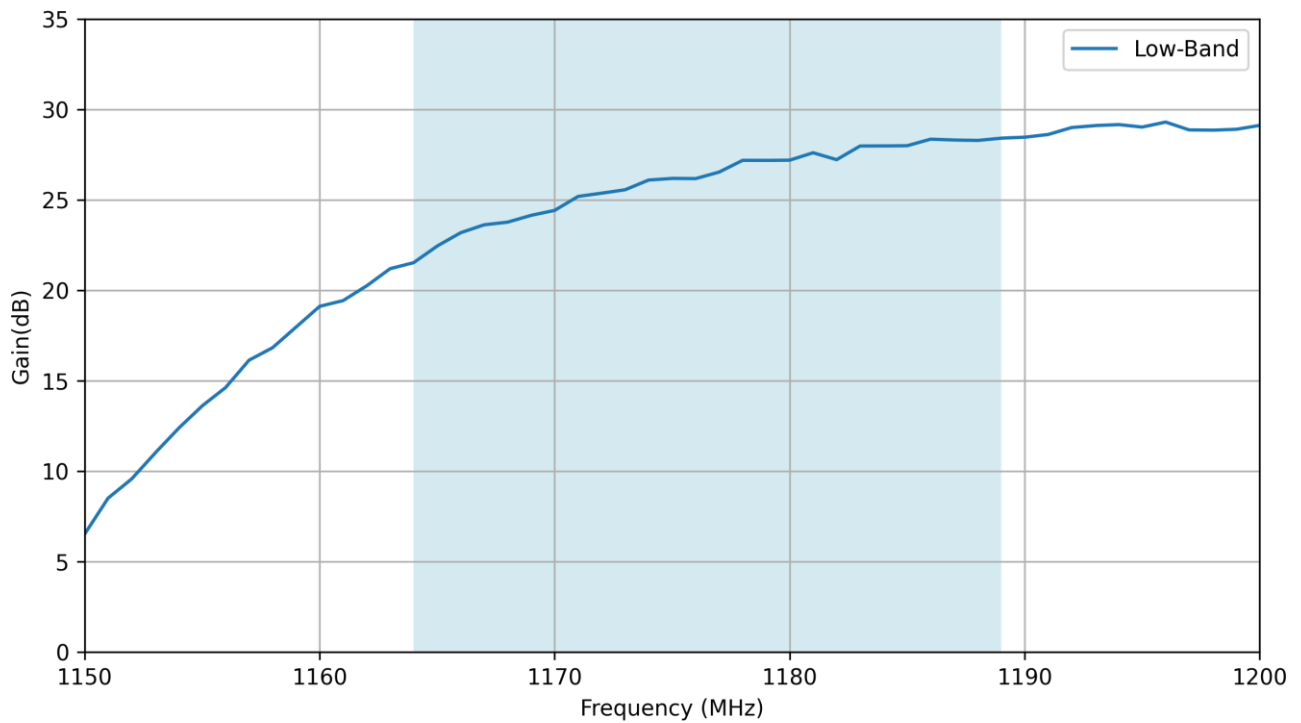

7.3 Gain – High-Band

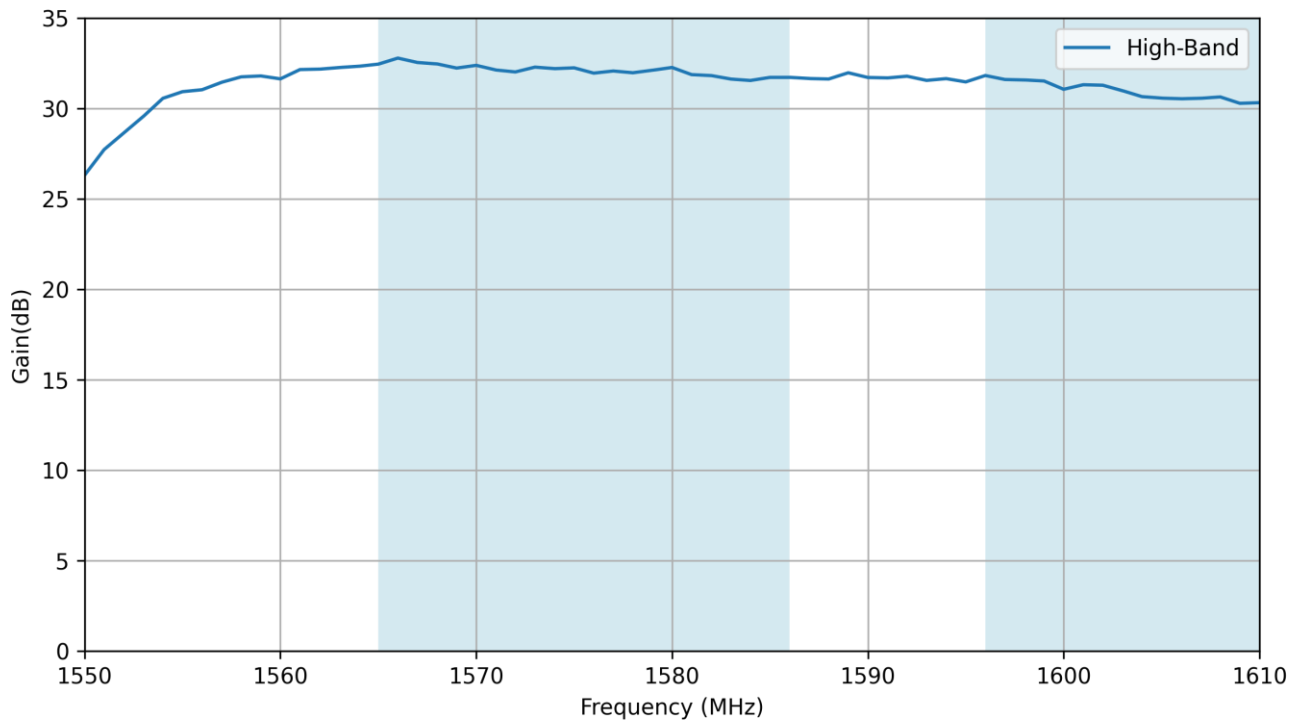

7.4 Out Of Band Attenuation

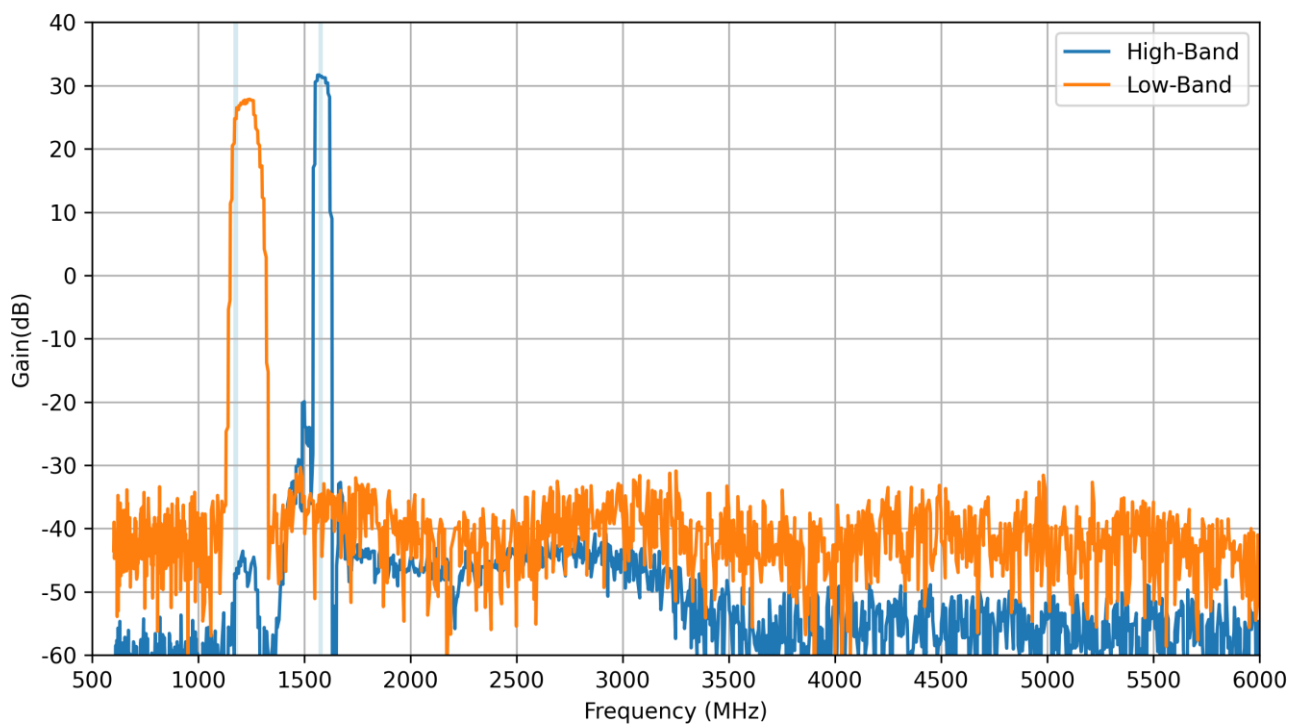

8. Radiation Patterns

8.1 Test Setup

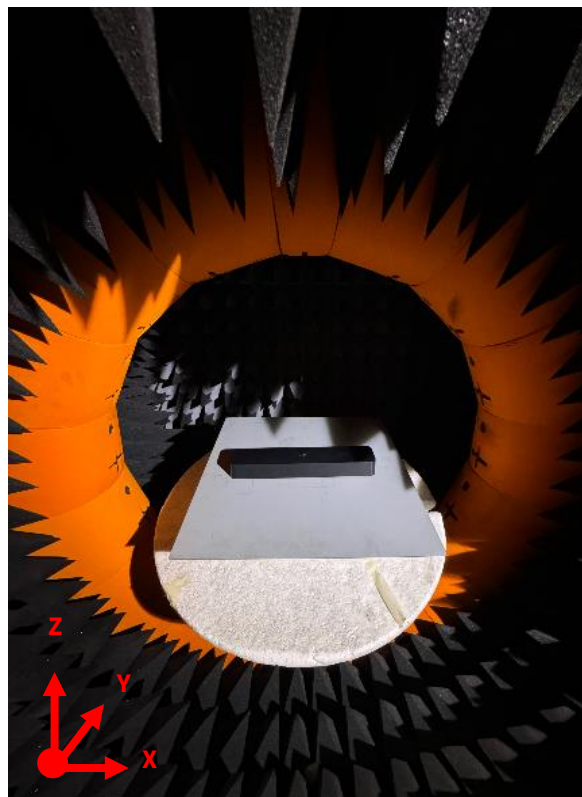
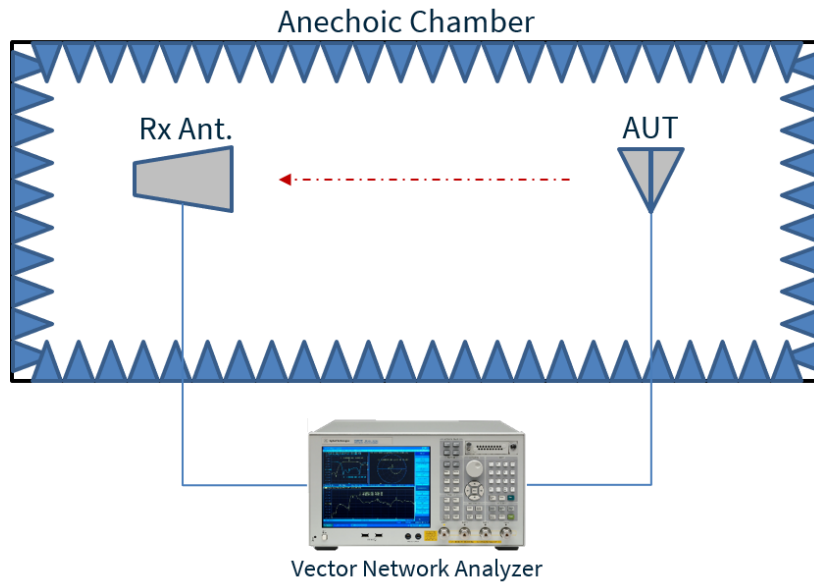

Chamber Test Set up

8.2 GNSS - Patterns at 1176 MHz

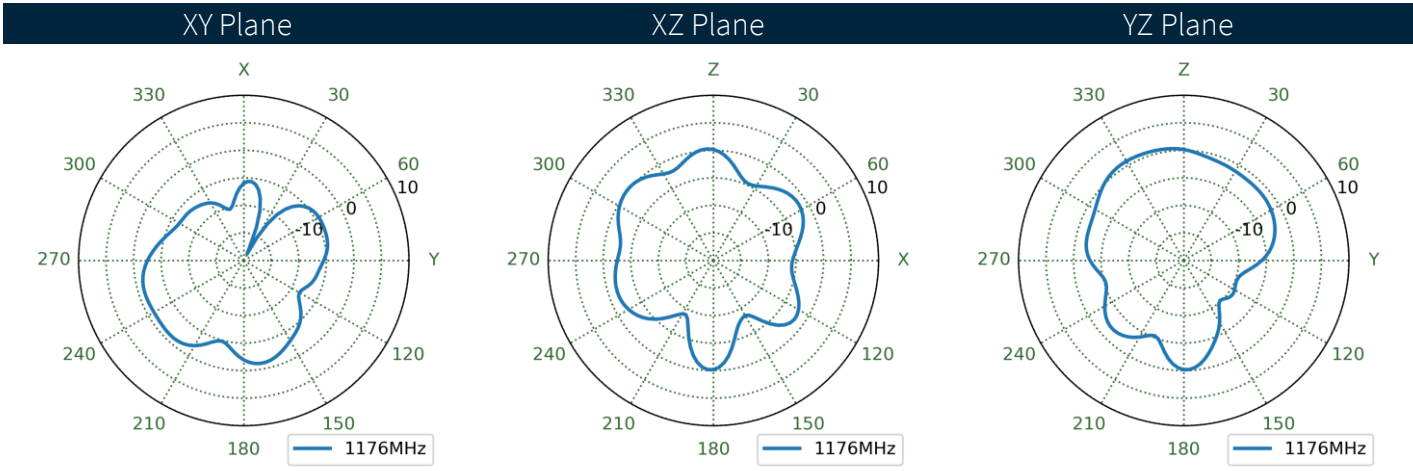
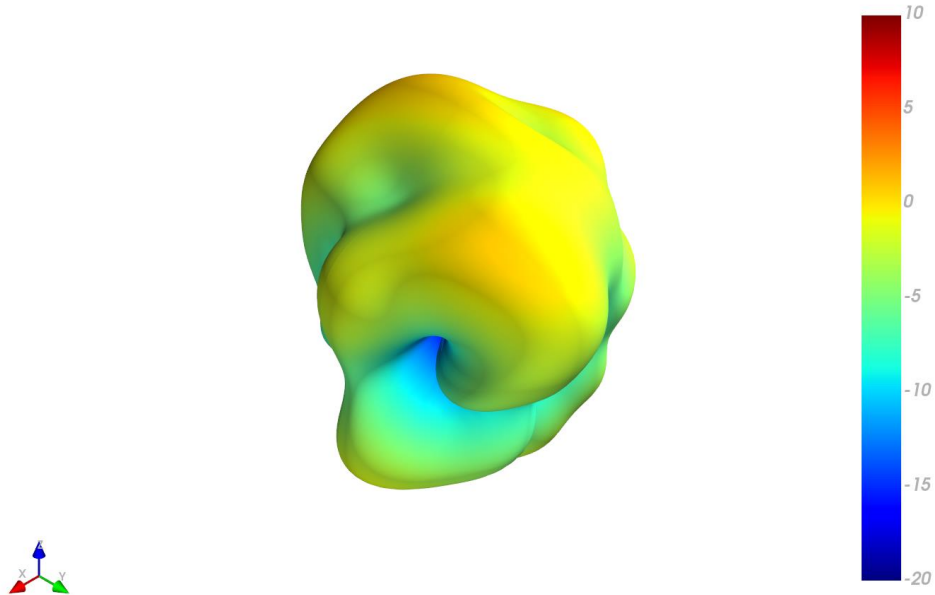

8.3 GNSS - Patterns at 1575 MHz

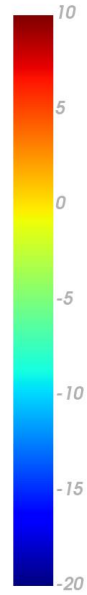
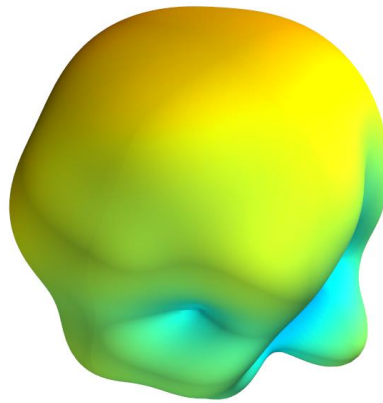

XY Plane XZ Plane YZ Plane

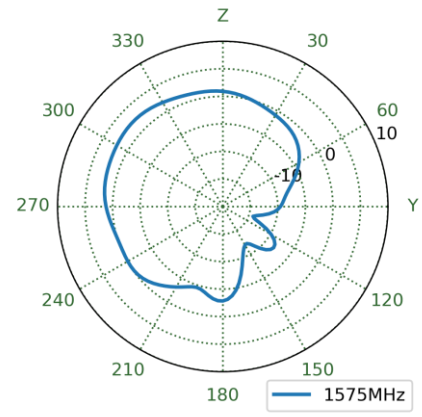
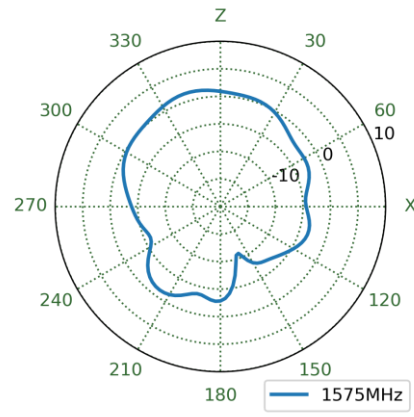
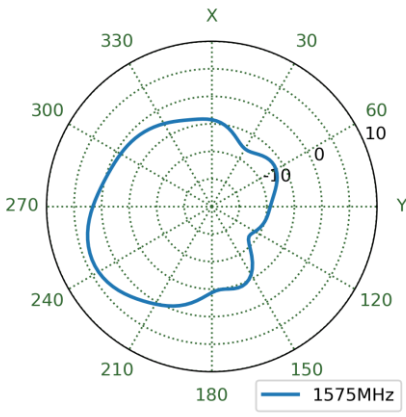

8.4 5G/4G-1 Patterns at 650 MHz

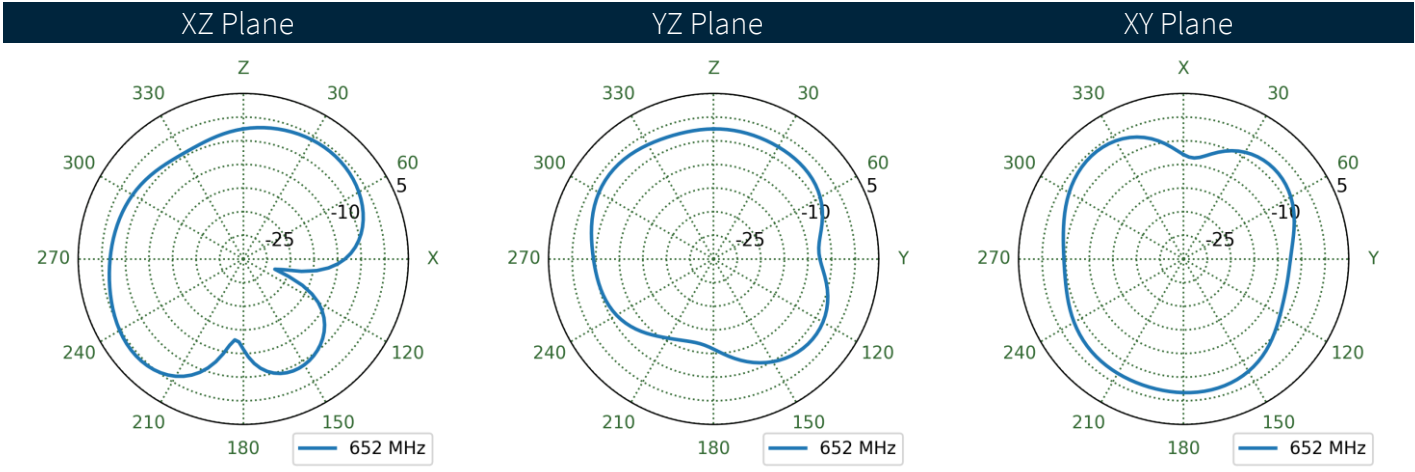
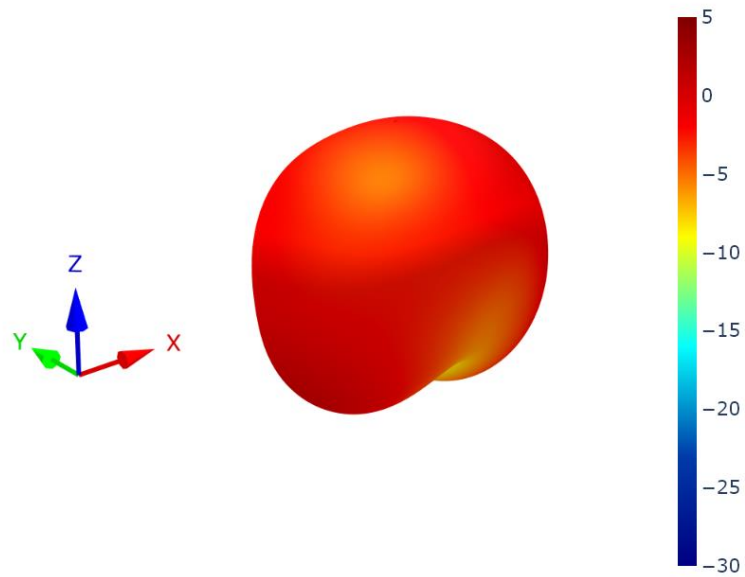

8.5 5G/4G-2 Patterns at 650 MHz

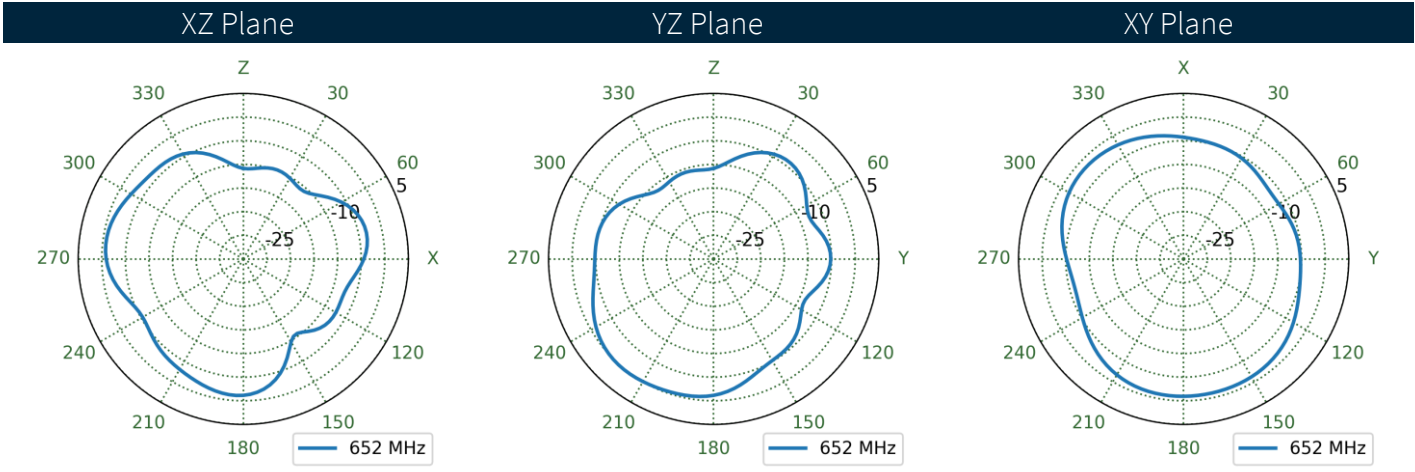
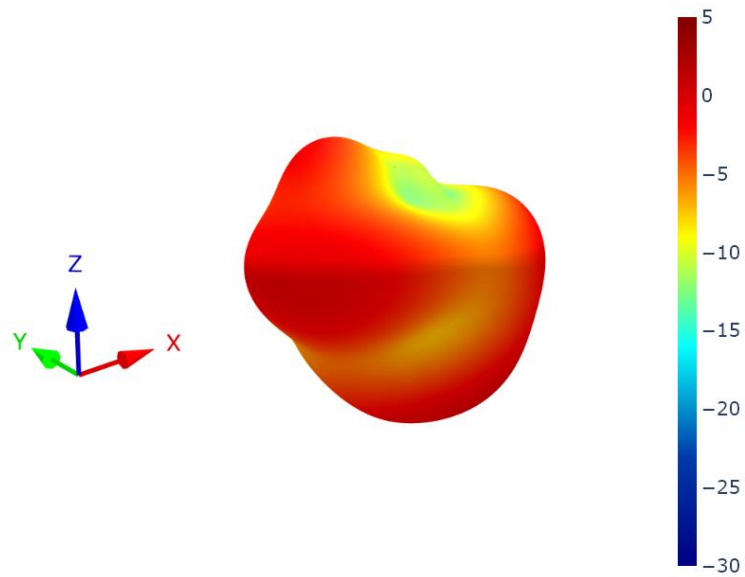

8.6 5G/4G-3 Patterns at 650 MHz

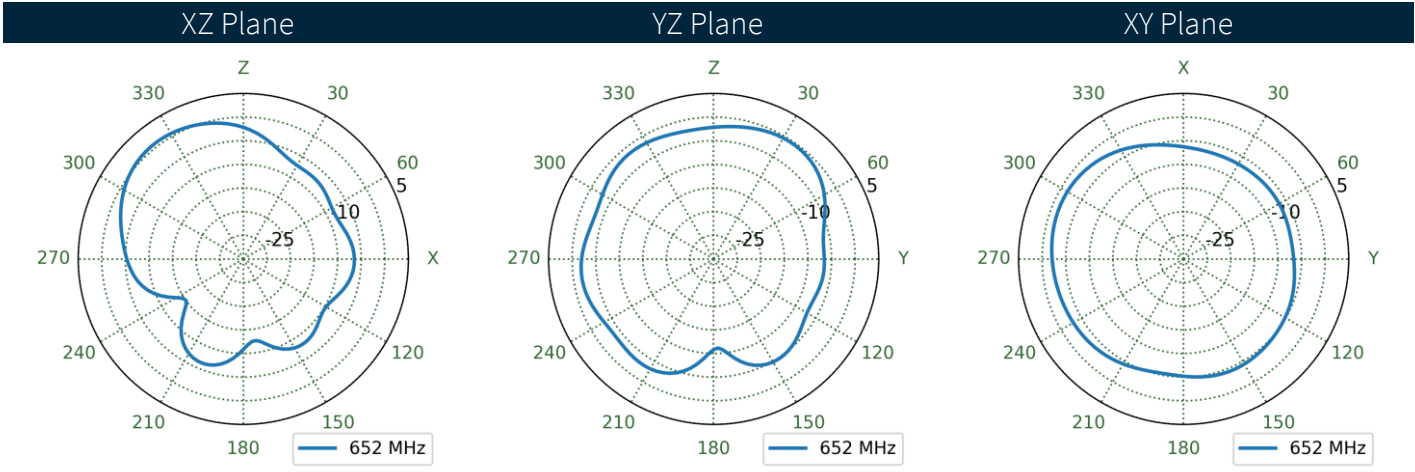
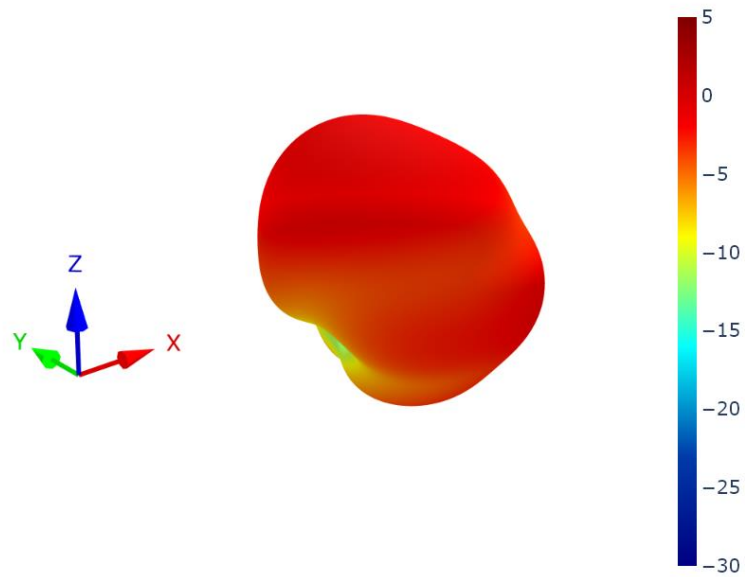

8.7 5G/4G-4 Patterns at 650 MHz

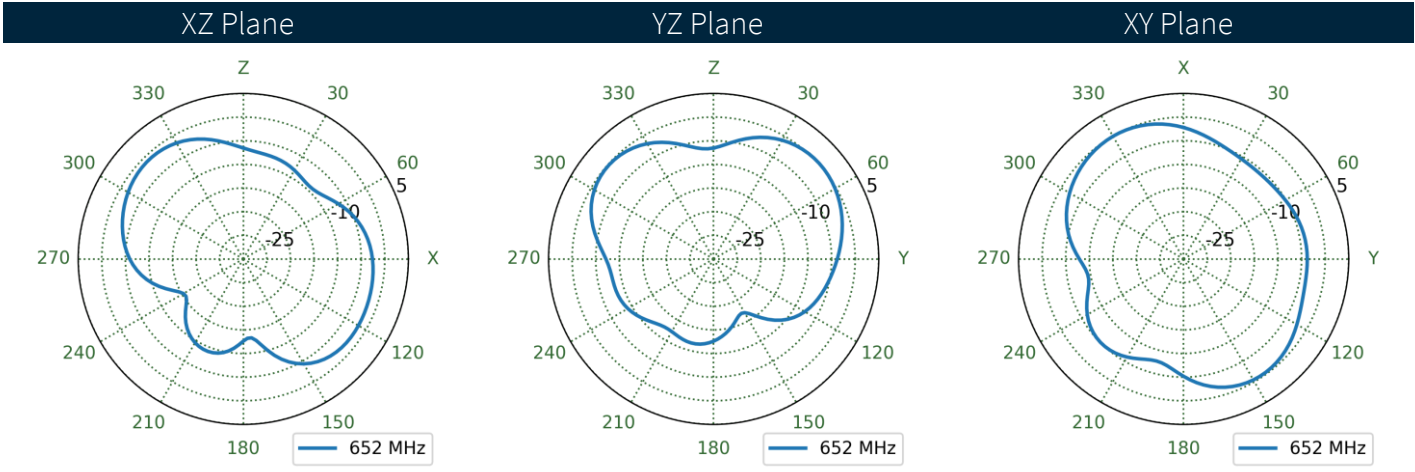
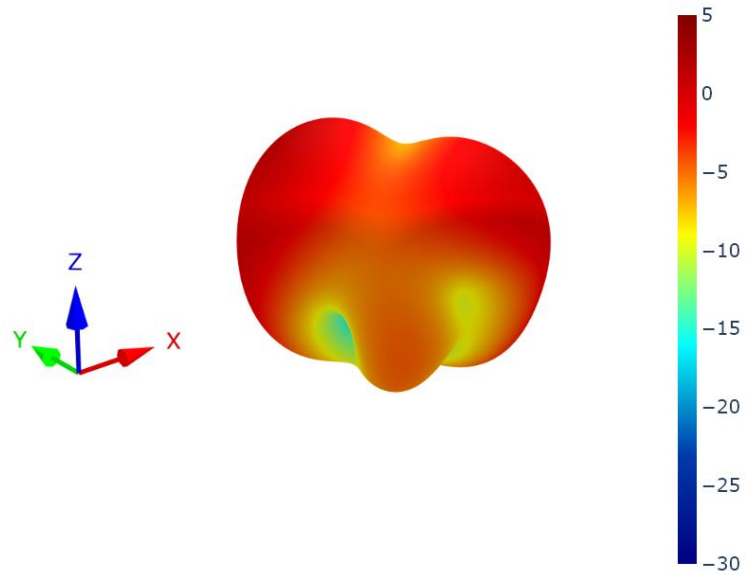

8.8 5G/4G-1 Patterns at 750 MHz

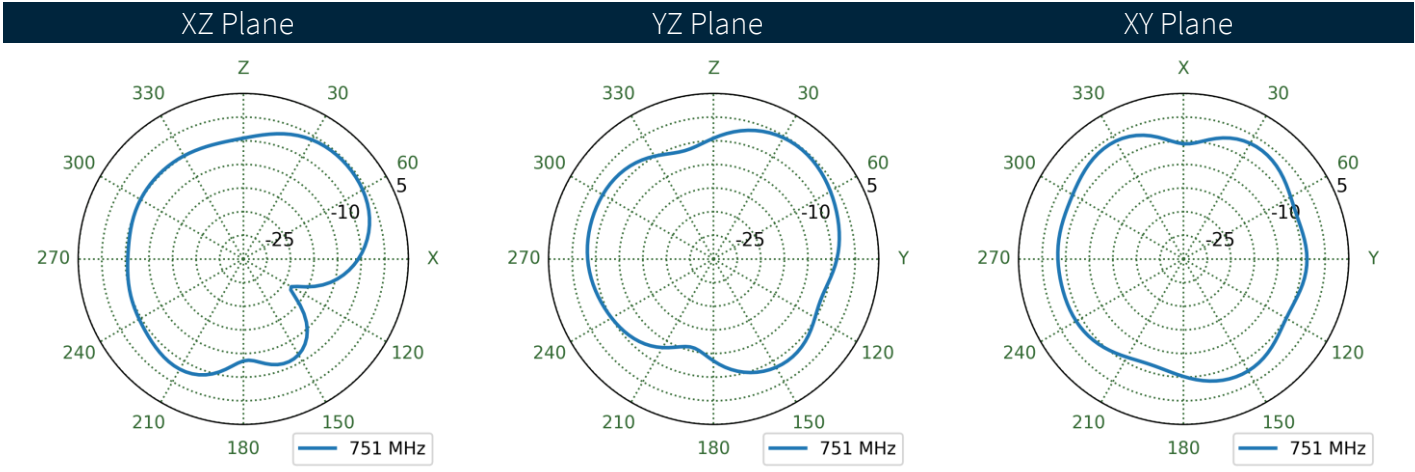
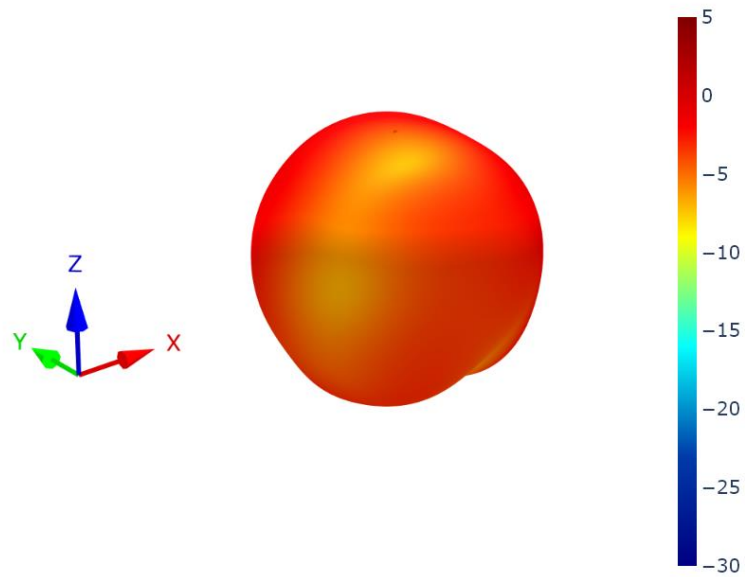

8.9 5G/4G-2 Patterns at 750 MHz

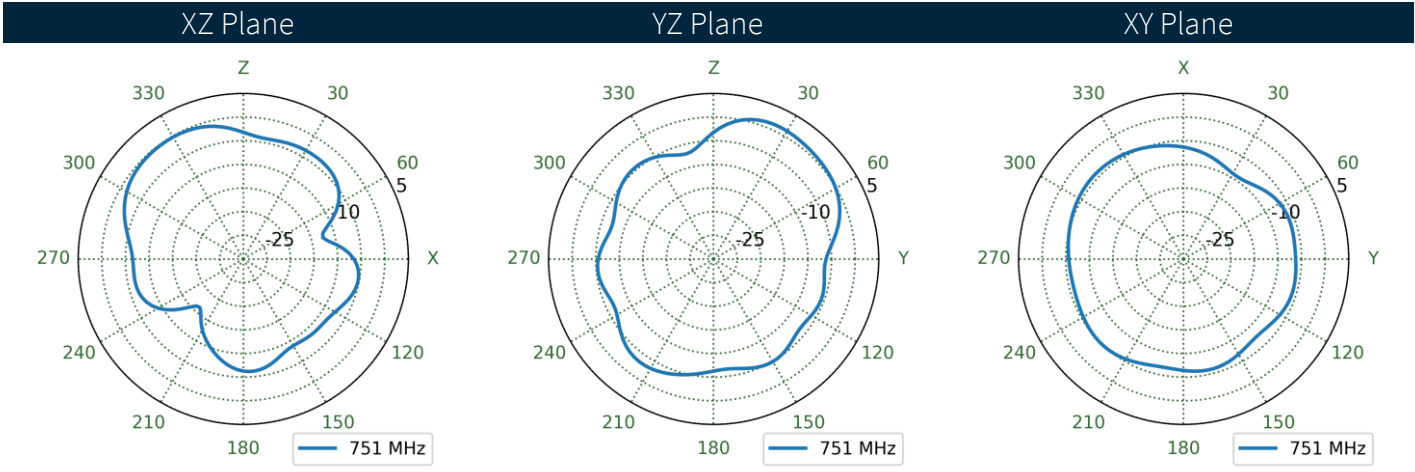
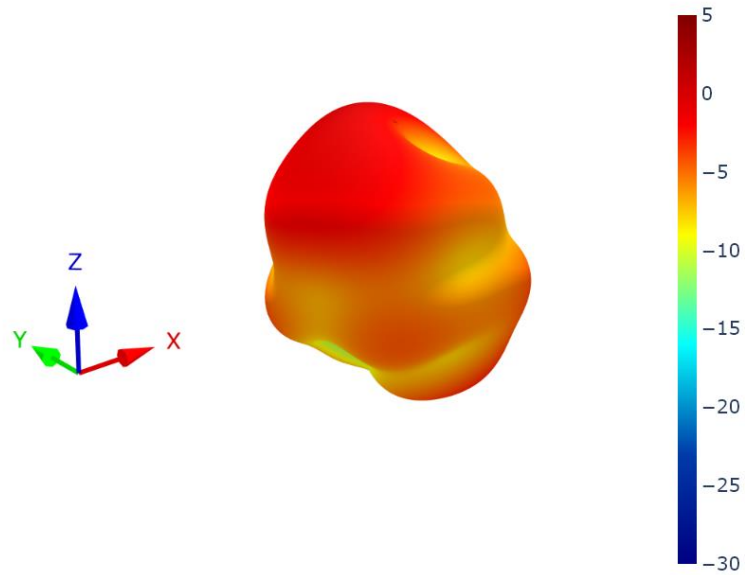

8.10 5G/4G-3 Patterns at 750 MHz

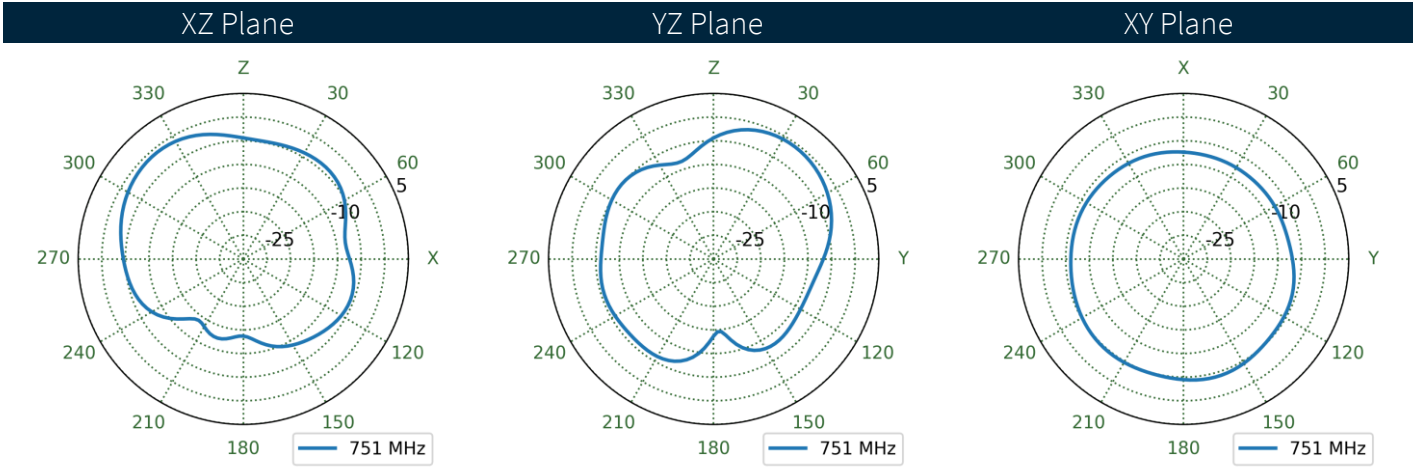
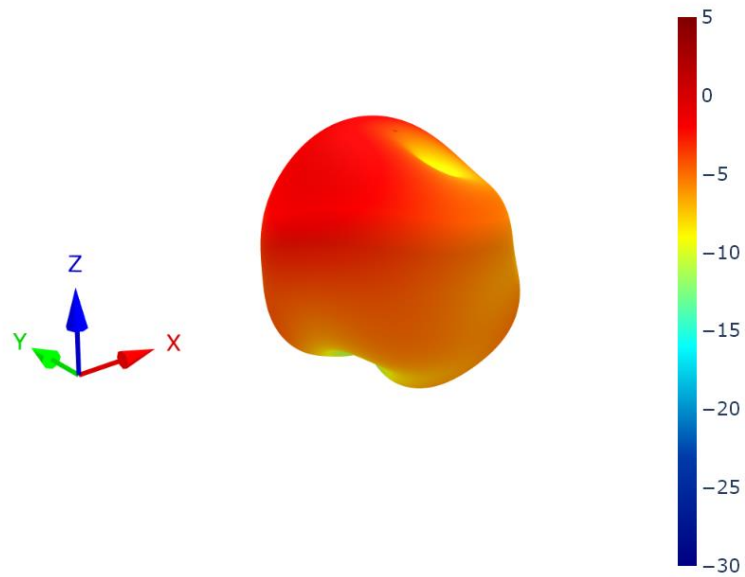

8.11 5G/4G-4 Patterns at 750 MHz

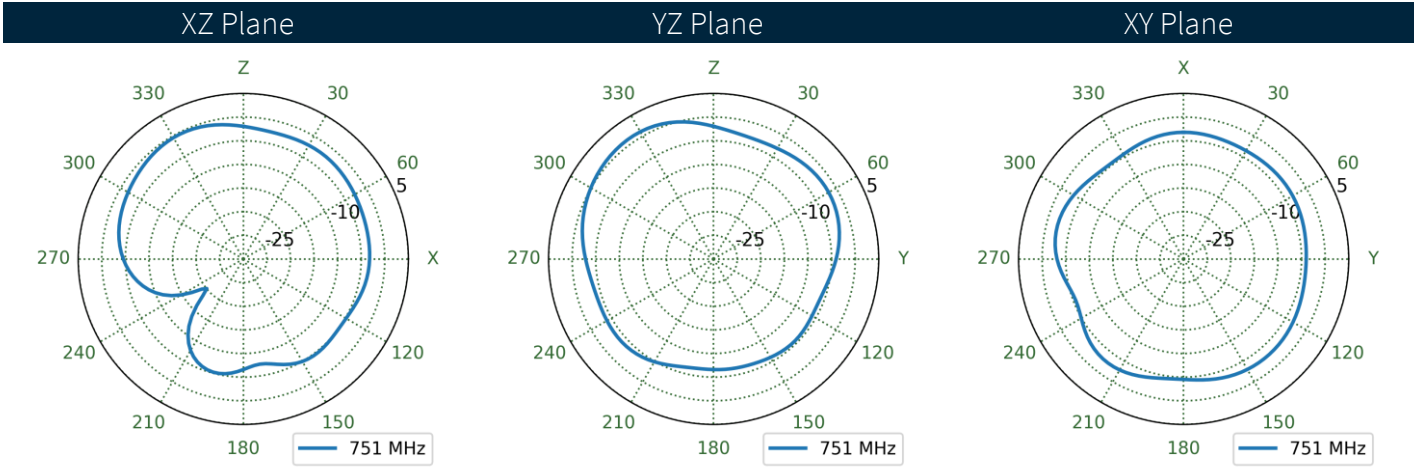
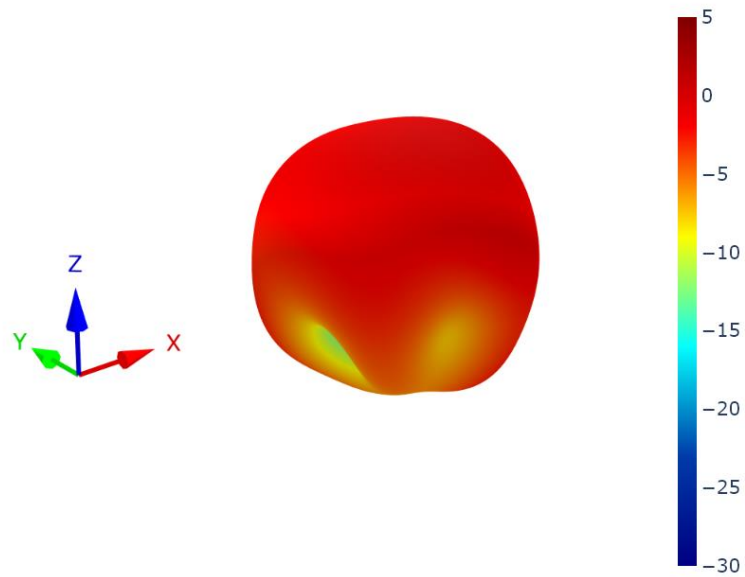

8.12 5G/4G-1 Patterns at 890 MHz

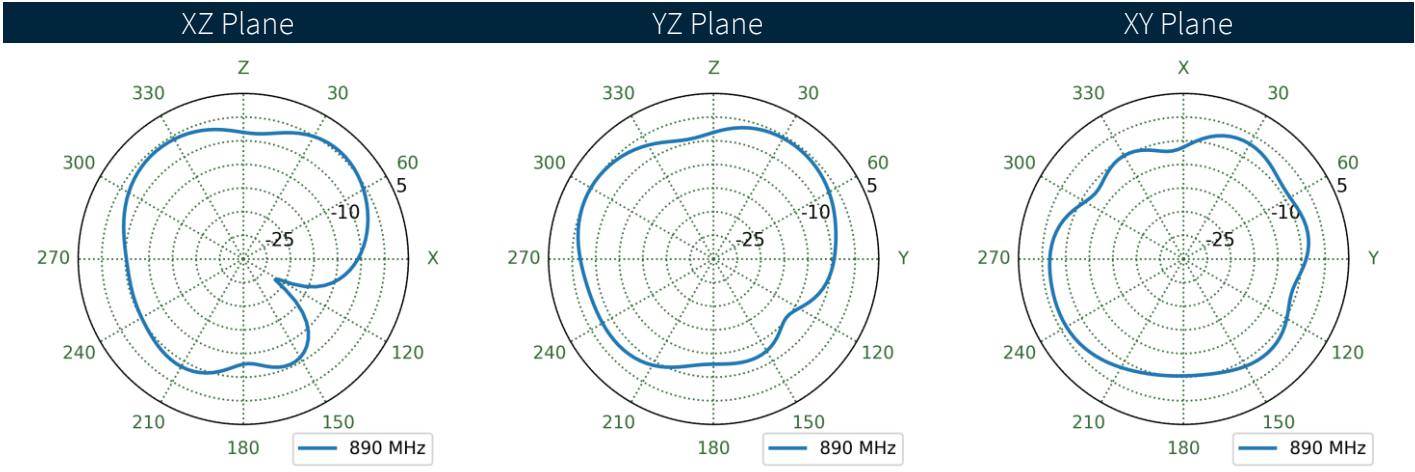
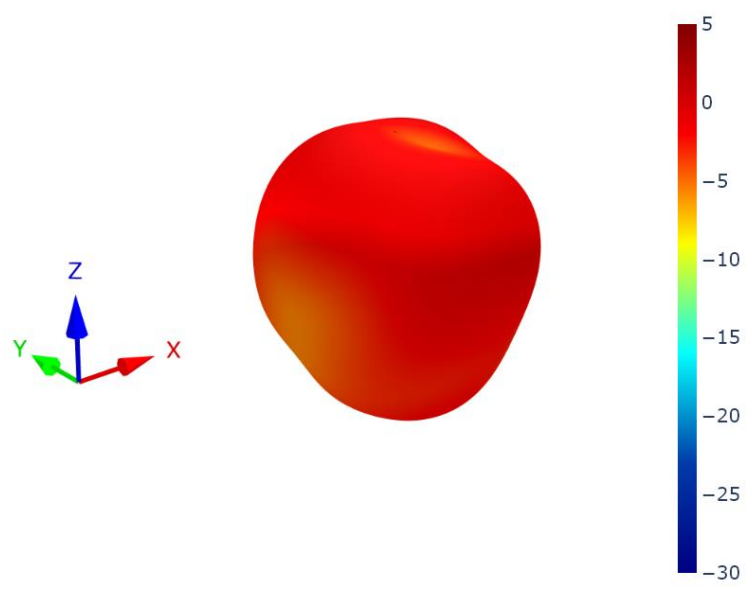

8.13 5G/4G-2 Patterns at 890 MHz

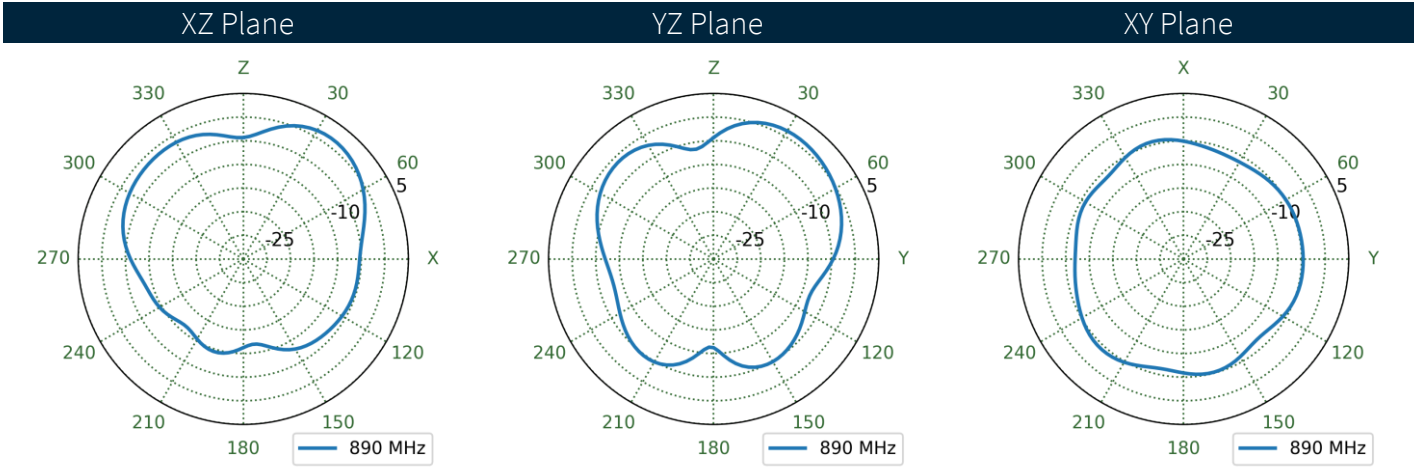
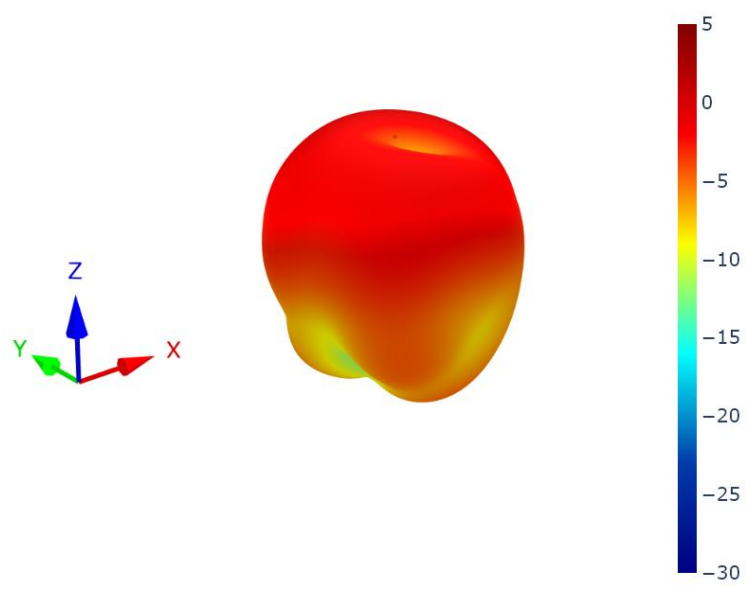

8.14 5G/4G-3 Patterns at 890 MHz

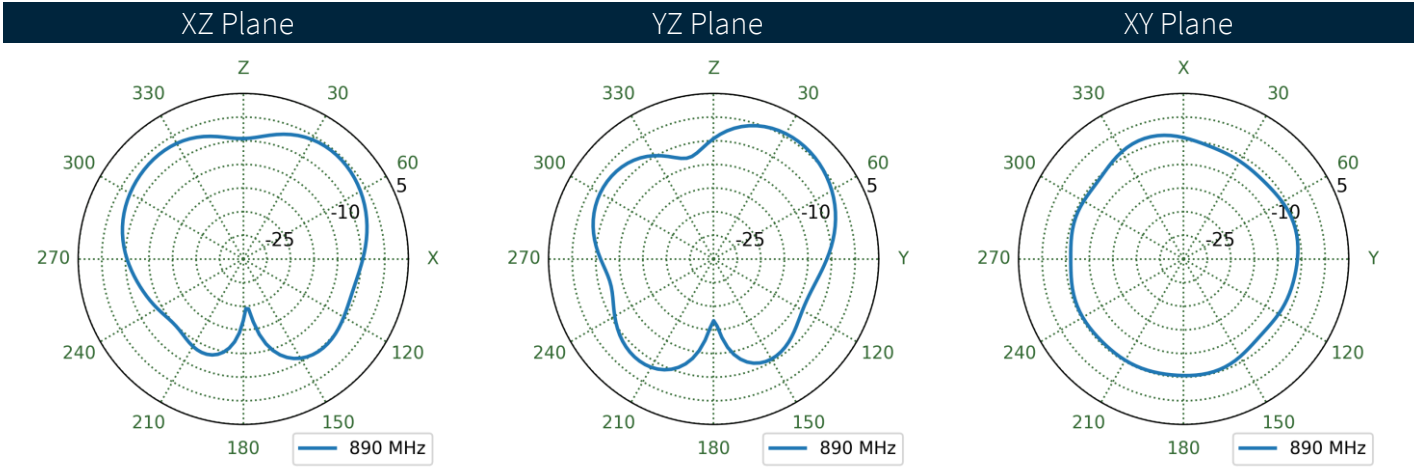
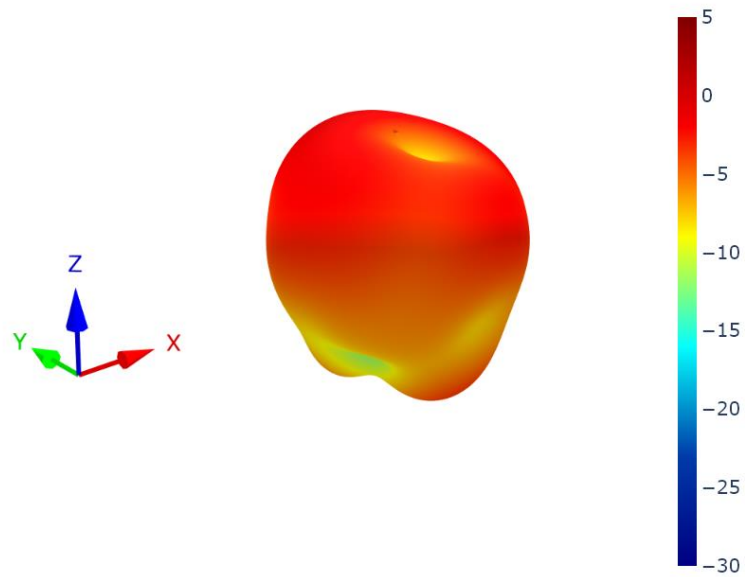

8.15 5G/4G-4 Patterns at 890 MHz

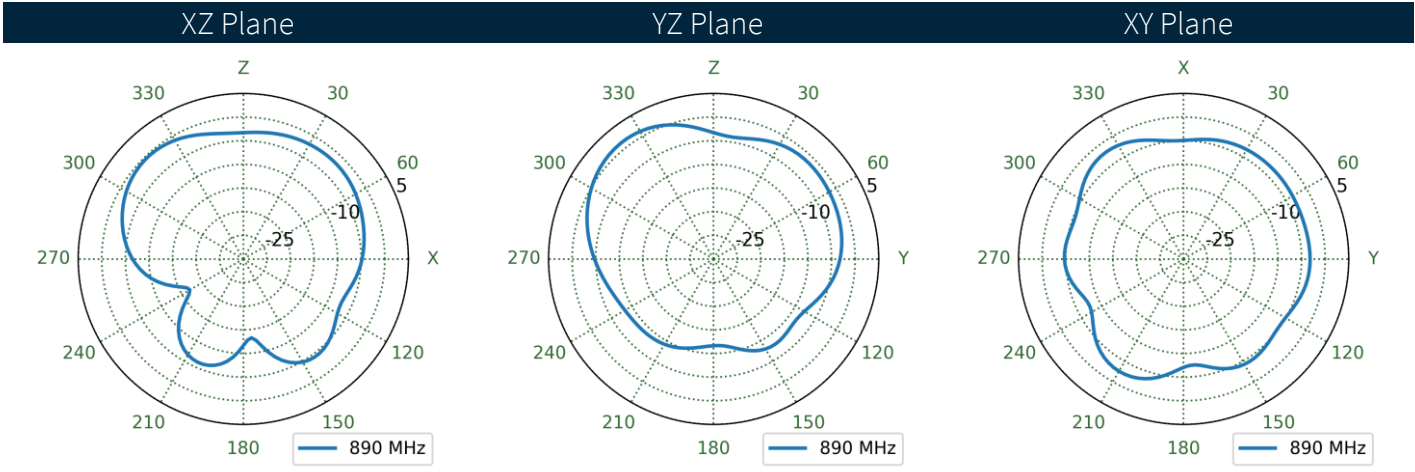
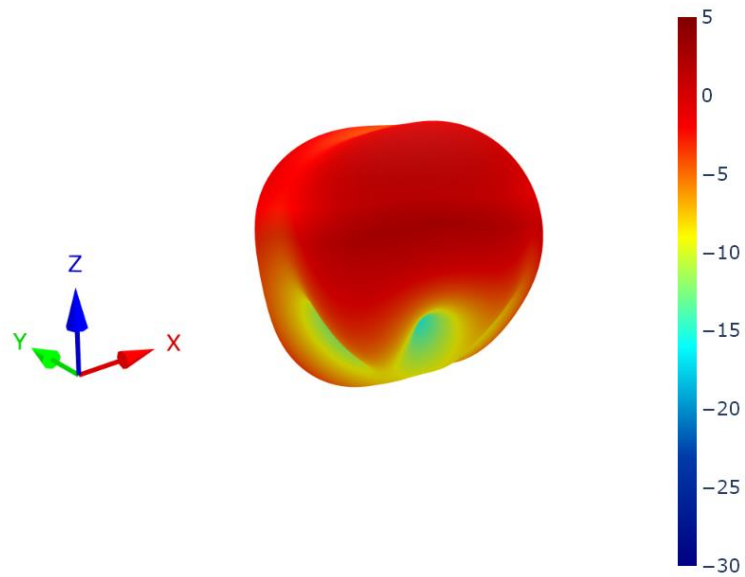

8.16 5G/4G-1 Patterns at 1470 MHz

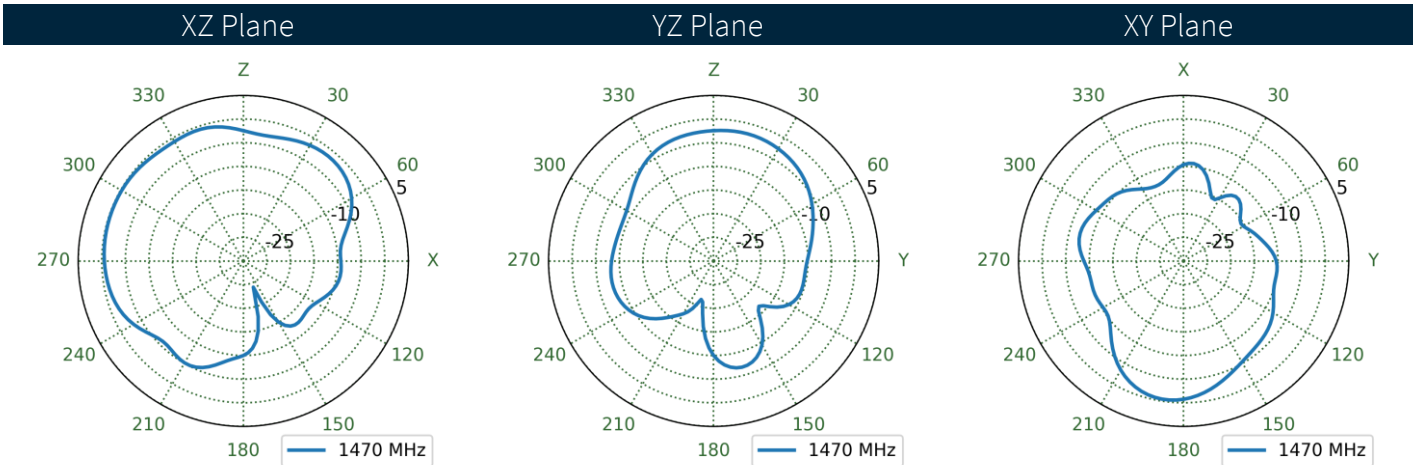
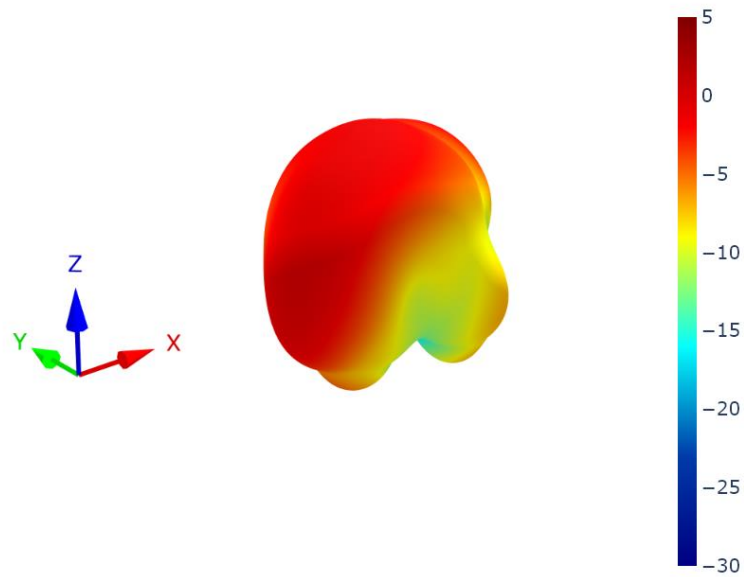

8.17 5G/4G-2 Patterns at 1470 MHz

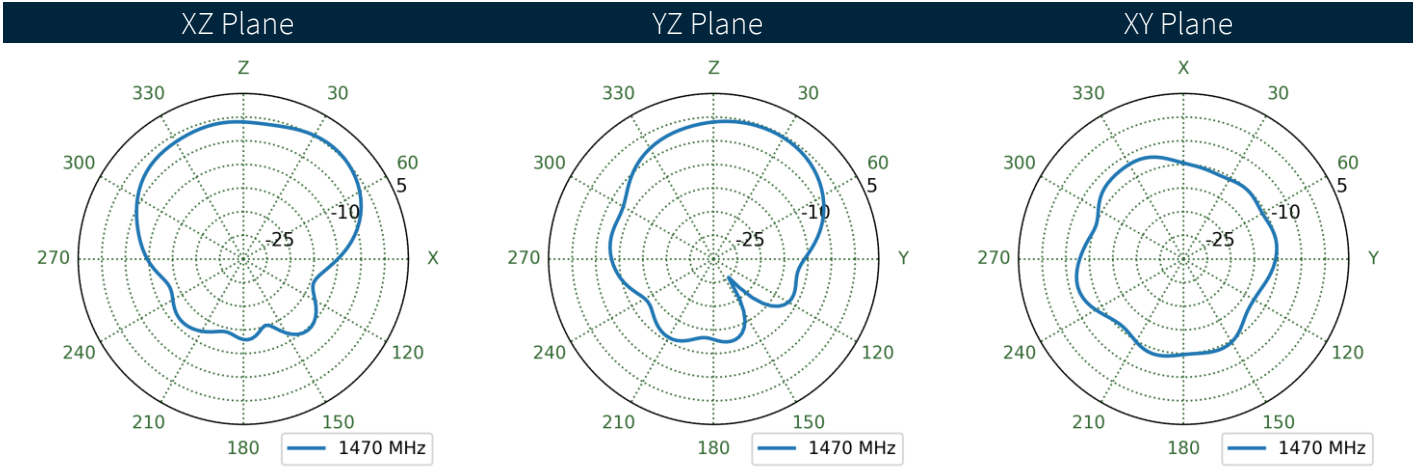
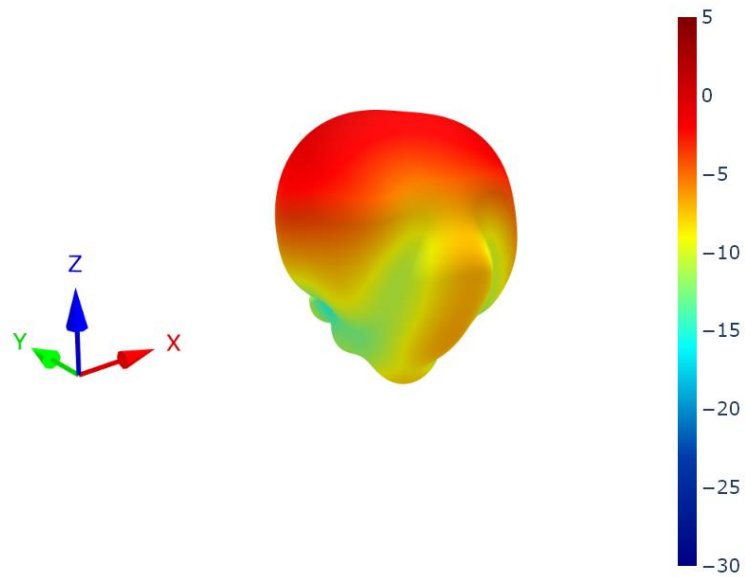

8.18 5G/4G-3 Patterns at 1470 MHz

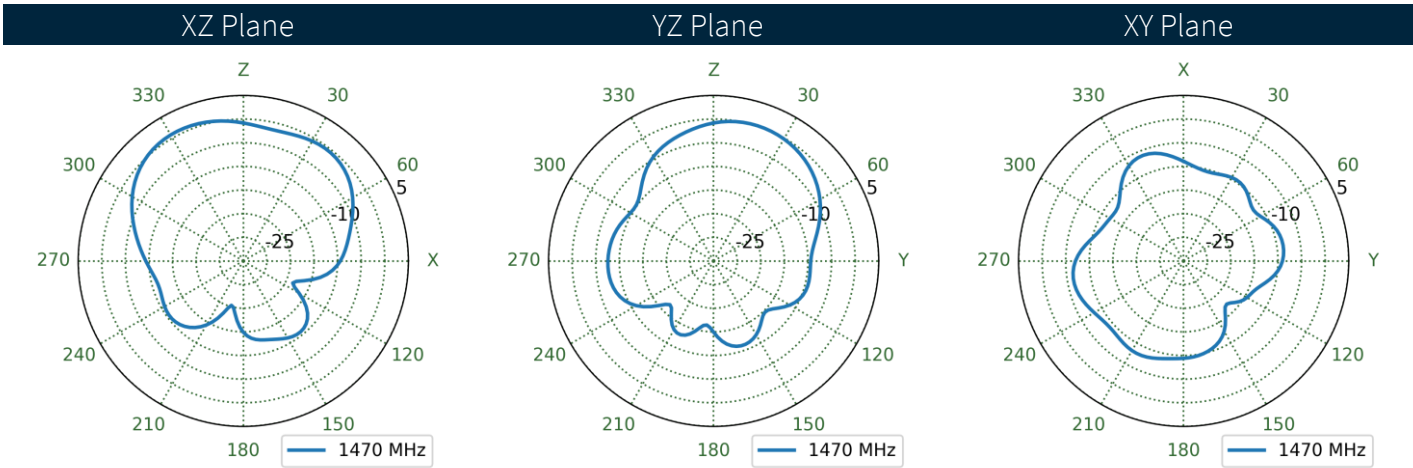
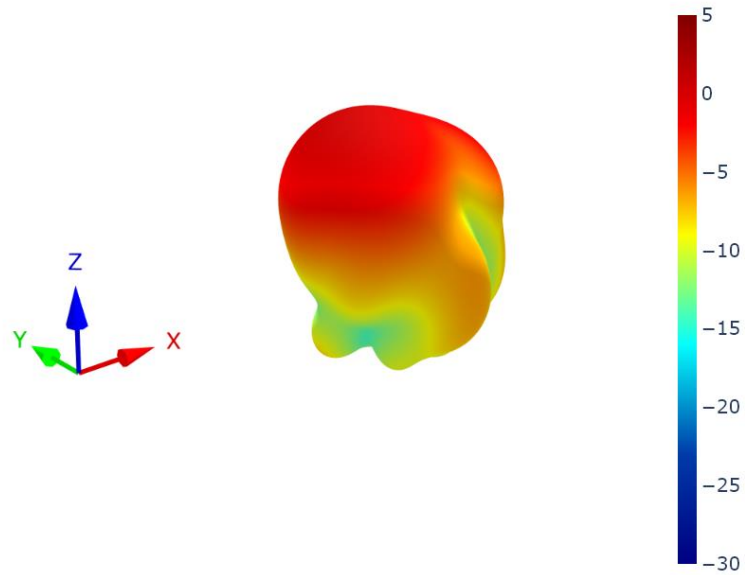

8.19 5G/4G-4 Patterns at 1470 MHz

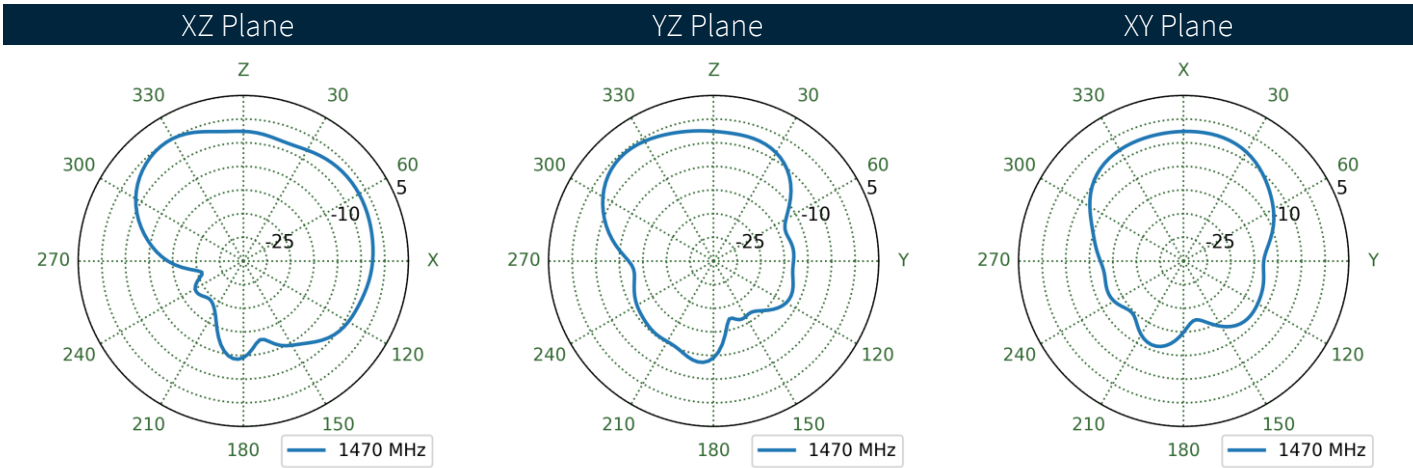
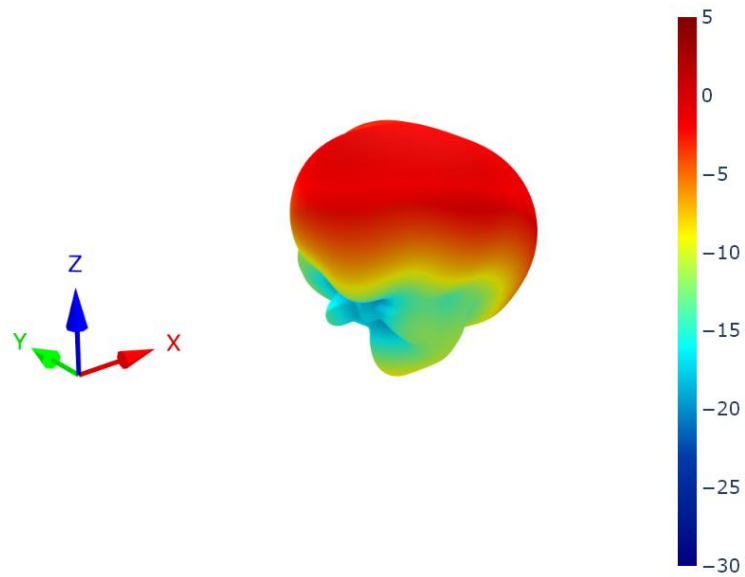

8.20 5G/4G-1 Patterns at 1805 MHz

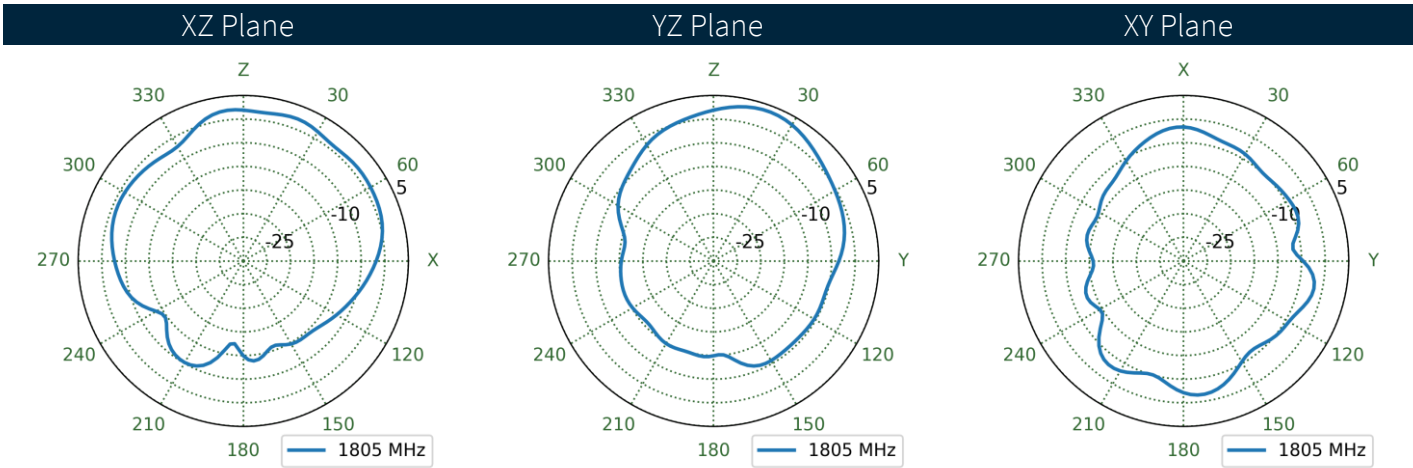
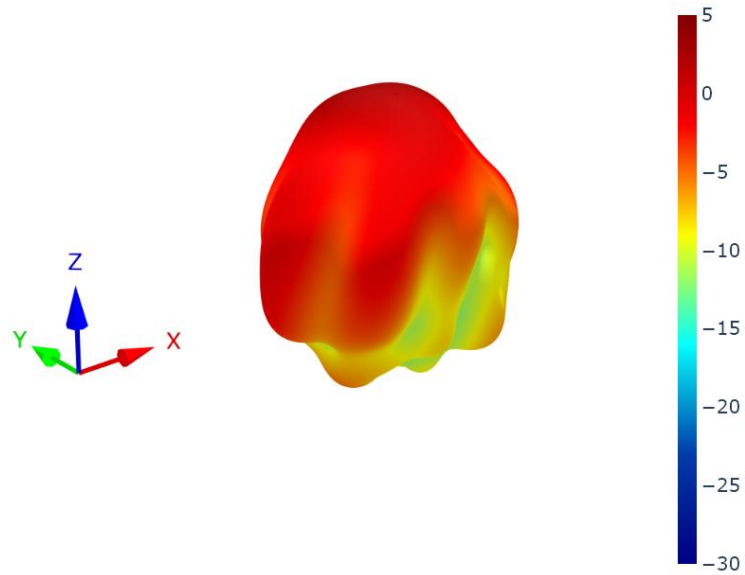

8.21 5G/4G-2 Patterns at 1805 MHz

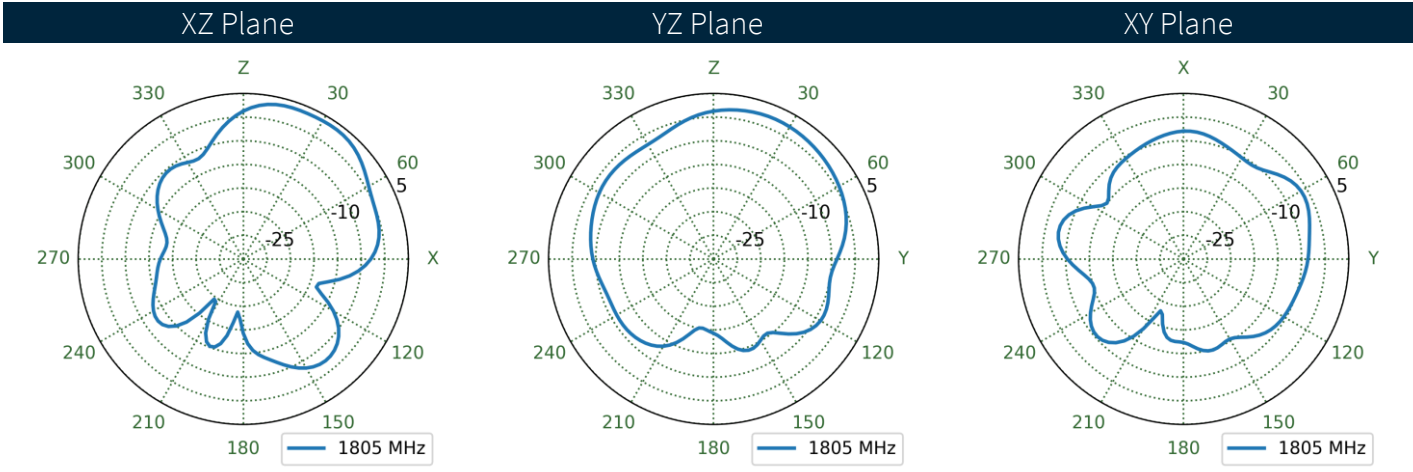
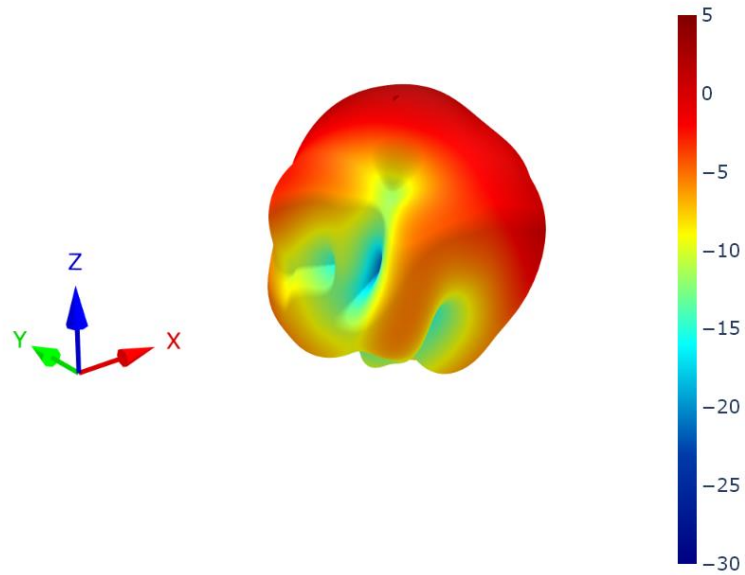

8.22 5G/4G-3 Patterns at 1805 MHz

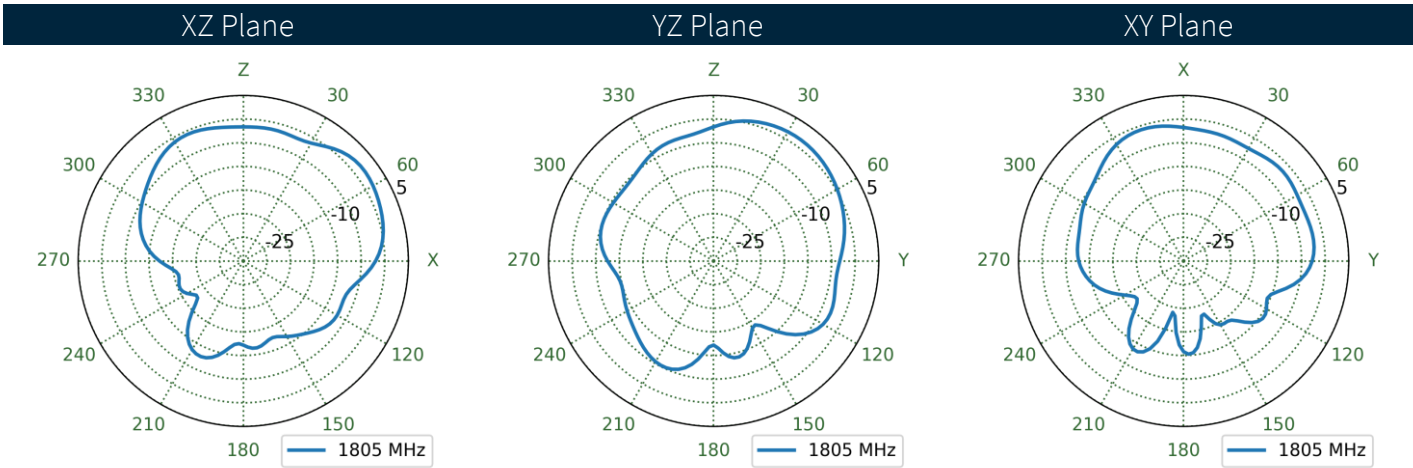
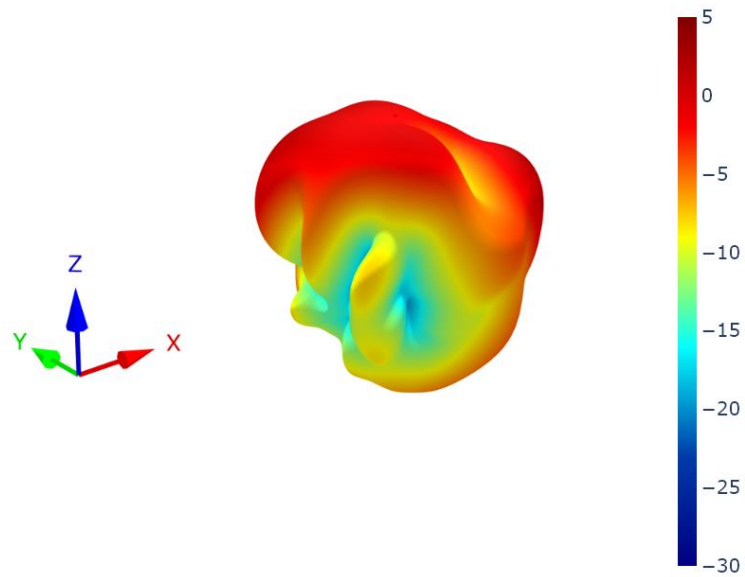

8.23 5G/4G-4 Patterns at 1805 MHz

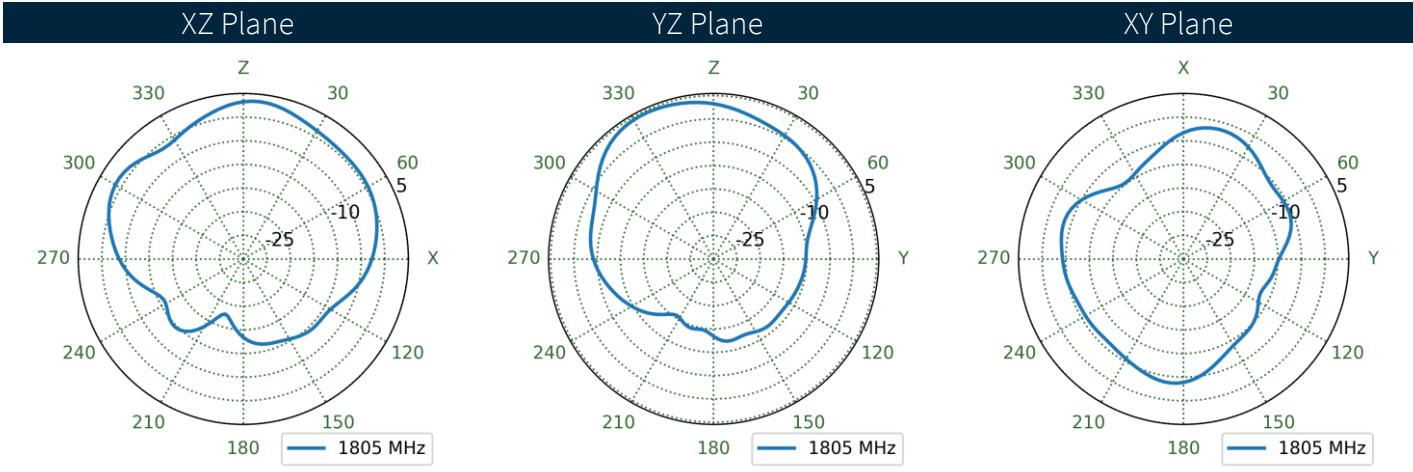
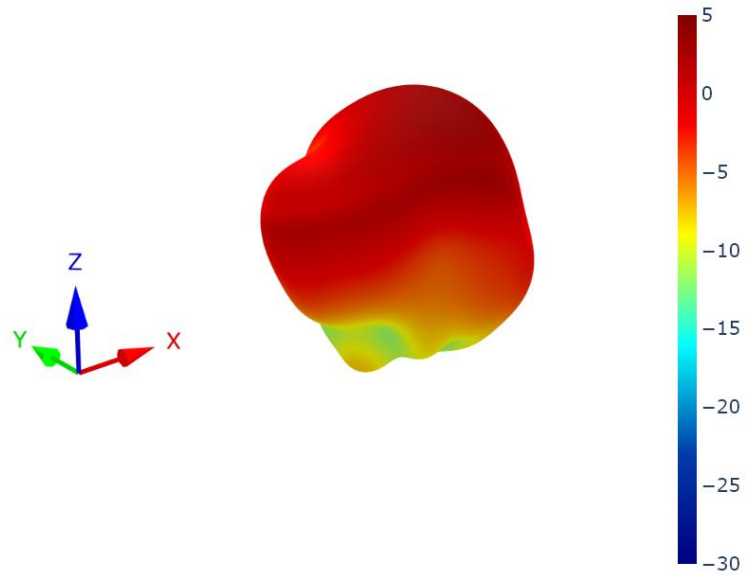

8.24 5G/4G-1 Patterns at 1920 MHz

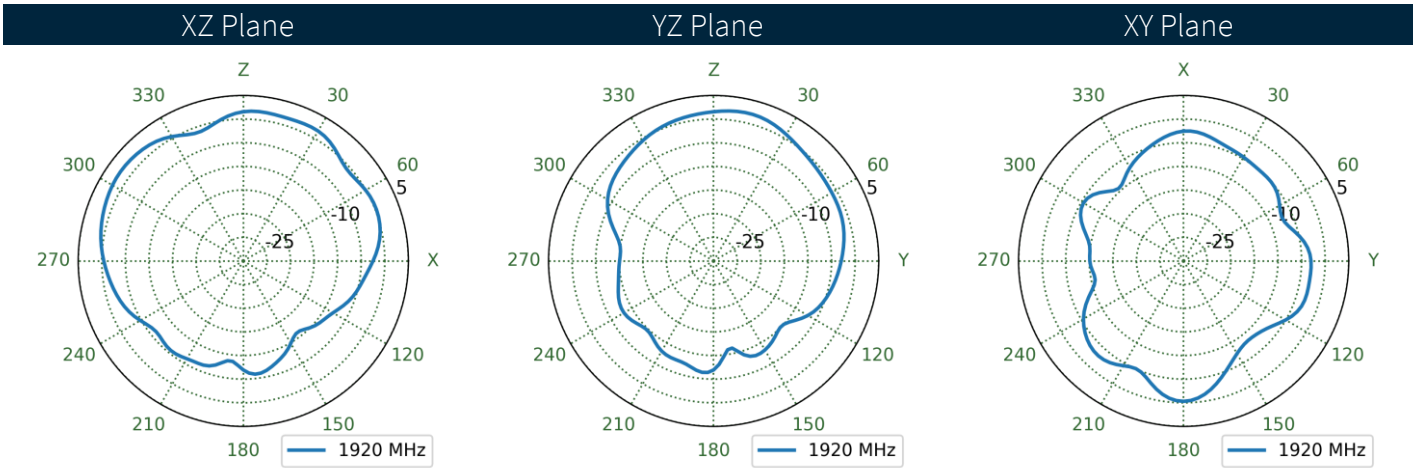
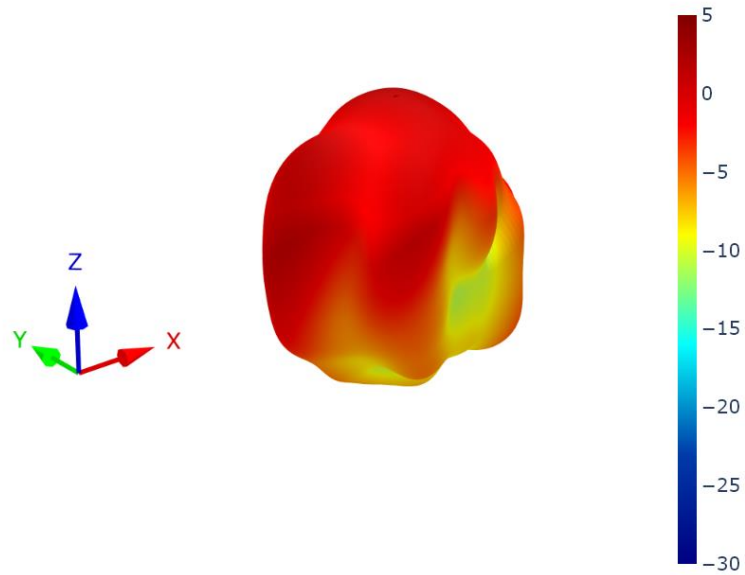

8.25 5G/4G-2 Patterns at 1920 MHz

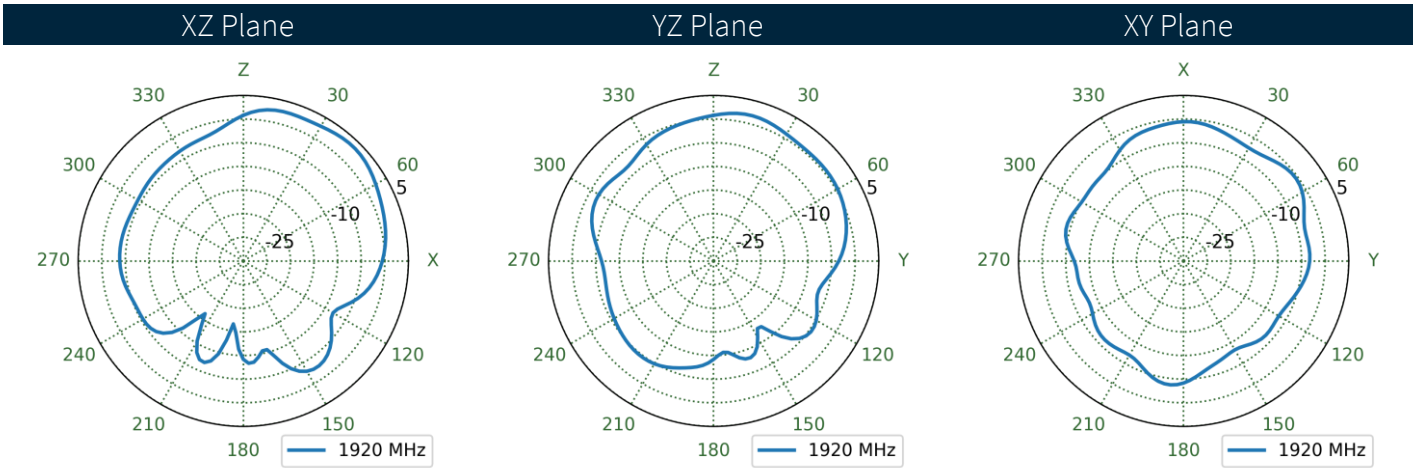
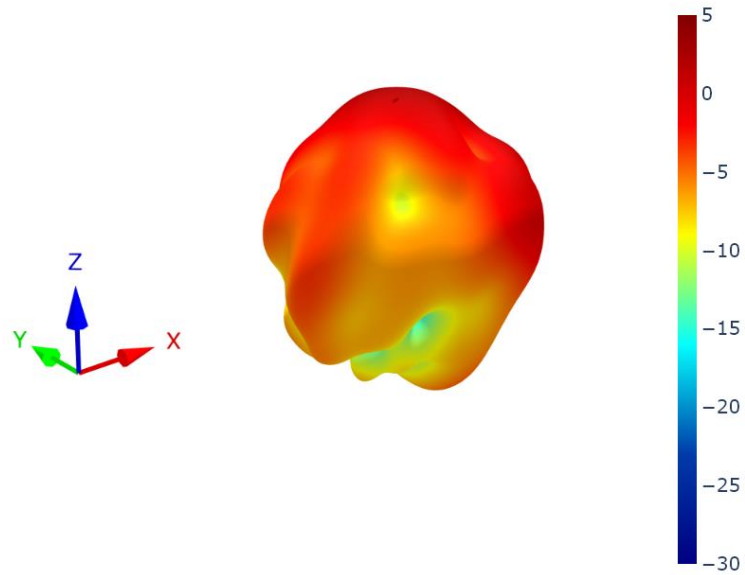

8.26 5G/4G-3 Patterns at 1920 MHz

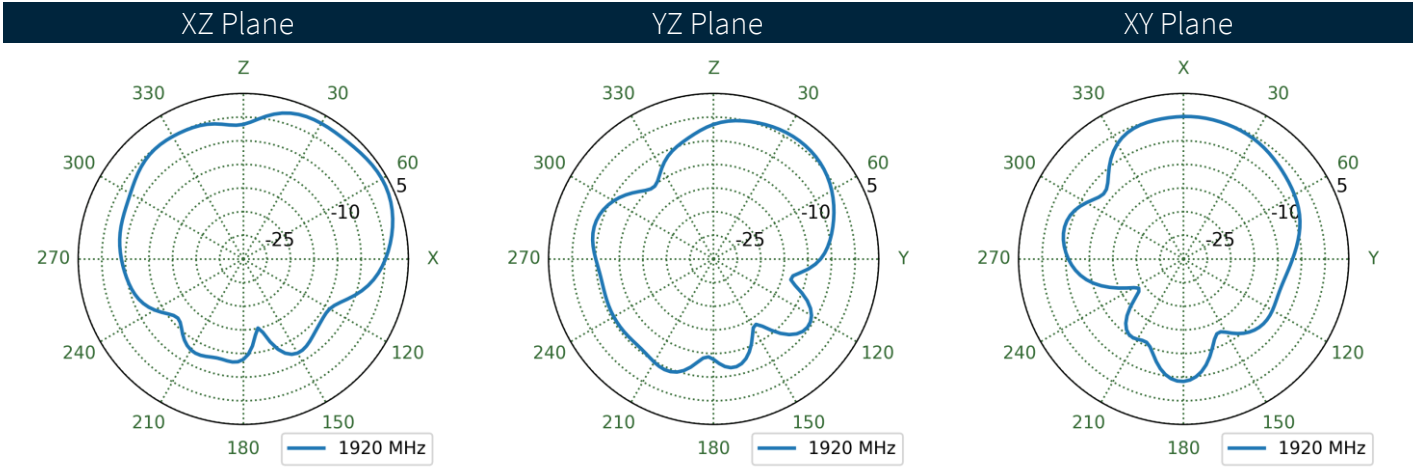
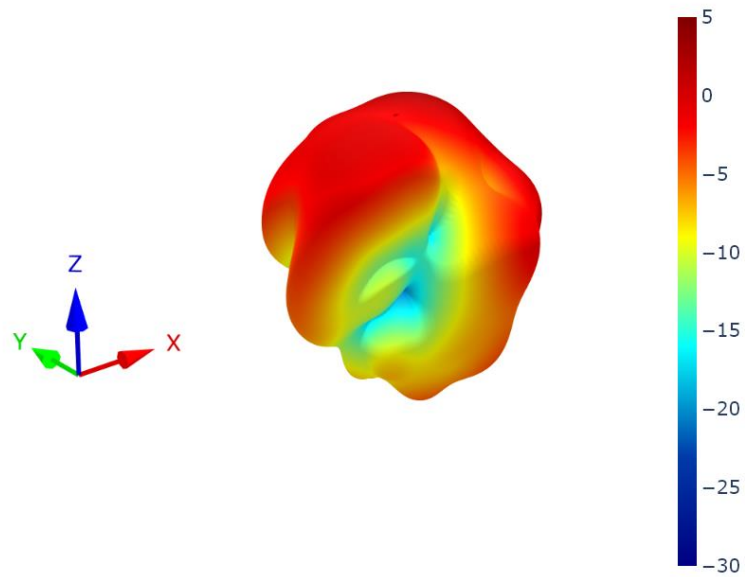

8.27 5G/4G-4 Patterns at 1920 MHz

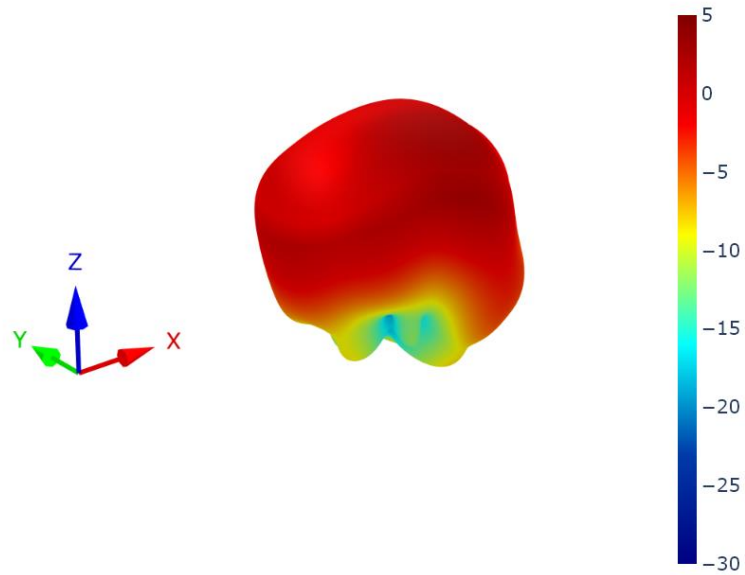

XZ Plane YZ Plane XY Plane

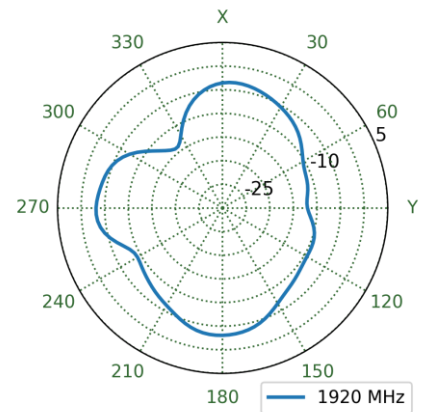
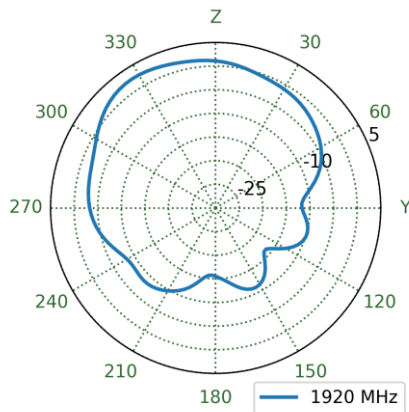
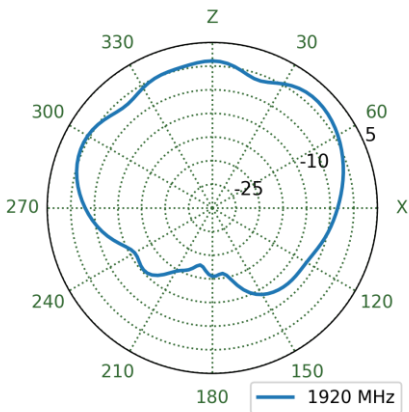

8.28 5G/4G-1 Patterns at 1990 MHz

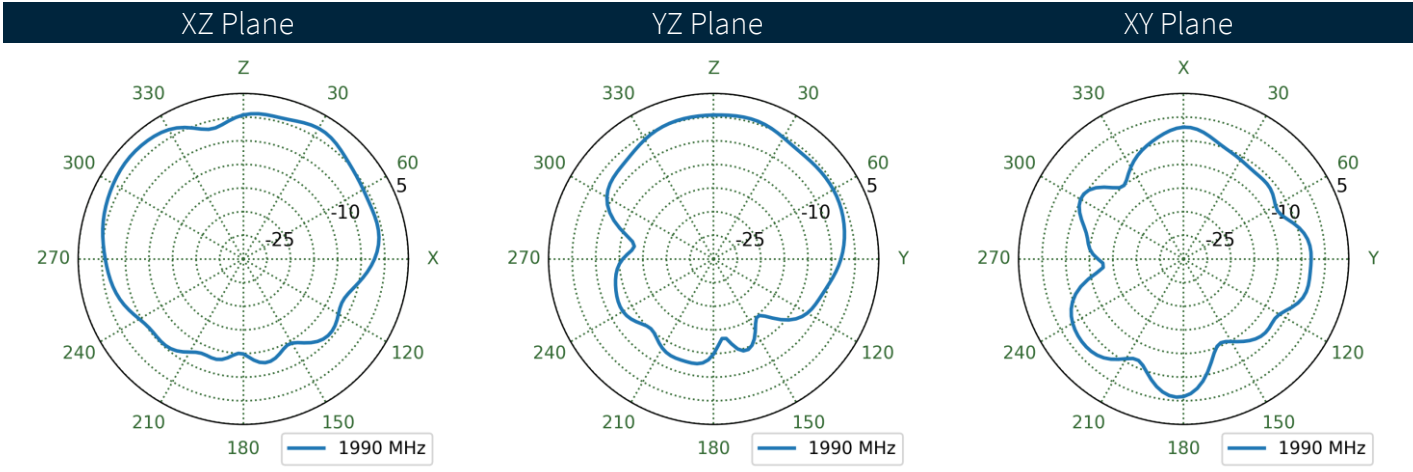
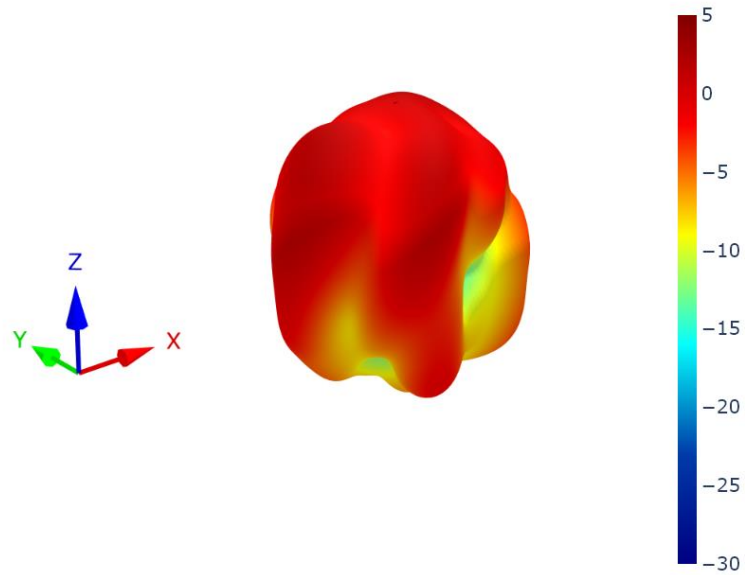

8.29 5G/4G-2 Patterns at 1990 MHz

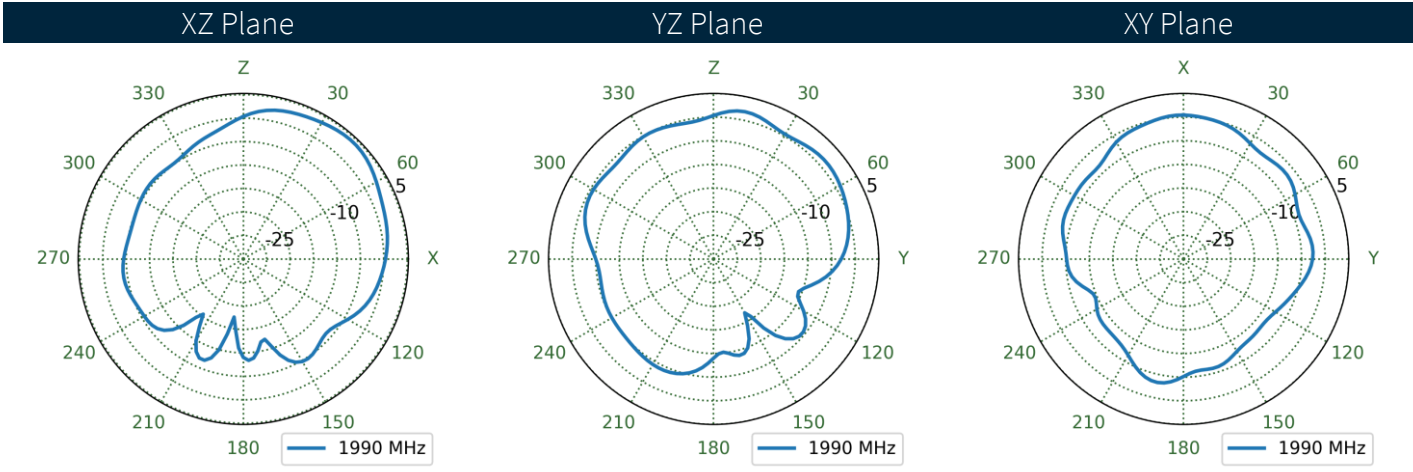
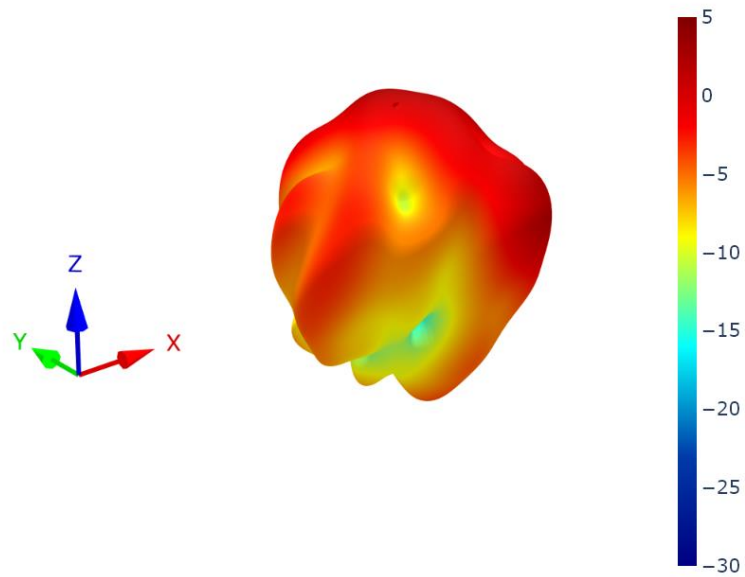

8.30 5G/4G-3 Patterns at 1990 MHz

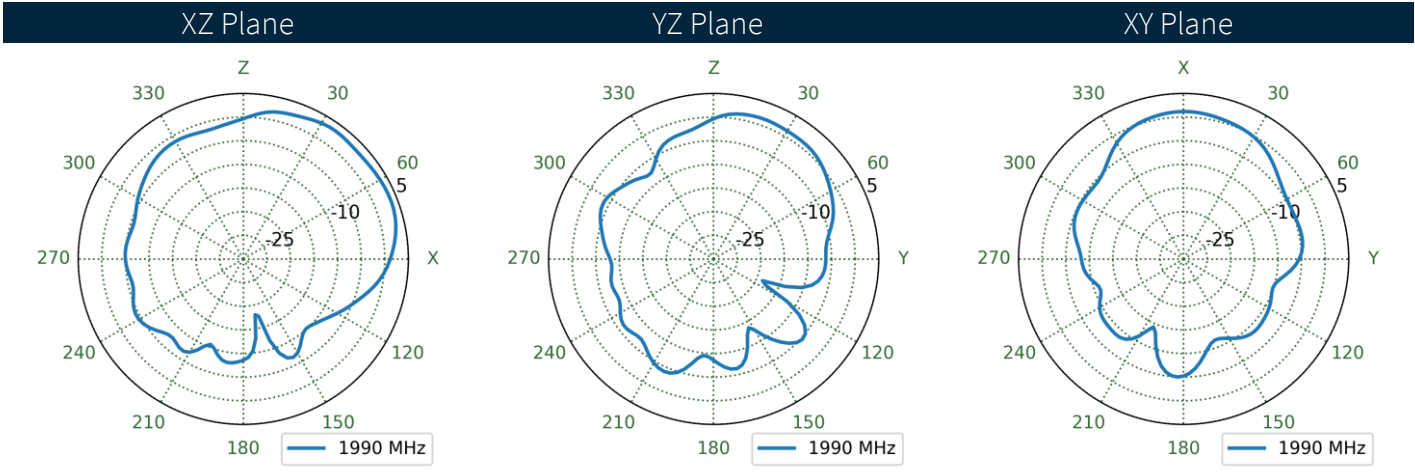
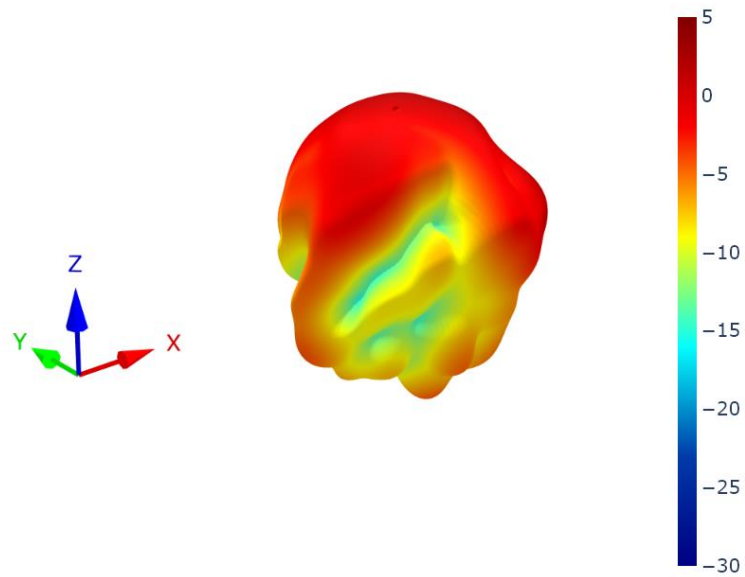

8.31 5G/4G-4 Patterns at 1990 MHz

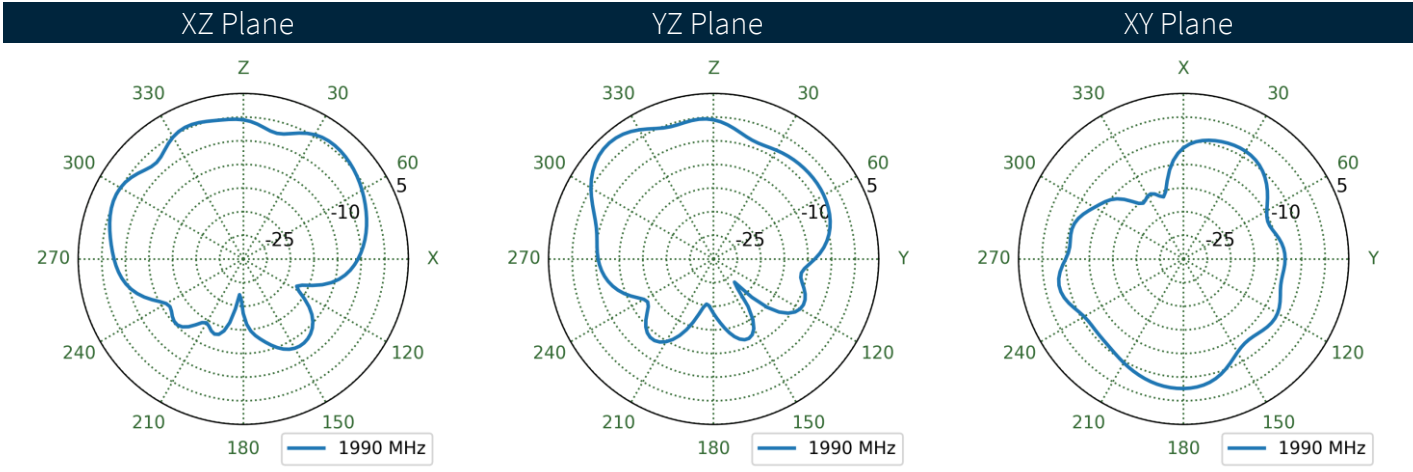
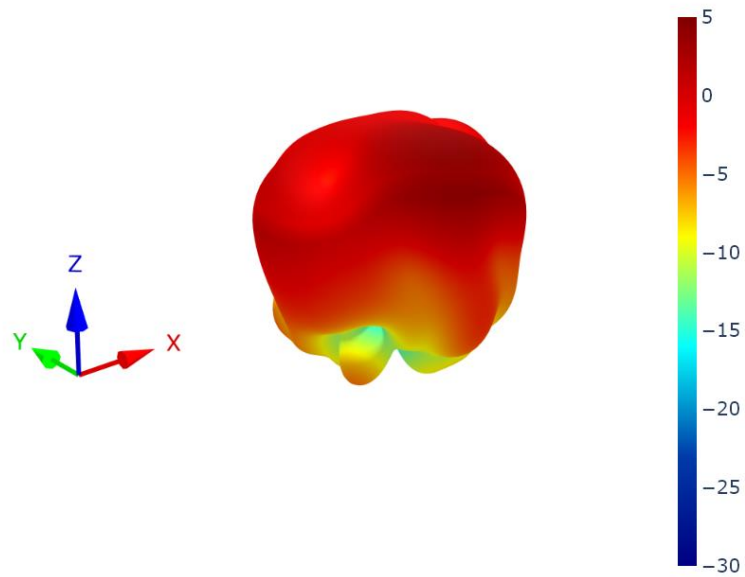

8.32 5G/4G-1 Patterns at 2360 MHz

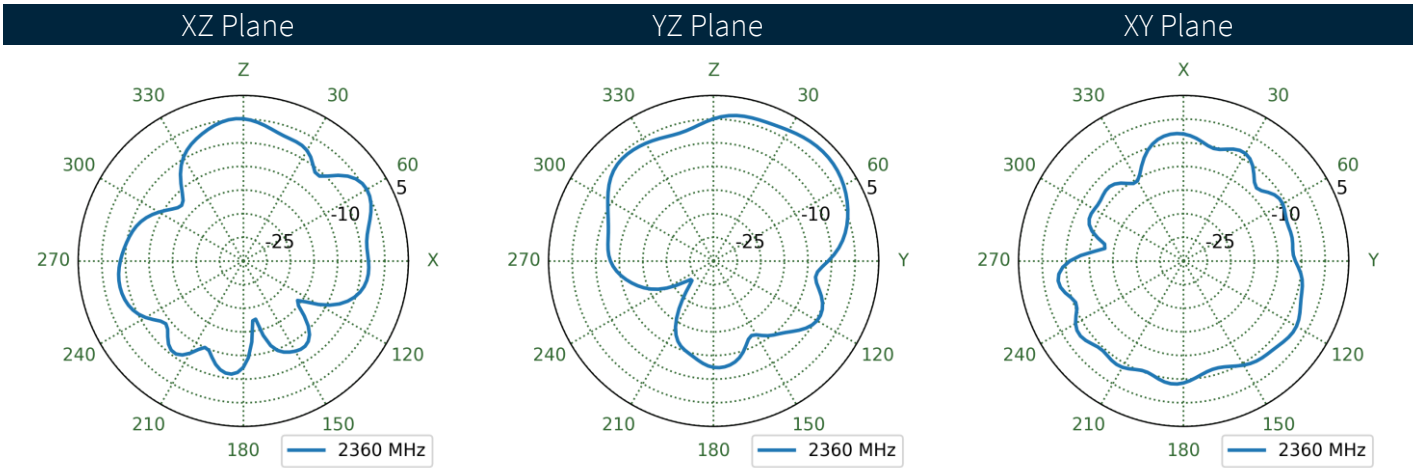
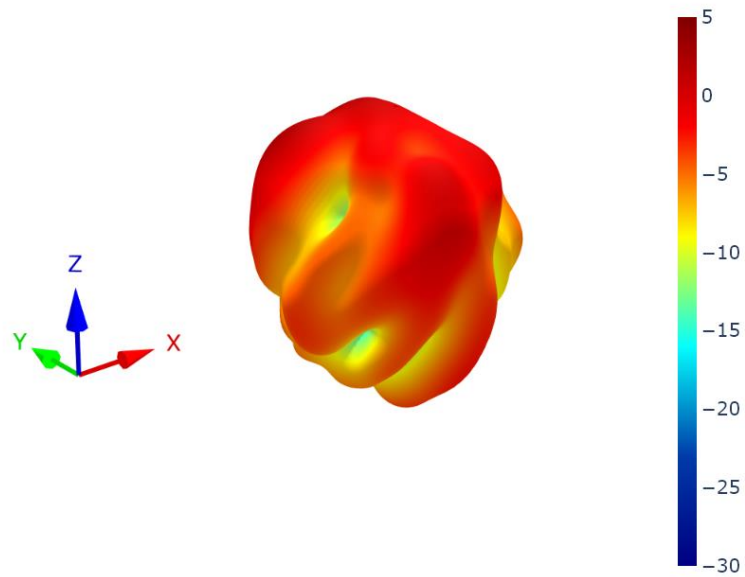

8.33 5G/4G-2 Patterns at 2360 MHz

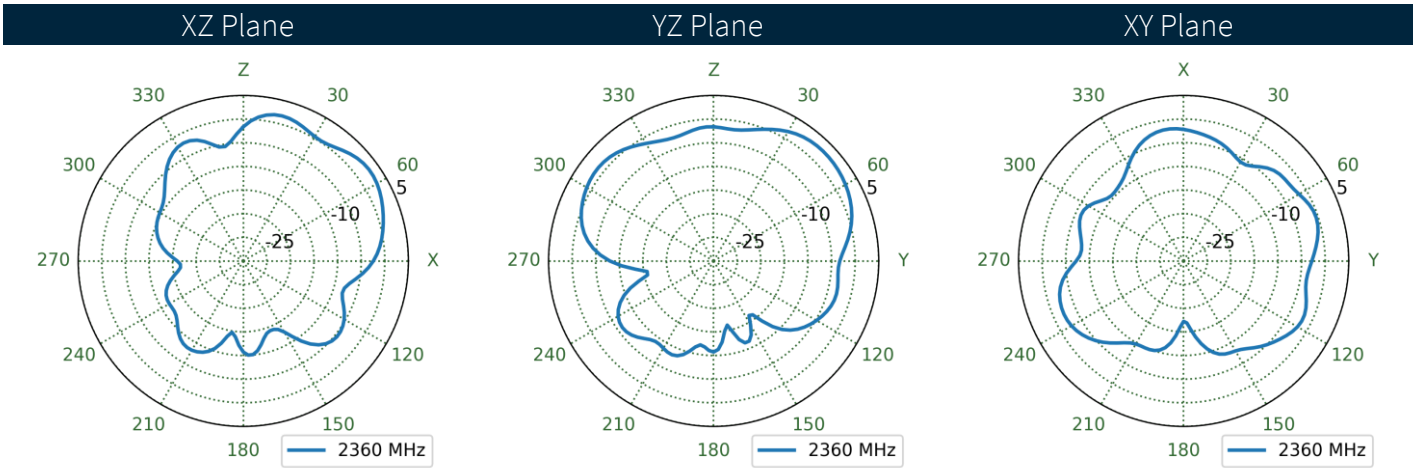
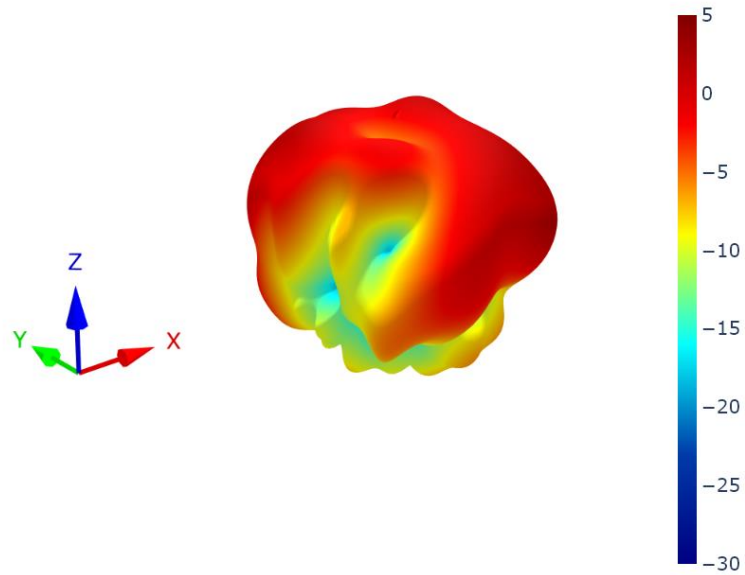

8.34 5G/4G-3 Patterns at 2360 MHz

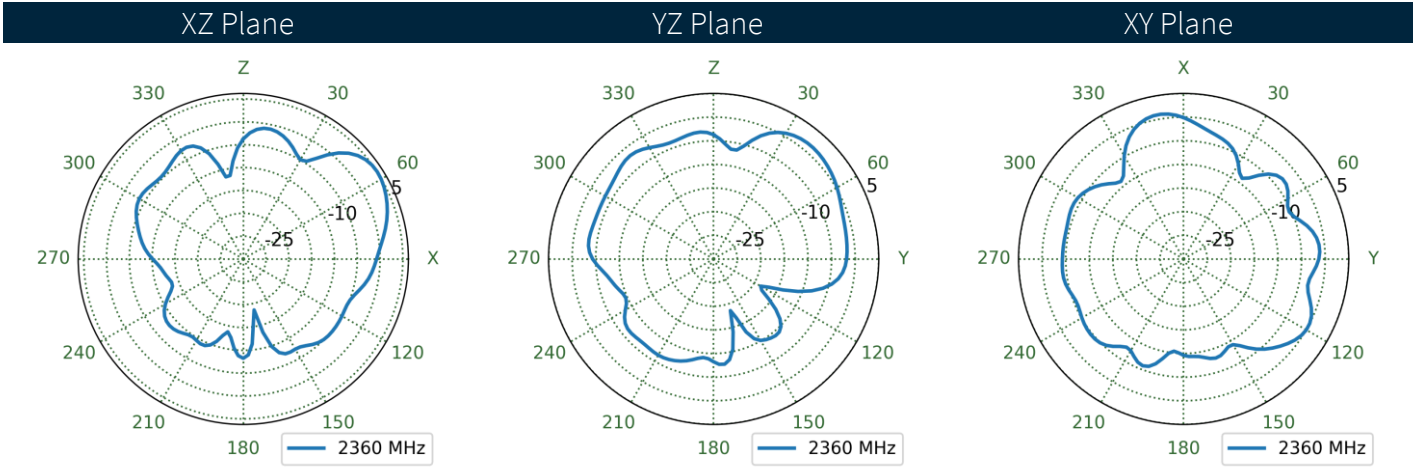
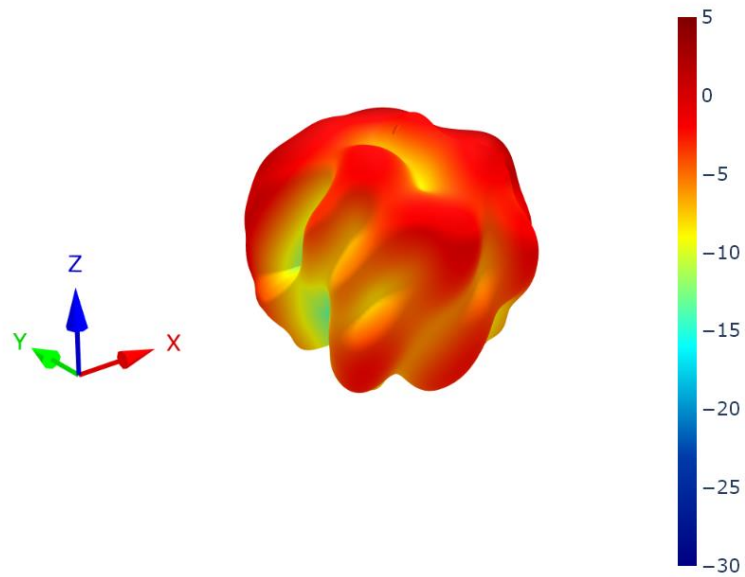

8.35 5G/4G-4 Patterns at 2360 MHz

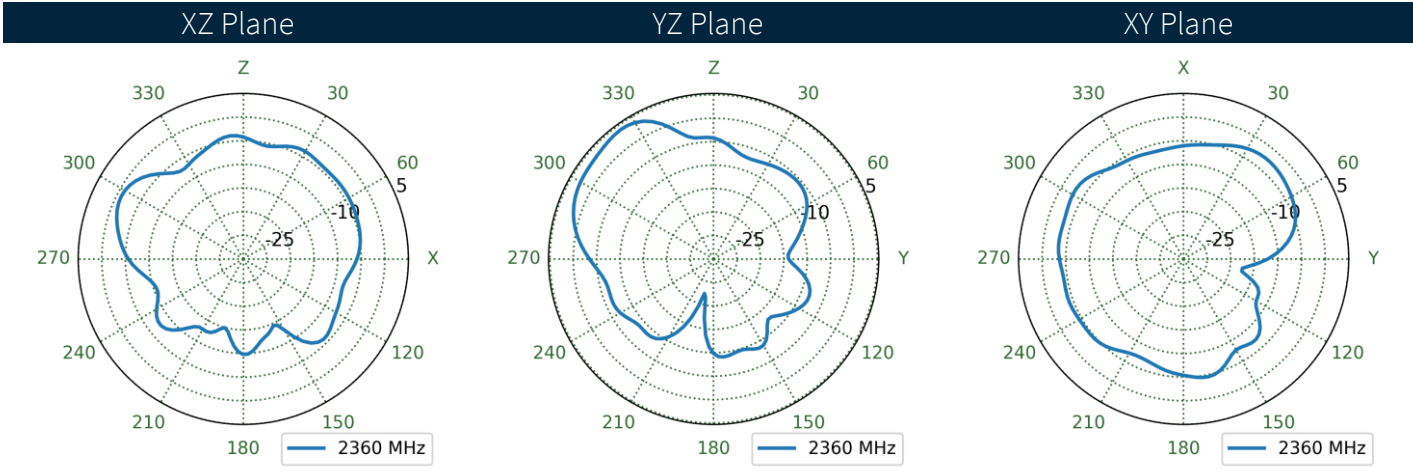
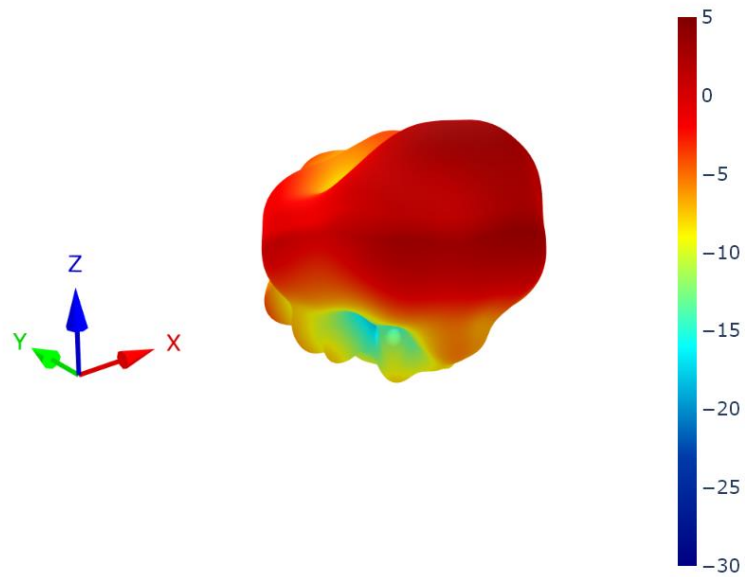

8.36 5G/4G-1 Patterns at 2595 MHz

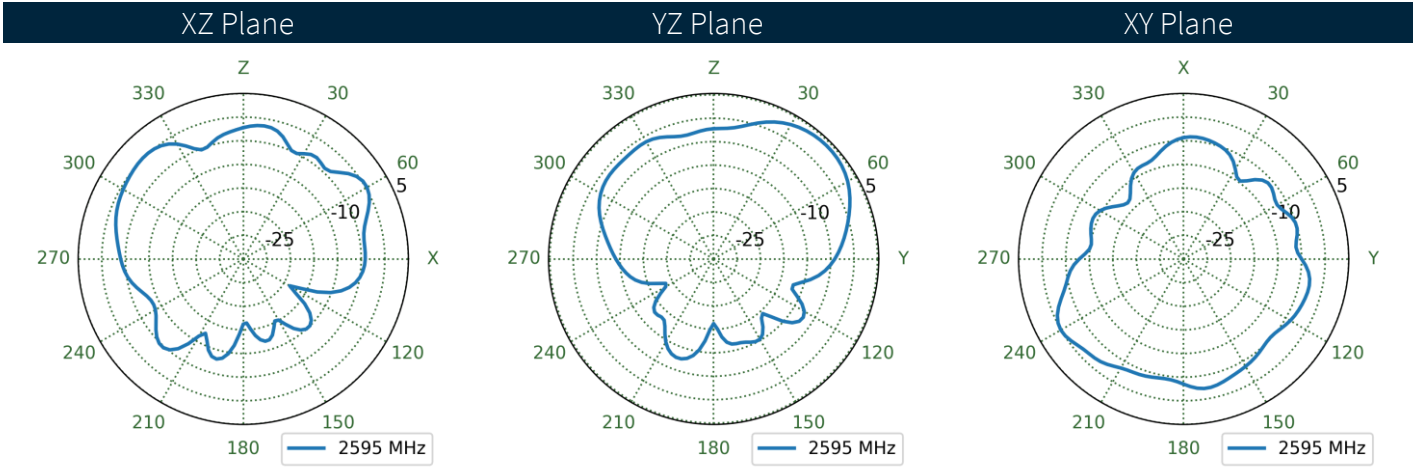
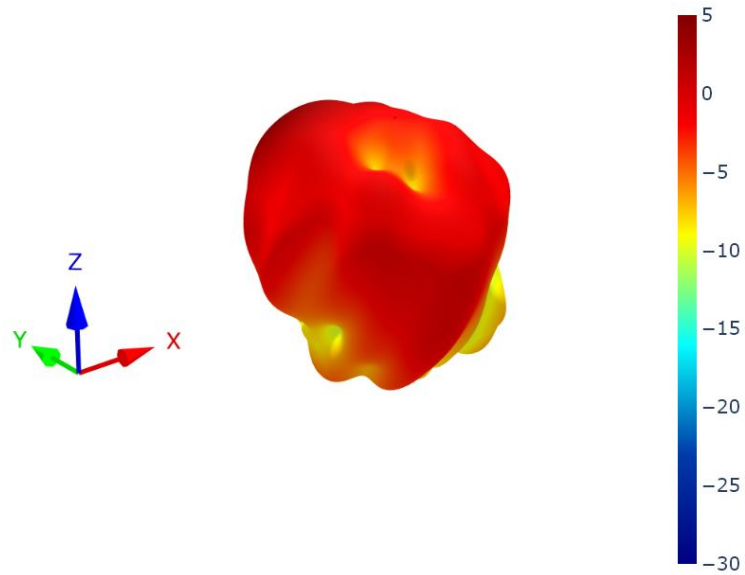

8.37 5G/4G-2 Patterns at 2595 MHz

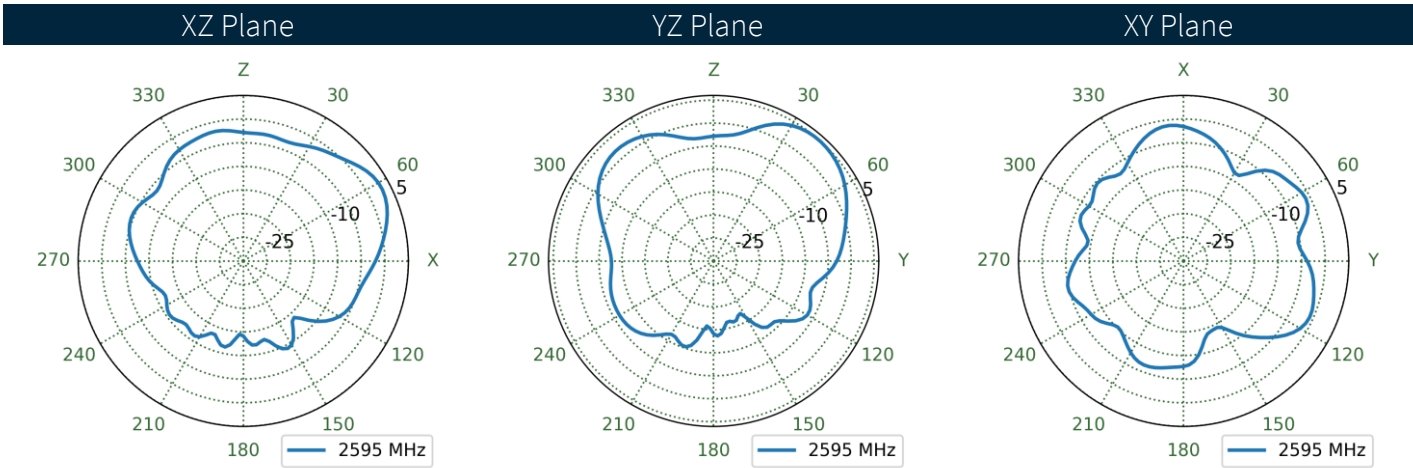
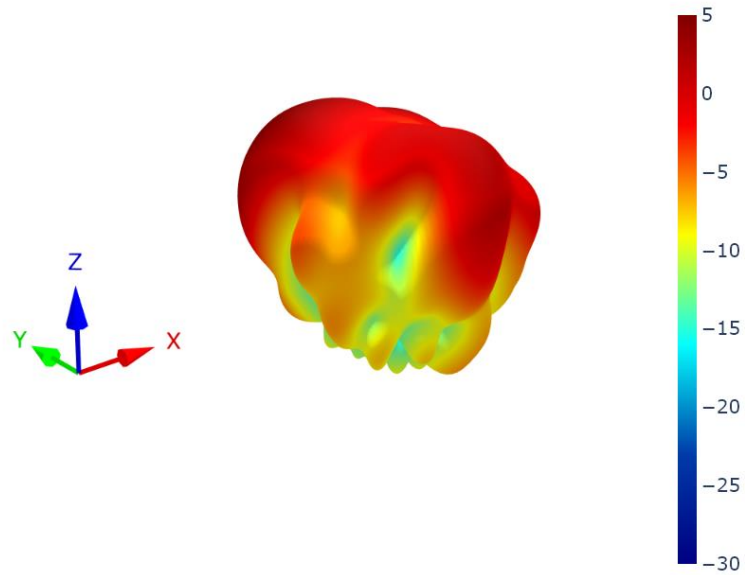

8.38 5G/4G-3 Patterns at 2595 MHz

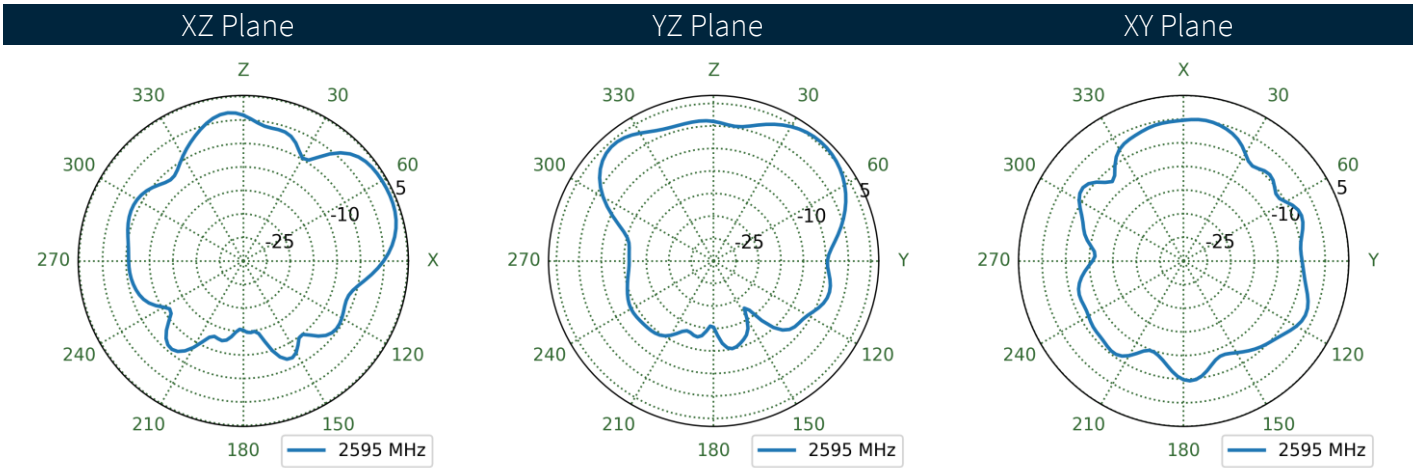
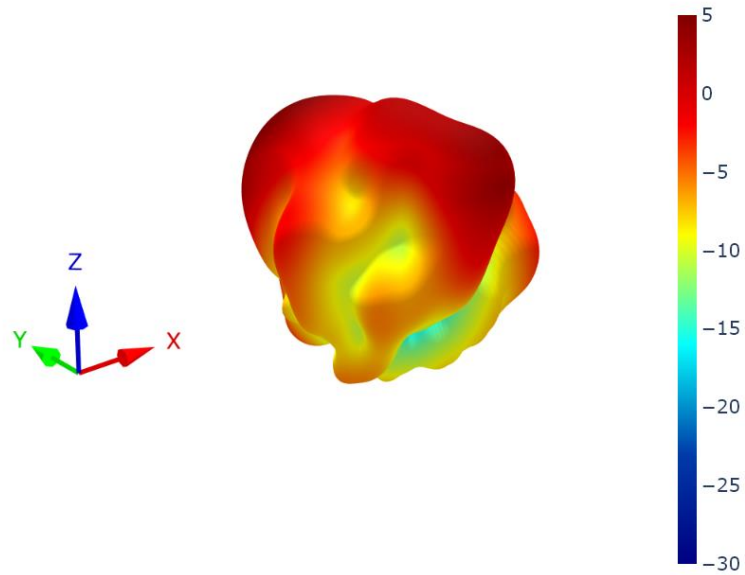

8.39 5G/4G-4 Patterns at 2595 MHz

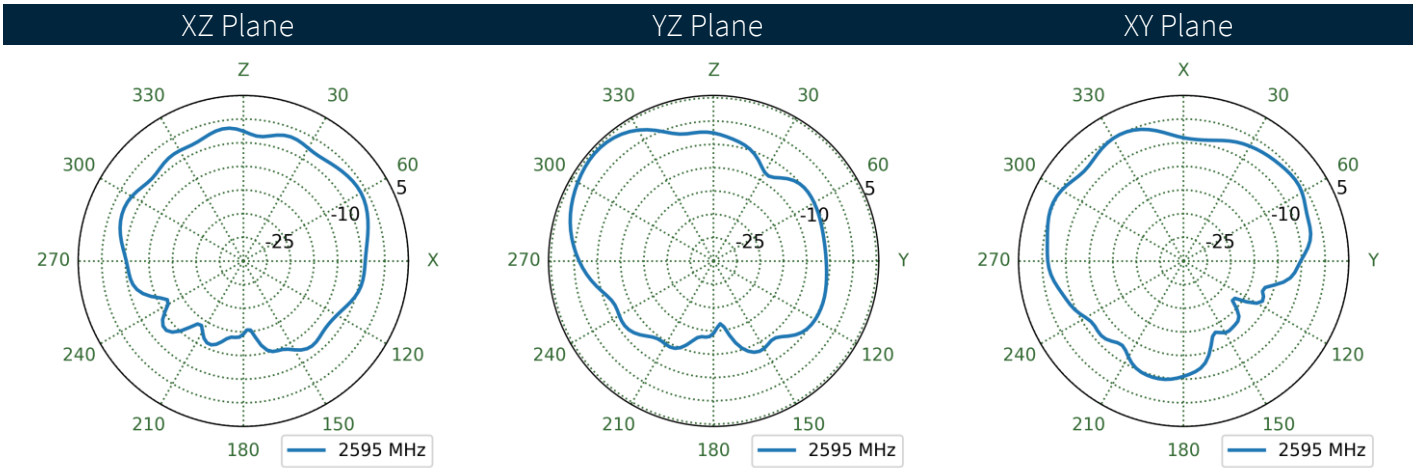
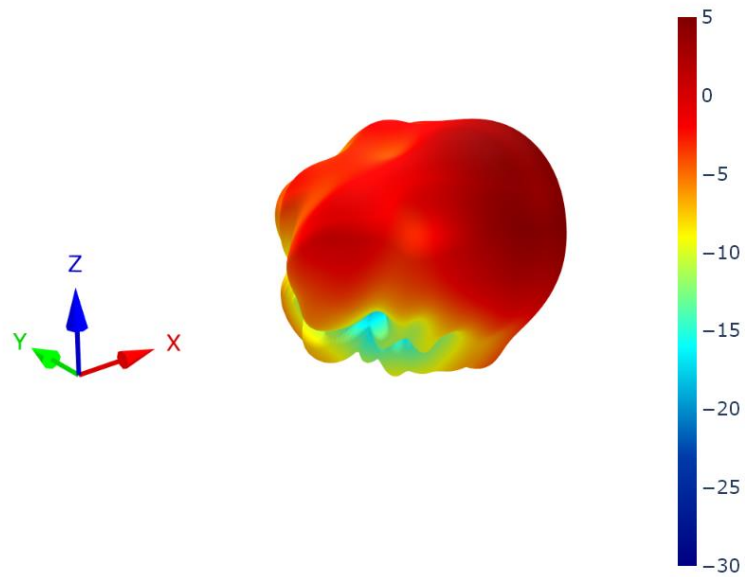

8.40 5G/4G-1 Patterns at 3550 MHz

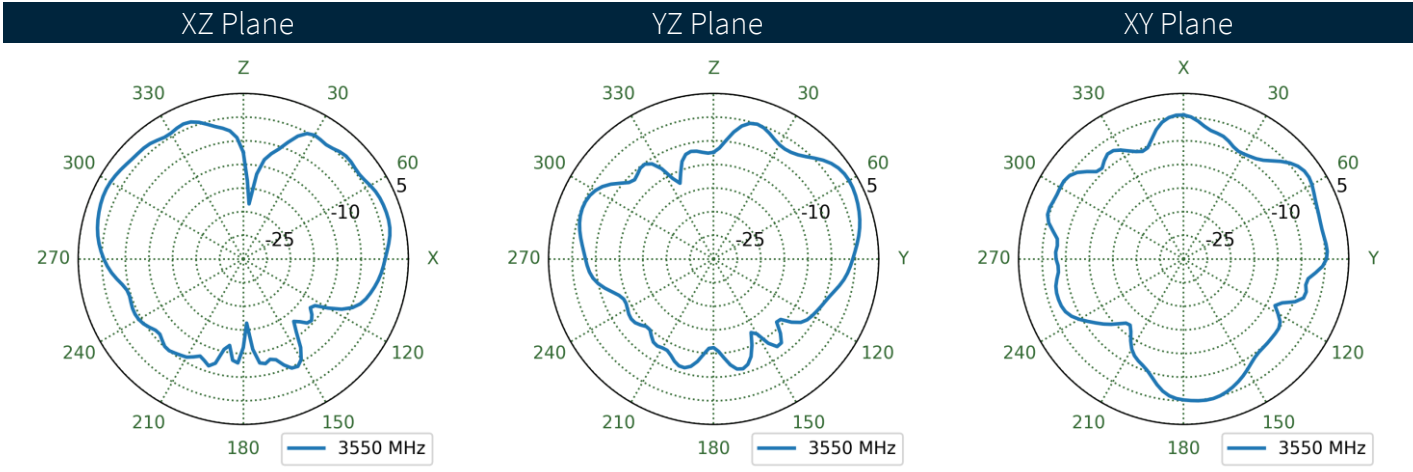
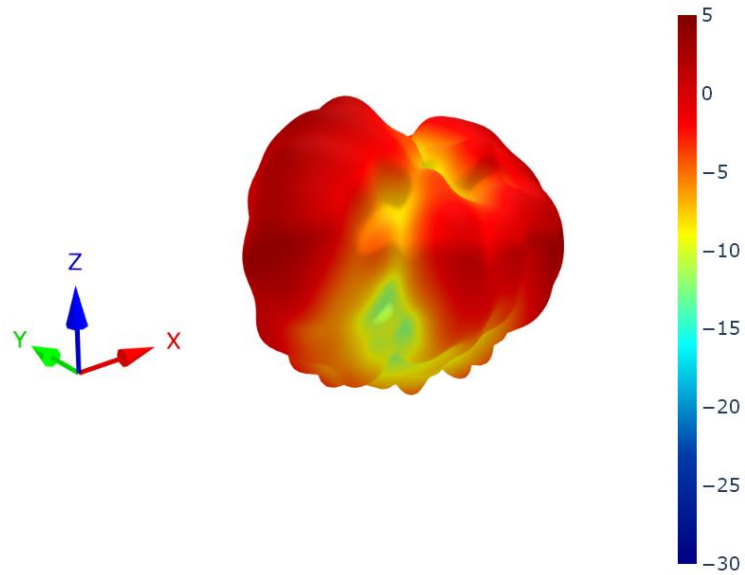

8.41 5G/4G-2 Patterns at 3550 MHz

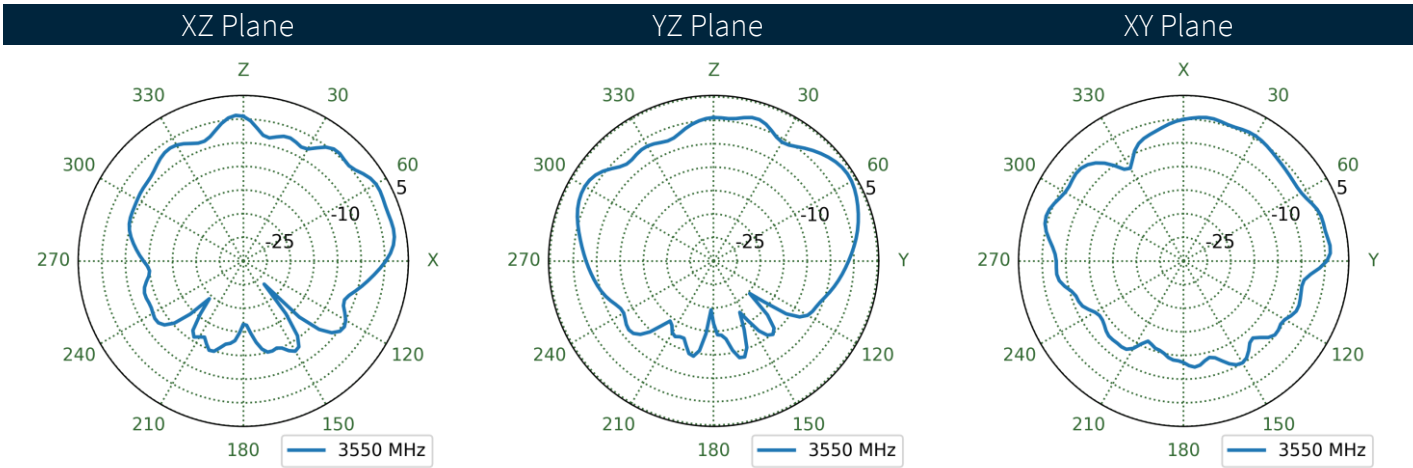
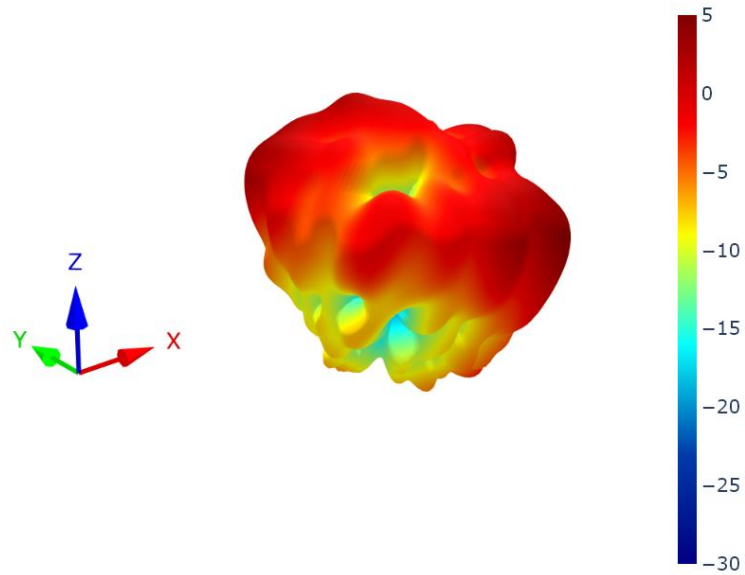

8.42 5G/4G-3 Patterns at 3550 MHz

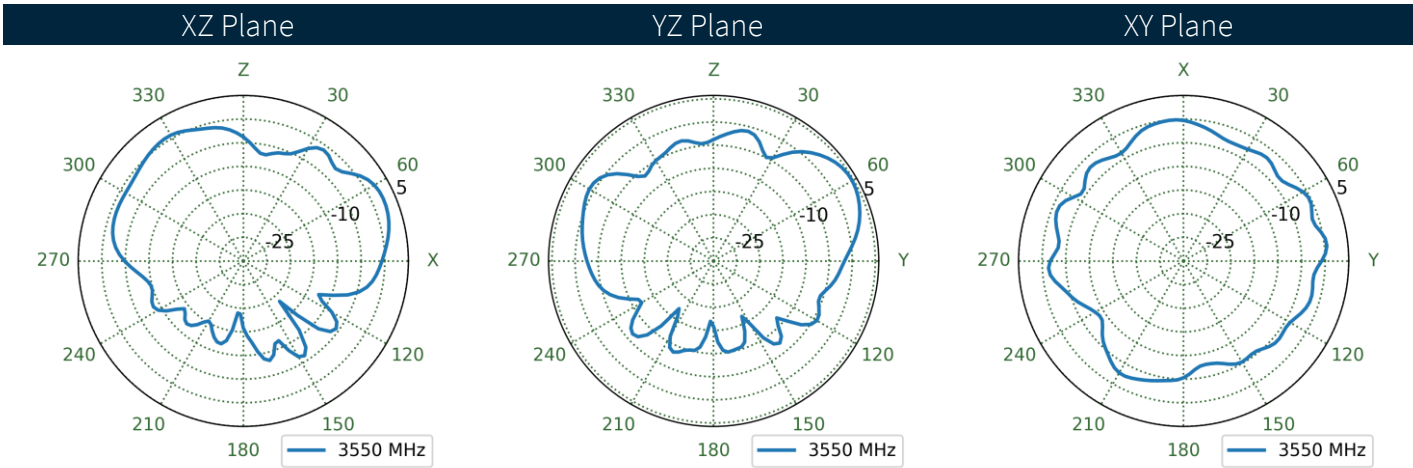
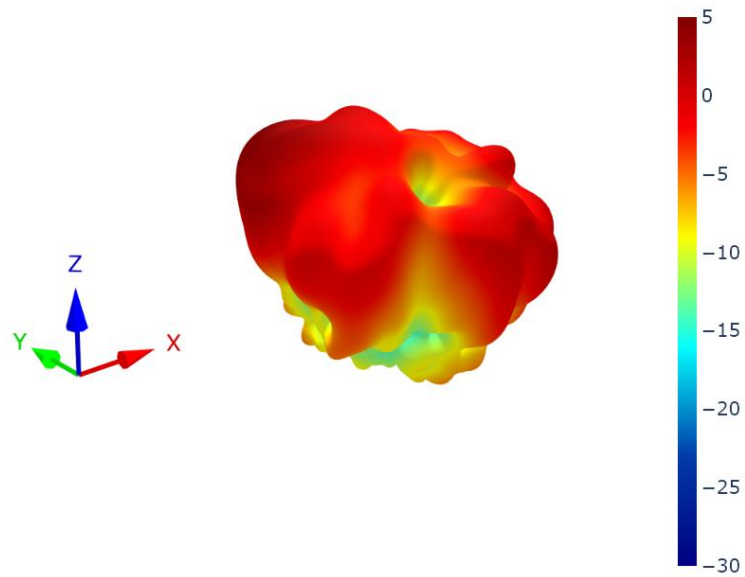

8.43 5G/4G-4 Patterns at 3550 MHz

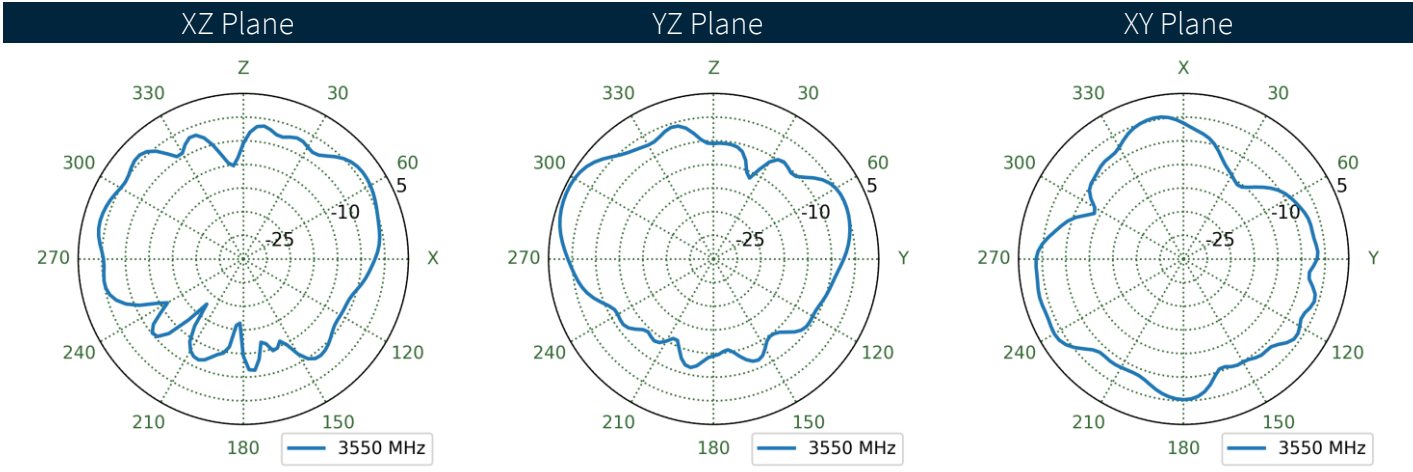
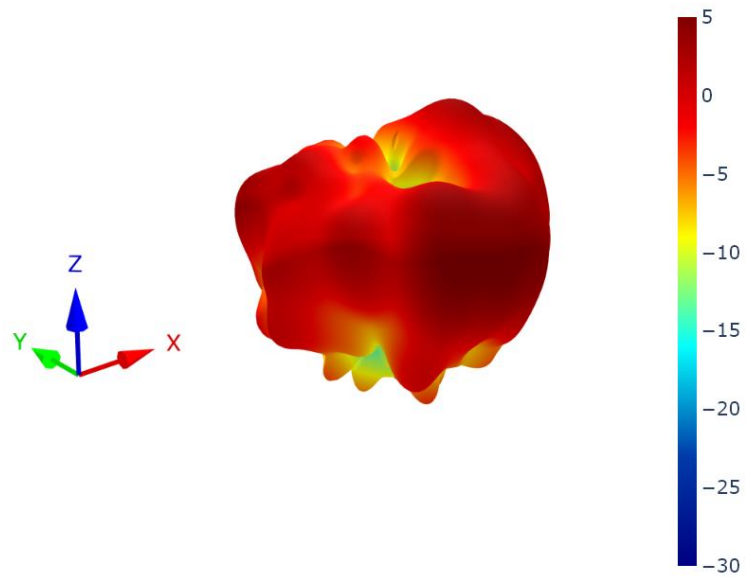

8.44 5G/4G-1 Patterns at 4600 MHz

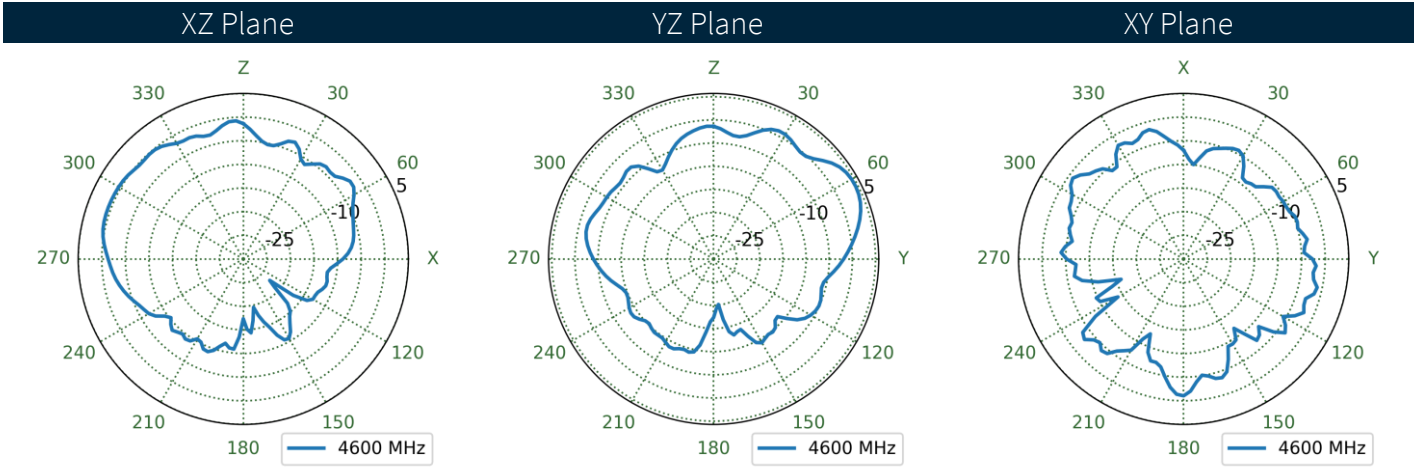
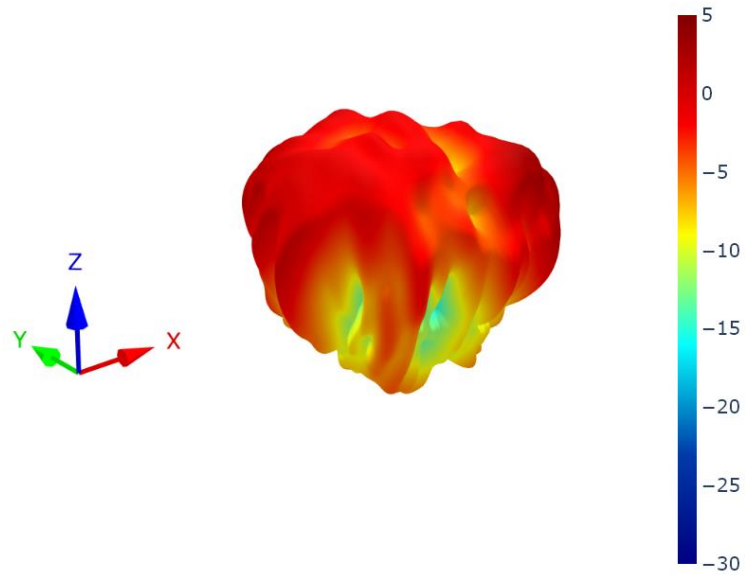

8.45 5G/4G-2 Patterns at 4600 MHz

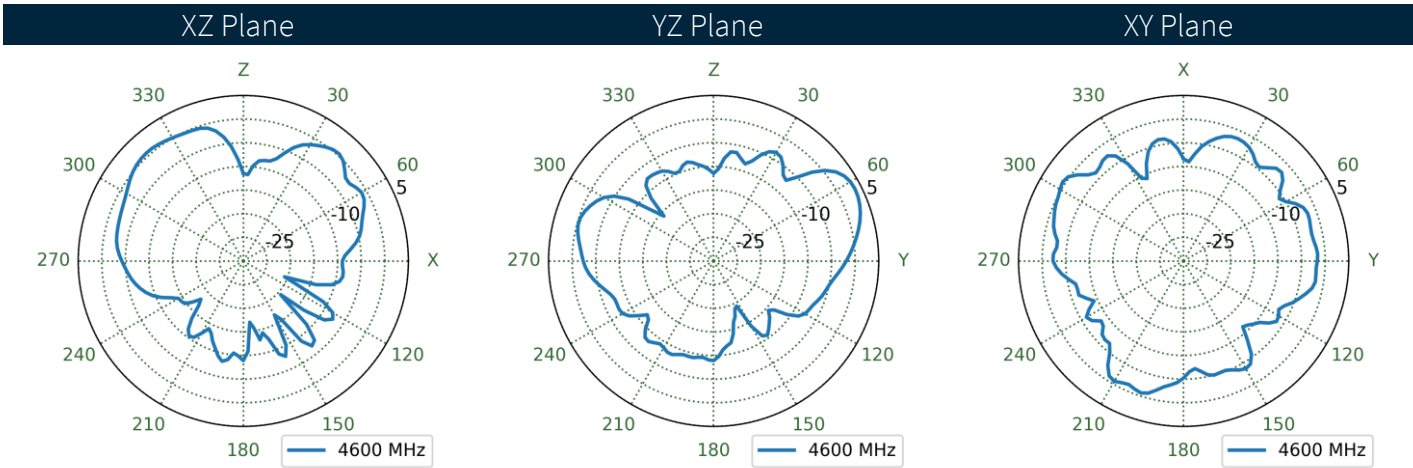
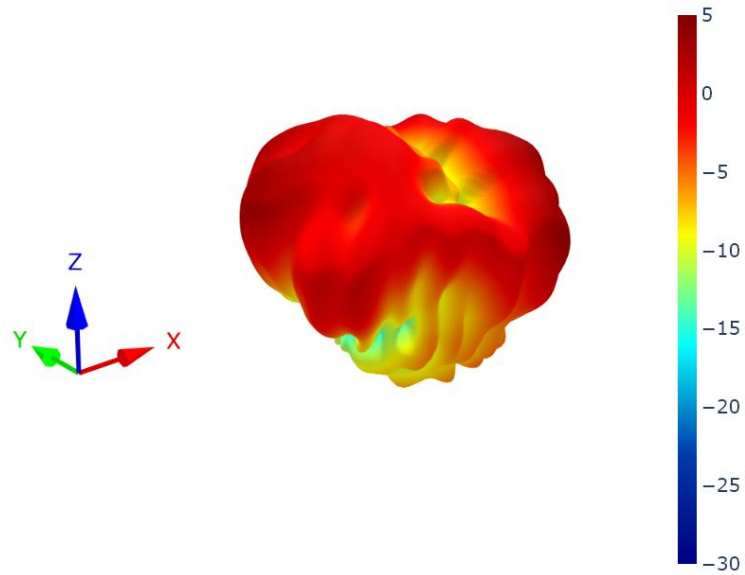

8.46 5G/4G-3 Patterns at 4600 MHz

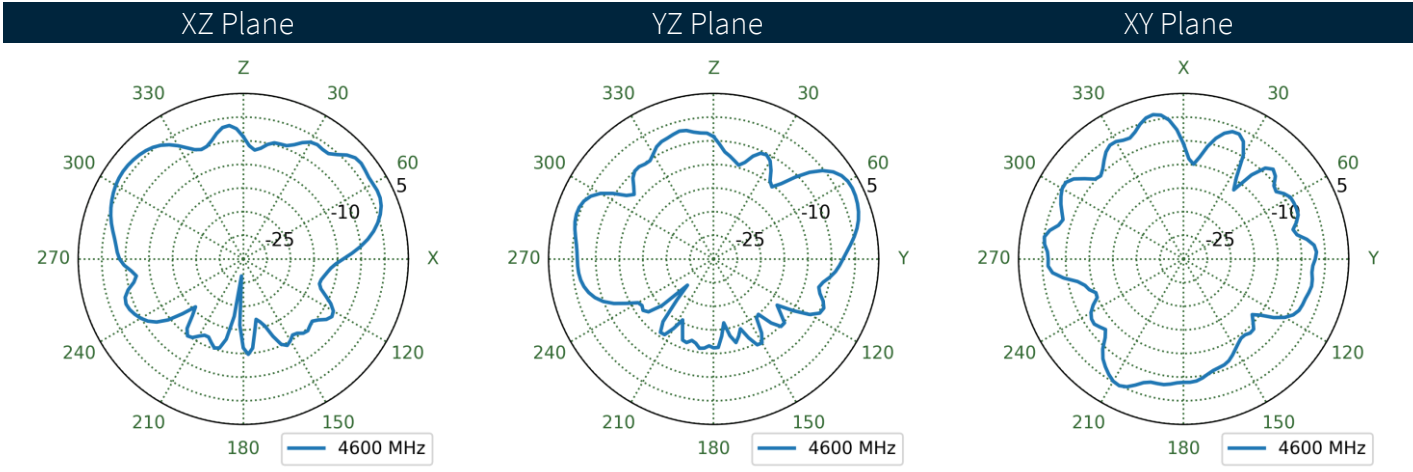
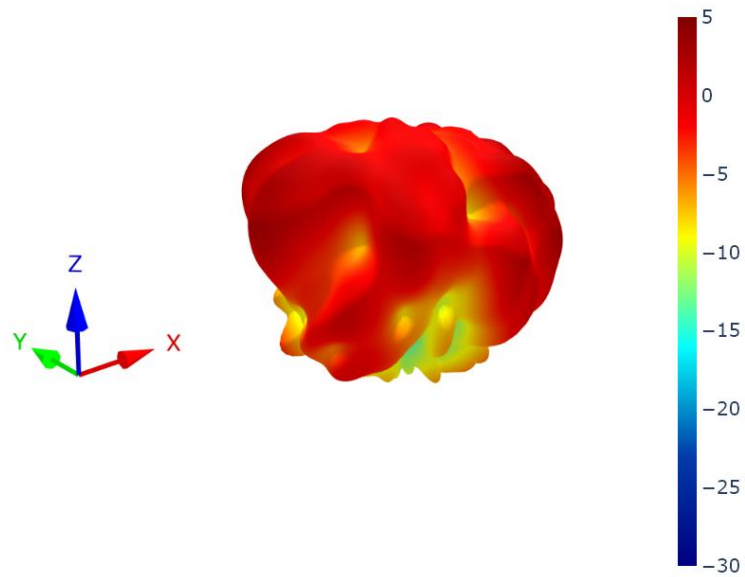

8.47 5G/4G-4 Patterns at 4600 MHz

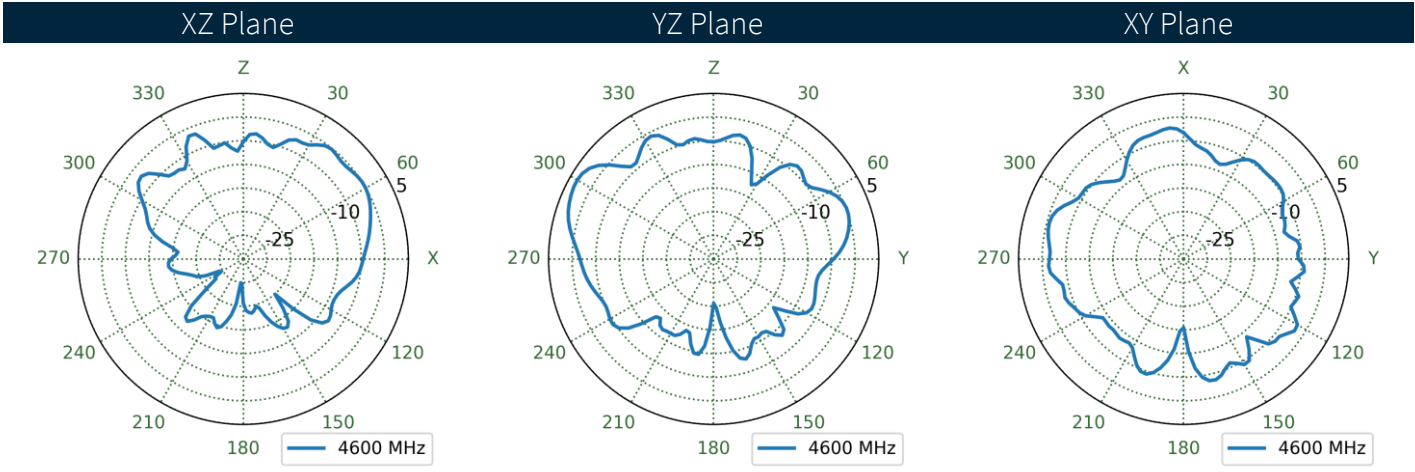
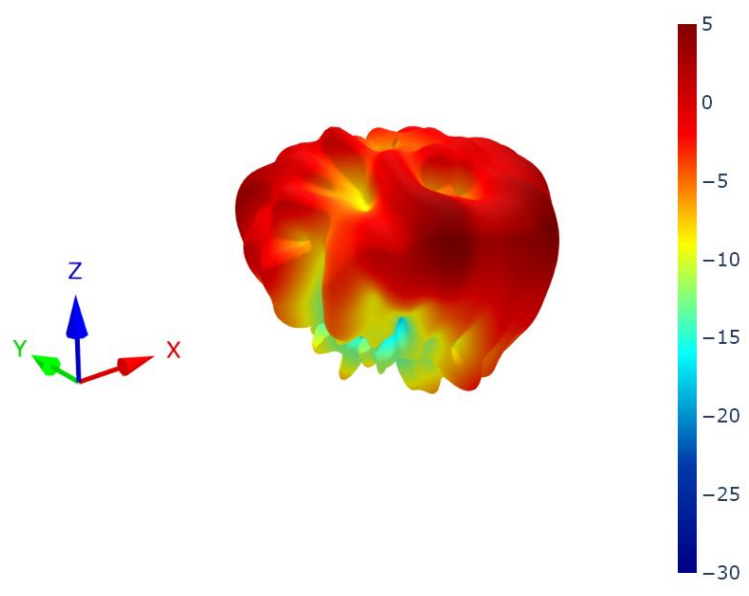

8.48 5G/4G-1 Patterns at 4800 MHz

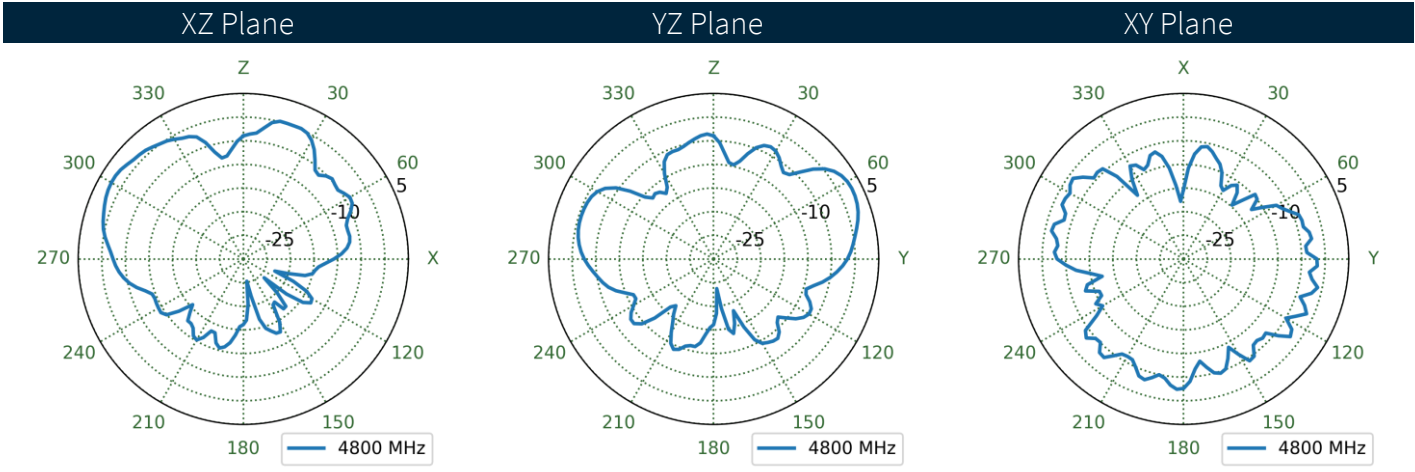
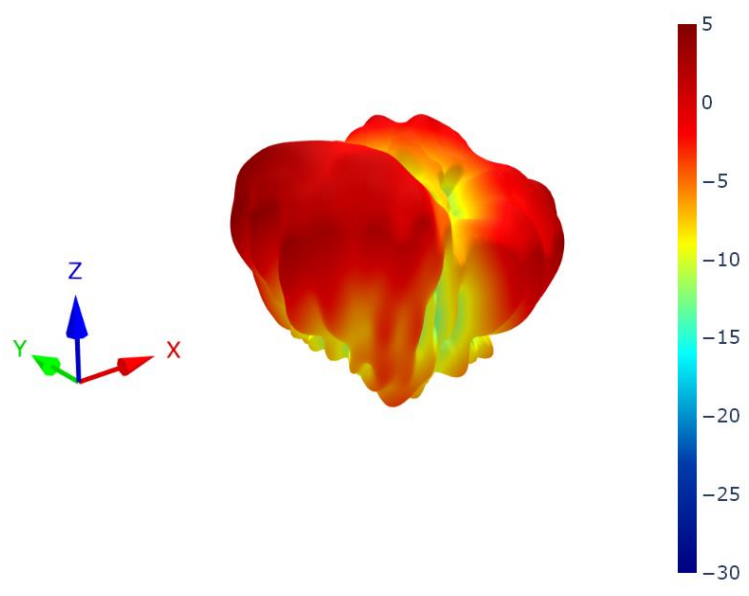

8.49 5G/4G-2 Patterns at 4800 MHz

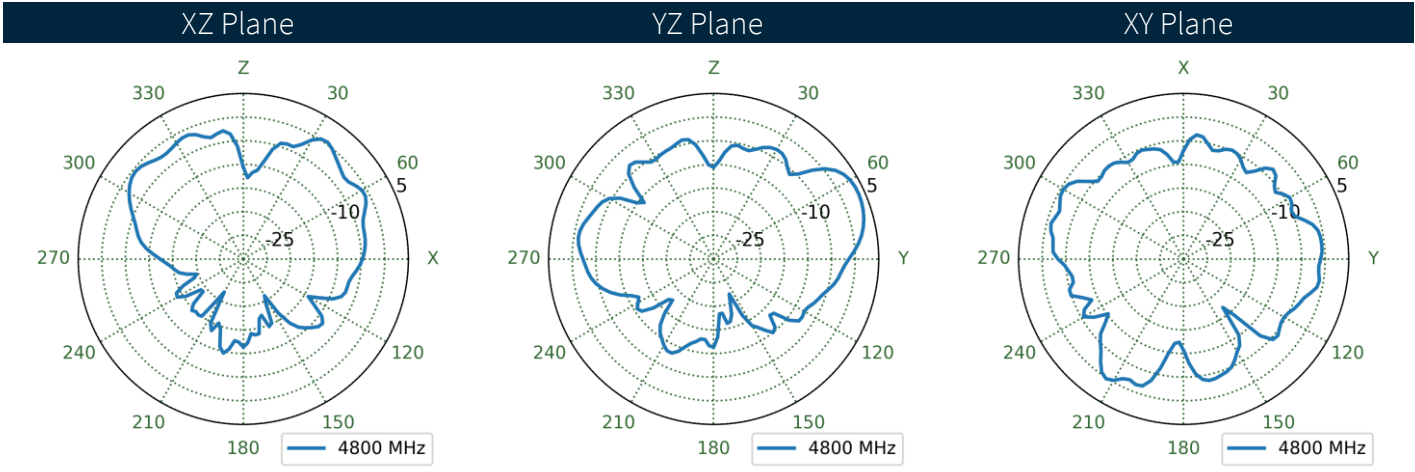
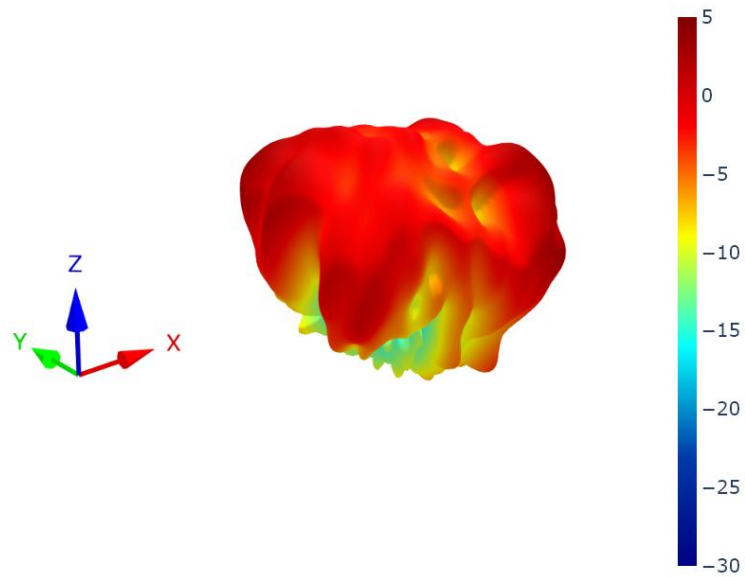

8.50 5G/4G-3 Patterns at 4800 MHz

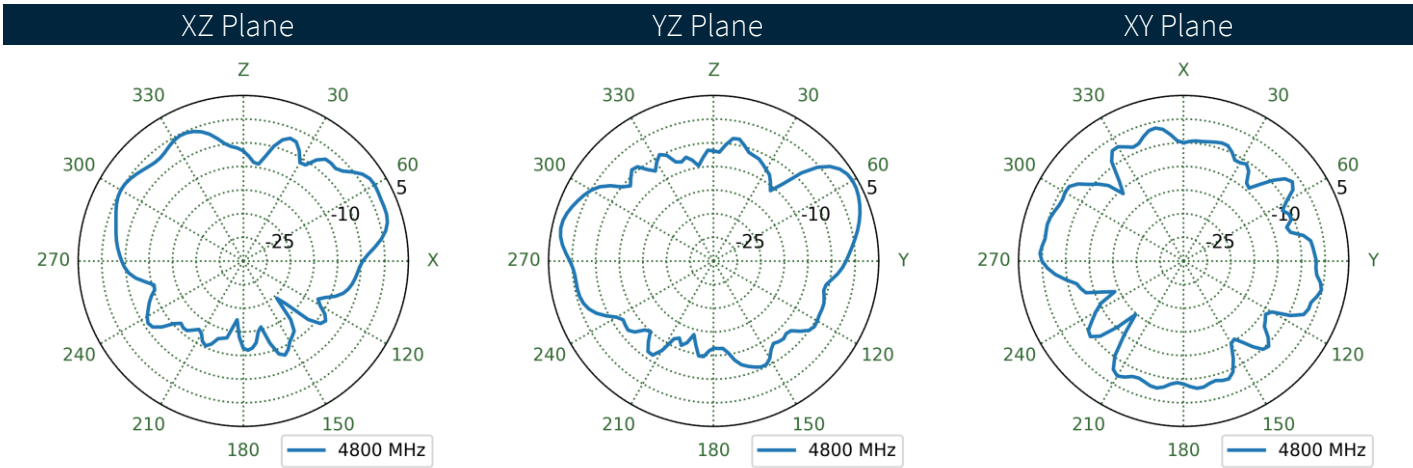
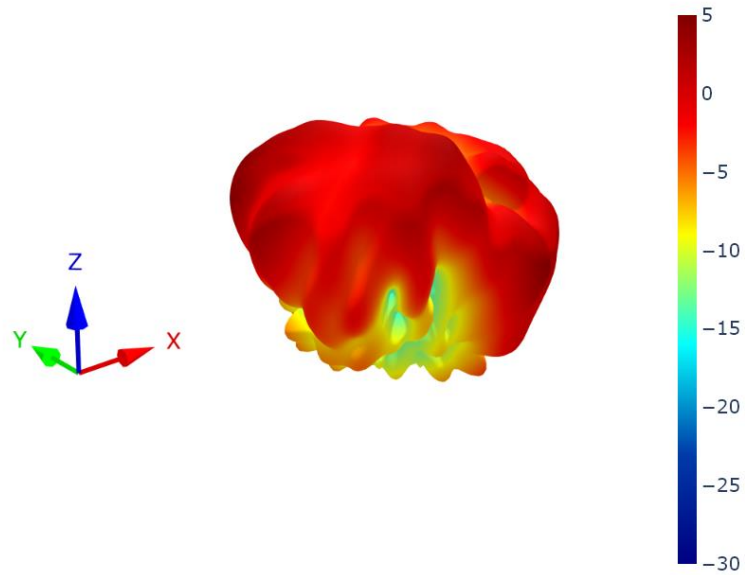

8.51 5G/4G-4 Patterns at 4800 MHz

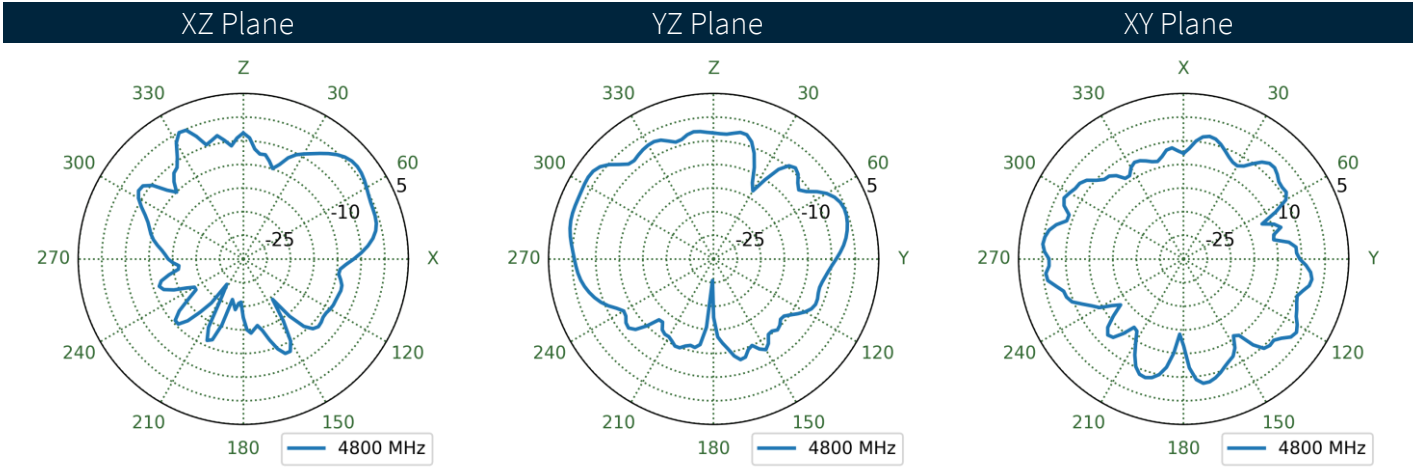
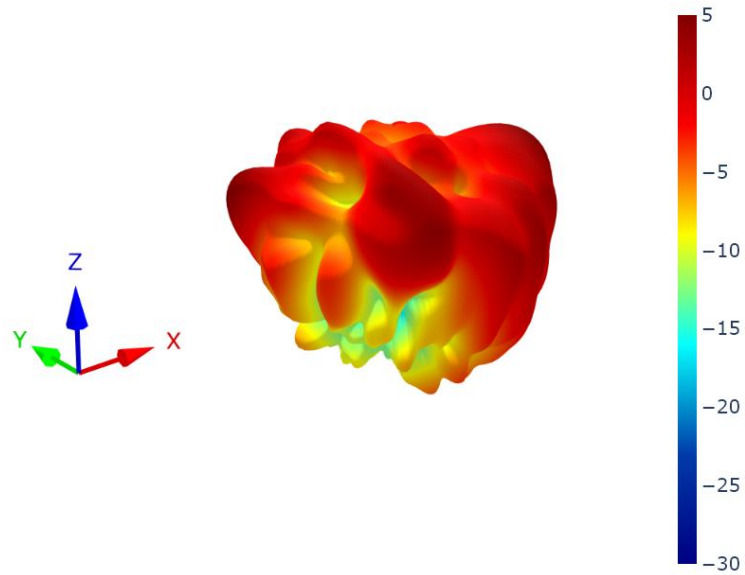

8.52 5G/4G-1 Patterns at 5530 MHz

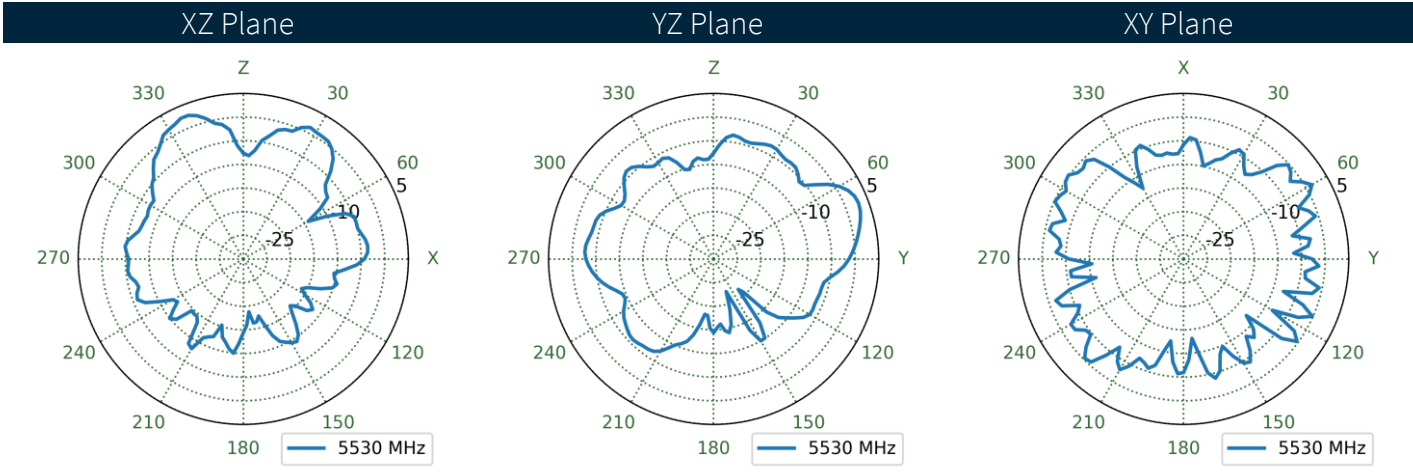
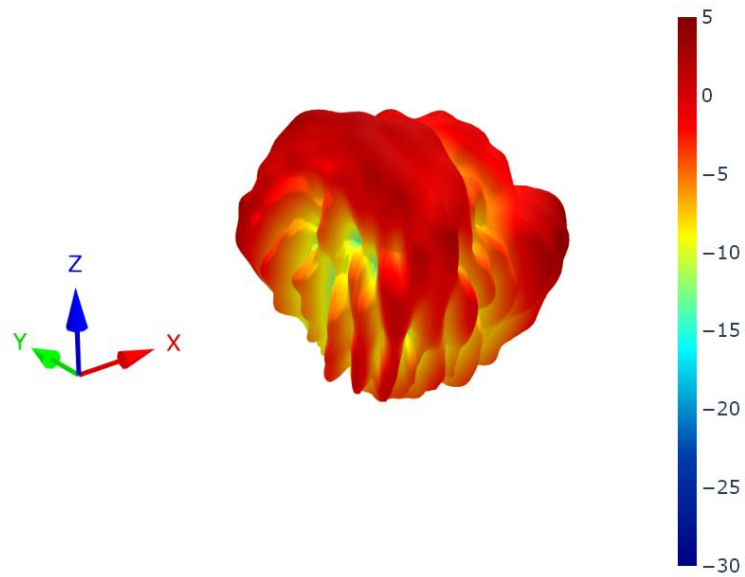

8.53 5G/4G-2 Patterns at 5530 MHz

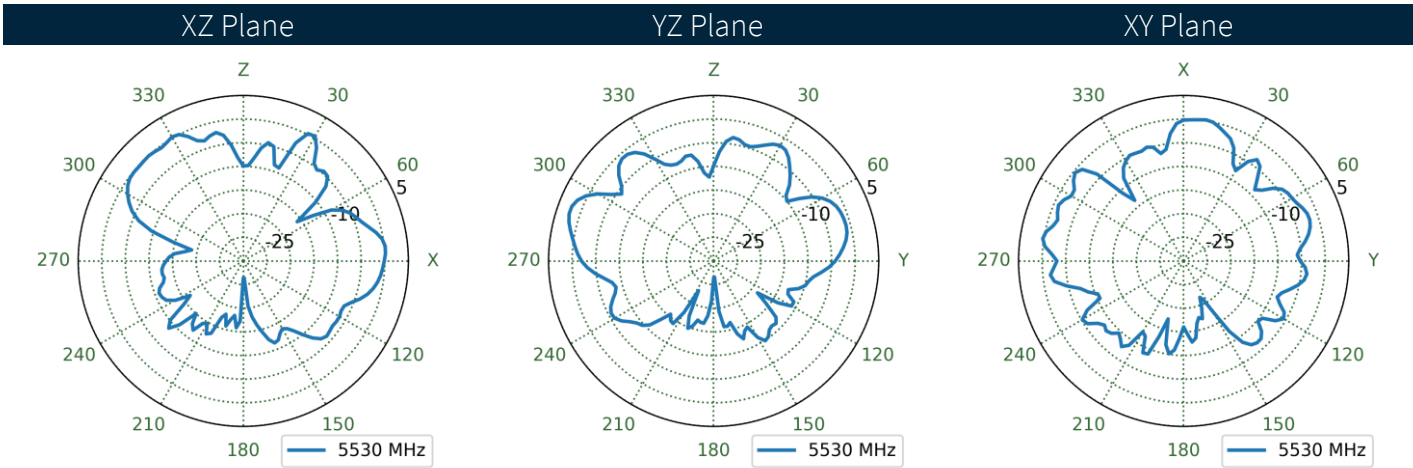
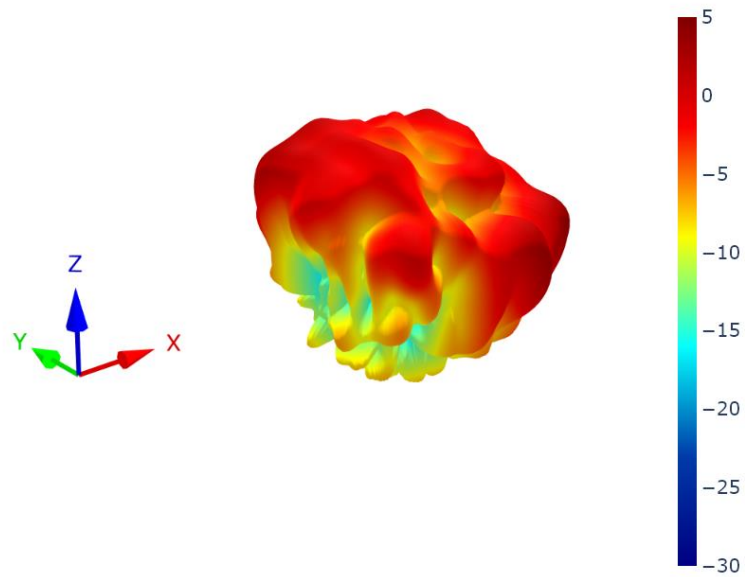

8.54 5G/4G-3 Patterns at 5530 MHz

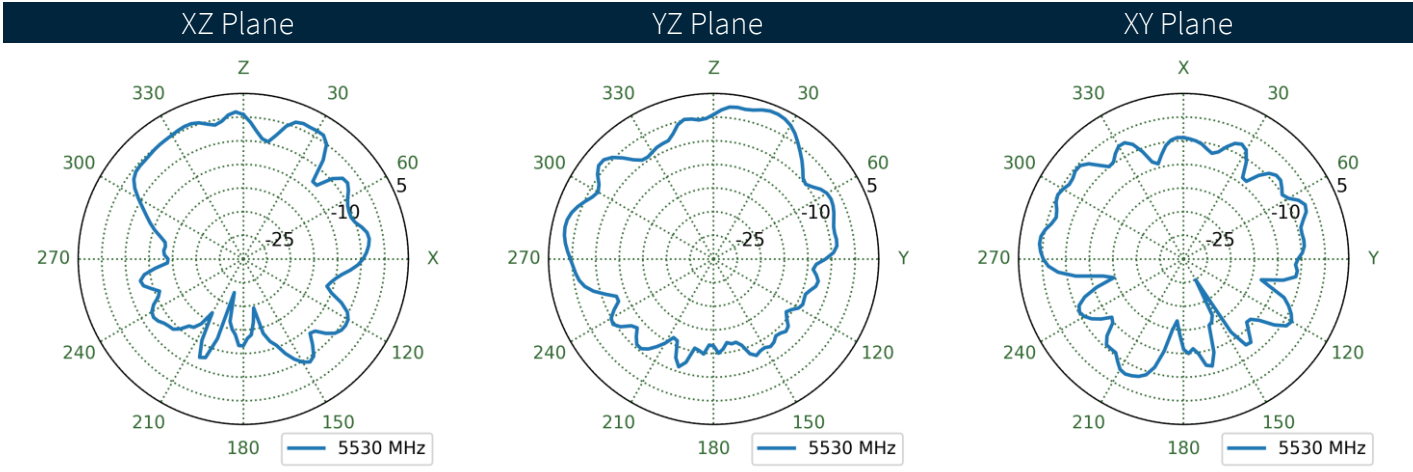
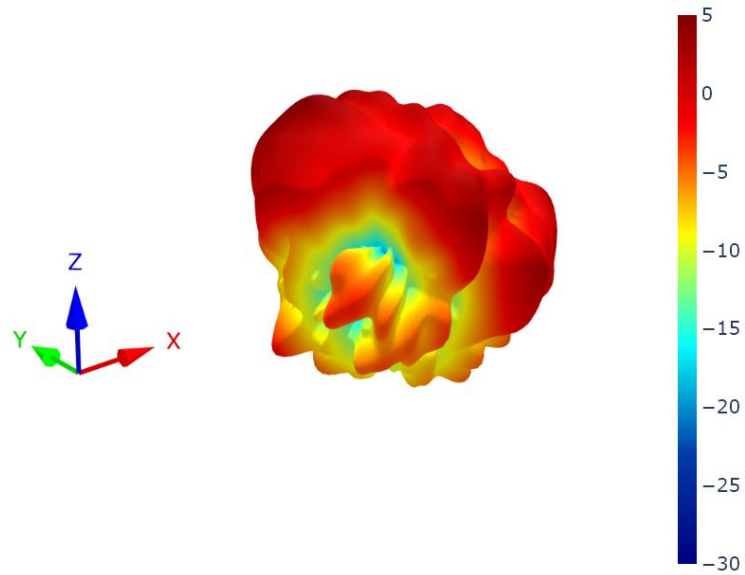

8.55 5G/4G-4 Patterns at 5530 MHz

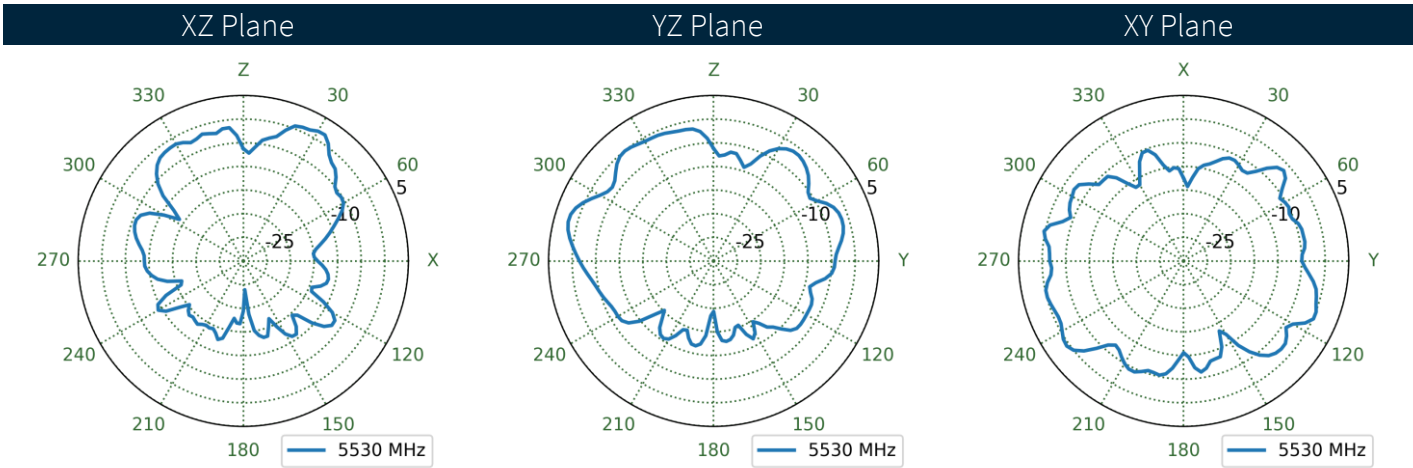
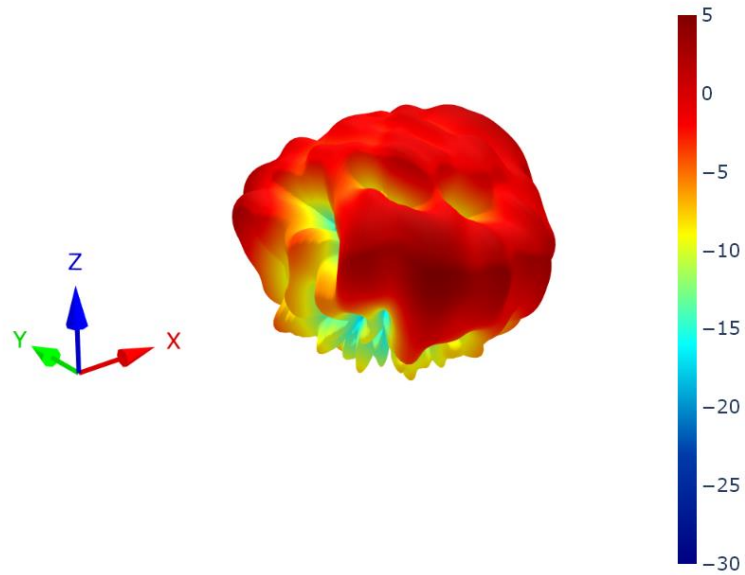

Changelog for the datasheet

SPE-24-8-089 - MA8005.A.001

Revision: B (Current Version)	
Date:	2025-01-13
Notes:	Updated reference to IK10 rating, product descriptions, reference of PC material on the enclosure, IK69 rating and certification logos.
Author:	Conor McGrath

Previous Revisions

Revision: A (Original First Release)	
Date:	2024-05-02
Notes:	Initial Release
Author:	Gary West



www.taoglas.com



X-ON Electronics

Largest Supplier of Electrical and Electronic Components

Click to view similar products for [Antennas](#) category:

Click to view products by [Taoglas](#) manufacturer:

Other Similar products are found below :

[930-033-R](#) [EXE902SM](#) [108-00014-50](#) [66089-2406](#) [A09-F8NF-M](#) [A09-F5NF-M](#) [RGFRA1903041A1T](#) [W1049B090](#) [TRABT1560](#)
[WTL2449CQ1-FRSMM](#) [CPL9C](#) [CB27S](#) [0600-00060](#) [Y4503](#) [PAL90209H-FNF](#) [GD53-25](#) [MAF94051](#) [S9025PLSMF](#) [QWFTB120](#)
[MAF94300](#) [FG4403](#) [BB1442NR](#) [GPSCPMM00](#) [ANTDOM-05-01-WPM](#) [ANT-WP868SMA-Y](#) [EXW30BNX](#) [S4908WBFNM](#) [B4305CN](#)
[C27](#) [C27S](#) [CBNC58](#) [EXH160MXI](#) [EXH160SFK](#) [EXC902SM](#) [CB27](#) [ABFT](#) [BB4502NR](#) [B4502N](#) [S4908WBFNF](#) [NMOQ88C](#) [NMOQB](#)
[NMOQC](#) [ANT-GSMGPSPUKS](#) [60210](#) [60140](#) [ANT-8WPIG-UFL](#) [ANT-GPSPUKS](#) [A21H0](#) [29000863](#) [29000848](#)