



TAOGLAS®



Datasheet

Part No:
DSGP182B

Description

GPS L1/GALILEO E1 / BEIDOU B1C 1575.42MHz SMD Ceramic Patch Antenna

Features:

SMD Mount Ceramic Patch Antenna
GPS L1 / GALILEO E1 / BEIDOU B1C 1575.42MHz
Includes Additional Solder Mask
Dimension: 18 x 18 x 2mm
RoHS & Reach Compliant

1.	Introduction	3
2.	Specification	4
3.	Mechanical Drawing	6
4.	Packaging	7
5.	Antenna Integration Guide	8
6.	Antenna Characteristics	15
7.	Radiation Patterns	19
8.	Solder Reflow Profile	21
<hr/>		
	Changelog	22

Taoglas makes no warranties based on the accuracy or completeness of the contents of this document and reserves the right to make changes to specifications and product descriptions at any time without notice. Taoglas reserves all rights to this document and the information contained herein. Reproduction, use or disclosure to third parties without express permission is strictly prohibited.

Ireland & USA
ISO 9001:2015
Certified



Taiwan
ISO 9001:2015
Certified



1. Introduction



The DSGP182B is a compact ceramic GPS L1 / GALILEO E1 / BEIDOU B1C 1575.42 MHz passive patch antenna, measuring just 18mm x 18mm with a low-profile height of 2mm. Its small form factor makes it ideal for space-constrained applications such as compact telematics devices, vehicle tracking and fleet management systems, wearables, and navigation devices.

The antenna is optimized for a 50mm x 50mm ground plane, operating at 1575.42 MHz with a peak gain of -0.17dBi. Designed for SMT mounting, the ceramic patch includes an additional solder mask to enhance durability and prevent cracking due to heat expansion during high-volume, cost-sensitive assembly processes.

Typical applications include:

- Vehicle Tracking and Fleet Management Systems
- Wearables
- Navigation Devices

The DSGP Series can be manufactured in a TS16949 first-tier automotive-approved facility and tested to AEC-Q200 certification if required. Further to this, full PPAP and IMDS documentation can be provided upon request. Please discuss your quality and reliability requirements with our team prior to ordering.

Taoglas also offers custom tuning services based on minimum order quantities, contact your regional Taoglas customer support team for further information.

2. Specification

GNSS Frequency Bands					
GPS	L1 1575.42 MHz	L2 1227.6 MHz	L5 1176.45 MHz		
	■	□	□		
GLONASS	G1 1602 MHz	G2 1248 MHz	G3 1207 MHz		
	□	□	□		
Galileo	E1 1575.24 MHz	E5a 1176.45 MHz	E5b 1201.5 MHz	E6 1278.75 MHz	
	■	□	□	□	
BeiDou	B1C 1575.42 MHz	B1I 1561 MHz	B2a 1176.45 MHz	B2b 1207.14 MHz	B3 1268.52 MHz
	■	□	□	□	□
L-Band	L-Band 1542 MHz				
	□				
QZSS (Regional)	L1 1575.42 MHz	L2C 1227.6 MHz	L5 1176.45 MHz	L6 1278.75e6	
	■	□	□	□	
IRNSS (Regional)	L5 1176.45 MHz				
	□				
SBAS	L1/E1/B1 1575.42 MHz	L5/B2a/E5a 1176.45 MHz	G1 1602 MHz	G2 1248 MHz	G3 1207 MHz
	■	□	□	□	□

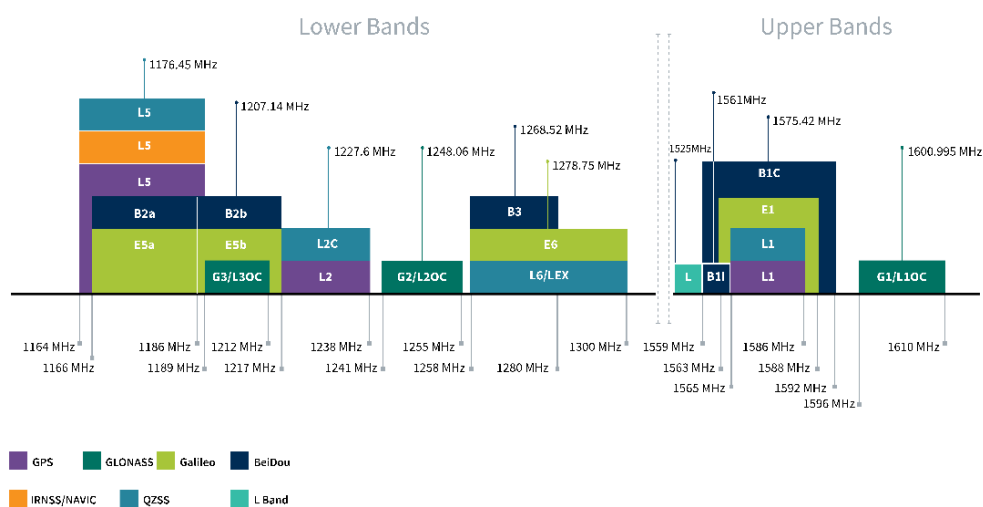

GNSS Bands and Constellations

GNSS Electrical	
Frequency (MHz)	L1 - 1575.42
	1565-1586
Efficiency (%)	27.2
Average Gain (dB)	-5.65
Peak Gain (dBi)	-0.17
Axial Ratio (dB)	6.50
Polarization	RHCP
Impedance	50 Ω
*Antenna tested on 50x50mm Ground Plane	

Mechanical	
Dimensions	18mm x 18mm x 2 mm
Weight	1.8g \pm 3%
Material	Ceramic

Environmental	
Operation Temperature	-40°C to 105°C
Storage Temperature	-40°C to 105°C
Relative Humidity	Non-condensing 65°C 95% RH
Moisture Sensitivity	3 (168 Hours)

3. Mechanical Drawing

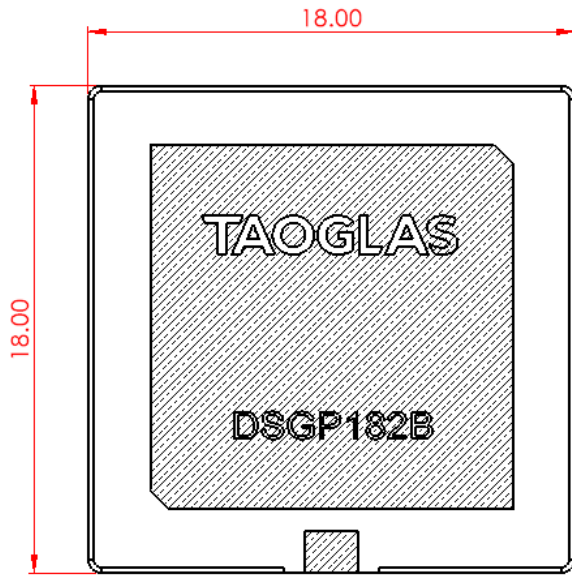

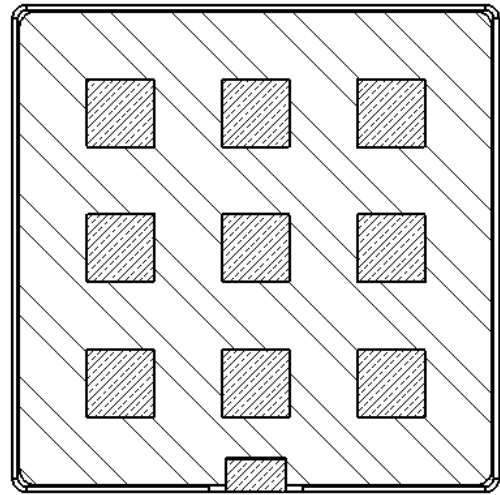

TOP

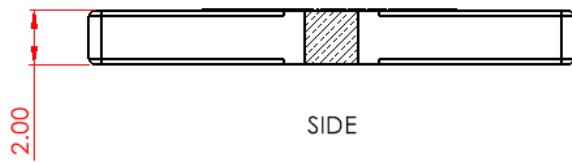

BOTTOM



SIDE

-  SILVER
-  CERAMIC
-  SOLDER MASK

4. Packaging

200 pcs/ Reel/ Vacuum bag



200 pcs / Box
 Box: 350x340x67mm
 Weight: 1.3 ±3% Kg

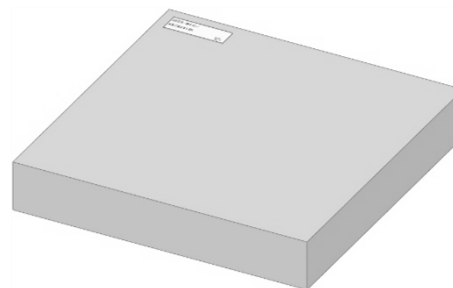

800 pcs / Carton
 Carton: 370x370x300mm
 Weight: 6 ±3% Kg



5. Antenna Integration Guide

The following is an example on how to integrate the DSGP182B into a design. This antenna has 10 pins, where one pin is used for the RF Feed. Taoglas recommends using a minimum of 50x50mm ground plane (PCB) to ensure optimal performance.

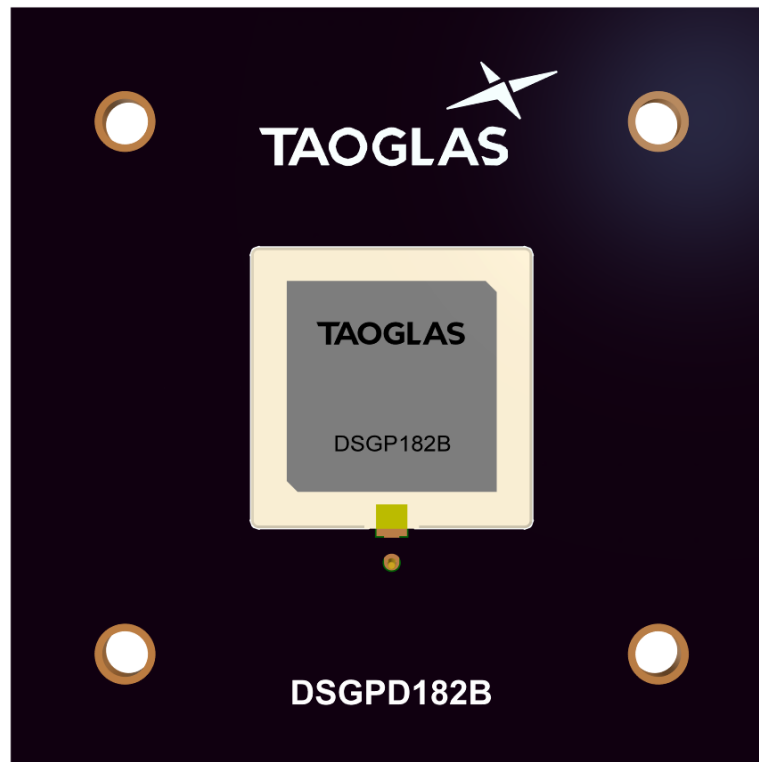

Top view of PCB reference design.

5.1 Schematic and Symbol Definition

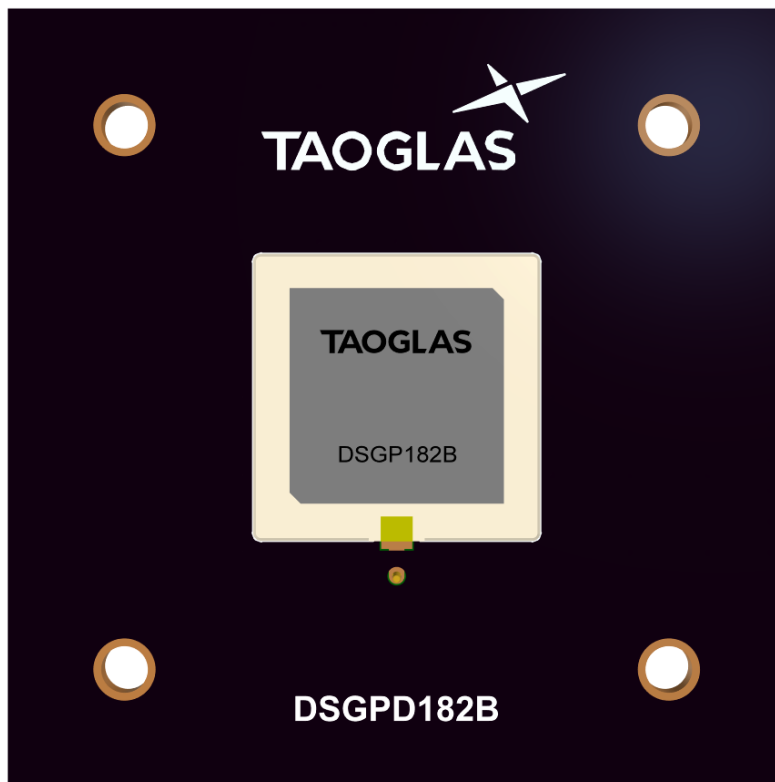

Above is a 3D model of the DSGP182B on a PCB reference design.

The circuit symbol for the DSGP182B is shown below. The antenna has 10 pins as indicated below.

Pin	Description
1	RF Feed
2-10	Ground

TAOGLAS_DSGP182B
ANTI

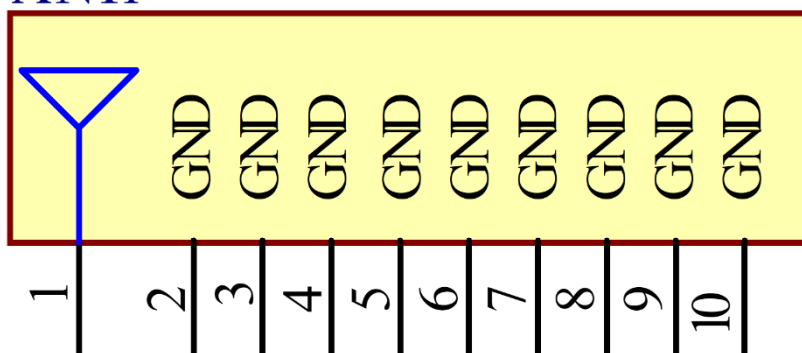

5.2 Antenna Footprint

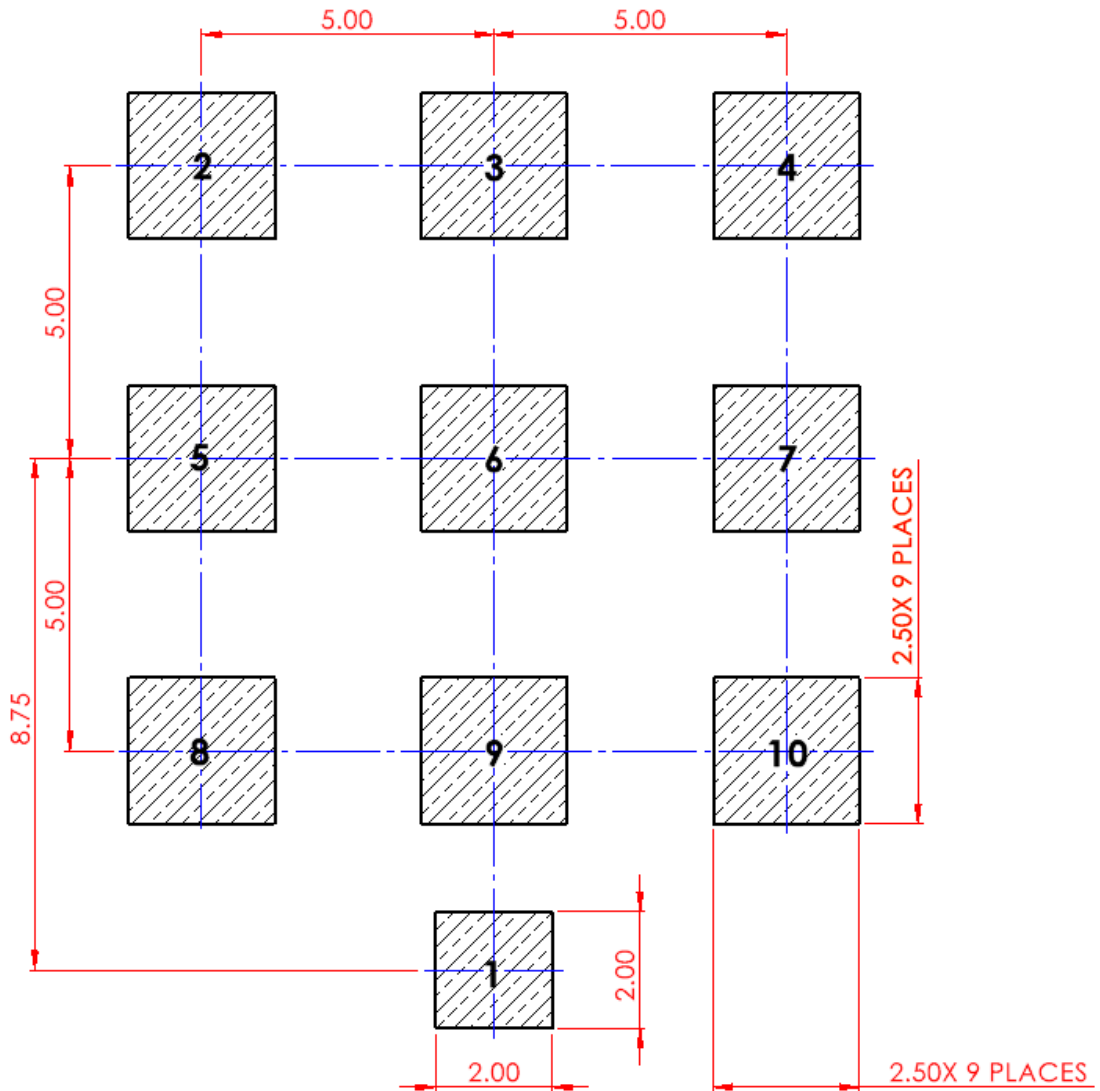

Pin	Description
1	RF Feed
2-10	Ground

5.3 Top Solder Paste

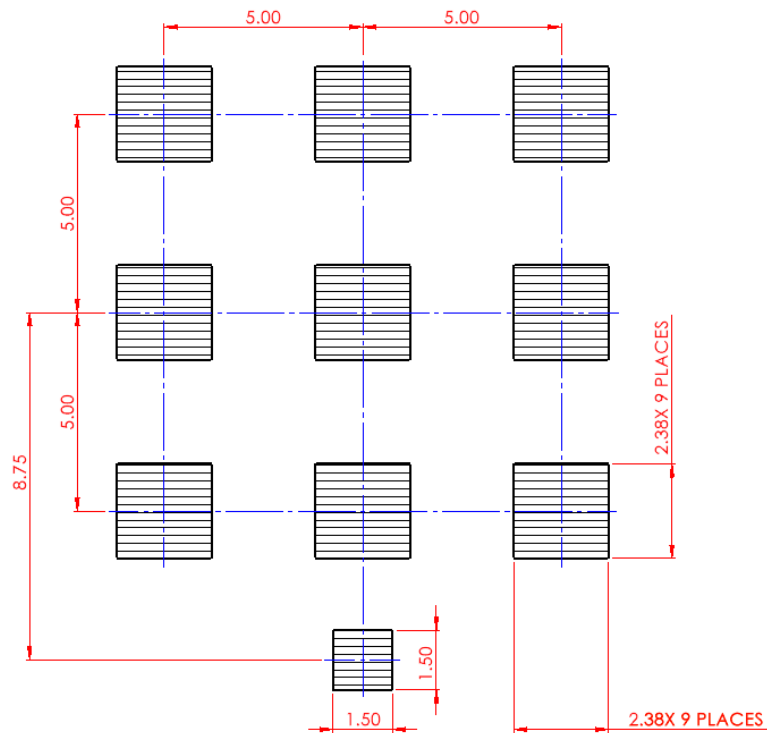

5.4 Top Solder Mask

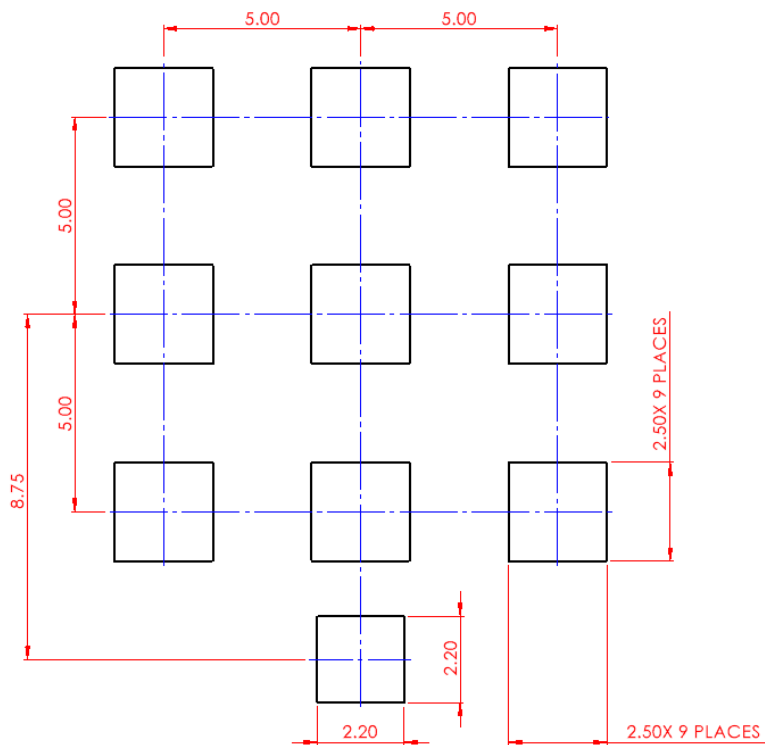

5.5 Copper Clearance for DSGP182B

The footprint and clearance on the PCB must comply with the antenna's specification. The PCB layout shown in the diagrams below demonstrates the DSGP182B clearance area. The copper keep out area applies to the top layer and all internal layers.

There should be a 3mm copper clearance area around RF Feed pad.

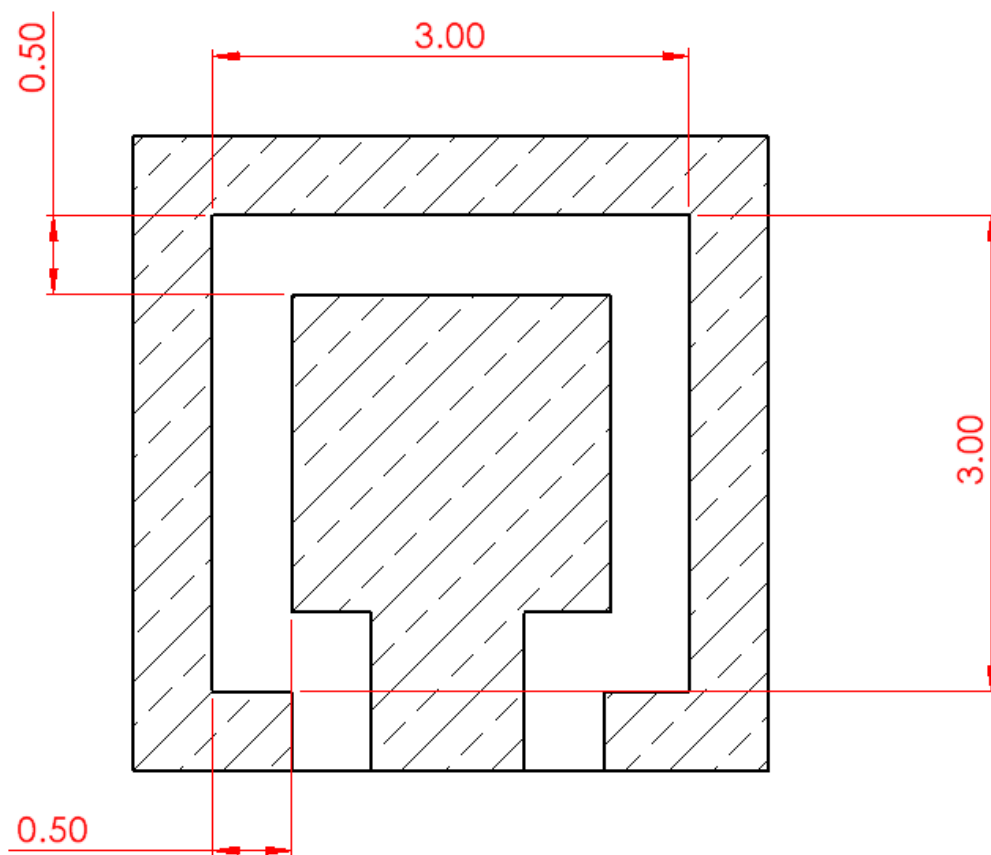

5.6 Antenna Integration

The DSGP182B should be placed at the centre of the PCB, to take advantage of the ground plane. The RF trace must maintain a 50 Ohm transmission line. Ground vias should be placed around the RF trace.

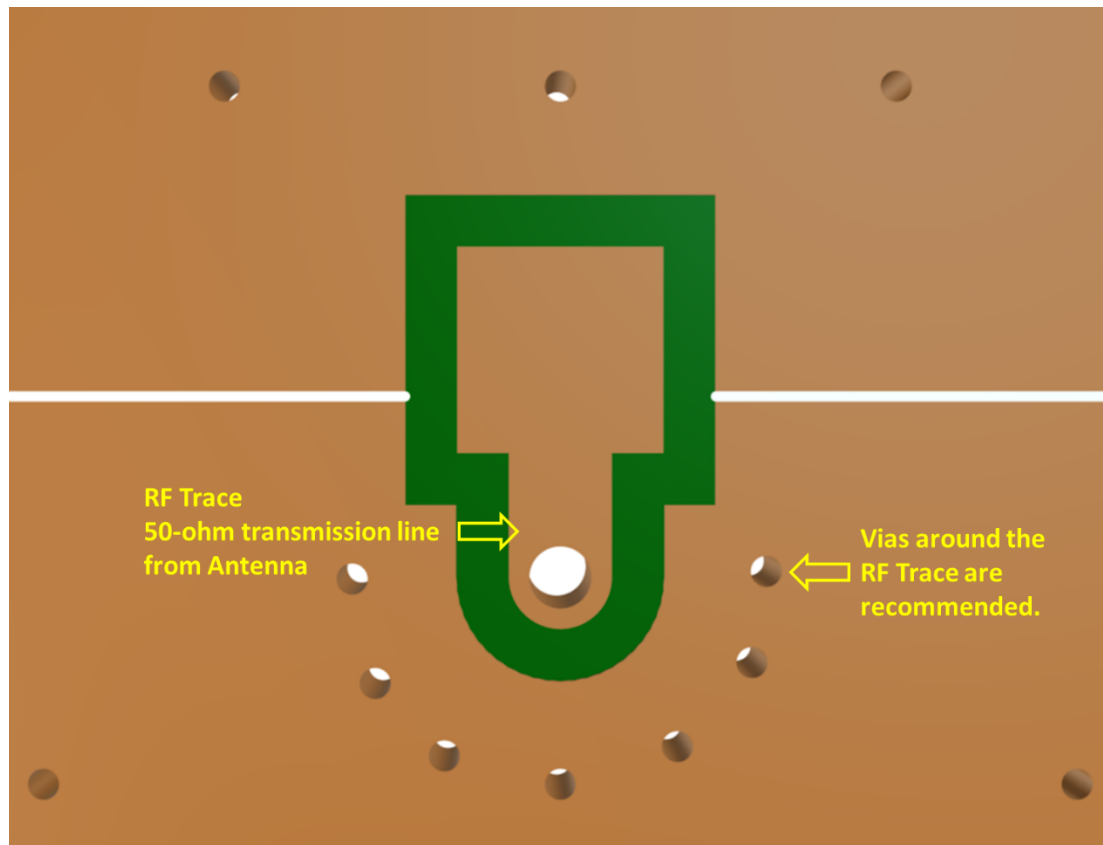

DSGP182B antenna mounted on a PCB reference design, showing transmission lines and integration notes.

5.7 Final Integration

The top side image shown below highlights the antenna transmission line. Taoglas recommends using a minimum of 50x50mm ground plane (PCB) to ensure optimal performance.



Top Side (DSGP182B placement on 50x50mm PCB reference design)

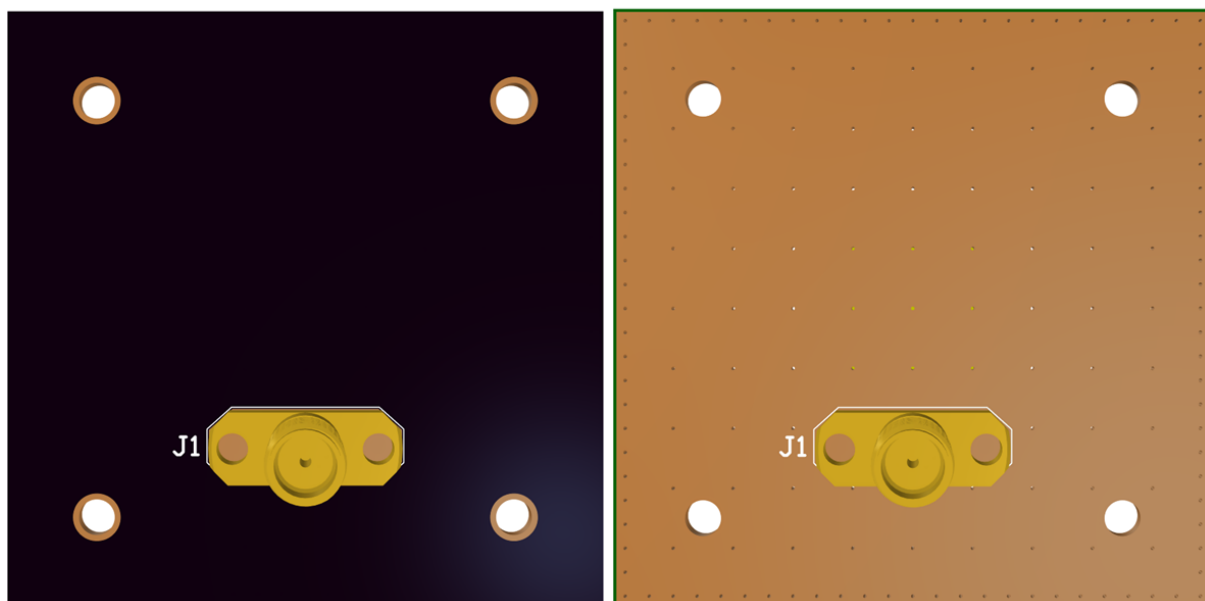

Bottom Side

6. Antenna Characteristics

6.1 Test Setup

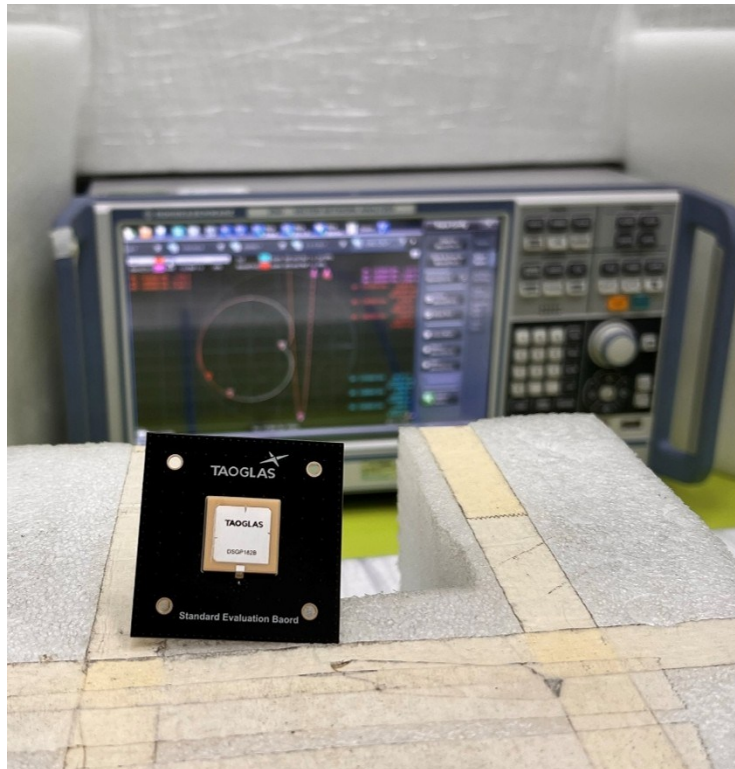
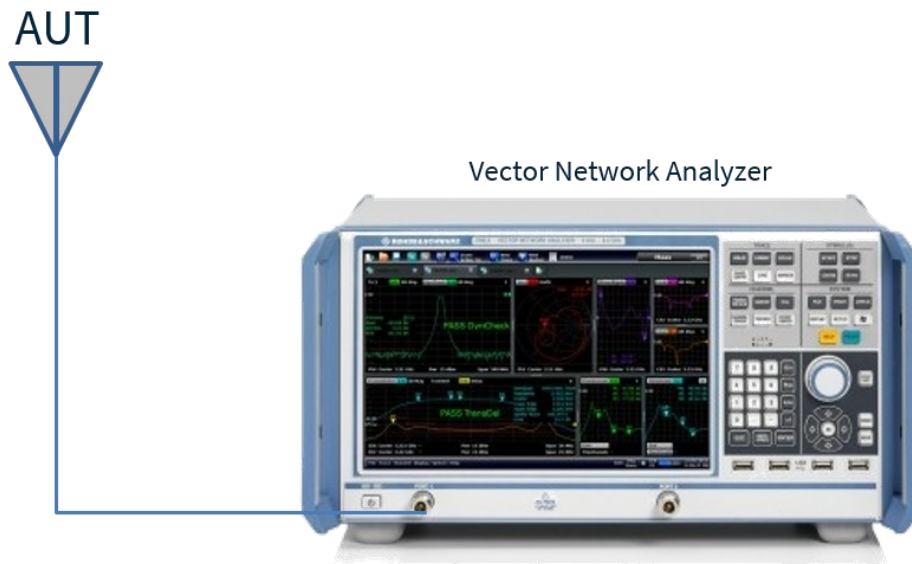

VNA Test Set-up

6.2 Return Loss

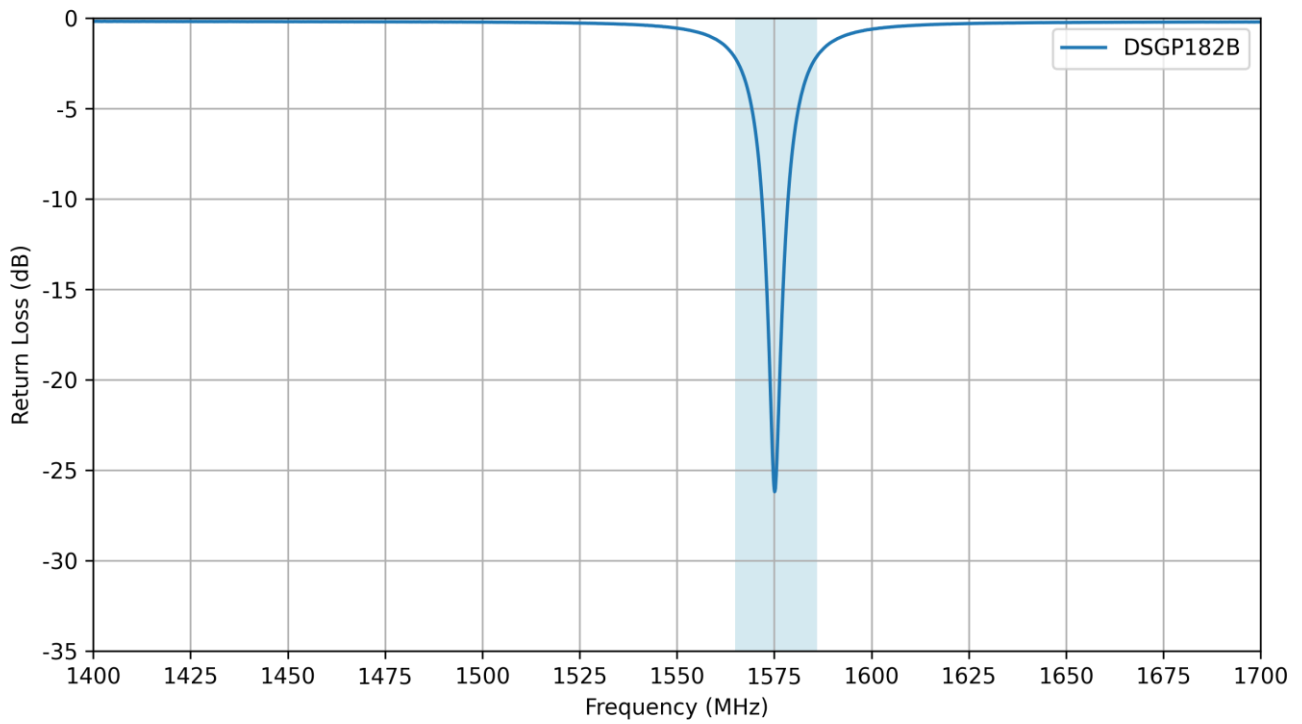

6.3 VSWR

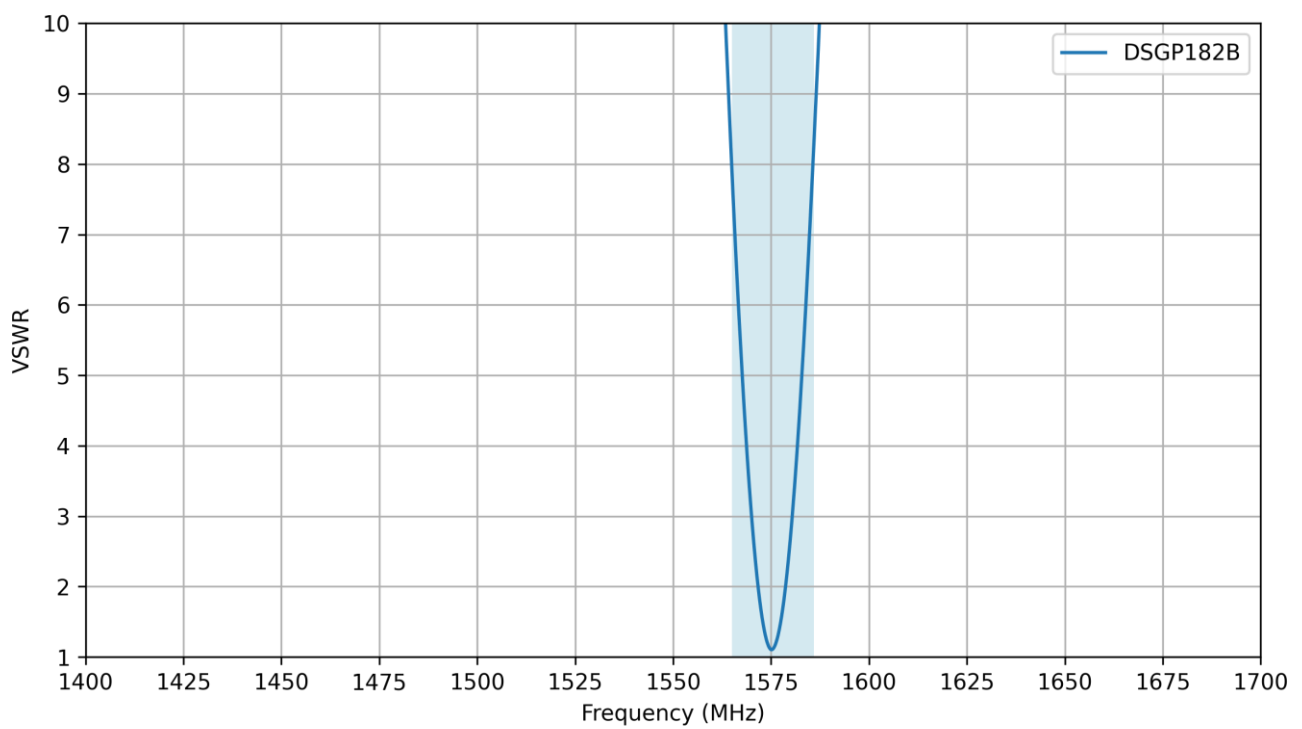

6.4 Efficiency

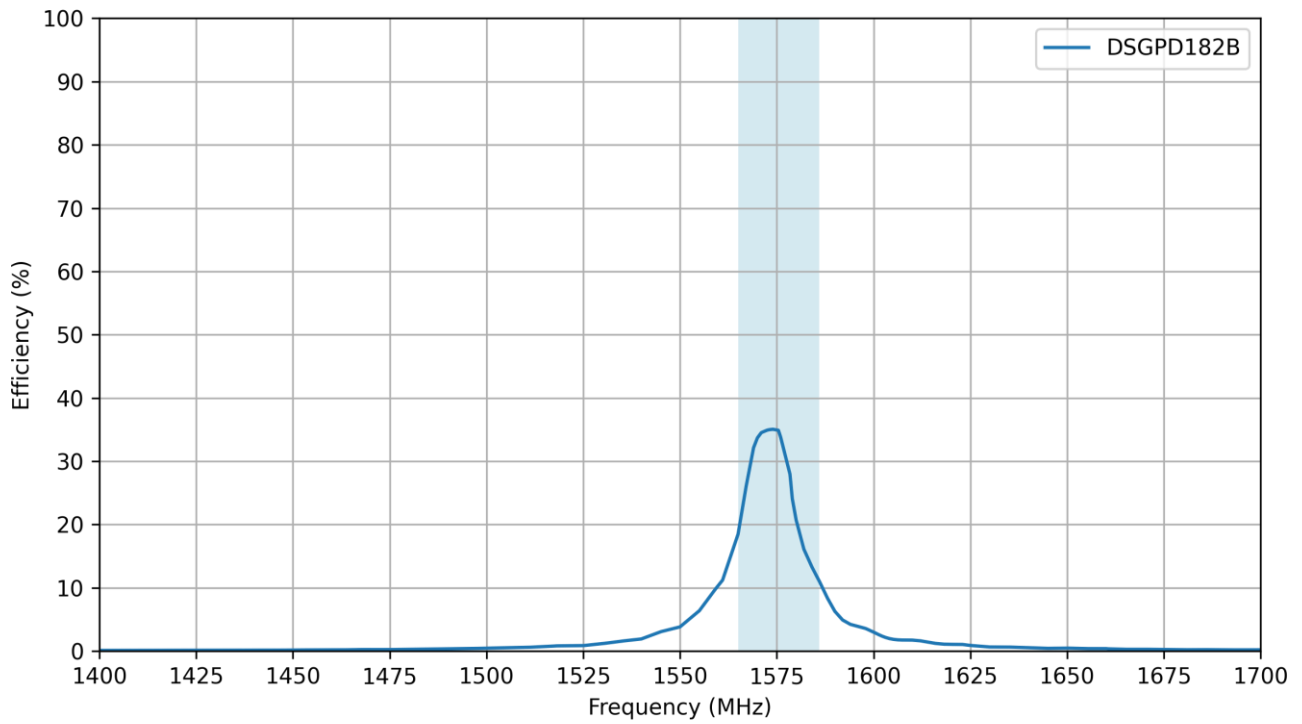

6.5 Average Gain

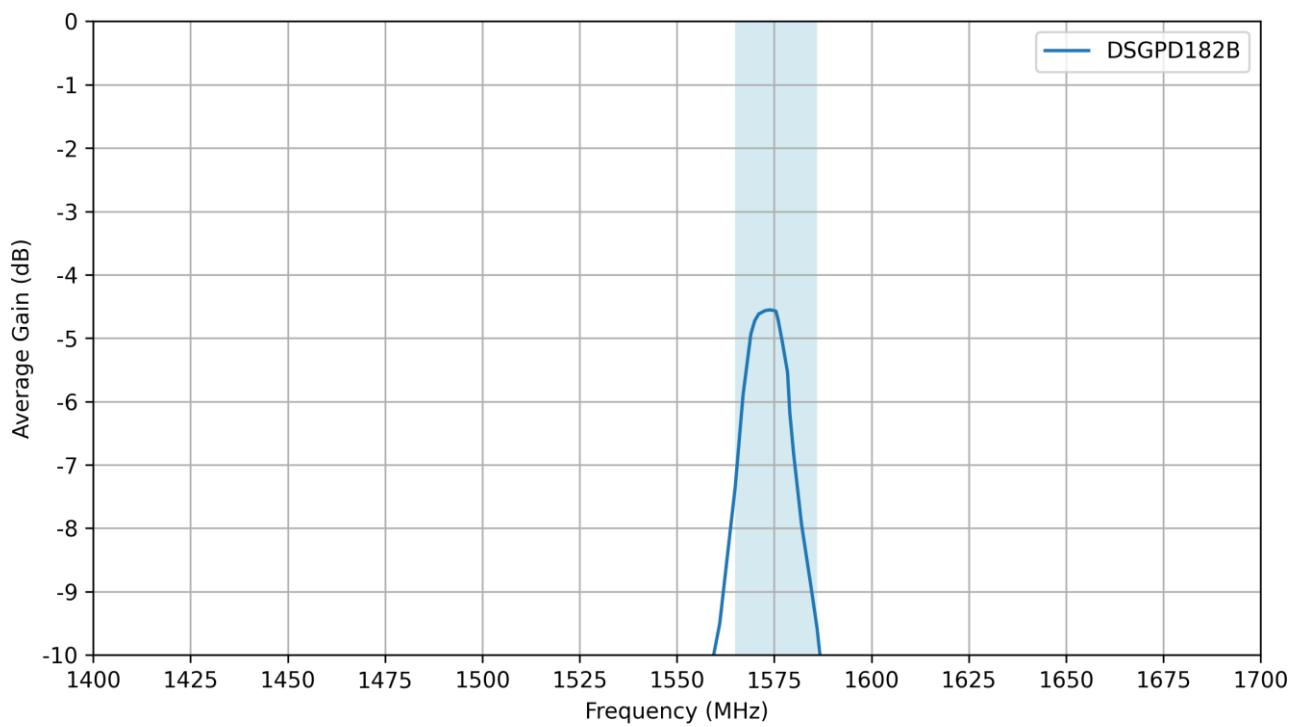

6.6 Peak Gain

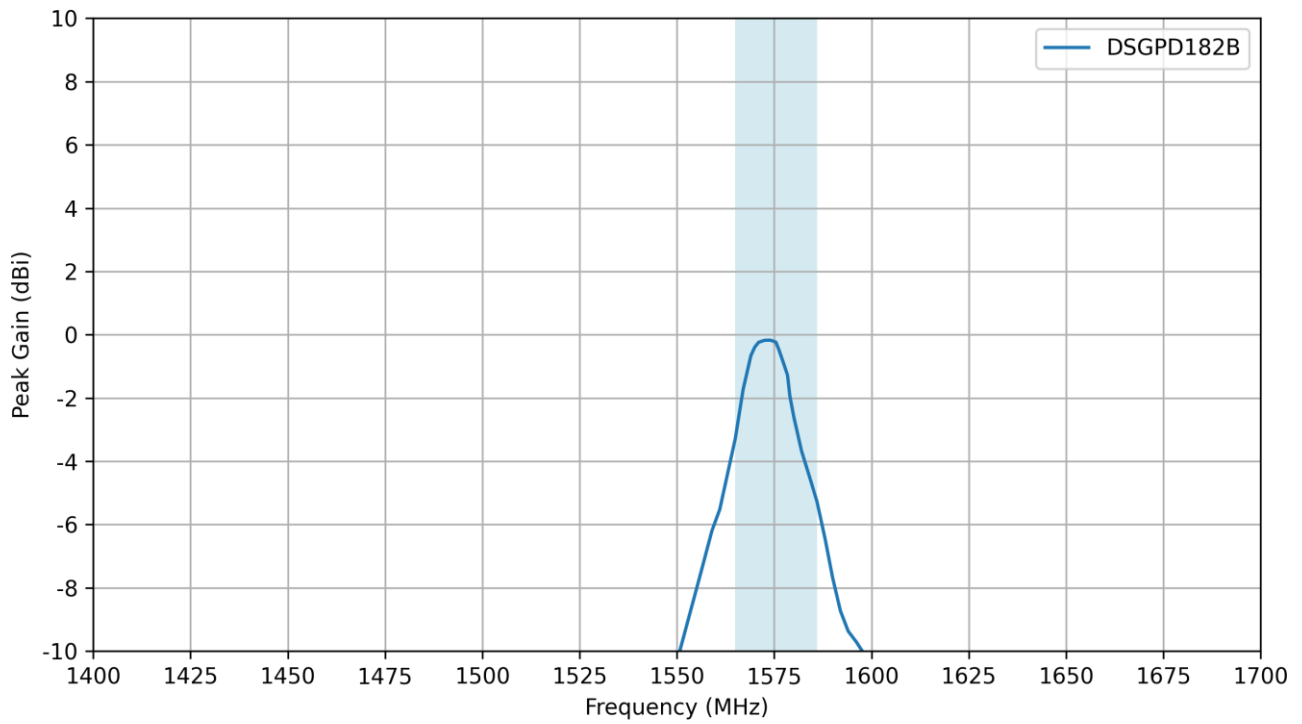

6.7 Axial Ratio

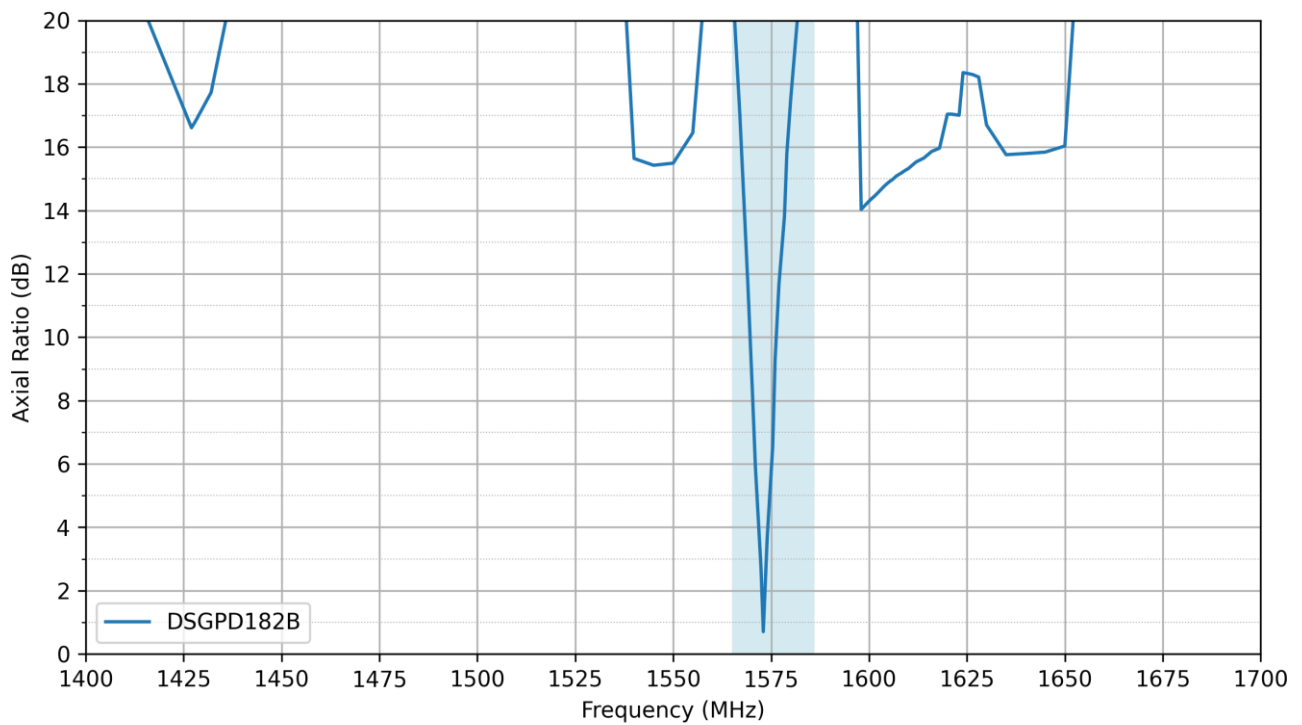

7. Radiation Patterns

7.1 Test Setup

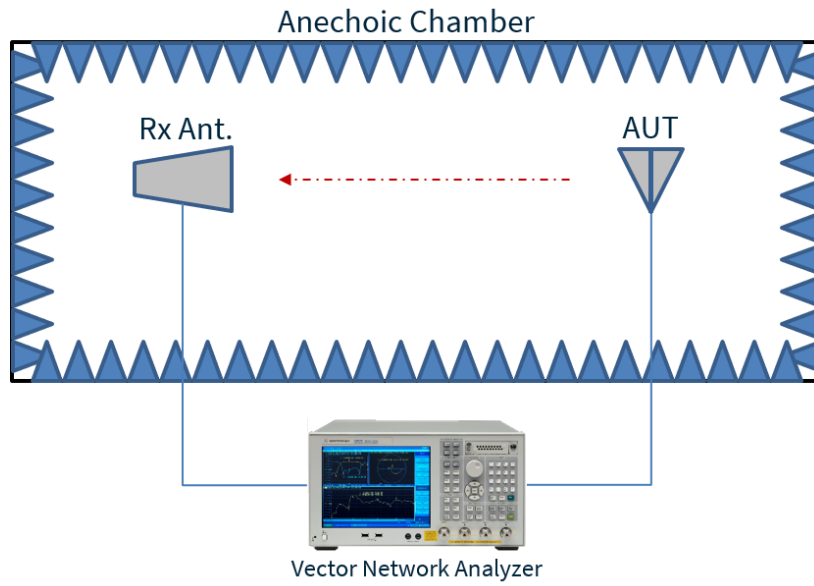

Chamber Test Set-up

7.2 Patterns at 1575 MHz

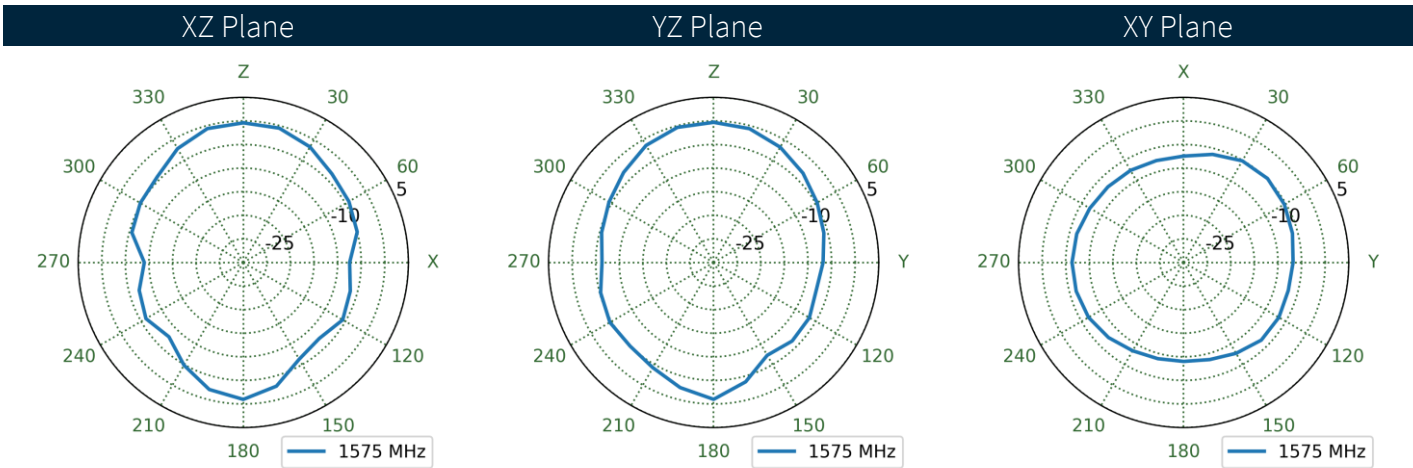
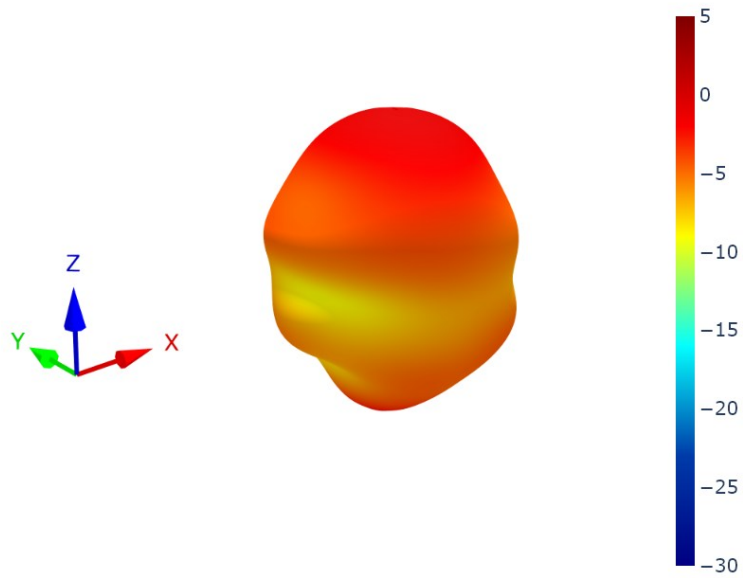

8. Solder Reflow Profile

The DSGP182B can be assembled by following the recommended soldering temperatures are as follows:

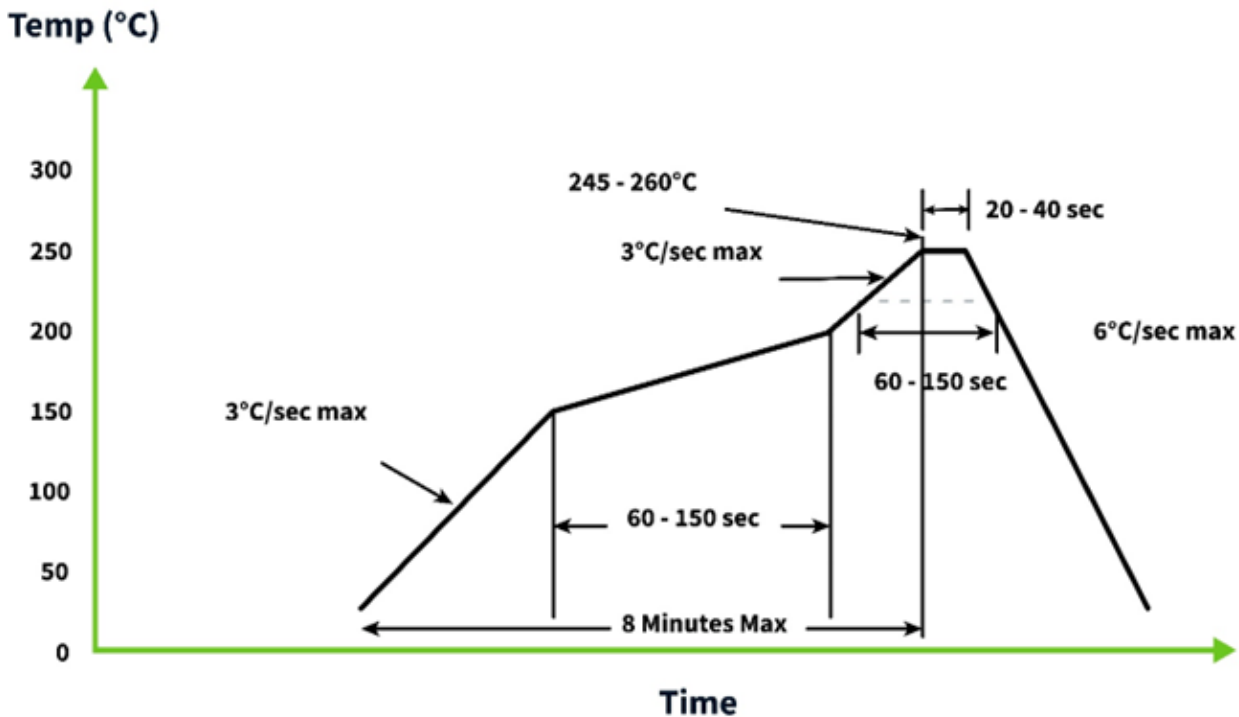

*Temperatures listed within a tolerance of +/- 10° C

Smaller components are typically mounted on the first pass, however, we do advise mounting the DSGP182B when placing larger components on the board during subsequent reflows.

Note: Soldering flux classified ROL0 under IPC J-STD-004 is recommended.

Changelog for the datasheet

SPE-25-8-113 – DSGP182B

Revision: A (Original First Release)

Date:	2025-04-04
Notes:	Initial Release
Author:	Gary West



www.taoglas.com



X-ON Electronics

Largest Supplier of Electrical and Electronic Components

Click to view similar products for [Antennas](#) category:

Click to view products by [Taoglas](#) manufacturer:

Other Similar products are found below :

[930-033-R](#) [EXE902SM](#) [108-00014-50](#) [66089-2406](#) [A09-F8NF-M](#) [A09-F5NF-M](#) [RGFRA1903041A1T](#) [W1049B090](#) [TRABT1560](#)
[WTL2449CQ1-FRSMM](#) [CPL9C](#) [CB27S](#) [0600-00060](#) [Y4503](#) [PAL90209H-FNF](#) [GD53-25](#) [MAF94051](#) [S9025PLSMF](#) [QWFTB120](#)
[MAF94300](#) [FG4403](#) [BB1442NR](#) [GPSCPMM00](#) [ANTDOM-05-01-WPM](#) [ANT-WP868SMA-Y](#) [EXW30BNX](#) [S4908WBFNM](#) [B4305CN](#)
[C27](#) [C27S](#) [CBNC58](#) [EXH160MXI](#) [EXH160SFK](#) [EXC902SM](#) [CB27](#) [ABFT](#) [BB4502NR](#) [B4502N](#) [S4908WBFNF](#) [NMOQ88C](#) [NMOQB](#)
[NMOQC](#) [ANT-GSMGPSPUKS](#) [60210](#) [60140](#) [ANT-8WPIG-UFL](#) [ANT-GPSPUKS](#) [A21H0](#) [29000863](#) [29000848](#)