

Tajima

2023



Since 1909

Tajima 2023 LINE UP

LAYOUT TOOLS
Pg. 80-82

LED-LIGHTS
Pg. 40-45

DRYWALL TOOLS
Pg. 47-52

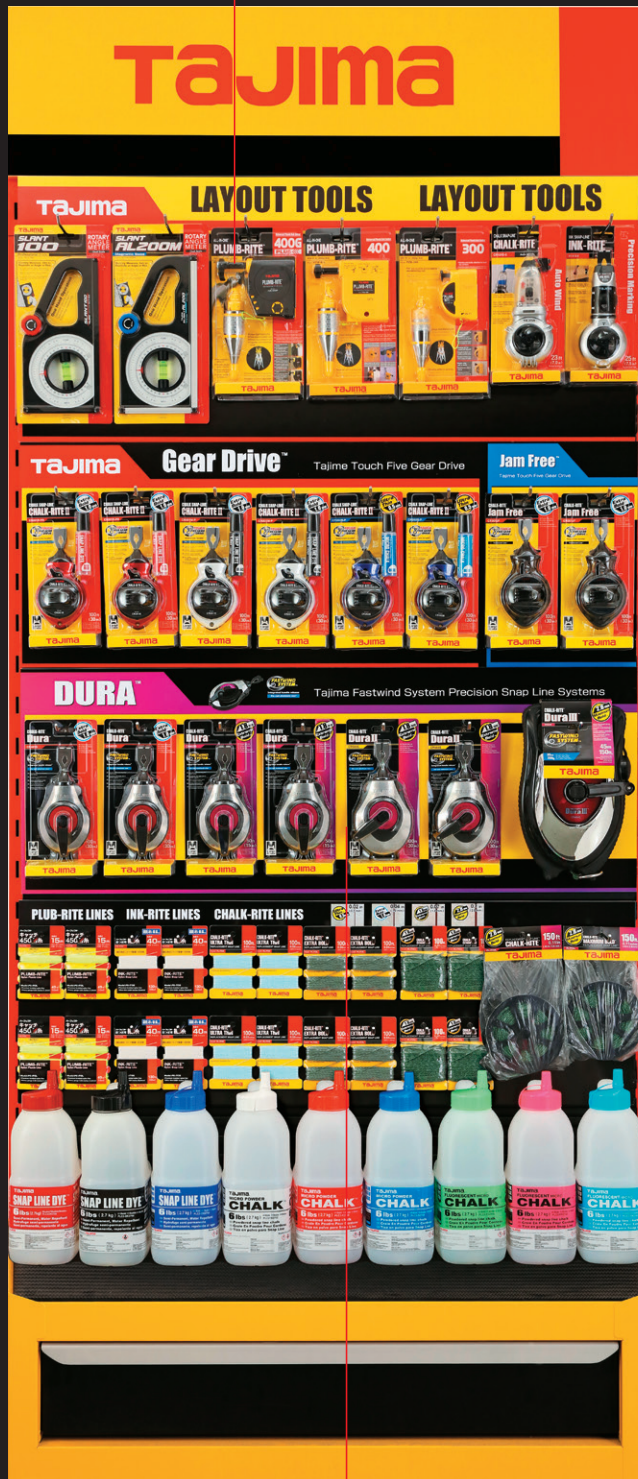

MARKING TOOLS
Pg. 10-18



UTILITY KNIVES & BLADES
Pg. 54-67

MEASURING TAPES
Pg. 28-38

CAULK GUNS
Pg. 20-26

Tajima

Tajima



SCRAPERS
Pg. 68

PULL-STROKE SAWS
Pg. 70-78

Ideal Retail Display



Tajima



H : 89.7 in
(228 cm)

W : 41.3 in
(105 cm)

D : 16.5 in
(42 cm)

TAJIMA POP DISPLAY

BACKER BOARD



H : 15.1 in
(38.5 cm)

W : 31.5 in (80 cm)

ITEM CODE : BBP-CR-04



H : 7.5 in
(19 cm)

W : 39.4 in (100 cm)

ITEM CODE : BBP-MT-03



H : 7.5 in
(19 cm)

W : 41.3 in (105 cm)

ITEM CODE : BBP-MT-02



H : 7.5 in
(19 cm)

W : 41.3 in (105 cm)

ITEM CODE : BBP-MT-01



H : 9.8 in
(25 cm)

W : 17.7 in (45 cm)

ITEM CODE : BBP-LE-01



H : 15 in
(39 cm)

W : 27 in (68 cm)

ITEM CODE : BBP-PK-03



H : 12.2 in
(31 cm)

W : 39.4 in (100 cm)



H : 13.8 in
(35 cm)

W : 39.4 in (100 cm)

TAJIMA TOP BOARD



H : 6.3 in
(16 cm)

W : 23.6 in (60 cm)

TAJIMA POP DISPLAY

STICKERS & HOOKS



ITEM CODE : CNVHOOK



ITEM CODE : CNVHOOK2



ITEM CODE (From the left):
 1st stage CNVST-RS, CNVST-SP26, CNVST-SP18, CNVST-SP, CNVST-PL2, CNVST-LT
 2nd stage CNVST-RS/J, CNVST-SP26/J, CNVST-SP18/J, CNVST-SP/J, CNVST-PL2/J

DISPLAY



H : 32.3 in
(82 cm)

D : 13.8 in
(35 cm)













D : 13.8 in
(35 cm)

MARKING TOOLS



MARKING TOOLS



LINE THICKNESS	0.02 in (0.5 mm) Ultra Thin™ 0.5mm	0.04 in (1.0 mm) Extra Bold™ 1.0mm	0.07 in (1.8 mm) 1.8mm Extreme Bold™	0.1 in (2.8 mm) 2.8mm Maximum Bold™
LINE LENGTH				
150 ft (45 m)				CR604S Pg. 11 
100 ft (30 m)	CR202B-P Pg. 13 	CR301JF Pg. 13  CR201R-PR/W-P Pg. 12  CR401S Pg. 12 	CR503S Pg. 11 	
50 ft (15 m)			CR403S Pg. 11 	
23 ft (7 m)		CR101S-0 Pg. 14 		
REPLACEMENT SNAP LINE	PL-ITOS Pg. 14 	PL-ITOL Pg. 14 	PL-ITOLL Pg. 14 	PL-ITO3L Pg. 14 

MARKING TOOLS

CHALK-RITE® DURA III



- Specially crafted woven snap line creates Maximum Bold 0.1 in (2.8 mm) lines
- Holds up to 25 oz (709 g) chalk
- Large, leak-proof refill port
- Ergonomically designed shock-resistant case with a heavy-duty aluminum front plate
- Double-speed winding mechanism



ITEM CODE	LINE LENGTH		CASE	MASTER CARTON	UPC
CR604S	0.1 in (2.8 mm) x 150 ft (45 m)	FASTWIND SYSTEM	1	12	0-49296-05830-2

CHALK-RITE® DURA / DURA II

(CR403S)

(CR503S)



CR403S



CR503S

- Premium braided snap line creates Extreme Bold 0.07 in (1.8 mm) lines
- Holds 2x more chalk than the Extra Bold Snap Line marking tools
- Heavy-duty aluminum case integrated with non-slip grip surface
- Large refill port also allows for convenient felt replacement
- Double-speed winding mechanism



ITEM CODE	LINE LENGTH		CASE	MASTER CARTON	UPC
CR403S	0.07 in (1.8 mm) x 50 ft (15 m)	FASTWIND SYSTEM	4	24 (6 sets)	0-49296-05774-9
CR503S	0.07 in (1.8 mm) x 100 ft (30 m)	FASTWIND SYSTEM			0-49296-05775-6

MARKING TOOLS

CHALK-RITE® DURA



- Premium braided line creates an Extra Bold 0.04 in (1.0 mm) line
- Heavy-duty aluminum case integrated with non-slip grip surface
- Large gasket-sealed refill port
- Double-speed winding mechanism



Integrated handle release™
Die-cast aluminum Case™



ITEM CODE	LINE LENGTH		CASE	MASTER CARTON	UPC
CR401S	0.04 in (1.0 mm) x 100 ft (30 m)	FASTWIND SYSTEM	4	24 (6 sets)	0-49296-05740-4

CHALK-RITE® II EXTRA BOLD



CR201R-PR



CR201W-P

- Premium braided line creates Extra Bold 0.04 in (1.0 mm) lines
- Large gasket-sealed refill port
- Heavy-duty aluminum case
- Smooth-running five-gear winding mechanism



Smooth and durable™
Die-cast aluminum Case™



ITEM CODE	LINE LENGTH		CASE	MASTER CARTON	UPC
CR201R-PR	0.04 in (1.0 mm) x 100 ft (30 m)	TOUGH FIVE GEAR DRIVE	4	24 (6 sets)	0-49296-05621-6
CR201W-P					0-49296-05678-0

MARKING TOOLS

CHALK-RITE® JAM FREE



- Jam-free braided line creates Extra Bold 0.04 in (1.0 mm) lines
- Durable ABS case with large refill port
- Smooth-running five-gear winding mechanism



ITEM CODE	LINE LENGTH		CASE	MASTER CARTON	UPC
CR301JF	0.04 in (1.0 mm) x 100 ft (30 m)	TOUCH FIVE GEAR DRIVE	8	32 (4 sets)	0-49296-05647-6

CHALK-RITE® II ULTRA-THIN



- Specially crafted braided line creates Ultra-Thin 0.02 in (0.5 mm) lines
- Large gasket-sealed refill port
- Heavy-duty aluminum case
- Smooth-running five-gear winding mechanism



ITEM CODE	LINE LENGTH		CASE	MASTER CARTON	UPC
CR202B-P	0.02 in (0.5 mm) x 100 ft (30 m)	TOUCH FIVE GEAR DRIVE	4	24 (6 sets)	0-49296-05593-6

MARKING TOOLS

CHALK-RITE® AUTO WIND



- Premium braided snap line creates Extra Bold 0.04 in (1.0 mm) lines
- Automatic winding mechanism
- Unique see-through cannister and chalk metering sleeve



quick-view canister
chalk metering sleeve
mixing ball



ITEM CODE	LINE LENGTH		CASE	MASTER CARTON	UPC
CR101S-0	0.04 in (1.0 mm) x 23 ft (7 m)	AUTO WIND	6	36 (6 sets)	0-49296-05484-7

CHALK-RITE® REPLACEMENT LINE

- Premium braided nylon line for Chalk-Rite marking tools























MAXIMUM BOLD	0.1 in	
EXTREME BOLD	0.07 in	
EXTRA BOLD	0.04 in	
ULTRA-THIN	0.02 in	



ITEM CODE	LINE LENGTH		CASE	MASTER CARTON	UPC
PL-IT03L	0.1 in (2.8 mm) x 150 ft (45 m)	MAXIMUM BOLD	1	20	0-49296-05835-7
PL-IT0LL	0.07 in (1.8 mm) x 100 ft (30 m)	EXTREME BOLD	10	100	0-49296-05782-4
PL-IT0L	0.04 in (1.0 mm) x 100 ft (30 m)	EXTRA BOLD			0-49296-05435-9
PL-IT0S	0.02 in (0.5 mm) x 100 ft (30 m)	ULTRA-THIN			0-49296-05434-2

MARKING TOOLS

CHALK LINE REPLACEMENT PARTS COMPATIBILITY TABLE

CHALK LINE		 CR503S Pg. 11	 CR403S Pg. 11	 CR401S Pg. 12	 CR301JF Pg. 13	 CR202B-P Pg. 13	 CR201R-PR Pg. 12	 CR201W-P Pg. 12
REPLACEMENT PARTS								
TAJ-EH09								
TAJ-CSDR								
TAJ-HN09								
TAJ-G009								
TAJ-CP10								
TAJ-GS09								
TAJ-LL09								
TAJ-LS09								
TAJ-NTSBTS								
TAJ-SPDR								
TAJ-PTDR								
TAJ-HNDR								
TAJ-LSDR								

MARKING TOOLS

Permanency of TAJIMA Chalk

Permanency Level Chalk Series	1	2	3	4	5
	Standard	High-Visibility	Semi-Permanent	Permanent	Ultimate Permanency
SNAP LINE DYE	—	—	—	 DARK WHITE / DARK BLUE BLACK	 DARK RED
MICRO CHALK	 WHITE	 YELLOW / BLUE	 RED	—	—
FLUORESCENT MICRO CHALK	 GREEN	 YELLOW / BLUE / PINK	—	—	—
Best for	Interior	Interior / Exterior	Exterior		
Applications	<ul style="list-style-type: none"> • Remodeling • Interior Trim • Interior Decorating • Cabinet Installation 	<ul style="list-style-type: none"> • Roofing • Siding • Paneling • Interior Layout 	<ul style="list-style-type: none"> • Corrections • Plumbing / Electrical • Roofing • Masonry 	<ul style="list-style-type: none"> • Exterior Layout • Concrete Layout • Roofing • Steel & Metal Fabrication 	<ul style="list-style-type: none"> • Exterior Layout • Concrete Layout • Extreme Conditions • Long Term Applications
Benefits	<ul style="list-style-type: none"> • Eliminates need for priming before painting • Wipes off smooth and rough surfaces with a cloth cleanly 	<ul style="list-style-type: none"> • Temporary marking-chalk • Provides great visibility • Use to show layout changes and corrections 	<ul style="list-style-type: none"> • For semi-permanent marking projects • Use to show layout changes and corrections 	<ul style="list-style-type: none"> • Weather resistant lines remain visible after weeks of weather, sun and jobsite wear and tear 	<ul style="list-style-type: none"> • Weatherproof lines reduces the need for spraying a sealant on snapped lines • Stains surfaces



MARKING TOOLS

SNAP LINE DYE



• Ultra-fine powdered chalk for semi-permanent marking tasks

ITEM CODE		COLOR	CASE	MASTER CARTON	UPC
PLC3-BK300	10.5 oz. / 300 g	Black	6	60	0-49296-05590-5
PLC3-DR300		Red			0-49296-05589-9
PLC3-DW300		White			0-49296-05776-3
PLC3-DB300		Blue			0-49296-05777-0
PLC3-BK900	32 oz. / 907 g	Black	24	6	0-49296-05718-3
PLC3-DR900		Red			0-49296-05716-9
PLC3-DW900		White			0-49296-05847-0
PLC3-DB900		Blue			0-49296-05848-7
PLC3-BK2700	6 lbs. / 2700 g	Black	2	6	0-49296-05833-3
PLC3-DR2700		Red			0-49296-05834-0
PLC3-DW2700		White			0-49296-05849-4
PLC3-DB2700		Blue			0-49296-05850-0

MICRO CHALK



• Coats the line evenly and thoroughly for bold, uniform lines

ITEM CODE		COLOR	CASE	MASTER CARTON	UPC
PLC2-B300	10.5 oz. / 300 g	Blue	6	60	0-49296-05511-0
PLC2-R300		Red			0-49296-05512-7
PLC2-W300		White			0-49296-05510-3
PLC2-Y300		Yellow			0-49296-05513-4
PLC2-B900	32 oz. / 907 g	Blue	24	6	0-49296-05717-6
PLC2-R900		Red			0-49296-05715-2
PLC2-W900		White			0-49296-05841-8
PLC2-Y900		Yellow			0-49296-05842-5
PLC2-B2700	6 lbs. / 2700 g	Blue	2	6	0-49296-05843-2
PLC2-R2700		Red			0-49296-05844-9
PLC2-W2700		White			0-49296-05845-6
PLC2-Y2700		Yellow			0-49296-05846-3

FLUORESCENT MICRO CHALK



• Fluorescent colors for superior visibility

ITEM CODE		COLOR	CASE	MASTER CARTON	UPC
PLC2-FG300	10.5 oz. / 300 g	Green	6	60	0-49296-05778-7
PLC2-FY300		Yellow			0-49296-05779-4
PLC2-FB300		Blue			0-49296-05780-0
PLC2-FP300		Pink			0-49296-05781-7
PLC2-FG900	32 oz. / 907 g	Green	24	6	0-49296-05851-7
PLC2-FY900		Yellow			0-49296-05852-4
PLC2-FB900		Blue			0-49296-05853-1
PLC2-FP900		Pink			0-49296-05854-8
PLC2-FG2700	6 lbs. / 2700 g	Green	2	6	0-49296-05855-5
PLC2-FY2700		Yellow			0-49296-05856-2
PLC2-FB2700		Blue			0-49296-05857-9
PLC2-FP2700		Pink			0-49296-05858-6

MARKING TOOLS

INK-RITE®



- Precision snap line uses ink to create bold, permanent lines
- Automatic winding mechanism

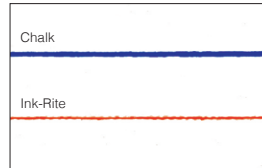

ITEM CODE	LINE LENGTH		CASE	MASTER CARTON	UPC
IR101S-0	0.02 in (0.6 mm) x 25 ft (7.5 m)	AUTO WIND	6	36 (6 sets)	0-49296-05461-8



QUICK DRY INK



PSB2-180

PSS2-180

- Snap line ink ideal for permanent dry surface marking
- Spill-proof nozzles

ITEM CODE		COLOR	CASE	MASTER CARTON	UPC
PSB2-180	6 fl. oz. x 180 ml		3	60	0-49296-05408-3
PSS2-180					0-49296-05409-0

INK-RITE® REPLACEMENT LINE

- Premium braided nylon line for the Ink-Rite marking tool



ITEM CODE	LINE LENGTH	CASE	MASTER CARTON	UPC
PS-ITOS	0.02 in (0.6 mm) x 130 ft (40 m)	10	100	0-49296-05432-8

INK-RITE® REPLACEMENT SPONGE













ITEM CODE	CASE	MASTER CARTON	UPC
M21-WAT	1	100	0-49296-05464-9

CAULK GUNS



CAULK GUNS

SPECIFICATIONS AND FUNCTIONS TABLE

CONVOY SERIES		CARTRIDGE SIZE	WEIGHT	MATERIALS		FUNCTIONS	THRUST SYSTEMS	THRUST RATIO	VISCOSITY
				BARRELS	GRIPS				
CONVOY® SUPER 26 DUO™ Pg. 21		22 fl. oz. / 650 ml 16 fl. oz. / 450 ml	58 oz. / 1,650 g	Metal	Metal	—	TT System	26 : 1	6 5 4 3 2 1
CONVOY® SUPER 26 SAUSAGE GUN 2WAY™ Pg. 22		10 fl. oz. / 300 ml	39 oz. / 1,100 g	Metal	Metal	360° RH	Enhanced SST	26 : 1	6 5 4 3 2 1
CONVOY® SUPER SAUSAGE GUN 2WAY™ Pg. 22		20 fl. oz. / 600 ml	35 oz. / 990 g	Metal	Metal • Resin	360° RH AFS System	TT System	12 : 1	6 5 4 3 2 1
CONVOY® BULK SUPER 3WAY™ Pg. 23		10 fl. oz. / 300 ml	42 oz. / 1,200 g	Aluminum	Aluminum	360° RH	Enhanced SST	10 : 1	6 5 4 3 2 1
CONVOY® RS™ Pg. 23		10 fl. oz. / 300 ml	26 oz. / 740 g	Metal	Resin	360° RH	DP Enhanced SST	8 : 1	6 5 4 3 2 1
		30 fl. oz. / 900 ml	33 oz. / 940 g					16 : 1	6 5 4 3 2 1
CONVOY® SUPER™ 26 Pg. 24		10 fl. oz. / 300 ml	25 oz. / 710 g	Metal	Metal • Resin	360° RH	Enhanced SST	26 : 1	6 5 4 3 2 1
		30 fl. oz. / 900 ml	35 oz. / 1,005 g					26 : 1	6 5 4 3 2 1
CONVOY® SUPER™ 18 Pg. 24		10 fl. oz. / 300 ml	25 oz. / 710 g	Metal	Metal • Resin	360° RH	Enhanced SST	18 : 1	6 5 4 3 2 1
		30 fl. oz. / 900 ml	35 oz. / 1,005 g					18 : 1	6 5 4 3 2 1
CONVOY® SUPER™ Pg. 25		10 fl. oz. / 300 ml	25 oz. / 710 g	Metal	Metal • Resin	360° RH AFS System	TT System	12 : 1	6 5 4 3 2 1
		30 fl. oz. / 900 ml	35 oz. / 1,005 g					12 : 1	6 5 4 3 2 1
CONVOY® PLUS II™ Pg. 25		10 fl. oz. / 300 ml	21 oz. / 605 g	Metal	Resin	360° RH AFS System	TT System	7 : 1	6 5 4 3 2 1
		30 fl. oz. / 900 ml	32 oz. / 900 g					7 : 1	6 5 4 3 2 1
CONVOY® LITE™ Pg. 26		10 fl. oz. / 300 ml	17 oz. / 480 g	Resin	Resin	AFS System	TT System	7 : 1	6 5 4 3 2 1

THRUST SYSTEM



DP Dual Power™
Pull the lever down for hard materials, press up for soft materials. In the down position, thrust force is increased by about 40%.



Enhanced SST **Enhanced SST™**
With a 20% larger contact surface area between plunger and valve plate, there is no loss in thrust force.

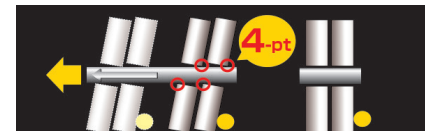

TT System **Twin Thrust System™**
The four-point system strengthens thrust force on the plunger. This means it can be used with ease, even with hard materials.

FUNCTIONS

360° RH **360° Rotating Handle™**
Ideal for maneuvering in and around tight spaces.

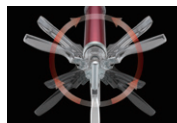

AFS System **Auto Flow Stop System™**
Plunger retracts a few millimeters after every push, efficiently stopping flow.



CAULK GUNS



Convoy® Super 26 DUO™





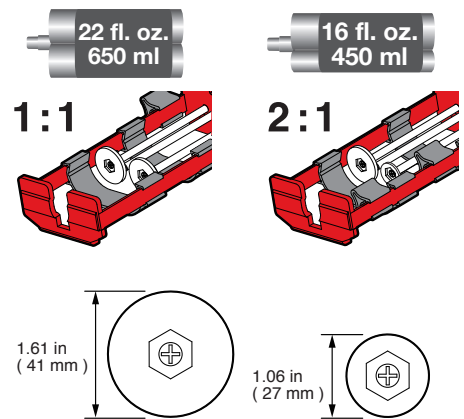

- For dual component adhesive cartridges
- Compatible with 1:1 and 2:1 cartridges



STROKE DISTANCE
0.2 in (4 mm)



ITEM CODE					CASE	MASTER CARTON	UPC
CNV-DSP26	58 oz. / 1,650 g	26 : 1	22 fl. oz. / 650 ml	16 fl. oz. / 450 ml	1	4	0-49296-26682-0

CAULK GUNS

CONVOY® SUPER SAUSAGE GUN 2WAY™

Removing the piston allows two material types (sausage or cartridge) to be used. No tools are needed for piston replacement.





CONVOY® SUPER SAUSAGE GUN 2WAY™

Enhanced SST 360° RH



CNV-FSP26-600

STROKE DISTANCE

0.2 in (4 mm)

TT System 360° RH AFS System



CNV-FSP600

STROKE DISTANCE

0.3 in (7 mm)

- Compatible with sausage and cartridge refills
- Removable plunger
- Uniquely designed front cap enables every ounce of material to be released from the tube
- Anti-residue surface

QUICK PLUNGER™

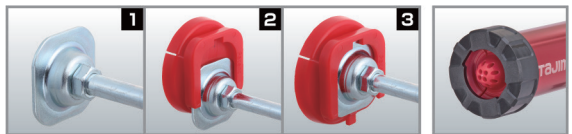

Twin-Thrust System™







Straight nozzle for 2way large 3pcs
CNV-FSNL
0-49296-26514-4

Straight nozzle for 2way 3pcs
CNV-FSN
0-49296-26513-7

Plunger for 2way
CNV-FSP
0-49296-26515-1

Front cap for 2way
CNV-FFC
0-49296-26516-8



ITEM CODE					CASE	MASTER CARTON	UPC
CNV-FSP26-600	39 oz. / 1,100 g	26 : 1	10 fl. oz. / 300 ml	20 fl. oz. / 600 ml	4	16	0-49296-26683-7
CNV-FSP600	35 oz. / 990 g	12 : 1					0-49296-26512-0

CAULK GUNS

CONVOY® BULK SUPER 3WAY™

Enhanced SST 360° RH



- Supports three refill types : bulk, sausage pack and cartridge
- The Enhanced SST system
- Die-cast aluminum trigger & grip
- Anti-leakage rubber gasket on piston
- Anti-residue surface

Enhanced SST™



One-touch exchangeable pistons



Plunger depressor lock



View Our Video



Sausage pack piston
CNVBP-SP
0-49296-26021-7

Straight nozzle
CNVBP-SN
0-49296-26024-8

Bent nozzle
CNVBP-BN
0-49296-26025-5

Lubricant oil



STROKE DISTANCE
0.3 in (8.5 mm)

ITEM CODE						CASE	MASTER CARTON	UPC
CNVBSP3W550	42 oz. / 1,200 g	10 : 1	10 fl. oz. / 300 ml	13 fl. oz. / 400 ml	Up to 18 fl. oz. / 550 ml max	1	4	0-49296-26019-4

CONVOY® RS™

DP Enhanced SST 360° RH



CNV-100RS

- With the Enhanced SST feature, experience 20% stronger thrust force with no additional effort on your part
- Dual Power, 360 Rotating Handles with contoured grips
- Extra-long seal puncture pin
- Ideal for dispensing thick, viscous materials

Dual Power™



Seal Puncture Pin



Enhanced SST™



View Our Video

STROKE DISTANCE
soft materials 0.2 in (6 mm)
hard materials 0.5 in (12 mm)



ITEM CODE				CASE	MASTER CARTON	UPC
CNV-100RS	26 oz. / 740 g	8 : 1	10 fl. oz. / 300 ml	6	24	0-49296-16855-1
CNV-900RS	33 oz. / 940 g	16 : 1	30 fl.oz. / 900 ml	4	16	0-49296-26517-5

CAULK GUNS

CONVOY® SUPER™ 26

Enhanced
SST 360°
RH



CNV-100SP26

- With the Enhanced SST feature, experience 20% stronger thrust force with no additional effort on your part
- 360 Rotating Handles with elastomer non-slip grips
- Extra-long seal puncture pin
- Ideal for dispensing extra-thick, viscous materials

Enhanced SST™



Seal Puncture Pin



View Our Video

STROKE DISTANCE

0.2 in (4 mm)



ITEM CODE				CASE	MASTER CARTON	UPC
CNV-100SP26	25 oz. / 710 g	26 : 1	10 fl. oz. / 300 ml	6	24	0-49296-16561-1
CNV-900SP26	35 oz. / 1,005 g		30 fl. oz. / 900 ml	4	16	0-49296-16563-5

CONVOY® SUPER™ 18

Enhanced
SST 360°
RH



CNV-100SP18

- With the Enhanced SST feature, experience 20% stronger thrust force with no additional effort on your part
- 360 Rotating Handles with contoured grips
- Extra-long seal puncture pin
- Ideal for dispensing thick, viscous materials

Enhanced SST™



Seal Puncture Pin



STROKE DISTANCE

0.2 in (6 mm)



ITEM CODE				CASE	MASTER CARTON	UPC
CNV-100SP18	25 oz. / 710 g	18 : 1	10 fl. oz. / 300 ml	6	24	0-49296-16560-4
CNV-900SP18	35 oz. / 1,005 g		30 fl. oz. / 900 ml	4	16	0-49296-16562-8

CAULK GUNS

CONVOY® SUPER™



- Extra-long barrel caulk guns engineered for maximum performance
- Increased thrust force with the powerful Twin-Thrust System
- 360 Rotating Handles for function and convenience
- Conveniently located seal puncture pin



CNV-100SP

Twin-Thrust System™

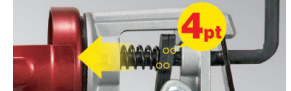

Seal Puncture Pin



STROKE DISTANCE

0.5 in (12 mm)

ITEM CODE				CASE	MASTER CARTON	UPC
CNV-100SP	25 oz. / 710 g	12 : 1	10 fl. oz. / 300 ml	6	24	0-49296-06720-5
CNV-J900SP	35 oz. / 1,005 g		30 fl. oz. / 900 ml	4	16	0-49296-06751-9

CONVOY® PLUS II™



- Extra-long barrel caulk guns
- Increased thrust force with the powerful Twin-Thrust System
- Automatic Flow-Stop system
- 360 Rotating Handles
- Conveniently located seal puncture pin



CNV-100PL2

Twin-Thrust System™



Seal Puncture Pin



STROKE DISTANCE

0.5 in (12 mm)

ITEM CODE				CASE	MASTER CARTON	UPC
CNV-100PL2	21 oz. / 605 g	7 : 1	10 fl. oz. / 300 ml	6	24	0-49296-06696-3
CNV-J900PL2	32 oz. / 900 g		30 fl. oz. / 900 ml	4	16	0-49296-06705-2

CAULK GUNS

CONVOY® LITE™



- Ultra-lightweight caulk guns help alleviate fatigue from extended use
- Unique twist-lock barrel removal system allows for fast and easy tube changes
- Increased thrust force with the powerful twin-thrust dispensing system
- Automatic flow-stop mechanism



Twist-Lock Barrel Removal System





Twin-Thrust System™



STROKE DISTANCE

0.4 in (10 mm)



















ITEM CODE				CASE	MASTER CARTON	UPC
CNV-100LT	17 oz. / 480 g	7 : 1	10 fl. oz. / 300 ml	6	24	0-49296-06628-4



MEASURING TAPES

PRODUCT SPECIFICATION TABLE

MEASURING TAPES CATEGORY		HOOK		
		STEEL HOOK	TEMPERED STEEL HOOK	STRONG HOOK
	<p>SIGMA STOP™</p> <p>0.6 in × 10 ft 1.0 in × 16 ft 1.0 in × 25 ft</p> <p>Pg. 31</p>	<ul style="list-style-type: none"> • SS-10BW 		<ul style="list-style-type: none"> • SS-16BW • SS-16/5MBW • SS-25BW • SS-25/7.5MBW • SSSF-16BW • SSSF-16/5MBW • SSSF-25BW • SSSF-25/7.5MBW 
	<p>GS-LOCK™</p> <p>1.0 in × 16 ft 1.1 in × 25 ft</p> <p>Pg. 32 · 33 · 34</p>			<ul style="list-style-type: none"> • GS-16BW • GS-16/5MBW • GS-25BW • GS-25/7.5MBW • GSSF-16BW • GSSF-16/5MBW • GSSF-25BW • GSSF-25/7.5MBW • GS-C16BW • GS-C16/5MBW 
	<p>G-PLUS™</p> <p>1.0 in × 16 ft 1.0 in × 25 ft 1.0 in × 30 ft</p> <p>Pg. 37</p>		<ul style="list-style-type: none"> • GP-16BW • GP-25BW • GP-30BW 	
	<p>G-SERIES™</p> <p>0.5 in × 6 ft 1.0 in × 16 ft 1.0 in × 25 ft 1.0 in × 30 ft</p> <p>Pg. 37</p>	<ul style="list-style-type: none"> • G-6BW • G-16BW • G-25BW • G-30BW • G-5.5MBW • G-7.5MBW • G-16/5MBW • G-25/7.5MBW • G-33/10MBW 		
	<p>HI-LOCK™</p> <p>1.0 in × 16 ft 1.0 in × 25 ft 1.0 in × 30 ft</p> <p>Pg. 38</p>	<ul style="list-style-type: none"> • HL-16BW • HL-25BW • HL-30BW • HL-16/5MBW • HL-25/7.5MBW 		

	HOOK	TAPE		CLIP		
	HORNED MAGNETIC HOOK 	STANDARD TAPE 	STRONG TAPE DUAL SIDED BLADE  <small>Scale on both sides of blade allows you to read measurements on back</small>	BELT CLIP 	COMPATIBLE CLIP*  <small>*TAJIMA Belt Holder is sold separately.</small>	SAFETY CLIP 
			All SIGMA STOP Series 	<ul style="list-style-type: none"> • SS-10BW • SS-16BW • SS-16/5MBW • SS-25BW • SS-25/7.5MBW 		<ul style="list-style-type: none"> • SSSF-16BW • SSSF-16/5MBW • SSSF-25BW • SSSF-25/7.5MBW 
	<ul style="list-style-type: none"> • GS-MC16BW • GS-MC16/5MBW • GS-SC16BW • GS-SC16/5MBW 		All GS-LOCK Series 	<ul style="list-style-type: none"> • GS-16BW • GS-16/5MBW • GS-25BW • GS-25/7.5MBW 	<ul style="list-style-type: none"> • GS-C16BW • GS-C16/5MBW • GS-MC16BW • GS-MC16/5MBW • GS-SC16BW • GS-SC16/5MBW 	<ul style="list-style-type: none"> • GSSF-16BW • GSSF-16/5MBW • GSSF-25BW • GSSF-25/7.5MBW 
		<ul style="list-style-type: none"> • GP-16BW • GP-25BW • GP-30BW 		<ul style="list-style-type: none"> • GP-16BW • GP-25BW • GP-30BW 		
		<ul style="list-style-type: none"> • G-6BW • G-25BW • G-5.5MBW • G-7.5MBW • G-16/5MBW • G-25/7.5MBW • G-33/10MBW 		<ul style="list-style-type: none"> • G-6BW • G-25BW • G-5.5MBW • G-7.5MBW • G-16/5MBW • G-25/7.5MBW • G-33/10MBW 		
		<ul style="list-style-type: none"> • HL-16BW • HL-25BW • HL-30BW • HL-16/5MBW • HL-25/7.5MBW 		<ul style="list-style-type: none"> • HL-16BW • HL-25BW • HL-30BW • HL-16/5MBW • HL-25/7.5MBW 		

MEASURING TAPES

SIGMA
Σ STOP™
 Auto Lock & Strong Lock
DUAL LOCK MECHANISM



Retract™

- Retracts by a push of a button
- Stops tape when needed

Strong Lock™

- Locks tape stronger by press a button
- Prevents tape from sliding out

Auto Lock™

- Stops tape where pulled out
- Retracts tape by a push Retract™ button

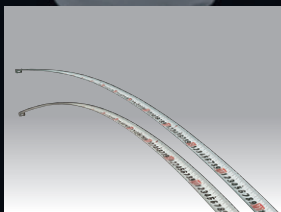

Strong Tape™
 Extra-thick steel generates more stiffness than 1 in (25 mm) standard tape measures



Strong Hook™
 Thickness 1.5 mm
 Strength 4.7 times
 (In comparison testing with standard Tajima hooks) *Except SS-10BW hook



Dual Sided Blade™
 Scale on both sides of blade allows you to read measurements on back

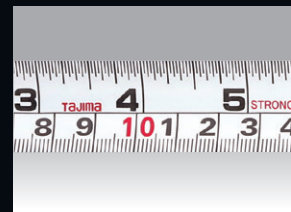

Metric and Imperial Scale
 SS-16/5MBW, SS-25/7.5MBW
 SSSF-16/5MBW, SSSF-25/7.5MBW

MEASURING TAPES

SIGMA STOP™

10 ft 16 ft 25 ft

- Dual Lock Mechanism™
- Strong Tape™ & Strong Hook™
- Dual Sided Blade™





SS-16BW



Belt clip



ITEM CODE				CASE	MASTER CARTON	UPC	
SS-10BW	0.6 in (16 mm)	10 ft	5.3 ft / 1.6 m	6	30 (5 sets)	0-49296-12219-5	
SS-16BW	1 in (25 mm)	16 ft	8.2 ft / 2.5 m			12.5 ft / 3.8 m	0-49296-12220-1
SS-16/5MBW		16 ft / 5 m					0-49296-12226-3
SS-25BW		25 ft					0-49296-12228-7
SS-25/7.5MBW	25 ft / 7.5 m	0-49296-12229-4					

SIGMA STOP™ WITH SAFETY BELT HOLDER™

16 ft 25 ft



SSSF-25BW



Locking mount





Belt holder



WEARABLE ADJUSTABLE BELT SIZES
Up to 2.4 in (60 mm) wide
Up to 0.2 in (5.5 mm) thick

- The quick-fit belt holder allows for one-handed attachment and detachment
- Extra-thick steel generates more stiffness than 1 in (25 mm) standard tape measures
- Dual Lock Mechanism™
- Strong Tape™ & Strong Hook™
- Dual Sided Blade™

ITEM CODE				CASE	MASTER CARTON	UPC
SSSF-16BW	1 in (25 mm)	16 ft	8.2 ft / 2.5 m	6	24 (4 sets)	0-49296-12227-0
SSSF-16/5MBW		16 ft / 5m				0-49296-12234-8
SSSF-25BW		25 ft				0-49296-12230-0
SSSF-25/7.5MBW		25 ft / 7.5m				0-49296-12235-5

MEASURING TAPES



GS LOCK™ series

EXTRA STIFF



Armored Case
Shock-resistant armored case protects the housing from impact during inadvertent dropping.
(GS-LOCK™, G-Plus™, G-Series)



Safety Rope Tether Mount With Ring
Prevents dropping or mislaying.
(GS-LOCK™)



Strong Tape & Hook
With a thickness of 1.6 mm, the specially designed Strong Hook has an increased strength of 4.7x more than standard Tajima hooks.
(GS-LOCK™)



End Hook Guard
Thick elastomer case armor extends around the body of the tape measure to protect end hooks and work surfaces.
(GS-LOCK™, G-Plus™, G-Series)



GS-LOCK™

16ft 25ft



• Extra-thick steel generates more stiffness than 1 in (25 mm) standard tape measures



ITEM CODE				CASE	MASTER CARTON	UPC
GS-16BW	1 in (25 mm)	16 ft	8.2 ft / 2.5 m	6	30 (5 sets)	0-49296-12199-0
GS-16/5MBW		16 ft / 5 m	12.5 ft / 3.8 m			0-49296-12200-3
GS-25BW	1.1 in (27 mm)	25 ft	8.5 ft / 2.6 m			0-49296-12202-7
GS-25/7.5MBW		25 ft / 7.5 m	12.8 ft / 3.9 m			0-49296-12203-4

MEASURING TAPES

GS-LOCK™ WITH SAFETY BELT HOLDER™

16 ft 25 ft

CLIP-IT-HOLD



GSSF-16BW

WEARABLE ADJUSTABLE BELT SIZES
Up to 2.4 in (60 mm) wide
Up to 0.2 in (5.5 mm) thick



Locking mount



Belt holder



- The quick-fit belt holder allows for one-handed attachment and detachment
- Extra-thick steel generates more stiffness than 1 in (25 mm) standard tape measures
- Thick elastomer case armor extends around the body of the tape measure to protect end hooks and work surfaces



ITEM CODE				CASE	MASTER CARTON	UPC
GSSF-16BW	1 in (25 mm)	16 ft	8.2 ft / 2.5 m	6	24 (4 sets)	0-49296-12201-0
GSSF-16/5MBW		16 ft / 5m	12.5 ft / 3.8 m			0-49296-12232-4
GSSF-25BW	1.1 in (27 mm)	25 ft	8.5 ft / 2.6 m			0-49296-12204-1
GSSF-25/7.5MBW		25 ft / 7.5m	12.8 ft / 3.9 m			0-49296-12233-1

GS-LOCK™ COMPATIBLE CLIP

16 ft

CLIP-IT-HOLD



GS-C16BW



STRONG HOOK™

Thickness 1.6 mm 4.7 times stronger than standard model.



Compatible clip



*TAJIMA Belt holder is sold separately.



- Compatible clip is newly designed to allow for TAJIMA Safety Holder
- Extra-thick steel generates more stiffness than 1 in (25 mm) standard tape measures
- Thick elastomer case armor extends around the body of the tape measure to protect end hooks and work surfaces



ITEM CODE				CASE	MASTER CARTON	UPC
GS-C16BW	1 in (25 mm)	16 ft	8.2 ft / 2.5 m	6	30 (5 sets)	0-49296-12264-5
GS-C16/5MBW		16 ft / 5m	12.5 ft / 3.8 m			0-49296-12265-2

MEASURING TAPES

GS-LOCK™ HORNERD MAGNETIC HOOK COMPATIBLE CLIP

16 ft



GS-MC16BW



HORNERD MAGNETIC HOOK™

Neodymium magnet (260 mT)
enables hook to attach to the place
where it's hard to hang



Compatible clip



*TAJIMA Belt holder is sold separately.



- Compatible clip is newly designed to allow for TAJIMA Safety Holder
- Extra-thick steel generates more stiffness than 1 in (25 mm) standard tape measures
- Thick elastomer case armor extends around the body of the tape measure to protect end hooks and work surfaces



ITEM CODE				CASE	MASTER CARTON	UPC
GS-MC16BW	1 in (25 mm)	16 ft	8.2 ft / 2.5 m	6	30 (5 sets)	0-49296-12266-9
GS-MC16/5MBW		16 ft / 5 m	12.5 ft / 3.8 m			0-49296-12267-6

GS-LOCK™ MAGNETIC POWER x 2 COMPATIBLE CLIP

16 ft



GS-SC16BW

STRONG MAGNETIC MOUNT



Neodymium magnet (340 mT)
specially built-in the body.
Attaches firmly to single pipe and LGS.



HORNERD MAGNETIC HOOK™



Compatible clip



*TAJIMA Belt holder is sold separately.



- Compatible clip is newly designed to allow for TAJIMA Safety Holder
- Extra-thick steel generates more stiffness than 1 in (25 mm) standard tape measures
- Thick elastomer case armor extends around the body of the tape measure to protect end hooks and work surfaces



ITEM CODE				CASE	MASTER CARTON	UPC
GS-SC16BW	1 in (25 mm)	16 ft	8.2 ft / 2.5 m	6	30 (5 sets)	0-49296-12268-3
GS-SC16/5MBW		16 ft / 5 m	12.5 ft / 3.8 m			0-49296-12269-0

MEASURING TAPES

CLIP-n-HOLD™ SAFETY BELT HOLDER™



SF-BHLD



SF-BHLD-BK

- Allows one-handed hooking/unhooking
- Prevents from dropping or mislaying

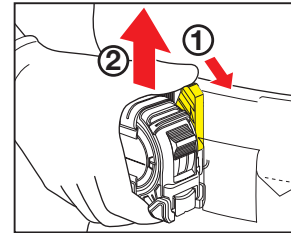

① Press & Hold Button ② Lift up

ITEM CODE	CASE	MASTER CARTON	UPC
SF-BHLD	6	60	0-49296-02995-1
SF-BHLD-BK			0-49296-12253-9



WEARABLE ADJUSTABLE BELT SIZES
Up to 2.4 in (60 mm) wide
Up to 0.2 in (5.5 mm) thick

CLIP-n-HOLD™ BELT CLAMPING SYSTEM



- For waist belts Slide Stopper Included
- Prevents from dropping or mislaying



ITEM CODE	CASE	MASTER CARTON	UPC
SF-CHLD	6	60	0-49296-16913-8



WEARABLE ADJUSTABLE BELT SIZES
Up to 2.0 in (53 mm) wide
Up to 0.1 in (3 mm) thick

CLIP-n-HOLD™ BELT CLAMPING SYSTEM FOR VERTICAL HARNESS



- For vertical harness belts
- Prevents from dropping or mislaying



ITEM CODE	CASE	MASTER CARTON	UPC
SF-THLD	6	60	0-49296-16915-2



WEARABLE ADJUSTABLE BELT SIZES
Up to 1.8 in (48 mm) wide
Up to 0.1 in (3 mm) thick

MEASURING TAPES

CLIP-n-HOLD™ METAL BODIED



- For waist belts
- Rugged metal construction



ITEM CODE	CASE	MASTER CARTON	UPC
SF-MHLD	6	60	0-49296-16914-5

WEARABLE ADJUSTABLE BELT SIZES
Up to 2.4 in (60 mm) wide
Up to 0.1 in (3 mm) thick

CLIP-n-HOLD™ METAL BODIED FOR VERTICAL HARNESS



- For vertical harness belts
- Rugged metal construction



ITEM CODE	CASE	MASTER CARTON	UPC
SF-MTHLD	6	60	0-49296-26295-2

WEARABLE ADJUSTABLE BELT SIZES
Up to 1.8 in (48 mm) wide
Up to 0.1 in (3 mm) thick

LOOP for CLIP-n-HOLD™



WEARABLE ADJUSTABLE BELT SIZES
Up to 2.9 in (75 mm) wide
Up to 0.3 in (8 mm) thick

ITEM CODE	CASE	MASTER CARTON	UPC
SF-LOOP	1	100	0-49296-12272-0

SAFETY ROPE™

- For Attached Tool Weights: up to 20 oz (567 g)
 - Standard Overall Length: 16.5 in (420 mm) (max, including halter snap)
 - Extended Length: 59.1 in (1,500 mm) (including halter snap)
 - Rope Tether Diameter: 0.1 in (3.2 mm) (polyurethane resin)
 - Core Diameter: 0.03 in (0.8 mm) (Vectran*)
- *Vectran is a registered trademark of Kuraray Co. Ltd.



ITEM CODE	CASE	MASTER CARTON	UPC
AZS-ROP	6	60	0-49296-02993-7

MEASURING TAPES



G-PLUS™



GP-25BW

- The Hyper-Acry-Coat protective blade coating is non-reflective and provides superior scale readability
- Tempered steel Ultra-Hard End Hooks with 4-rivet attachment ensures consistently accurate inside and outside measurements
- Thick elastomer case armor extends around the body of the tape measure to protect end hooks and work surfaces



ITEM CODE				CASE	MASTER CARTON	UPC	
GP-16BW		16 ft				0-49296-02858-9	
GP-25BW	1 in (25 mm)	25 ft	7.87 ft / 2.4 m	12.5 ft / 3.8 m	4	40	0-49296-02859-6
GP-30BW		30 ft					0-49296-02860-2



G-SERIES™



G-25BW

- Shock-resistant, armored case
- The Hyper-Acry-Coat protective blade coating is non-reflective and provides superior scale readability
- Triple-riveted end hooks
- Cushioned end hook returns



ITEM CODE				CASE	MASTER CARTON	UPC	
G-6BW	0.5 in (12.7 mm)	6 ft	4 ft / 1.2 m	5.25 ft / 1.6 m	60	0-49296-02681-3	
G-16BW		16 ft				0-49296-02481-9	
G-25BW		25 ft				0-49296-02459-8	
G-30BW		30 ft				0-49296-02527-4	
G-5.5MBW	1 in (25 mm)	5.5 m	7.87 ft / 2.4 m	12.5 ft / 3.8 m	6	30 (5 sets)	0-49296-02985-2
G-7.5MBW		7.5 m					0-49296-02986-9
G-16/5MBW		16 ft / 5 m					0-49296-02918-0
G-25/7.5MBW		25 ft / 7.5 m					0-49296-02460-4
G-33/10MBW		33 ft / 10 m					0-49296-02919-7

MEASURING TAPES



HI-LOCK™



HL-25BW



- The Hyper-Acry-Coat protective blade coating is non-reflective and provides superior scale readability
- Compact, ergonomic ABS case

ITEM CODE				CASE	MASTER CARTON	UPC	
HL-16BW	1 in (25 mm)	16 ft	7.87 ft / 2.4 m	12.5 ft / 3.8 m	6	60	0-49296-02414-7
HL-25BW		25 ft			12	48 (4 sets)	0-49296-02412-3
HL-30BW		30 ft			4	20	0-49296-02458-1
HL-16/5MBW		16 ft / 5 m			6	60	0-49296-02415-4
HL-25/7.5MBW		25 ft / 7.5 m					0-49296-02413-0

LED LIGHTS



LED LIGHTS

Pick the LED LIGHT that best fits your needs

BEAM TYPE

Great for detailed work FLOOD BEAM™



Lights up work clearly with an even luminosity. Fine wiring and surface of materials are visible closely, which is ideal for detailed work. This uniform light is easy on the eyes and less fatigue with low reflection.

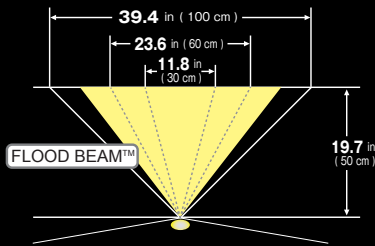

FLOOD BEAM™ Represents the angle at which the brightness of the light with an even luminosity from main body drops to 0%.

Light up a large area WIDE-ANGLE BEAM



The center beam emits the subject crisply and brightly, while the ambient beam shines on a wide area clearly from top to bottom. The spread light is ideal for work site or outdoor work with low-light condition to work safely.

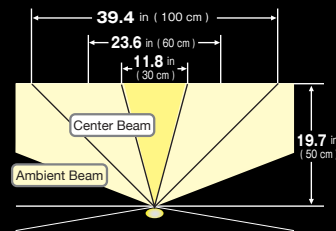

Center Beam Represents the irradiation angle until the brightness of the optical axis drops to 20%.

Ambient Beam Represents the angle at which the brightness of the light emitted outside the center beam drops to 0%.

LED LIGHTS SERIES	 LE-E502D-SP Pg. 41	 LE-F502D Pg. 42	 LE-SF501D-SP Pg. 44	 LE-SF352D Pg. 45	 LE-F501D Pg. 43	 LE-M501D Pg. 43	 LE-SF351D Pg. 45
BATTERY	 LE-ZP3730 or AA 1.5V x 4	AA 1.5V x 3	 LE-ZP3730 or AA 1.5V x 4	AA 1.5V x 3	AA 1.5V x 3	AAA 1.5V x 3	AA 1.5V x 3

LED LIGHTS



GRATI-LITE™ LE-E502D-SP

500_{lm}



LE-ZP3730

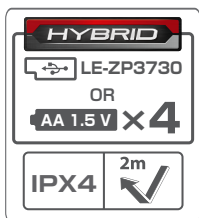

- FLOOD BEAM™ is ideal for work at hand with an even luminosity
- Hybrid power source takes dedicated rechargeable battery (included) or AA batteries
- The external battery compartment can be easily opened or closed with gloves on
- 3 modes of brightness: 50 lm → 250 lm → 500 lm
- Over hard hat band fits nicely on the helmet
- Helmet clips prevent the light from slipping off during work
- Flicker-Free light



FLOOD BEAM™



Works with Li-ion rechargeable battery or AA batteries



Press the button to switch the lighting modes



Helmet clips

Specifications

FL 1 STANDARD	MODE 3	MODE 2	MODE 1	FL 1 STANDARD	LE-E502D-SP
	500 LUMENS	250 LUMENS	50 LUMENS		2m 307 cd
	8h	12h	21h		83°
	35m				

ITEM CODE	CASE	MASTER CARTON	UPC
LE-E502D-SP	6	24	0-49296-26710-0

LED LIGHTS



FLOOD BEAM™ is designed to produce bright light and makes it easy to see wiring and surface material

GRATI-LITE™ LE-F502D

500lm



- FLOOD BEAM™ is ideal for work at hand with an even luminosity
- The external battery compartment can be easily opened or closed with gloves on
- 3 modes of brightness: 50 lm → 250 lm → 500 lm
- Over hard hat band fits nicely on the helmet
- Helmet clips prevent the light from slipping off during work
- Flicker-Free light



FLOOD BEAM™



Works with AA batteries



Press the button to switch the lighting modes



Helmet clips

Specifications

FL1 STANDARD	MODE 3	MODE 2	MODE 1	FL1 STANDARD	LE-F502D
	500 LUMENS	250 LUMENS	50 LUMENS		2m
	6h	10h	25h		FLOOD BEAM
	35m				83°

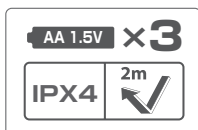

ITEM CODE	CASE	MASTER CARTON	UPC
LE-F502D	6	24	0-49296-26709-4

LED LIGHTS

GRATI-LITE™ LE-F501D

500_m



View Our Video

AA 1.5V x3

IPX4 2m



- Illuminated surface diameter is approximately 39.3 in (100 cm) when emitted at 19.6 in (50 cm) away from the subject
- The external battery compartment can be easily opened or closed with gloves on



WIDE-ANGLE BEAM



Works with AA batteries



The external battery compartment

Specifications

FL1 STANDARD	MODE 3	MODE 2	MODE 1	FL1 STANDARD	LE-F501D
	500 LUMENS	250 LUMENS	50 LUMENS	2m 3480cd	
	6h	10h	25h	LIGHT DISTRIBUTION Center Light Beam: 26° Ambient Light Beam: 165°	
	118m				

ITEM CODE	CASE	MASTER CARTON	UPC
LE-F501D	6	24	0-49296-26679-0

GRATI-LITE™ LE-M501D

500_m



View Our Video

AAA 1.5V x3

IPX4 2m



- Illuminated surface diameter is approximately 36.6 in (93 cm) when emitted at 19.6 in (50 cm) away from the subject
- Strong Neodymium magnet on the back
- Detachable, rotate and slide mechanism
- Shut-off mode prevents accidental activation and battery depletion



WIDE-ANGLE BEAM



Works with AAA batteries



Magnet on the back

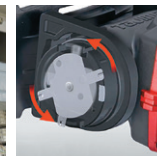

Shut-off Dial

Specifications

FL1 STANDARD	MODE 3	MODE 2	MODE 1	FL1 STANDARD	LE-M501D
	500 LUMENS	250 LUMENS	50 LUMENS	2m 2500cd	
	4h	6h	15h	LIGHT DISTRIBUTION Center Light Beam: 32° Ambient Light Beam: 86°	
	100m				

ITEM CODE	CASE	MASTER CARTON	UPC
LE-M501D	6	24	0-49296-26680-6

LED LIGHTS

HYBRID

500^{lm}

GRATI-LITE™

LE-SF501D-SP

FLOOD BEAM™

FLOOD BEAM™ is designed to produce bright light and makes it easy to see wiring and surface material



View Our Video

LED Detachable Work Light with belt clamping system



Common features to "SF" series



Use as a hand-held flashlight or as a work light



Swivel head to aim the light

GRATI-LITE™ LE-SF501D-SP

500^{lm}

CLIP-n-HOLD™



HYBRID

LE-ZP3730
OR
AA 1.5V x 4

IPX4 

- FLOOD BEAM™ is ideal for work at hand with an even luminosity
- Hybrid power source takes dedicated rechargeable battery (included) or AA batteries
- Safety Holder that can be attached to the vertical harness belt
- 3 modes of brightness: 50 lm → 250 lm → 500 lm
- Flicker-Free light
- A molded hole for lanyard attachments to prevent dropping



FLOOD BEAM™



Hybrid power source takes dedicated rechargeable battery (included) or AA batteries









Neodymium magnet can be attached to any ferromagnetic metal surface like steel



Can be attached facing up or down

Specifications

FL1 STANDARD	MODE 3	MODE 2	MODE 1	FL1 STANDARD	LE-SF501D-SP
	500 LUMENS	250 LUMENS	50 LUMENS		2m 
	8h	12h	21h	LIGHT DISTRIBUTION FLOOD BEAM	
	35m			 83°	



ITEM CODE	CASE	MASTER CARTON	UPC
LE-SF501D-SP	6	24	0-49296-26716-2

LED LIGHTS

GRATI-LITE™ LE-SF352D

350_{lm}

CLIP-n-HOLD™



AA 1.5V × 3
IPX4 2m

- FLOOD BEAM™ is ideal for work at hand with an even luminosity
- Safety Holder that can be attached to the vertical harness belt
- 3 modes of brightness: 15 lm → 150 lm → 350 lm
- Strong Neodymium magnet on the back
- Flicker-Free light
- A molded hole for lanyard attachments to prevent dropping



FLOOD BEAM™



Works with AA batteries



Neodymium magnet attach the light to pipes, steels, etc



Can be attached facing up or down

Specifications

FL1 STANDARD	MODE 3	MODE 2	MODE 1	FL1 STANDARD	LE-SF352D
	350 LUMENS	150 LUMENS	15 LUMENS		
	8h	20h	65h		
	30 m				

LIGHT DISTRIBUTION
FLOOD BEAM
83°



ITEM CODE	CASE	MASTER CARTON	UPC
LE-SF352D	6	24	0-49296-26717-9

GRATI-LITE™ LE-SF351D

350_{lm}

CLIP-n-HOLD™



AA 1.5V × 3
IPX4 2m

- Safety Holder that can be attached to the vertical harness belt
- 3 modes of brightness: 15 lm → 150 lm → 350 lm
- Can be used as a work light
- Flicker-Free light
- A molded hole for lanyard attachments to prevent dropping
- Strong Neodymium magnet on the back



WIDE-ANGLE BEAM



Works with AA batteries



Powerful Neodymium Magnet



Ideal for recreational use on your backpack

Specifications

FL1 STANDARD	MODE 3	MODE 2	MODE 1	FL1 STANDARD	LE-SF351D
	350 LUMENS	150 LUMENS	15 LUMENS		
	8h	20h	65h		
	108m				

LIGHT DISTRIBUTION
Center Light Beam 24°
Ambient Light Beam 163°



ITEM CODE	CASE	MASTER CARTON	UPC
LE-SF351D	6	24	0-49296-26681-3

LITHIUM-ION BATTERY ZP3730

3.7V



- High-capacity, long-lasting battery
- Voltage: 3.7V; Capacity: 3000mAh

ITEM CODE	CASE	MASTER CARTON	UPC
LE-ZP3730	1	96	0-49296-16558-1

DRYWALL TOOLS



DRYWALL TOOLS



DRYWALL CHAMFER™

- Smooth work with durable aluminum die-cast and FLUORO COAT™



Adjustment Plate



View Our Video

DRYWALL CHAMFER™



- Adjustment plate for 4 settings of chamfer width
TBK180-H45 : 0.04 in (1 mm), 0.06 in (1.5 mm),
0.08 in (2 mm), 0.12 in (3 mm)

Ideal for

Plasterboards, Calcium silicate boards

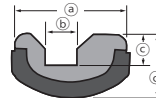

- Ⓐ 2.25 in (57 mm)
- Ⓑ 0.59 in (15 mm)
- Ⓒ 0.63 in (16 mm)
- Ⓓ 1.18 in (30 mm)

Dual-purpose

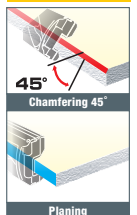

ITEM CODE	CASE	MASTER CARTON	UPC
TBK180-H45	6	36	0-49296-05631-5

DRYWALL CHAMFER™ PLANE30°



- Adjustment plate for 4 settings of chamfer width
TBK180-V30 : 0.04 in (1 mm), 0.08 in (2 mm),
0.12 in (3 mm), 0.16 in (4 mm)

Ideal for

Plasterboards, Calcium silicate boards

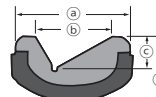

- Ⓐ 2.25 in (57 mm)
- Ⓑ 1.46 in (37 mm)
- Ⓒ 0.63 in (16 mm)
- Ⓓ 1.18 in (30 mm)

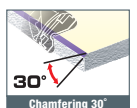

ITEM CODE	CASE	MASTER CARTON	UPC
TBK180-V30	6	36	0-49296-05630-8

DRYWALL TOOLS



DRYWALL CHAMFER™

- Rust free, durable, Ceramic Blades (16 times more durable, compared to Tajima's steel blades)
- Adjustable chamfer widths

DRYWALL CHAMFER™ PLANE45° “SUPER HARD™”

- Reinforced blade locking mechanism to minimize blade chatter
- Durable die-cast aluminum and stainless steel coated base
- 3 spare blades can be stored inside
- Compatible with 0.7 in (18 mm) or 0.9 in (22 mm) wide blades



Ideal for

Melamine non-combustible decorative panels, Plywoods, Calcium silicate boards, Plasterboards

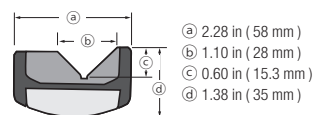
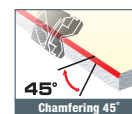

ITEM CODE	CASE	MASTER CARTON	UPC
TMK-KV45	6	36	0-49296-05827-2

CERAMIC BLADE™

for Drywall Chamfer “SUPER HARD™”



ITEM CODE	CASE	MASTER CARTON	UPC
TMKB-C50	10	100	0-49296-05829-6

DRYWALL TOOLS

DRYWALL RASP™ 5

Fine / Medium

- Angled rasping for any corners
- Specifically for detailed work



View Our Video

Drywall Rasp™ 5 **Fine / Medium**

- Detailed rasp work on plasterboard
- New tetra teeth resists clogging and sharpens in both directions
- Rasp in any directions, ideal for detailed work in inner corners
- Stainless steel fin, convenient for holding down paper on boards and tightening screws
- Fits in tool pouch, compact size
- Lightweight

Ideal for
Plasterboards



TBY-S130S



TBY-S130C

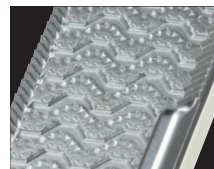

A close up of rasp (Fine)

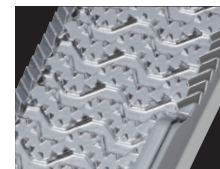

(Medium)



Stainless steel fin

ITEM CODE	CASE	MASTER CARTON	UPC
TBY-S130S	6	60	0-49296-05663-6
TBY-S130C			0-49296-05662-9

DRYWALL TOOLS



COMBINATION DRYWALL RASP™ 7

- Unique drywall rasp with three distinct grinding sections
- Efficiently grinds in both directions

Drywall Rasp™ 7

- New tetra teeth resists clogging and sharpens in both directions
- Siderail teeth are great for notching and spot grinding
- Lightweight

Ideal for
Plasterboards, Calcium silicate boards



Work horizontally to collect dust

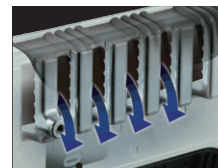

In-handle dust collection



Hold upright to empty dust

Tetra-Teeth™

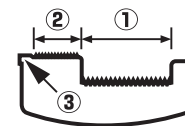
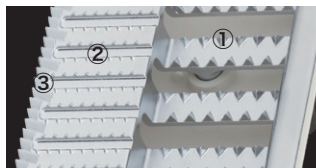

- ① Coarse teeth for fast grinding, up to 1 in (25.4 mm) thick
- ② Fine teeth for finishing
- ③ Siderail teeth for corners

ITEM CODE	CASE	MASTER CARTON	UPC
TBYD-180	6	36	0-49296-05666-7

DRYWALL TOOLS



Double-sided drywall rasp

DRYWALL RASP™ 7

- Rust free, durable, Ceramic Blades (10 times more durable than metal rasp, compared to Tajima's metal blades)
- Ideal for super hard gypsum boards
- Angled rasping for any corners



Drywall Rasp™ 7 “SUPER HARD™”

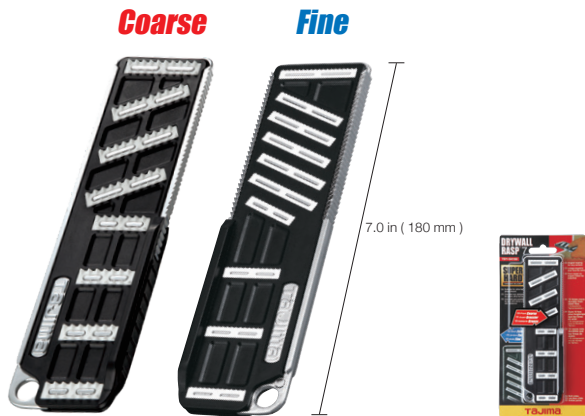

- Double-sided drywall rasp
- The tetra teeth grabs the material and cuts 20% more than a fixed blade
- Non-slip elastomer grip for a secure hold
- Lightweight

Ideal for

Plasterboards, Calcium silicate boards
Super hard gypsum boards

Endurance test: **SUPER HARD™** vs. Standard metal rasp
(comparison of wear after same usage)

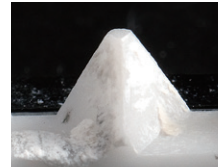

SUPER HARD™
Ceramic blade



Standard rasp teeth

10 times more durable than standard rasp

Amazing endurance - SUPER HARD™ with fine ceramic blade is longer lasting. They are made to withhold wear.



Coarse

Coarse is used to shave material quickly and harshly with the rough rasp teeth.



Fine

Fine is used to finish work smoothly with a small amount of shaving.

ITEM CODE	CASE	MASTER CARTON	UPC
TBY-SH180	6	30	0-49296-05710-7

DRYWALL TOOLS

Efficient Drywall Tools

GT JAB-SAW™

- Cuts through any drywalls



GT JAB-SAW™



- Steel-reinforced jab saw with ergonomic elastomer handle
- Replaceable heavy-duty 0.05 in (1.2 mm) thick blade with twin-rows of razor-sharp cutting teeth

Ideal for
Plasterboards, Plywoods

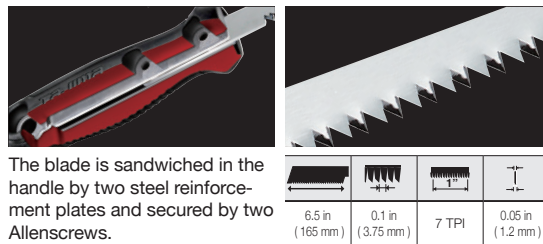

The blade is sandwiched in the handle by two steel reinforcement plates and secured by two Allenscrews.

JAPANESE TEMPERED
Unique steel hardening process that results in blades with exceptional durability and cutting performance.

IMPULSE HARDENED
Spot hardening of blade teeth to further enhance the cutting performance while not reducing blade flexibility.

ITEM CODE	CASE	MASTER CARTON	UPC
GT165JS	12	72	0-49296-11163-2

GT JAB-SAW™

Replacement Blades



ITEM CODE	CASE	MASTER CARTON	UPC
GTB165JS	3	120	0-49296-11164-9

**UTILITY KNIVES &
BLADES**





















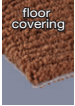















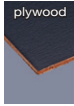



UTILITY KNIVES & BLADES

VR-SERIES UTILITY KNIVES



Rugged one-piece fixed-blade utility knife opens easily with a large thumb-screw featuring a magnetic blade retainer and spare blades clip.



BLADE TYPE	ITEM CODE		CASE	MASTER CARTON	UPC	MATERIAL SUITABILITY INDEX	CORRESPONDING KNIVES
<h3>V-REX™ II</h3> <p>Premium tempered steel blades with razor-sharp cutting edges, optimized for drywall and other heavy-duty cutting and scoring tasks.</p>  	VRB2-5B 	5	 10  50	 120  600	0-49296-11160-1	BUILDING MATERIAL    ★★ ★★ ★★	 VR-101R  VR-102B  VR-103
	VRB2-50B 	50	 10  500	 40  2,000	0-49296-11161-8	PAPER   ★★ ★★	
	VRB2-100B 	100	 10  1,000	 40  4,000	0-49296-11162-5	WOOD   ★★ ★★	
<h3>DEEP HOOK™</h3> <p>Premium-grade deep hook blades designed to prevent slipoff when cutting rigid roofing or flooring material.</p> 	HKB-5B 	5	 10  50	 120  600	0-49296-01956-3	BUILDING MATERIAL   ★★ ★★	
	HKB-50B 	50	 10  500	 40  2,000	0-49296-01956-6		

★★★ best ★★ better

UTILITY KNIVES & BLADES

VR SERIES - FIXED BLADE

- Rugged one-piece fixed blade utility knife
- Open easily with a large thumb-screw

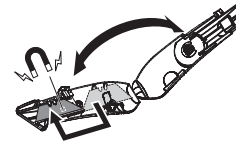

ITEM CODE		BLADE	CASE	MASTER CARTON	UPC
VR-101R	3	FIXED BLADE	12	48 (4 sets)	0-49296-01966-2

VR SERIES - RETRACTABLE BLADE

- Rugged one-piece retractable utility knife
- Opens easily with a large thumb-screw

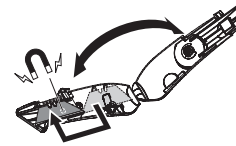

ITEM CODE		BLADE	CASE	MASTER CARTON	UPC
VR-102B	3	RETRACTABLE BLADE	12	48 (4 sets)	0-49296-01967-9

VR SERIES - SAFETY KNIFE

- Self-retracting utility knife
- Conveniently located slide lock mechanism

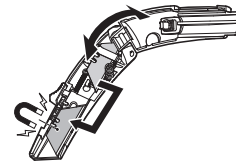

ITEM CODE		BLADE	CASE	MASTER CARTON	UPC
VR-103	3	SELF-RETRACTABLE BLADE	12	48 (4 sets)	0-49296-11024-6

UTILITY KNIVES & BLADES

THE TAJIMA DIFFERENCE

Strategically-designed blades that combine the best in material, tempering, and sharpening.



	BLADE	ITEM CODE	CASE	MASTER CARTON	UPC	CORRESPONDING KNIVES		
1 in 25 mm	Rock Hard Blade™ SK120 16 g 	 LCB-65 	10	 6 60 60 600	 60 600	0-49296-02088-0 0-49296-01815-3 0-49296-11197-7	 DC661N ACM-700SC AC-701S AC-701R	
		 LCB-65-20 CB65C	20	 6 120 60 1,200	 60 1,200	0-49296-01815-3 0-49296-11197-7	 ACM-700SC AC-701S	
		 LCB-65S CB65RBC	10	 10 100 50 500	 50 500	0-49296-01995-2 0-49296-11153-3 0-49296-11198-4	 LC-661 DFC671N-R1 LC-650 SCR-H1200	
		SOLID Rock Hard Blade™ SK120 16 g 	 LCB-65S 	10	 10 100 50 500	 50 500	0-49296-01995-2 0-49296-11153-3 0-49296-11198-4	 LC-661 DFC671N-R1 LC-650 SCR-H1200
		Razar Black Blade™ SK120 16 g 	 LCB-65RB 	10	 6 60 60 600	 60 600	0-49296-11153-3 0-49296-11198-4	 DFC671N-R1 LC-650 SCR-H1200
		 LCB-65RB CB65RBC	10	 10 100 60 600	 60 600	0-49296-11153-3 0-49296-11198-4	 DFC671N-R1 LC-650 SCR-H1200	
0.9 in 22 mm	Endura-Blade™ SK120 10 g 	 LCB-62 	10	 6 60 60 600	 60 600	0-49296-02155-9	 DC-690 LC-620 SCR-L series	

UTILITY KNIVES & BLADES



**Only SK-120
Premium Grade Steel**

The purest grade of steel ensures the strongest-possible core and results in a more accurately tooled and sharpened blade.



**Precise,
Multi-Step Sharpening**

Optimized cutting edge geometry and advanced honing techniques results in consistent, superior cutting performance.



Japanese-Style Tempering

A centuries-old process of heat-treating and hardening the steel to further maximize blade strength and cutting edge life.

OPTIMIZED BLADE GEOMETRY AND CUTTING EDGE ANGLES To ensure the best cutting performance for specific types of material.



Endura-Blade™

For general purpose scoring and cutting, ideal for work with drywall, wood and other thick materials. An extremely sharp and strong blade that integrates premium steel, Japanese-style tempering and multi-step sharpening to produce a dependable, solid feel and long cutting performance.

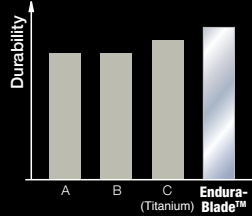

Razar Black Blade™

For precise cutting and fine material slicing, ideal for work with paper, film and other thin materials. A razor-sharp acute angle blade that integrates premium steel, Japanese-style tempering and multi-step sharpening to produce an exceptionally smooth and fine quality of cut.

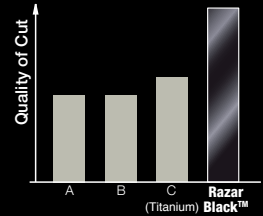

	BLADE	ITEM CODE	CASE	MASTER CARTON	UPC	CORRESPONDING KNIVES		
0.7 in 18 mm	Endura-Blade™ SK120 6 g 	LCB-50	10	100	120	1,200	DFC560N, DFC561N	
		LCB-50-50	50	10	500	50	2,500	DC540N, ACM-500C
		CB50C	10	10	100	120	1,200	AC-500B, AC-501R
	Max Point Endura-Blade™ SK120 6 g 	LCB-50D	10	10	100	120	1,200	AC-521R, DC-560
		SOLID Endura-Blade™ SK120 6 g 	LCB-50S	10	10	100	120	1,200
	Razar Black Blade™ SK120 6 g 		LCB-50RB	10	10	100	120	1,200
		LCB-50RB-50	50	10	500	50	2,500	LC-521, LC-500
		CB50RBC	10	10	100	120	1,200	LC-501, SCR-L series
0.4 in 9 mm	Endura-Blade™ SK120 2 g 	LCB-30	10	10	100	120	1,200	LC-360, LC-301
		LCB-30-50	50	10	500	100	5,000	LC-302, LC-303
	Razar Black Blade™ SK120 2 g 	LCB-30RB	10	10	100	120	1,200	DC390B
	30° Acute Angle Blade™ SK120 2 g 	CB39RBH	10	10	100	240	2,400	

UTILITY KNIVES & BLADES

Tajima

Premium Quality, Recognized Globally™



DFC560N / 561N L

- Opening cartons, scoring thick cardboard and prying off can lids





DFC560N

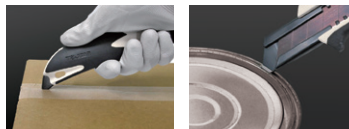

DFC561N



ITEM CODE			BLADE LOCK	CASE	MASTER CARTON	UPC
DFC560N	0.7 in (18 mm)	1	AUTO BLADE LOCK	10	120	0-49296-11189-2
DFC561N			DIAL BLADE LOCK			0-49296-11190-8

DC540N L

- Extended grip ensures safe and efficient cable stripping

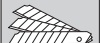

ITEM CODE			BLADE LOCK	CASE	MASTER CARTON	UPC
DC540N	0.7 in (18 mm)	1	AUTO BLADE LOCK	10	60	0-49296-11191-5

UTILITY KNIVES & BLADES

Tajima's premium-class cutter knives were specifically designed to meet the needs of professionals.

- Extra-strong tempered blade sleeves provide smooth and reliable blade extension and retraction
- High-quality cutter knives deliver superior performance and longevity
- Customized handles and grips for optimal ease of use

Slick. Sharp. Smart.



View Our Video

DC660N / 661N H 1 in (25 mm)





DC660N



DC661N

- 1 in / 25 mm cutter knives with elastomer grip, ultra-hard tempered blade sleeves and lanyard attachment hole



ITEM CODE			BLADE LOCK	CASE	MASTER CARTON	UPC
DC660N	1 in (25 mm)	1	AUTO BLADE LOCK	10	60	0-49296-11192-2
DC661N			DIAL BLADE LOCK			0-49296-11193-9

DC390B



- Tempered blade sleeve with a multifunction "micro-driver" tip

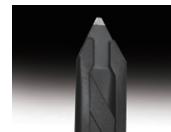

ITEM CODE			BLADE LOCK	CASE	MASTER CARTON	UPC
DC390B	0.4 in (9 mm)	1	AUTO BLADE LOCK	10	120	0-49296-11188-5

UTILITY KNIVES & BLADES

ALUMINIST[®] MAGAZINE

PREMIUM GRADE STEEL | JAPANESE-STYLE TEMPERING | MULTIFACET SHARPENING

These stylish and highly functional knives were designed with key features to make them ideal for every task. With the automatic blade feed systems and the removable magazine, blade trim and reload is quick and convenient. The rugged die-cast aluminum handles with embedded elastomer non-slip grips provide superior in-hand control.



ALUMINIST[®] MAGAZINE

- Die-cast aluminum cutter knives
- Automatic blade feed
- Removable magazine holds up to 5 blades of the 1 in (25 mm) blades or 6 of the 0.7 in (18 mm) blades



Removable magazine for fast reloads





ITEM CODE			BLADE LOCK	CASE	MASTER CARTON	UPC
ACM-700C	1 in (25 mm)	3	DUAL BLADE LOCK	4	40	0-49296-01843-6
ACM-700SC	1 in (25 mm) (non-segmented)		AUTO BLADE LOCK			0-49296-01926-6
ACM-500C	0.7 in (18 mm)		AUTO BLADE LOCK	20	0-49296-01928-0	

UTILITY KNIVES & BLADES

ROCK HARD ALUMINIST®

- Die-cast aluminum 1 in (25 mm) blade cutter knives
- In-handle blade storage
- Available in Auto-Blade Lock or Dial Blade Lock mechanisms





ITEM CODE			BLADE LOCK	CASE	MASTER CARTON	UPC
AC-700B	1 in (25 mm)	3	AUTO BLADE LOCK	4	40	0-49296-01813-9
AC-700S						0-49296-01828-3
AC-701S			DIAL BLADE LOCK			0-49296-01829-0
AC-701R						0-49296-01814-6

HEAVY DUTY ALUMINIST®

- Die-cast aluminum 0.7 in (18 mm) blade cutter knives
- In-handle spare blade storage
- Available in Automatic Blade Lock or Dial Blade Lock mechanisms





ITEM CODE			BLADE LOCK	CASE	MASTER CARTON	UPC
AC-500B	0.7 in (18 mm)	3	AUTO BLADE LOCK	4	40	0-49296-01887-0
AC-501R			DIAL BLADE LOCK			0-49296-01888-7

HEAVY DUTY ALUMINIST® FIN

- Die-cast aluminum 0.7 in (18 mm) blade cutter knife with contoured handle
- Multi-function fin
- Dial Blade Lock mechanism



ITEM CODE			BLADE LOCK	CASE	MASTER CARTON	UPC
AC-521R	0.7 in (18 mm)	1	DIAL BLADE LOCK	4	40	0-49296-01899-3

UTILITY KNIVES & BLADES

DRIVER CUTTER™

PREMIUM GRADE STEEL JAPANESE-STYLE TEMPERING MULTISTEP SHARPENING

Super Hard Tip™

Unique line of knives that feature ultra-hard 0.04 in (1mm) thick tempered blade sleeves with multi-function “driver” tips.

3.5 times stronger than standard models, the Driver Cutter™ blade sleeves conform to strict JIS standards for screwdriver tip hardness so they will easily drive standard head screws. Additionally, Driver Cutter knives can also handle other common tasks including lifting can lids, and opening boxes without having to extend the knife blade.



Driving standard-head screws.



Prying off can lids



Opening cartons, scoring thick cardboard



DRIVER CUTTER™

L
0.7 in (18 mm)



- 0.7 in (18 mm) cutter knives
- Super Hard Tip
- Elastomer grip and in-handle spare blade storage
- Equipped with 3 Razar Black Blade™
- Available with Automatic Blade Lock or Dial Blade Lock mechanisms



DC-560

DC-561



ITEM CODE			BLADE LOCK	CASE	MASTER CARTON	UPC
DC-560	0.7 in (18 mm)	3	AUTO BLADE LOCK	10	120	0-49296-01992-1
DC-561			DIAL BLADE LOCK			0-49296-01993-8

UTILITY KNIVES & BLADES

Tajima Comfort-Grip Knives
GRI® SERIES

PREMIUM GRADE STEEL JAPANESE STYLE TEMPERING MULTIPLETTER SHARPENING



Comfortable elastomer grips are ribbed for non-slip performance

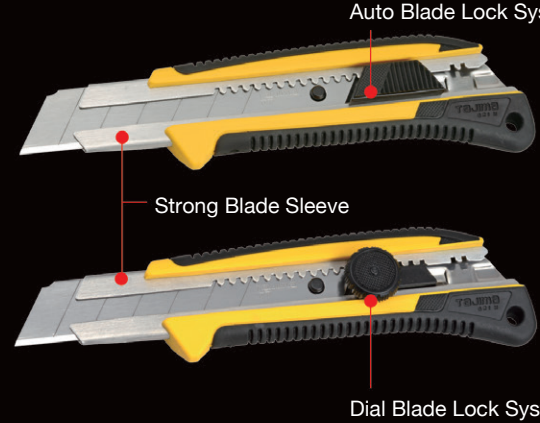

Auto Blade Lock System

Strong Blade Sleeve



Dial Blade Lock System

ROCK HARD GRI® H 1 in (25 mm)



- Extra heavy-duty 1 in (25 mm) blade cutter knives with comfort grip
- Equipped with a Rock Hard Blade™
- Available in Automatic Blade Lock or Dial Blade Lock mechanisms





ITEM CODE			BLADE LOCK	CASE	MASTER CARTON	UPC
LC-660	1 in (25 mm)	1	AUTO BLADE LOCK	10	120	0-49296-01580-0
LC-661			DIAL BLADE LOCK			0-49296-01581-7

HEAVY DUTY GRI® L 0.7 in (18 mm)



- Heavy-Duty 0.7 in (18 mm) blade cutter knives with comfort grip
- Equipped with an Endura-Blade™
- Available in Automatic Blade Lock or Dial Blade Lock mechanisms



ITEM CODE			BLADE LOCK	CASE	MASTER CARTON	UPC
LC-560	0.7 in (18 mm)	1	AUTO BLADE LOCK	10	120	0-49296-01561-9
LC-561			DIAL BLADE LOCK			0-49296-01564-0

PRECISION CRAFT GRI® A 0.4 in (9 mm)



- Precision 0.4 in (9 mm) blade cutter knife with comfort grip
- Equipped with an Endura-Blade™
- Slide Lock blade locking mechanism



ITEM CODE			BLADE LOCK	CASE	MASTER CARTON	UPC
LC-360	0.4 in (9 mm)	1	SLIDE BLADE LOCK	10	120	0-49296-01582-4

UTILITY KNIVES & BLADES

STRONG-J GRIP™

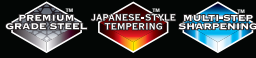

Powerful Two-Handed Cutter
Handle ensures a straight cut, even when pressing with both hands.

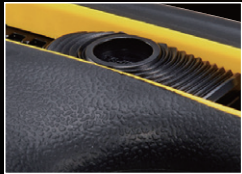

The slider button is recessed below the gripping surface, minimizing the risk of auto lock release even when gripping with both hands.



0.04 in (1.0 mm) thick tempered stainless steel blade sleeve. This stainless steel sleeve supports and protects the blade point.



Blade Lock that holds 55 lbs (25 kg) of locking force for extreme cutting.



STRONG-J GRIP™



- Extra heavy-duty 0.9 in (22 mm) blade cutter knife
- Enable to use for peeling off the caulking material
- Suitable for cutting thick materials such as carpet, thermal insulation, plasterboard, and plywoods



J 10 J-Power Blades included
0.9 in (22 mm)



ITEM CODE			BLADE LOCK	CASE	MASTER CARTON	UPC
DC-690	0.9 in (22 mm)	10	AUTO BLADE LOCK	6	24	0-49296-11250-9

UTILITY KNIVES & BLADES

ROCK HARD SERIES

Effective against any sheet materials, plywood and other thick materials, using a 0.7 mm x 25 mm Tajima firm blade.



Razar Black Blade™



Grip form

The new handle is designed specifically for comfort and ease of use.

In-handle blade storage

Pre-loaded with two spare blades located in the convenient in-handle storage compartment.



AUTO LOCK DFC670N-R1

SUPER HARD TIP™

The extended blade sleeve holds blade sturdily, preventing blade breakage.

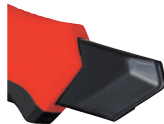

A blade-sliding mechanism built for precision



DIAL LOCK DFC671N-R1

Slider movements can be felt in hand when moving back and forward. Compared to existing slider feature, this tool gives more precise feeling from the grip to hand.

Tempered blade sleeve with fin end

At 1.0 mm thick, the hardness of this sleeve is more than double that of existing stainless steel blade sleeves. This sleeve's iconic FIN design is not only durable, it offers additional functionality in opening and prying.

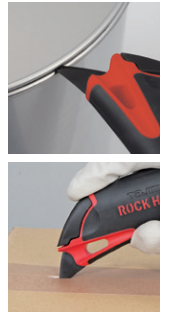

ROCK HARD FIN™





DFC670N-R1



DFC671N-R1

- Tempered blade sleeve; the hardness level is 2x more than existing stainless steel sleeves
- Durable super hard tip
- Iconic FIN design provides added functionality in opening and prying



ITEM CODE			BLADE LOCK	CASE	MASTER CARTON	UPC
DFC670N-R1	1 in (25 mm)	2	AUTO BLADE LOCK	6	60	0-49296-11251-6
DFC671N-R1			DIAL BLADE LOCK			0-49296-11252-3

UTILITY KNIVES & BLADES

ROCK HARD®

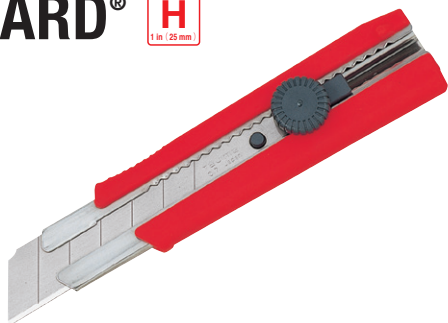

- Extra heavy-duty 1 in (25 mm) blade cutter knife with thick elastomer grip
- Equipped with a Rock Hard Blade™



ITEM CODE			BLADE LOCK	CASE	MASTER CARTON	UPC
LC-650	1 in (25 mm)	1	DIAL BLADE LOCK	6	60	0-49296-02087-3

LC-620



- Extra heavy-duty 0.9 in (22 mm) blade cutter knife
- In-handle spare blade storage
- Equipped with 3 Endura-Blade™
- Auto-Lock blade locking mechanism



ITEM CODE			BLADE LOCK	CASE	MASTER CARTON	UPC
LC-620	0.9 in (22 mm)	3	AUTO BLADE LOCK	10	120	0-49296-02154-2

LC-520 / 521



- 0.7 in (18 mm) blade cutter knives
- Ergonomic grip surrounds an extra-thick blade sleeve
- In-handle spare blade storage
- Equipped with an 3 Razar Black Blade™
- Available in Auto-Lock or Dial Lock blade locking mechanism

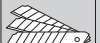

ITEM CODE			BLADE LOCK	CASE	MASTER CARTON	UPC
LC-520	0.7 in (18 mm)	3	AUTO BLADE LOCK	10	120	0-49296-11093-2
LC-521			DIAL BLADE LOCK			0-49296-11094-9

UTILITY KNIVES & BLADES

LC-500 / 501



LC-500





LC-501

- Heavy-duty 0.7 in (18 mm) blade cutter knives
- In-handle blade storage
- Equipped with 3 Endura-Blade™
- Available in Auto-Lock or Dial Lock blade locking mechanism
- 40 piece displays available in 4-color



LC501-A40



ITEM CODE			BLADE LOCK	CASE LC500-C40	MASTER CARTON	UPC
LC-500	0.7 in (18 mm)	3	AUTO BLADE LOCK	10	120	0-49296-02010-1
LC500-C40				1 set (40)	3 sets (120)	0-49296-02147-4
LC-501			DIAL BLADE LOCK	10	120	0-49296-02134-4
LC501-A40				1 set (40)	3 sets (120)	0-49296-02146-7

PRECISION CRAFT STAINLESS STEEL





LC-301



LC-302

- 0.4 in (9 mm) blade cutter knives
- Sleek and lightweight
- Equipped with 3 Endura-Blade™
- Available in Slide Lock or Dial Lock blade locking mechanism



ITEM CODE			BLADE LOCK	CASE	MASTER CARTON	UPC
LC-301	0.4 in (9 mm)	3	SLIDE BLADE LOCK	10	120	0-49296-02004-0
LC-302			DIAL BLADE LOCK			0-49296-02006-4

PRECISION CRAFT





LC-303

- 0.4 in (9 mm) blade cutter knife
- Slim handle with in-handle blade storage
- Equipped with 3 Endura-Blade™
- Slide Lock blade locking mechanism
- 60 piece displays available in 3-color



LC303-D60



ITEM CODE			BLADE LOCK	CASE	MASTER CARTON	UPC
LC-303	0.4 in (9 mm)	3	SLIDE BLADE LOCK	10	120	0-49296-02007-1
LC303-D60				1 set (60)	4 sets (240)	0-49296-02152-8

SCRAPERS

SCRAPE-RITE™



Use with a hammer for chisel-like tasks



Smoothing the floor surface

Scraping off wall paper

Protective blade guard









Spring-loaded blade clamp



SCRAPE-RITE™

- Reversible blade scrapers
- Die-cast aluminum heads
- Reinforced shafts



ITEM CODE			FEATURES	CASE	MASTER CARTON	UPC
SCR-H1200	1 in (25 mm)	3	48 in (1200 mm) handle	4	8	0-49296-01996-9
SCR-L600	0.7 in (18 mm)		24 in (600 mm) handle		24	0-49296-01614-2
SCR-L300			12 in (300 mm) handle		0-49296-01613-5	
SCR-L200			8 in (200 mm) handle		0-49296-01612-8	
LCB-65S	1 in (25 mm)	10	SOLID ROCK HARD BLADE™	 10  100	 50  500	0-49296-01995-2
LCB-50S	0.7 in (18 mm)		SOLID ENDURA-BLADE™		 120  1,200	0-49296-11072-7

PULL-STROKE SAWS



PULL-STROKE SAWS

JAPAN PULL™ BLADES



Japanese tempered SK-95 premium steel blade with triple cutting edge teeth and Fluoro-Coat™ blade coating.



Japanese tempered SK-95 premium steel blade with triple cutting edge teeth.



Japanese Tempered

Unique steel hardening process that results in blades with exceptional durability and cutting performance.



Impulse Hardened

Spot hardening of blade teeth to further enhance the cutting performance while not reducing blade flexibility.



Fluoro-Coat™

Unique fluorine-based coating that reduces friction and protects against rust and corrosion.

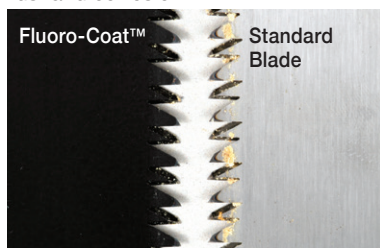

*After cutting through 40 mm thick branches, 100 times.



Alternating 4 tall, 4 short teeth pattern that results in cutting edge sharpness that lasts 3 times longer.

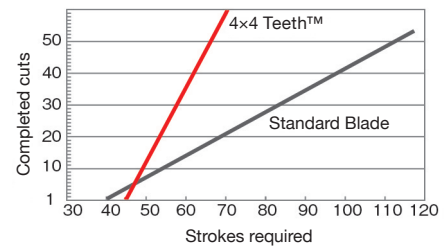

Extra rigid blade for superior tracking and cutting control.

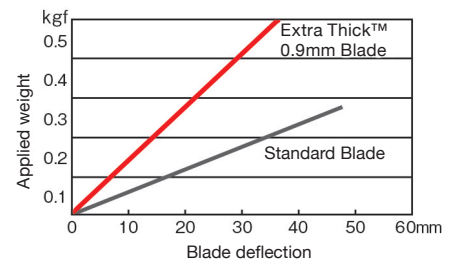

PULL-STROKE SAWS

JAPAN PULL™ R-SAW



						MATERIAL SUITABILITY INDEX				
①	MGB-300FB 	STANDARD CUT	11.8 in (300 mm)	0.08 in (2.15 mm)	13 TPI	0.03 in (0.7 mm)	★	★★	★★★	★★
②	GNB-300 		10.2 in (265 mm)	0.07 in (1.75 mm)	16 TPI	0.02 in (0.6 mm) / 0.04 in (0.9 mm)	★	★★	★★★	★★
③	GNB-265 	FINE CUT	9.1 in (230 mm)	0.06 in (1.40 mm)	19 TPI	0.02 in (0.5 mm) / 0.03 in (0.7 mm)	★★	★	★★	★
④	GNB-265ST 		9.8 in (250 mm)	0.05 in (1.20 mm)	21 TPI	0.02 in (0.4 mm) / 0.02 in (0.55 mm)	★★	★★	★	★
⑤	GNB-250 	MICRO FINE CUT	9.1 in (230 mm)	0.05 in (1.20 mm)	21 TPI	0.02 in (0.4 mm) / 0.02 in (0.55 mm)	★★	★★	★	★
⑥	GNB-230 		9.1 in (230 mm)	0.05 in (1.20 mm)	21 TPI	0.02 in (0.4 mm) / 0.02 in (0.55 mm)	★★	★★	★	★

★★★ Best ★★ Better ★ Good

PULL-STROKE SAWS

MAGNUM® 300



Premium carpenter saw featuring a 13 TPI Fluoro-Coat blade. The oversized handle with an embedded elastomer grip combines style and functionality for greater ease of use. A protective blade guard which covers the entire blade is included for added safety.



MAGNUM® 300



- Premium carpenter saw featuring a 13 TPI Fluoro-Coat Blade™
- The oversized handle with an embedded elastomer grip combines style and functionality for greater ease of use
- A protective blade guard which covers the entire blade is included for added safety



ITEM CODE					CASE	MASTER CARTON	UPC
MG-300FB	11.8 in (300 mm)	0.08 in (2.15 mm)	13 TPI	0.03 in (0.7 mm) / 0.05 in (1.15 mm)	4	12	0-49296-01883-2

MAGNUM® 300 BLADE



- Premium-grade 13 TPI Fluoro-Coat Blade™
- Exclusive replacement for the Magnum 300 saw



ITEM CODE					CASE	MASTER CARTON	UPC
MGB-300FB	11.8 in (300 mm)	0.08 in (2.15 mm)	13 TPI	0.03 in (0.7 mm) / 0.05 in (1.15 mm)	2	120	0-49296-01884-9





PULL-STROKE SAWS

JAPAN PULL™ 265R



- Precision pull-stroke saw
- Quick-release blade retainer
- Traditional straight handle with elastomer grip







ITEM CODE					CASE	MASTER CARTON	UPC
JPR-265R	10.2 in (265 mm)	0.07 in (1.75 mm)	16 TPI	0.02 in (0.6 mm) / 0.04 in (0.9 mm)	6	24	0-49296-01971-6

JAPAN PULL™ 265 SHORT



- Precision pull-stroke saw
- Quick-release blade retainer
- Short straight handle with tubular elastomer grip
- Total length: 16 in (406 mm)



ITEM CODE					CASE	MASTER CARTON	UPC
JPR-265ST	9.1 in (230 mm)	0.07 in (1.75 mm)	16 TPI	0.02 in (0.6 mm) / 0.04 in (0.9 mm)	6	24	0-49296-11102-1

PULL-STROKE SAWS

JAPAN PULL™ 300 AND 265



JPR-300



JPR-265



- Precision pull-stroke saw
- Quick-release blade retainer
- Curved handle with elastomer non-slip grip

ITEM CODE					CASE	MASTER CARTON	UPC
JPR-300	11.8 in (300 mm)	0.08 in (2.15 mm)	13 TPI	0.03 in (0.7 mm) / 0.05 in (1.15 mm)	6	60	0-49296-01944-0
JPR-265	10.2 in (265 mm)	0.07 in (1.75 mm)	16 TPI	0.02 in (0.6 mm) / 0.04 in (0.9 mm)		24 (4 sets)	0-49296-01943-3

JAPAN PULL™ SET



- SET INCLUDES:
- 1 pc Elastomer-wrapped straight handle
 - 1 pc 16 TPI blade
 - 1 pc 19 TPI blade
 - 1 pc Tri-fold canvas carrying case

ITEM CODE					CASE	MASTER CARTON	UPC
JPR-SET	GNB-265	10.2 in (265 mm)	0.07 in (1.75 mm)	16 TPI	6 sets	24	0-49296-11005-5
	GNB-250	9.8 in (250 mm)	0.05 in (1.40 mm)	19 TPI			

PULL-STROKE SAWS

JAPAN PULL™ BLADES



- Premium-grade SK-95 blades
- Impulse hardened triple-edge cutting teeth

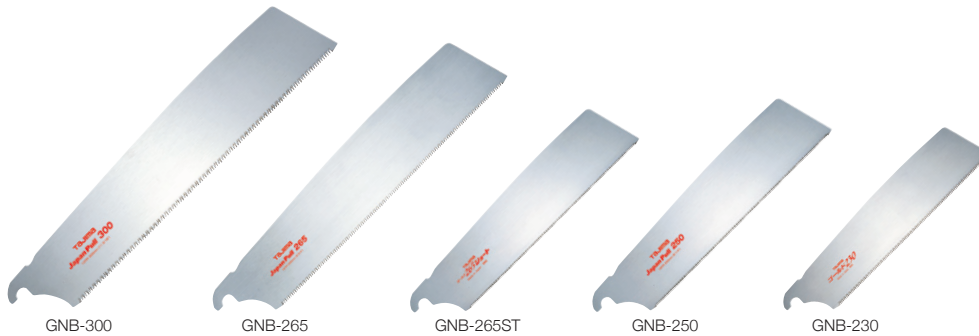

ITEM CODE					CASE	MASTER CARTON	UPC
GNB-300	11.8 in (300 mm)	0.08 in (2.15 mm)	13 TPI	0.03 in (0.7 mm) / 0.05 in (1.15 mm)	3	120	0-49296-06009-1
GNB-265	10.2 in (265 mm)	0.07 in (1.75 mm)	16 TPI	0.02 in (0.6 mm) / 0.04 in (0.9 mm)			0-49296-06003-9
GNB-265ST	9.1 in (230 mm)						0-49296-11103-8
GNB-250	9.8 in (250 mm)	0.06 in (1.40 mm)	19 TPI	0.02 in (0.5 mm) / 0.03 in (0.7 mm)			0-49296-06001-5
GNB-230	9.1 in (230 mm)	0.05 in (1.20 mm)	21 TPI	0.02 in (0.4 mm) / 0.02 in (0.55 mm)			0-49296-11104-5

PULL-STROKE SAWS

JAPAN PULL™ G-SAW

All handles are interchangeable with all blades.



SAW						MATERIAL SUITABILITY INDEX											
① ALB-A240	AGGRESSIVE CUT	0.1 in (3.0 mm)	9 TPI	0.04 in (0.9 mm) / 0.05 in (1.2 mm)	★★	★★	★★	★	★★	★★	★★						
② ALB-A270												10.6 in (270 mm)	★★	★★	★	★★	★★
③ GKB-G210												8.3 in (210 mm)	★★	★★	★	★★	★★
④ GKB-G240												9.4 in (240 mm)	★★	★★	★	★★	★★

★★★ Best ★★ Better ★ Good

PULL-STROKE SAWS

ALUMINIST® G-SAW™



- Tapered 9 TPI Fluoro-Coat blades
- Die-cast aluminum handle with elastomer grip
- Available in fixed-blade with sheath or folding handle models



ITEM CODE					CASE	MASTER CARTON	UPC
ALSA-A270	10.6 in (270 mm)	0.1 in (3.0 mm)	9 TPI	0.04 in (0.9 mm) / 0.05 in (1.2 mm)	4	24	0-49296-01746-0
ALOR-A240	9.4 in (240 mm)						0-49296-01741-5

G-SAW™ 240 AND 210



- Multi-purpose 9 TPI blades
- Folding handle
- Elastomer grip



ITEM CODE					CASE	MASTER CARTON	UPC
GK-G240	9.4 in (240 mm)	0.1 in (3.0 mm)	9 TPI	0.03 in (0.7 mm) / 0.04 in (1.0 mm)	6	60	0-49296-01589-3
GK-G210	8.3 in (210 mm)						0-49296-01575-6

PULL-STROKE SAWS

G-SAW™ REPLACEMENT BLADES

- Premium-grade 9 TPI tapered blades with triple edge cutting teeth
- Available with Fluoro-Coat Blade™ or standard blade coatings



ITEM CODE					CASE	MASTER CARTON	UPC
ALB-A270	10.6 in (270 mm)	0.1 in (3.0 mm)	9 TPI	0.04 in (0.9 mm) / 0.05 in (1.2 mm)	2	120	0-49296-01750-7
ALB-A240	9.4 in (240 mm)						0-49296-01749-1
GKB-G240	9.4 in (240 mm)			0.03 in (0.7 mm) / 0.04 in (1.0 mm)	3		0-49296-01590-9
GKB-G210	8.3 in (210 mm)						0-49296-01576-3

LAYOUT TOOLS

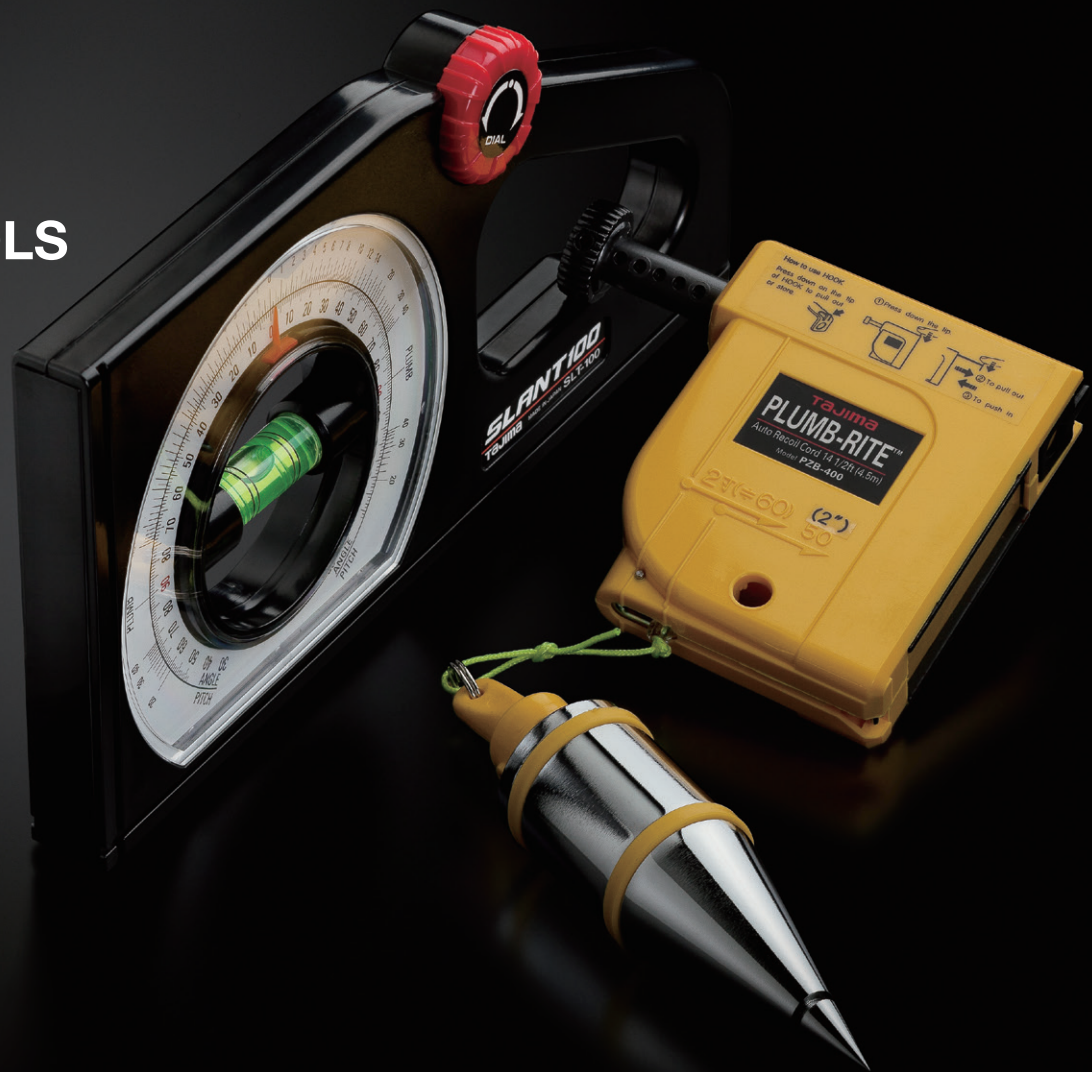

LAYOUT TOOLS





PLUMB ALIGNMENT AND CENTERING TOOLS

Quickly and easily attaches to most any surface. Setting pin for wood or drywall, strong magnet for steel surfaces, hook onto nail or studs.

PLUMB-RITE® 400GP

- All-in-one plumb alignment and centering tool
- Self-retracting line
- Elastomer-wrapped heavy-duty case
- Reinforced setting pin head
- 14 oz / 400 g quick-stabilizing bob





ITEM CODE			CASE	MASTER CARTON	UPC
PZB-400GP	14 oz. / 400 g	14.8 ft (4.5 m)	6	24 (4 sets)	0-49296-05638-4

PLUMB-RITE® 400

- All-in-one plumb alignment and centering tool
- Self-retracting line
- 14 oz / 400 g quick-stabilizing bob



ITEM CODE			CASE	MASTER CARTON	UPC
PZB-400	14 oz. / 400 g	14.8 ft (4.5 m)	6	24 (4 sets)	0-49296-05412-0

LAYOUT TOOLS

PLUMB-RITE® 300



- All-in-one plumb alignment and centering tool
- Self-retracting line
- 10 oz / 300 g quick-stabilizing bob



ITEM CODE			CASE	MASTER CARTON	UPC
PZB-300	10 oz. / 300 g	10 ft (3 m)	6	24 (4 sets)	0-49296-05506-6

PLUMB-RITE® QUICK-STABILIZING BOBS

- Quick-stabilizing bobs (within 6 seconds)



ITEM CODE		FEATURES	CASE	MASTER CARTON	UPC
PQB600	21 oz. / 600 g	QUICK-STABILIZING	6	24	0-49296-05426-7
PQB400	14 oz. / 400 g				0-49296-05425-0
PQB300	10 oz. / 300 g				0-49296-05424-3
PQB200	7 oz. / 200 g				0-49296-05423-6

PLUMB-RITE® BRAIDED PLUMB LINE

- Premium braided nylon/polyester line for use with Plumb-Rite layout tools



ITEM CODE		CASE	MASTER CARTON	UPC
PC-ITOL	0.04 in (0.9 mm) x 49 ft (15 m)	10	100	0-49296-05431-1

LAYOUT TOOLS

SLANT™ SERIES

Fast and reliable tools to measure, set, or replicate a pitch or angle.

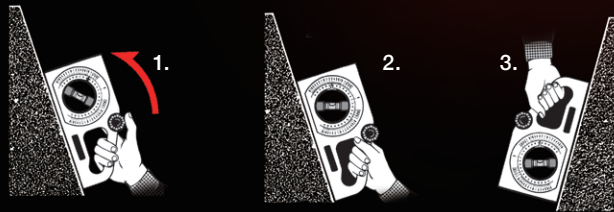

TO MEASURE AN ANGLE OR PITCH

1. Place the bottom of the pitch / angle meter flush with the surface to be measured.
2. Rotate the thumb-screw knob until the bubble in the vial is centered between the alignment lines then read the angle or pitch calibration mark at the index pointer.
3. Invert the pitch / angle meter to measure a downward slope.

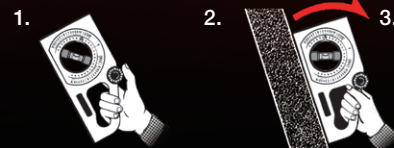

TO SET AN ANGLE OR PITCH

1. Rotate the thumb-screw knob until the index pointer is positioned at the desired angle or pitch calibration mark.
2. Place the bottom of the pitch / angle meter flush with the surface to be set.
3. Rotate together until the bubble in the vial is centered between the alignment lines.

SLANT™ AL200 / 100



SLT-AL200M



SLT-100

- Rotating dual-scale angle meter to single-handedly measure, set, or replicate a pitch or angle
- Durable aluminum frame
- Magnet on bottom allows for hands-free use with compatible surfaces



- Rotating dual-scale angle meter to single-handedly measure, set, or replicate a pitch or angle

ITEM CODE		ACCURACY	CASE	MASTER CARTON	UPC
SLT-AL200M	130° - 0 - 130°	±1°	6	36	0-49296-06585-0
SLT-100					0-49296-04083-3

INDEX

ITEM CODE	Page		Page		Page
A					
AC-500B	57, 61	CNV-FSP600	20, 22	GNB-250	71, 75
AC-501R	57, 61	CNV-J900PL2	20, 25	GNB-265	71, 75
AC-521R	57, 61	CNV-J900SP	20, 25	GNB-265ST	71, 75
AC-700B	56, 61	CNVBSP3W550	20, 23	GNB-300	71, 75
AC-700S	56, 61	CR101S-0	10, 14	GP-16BW	28, 29, 37
AC-701R	56, 61	CR201R-PR	10, 12	GP-25BW	28, 29, 37
AC-701S	56, 61	CR201W-P	10, 12	GP-30BW	28, 29, 37
ACM-500C	57, 60	CR202B-P	10, 13	GS-16BW	28, 29, 32
ACM-700C	56, 60	CR301JF	10, 13	GS-16/5MBW	28, 29, 32
ACM-700SC	56, 60	CR401S	10, 12	GS-25BW	28, 29, 32
ALB-A240	76, 78	CR403S	10, 11	GS-25/7.5MBW	28, 29, 32
ALB-A270	76, 78	CR503S	10, 11	GS-C16BW	28, 29, 33
ALOR-A240	77	CR604S	10, 11	GS-C16/5MBW	28, 29, 33
ALSA-A270	77	D		GS-MC16BW	29, 34
AZS-ROP	36	DC390B	57, 59	GS-MC16/5MBW	29, 34
C		DC540N	57, 58	GS-SC16BW	29, 34
CB39RBH	57	DC-560	57, 62	GS-SC16/5MBW	29, 34
CB50C	57	DC-561	57, 62	GSSF-16BW	28, 29, 33
CB50RBC	57	DC660N	56, 59	GSSF-16/5MBW	28, 29, 33
CB65C	56	DC661N	56, 59	GSSF-25BW	28, 29, 33
CB65RBC	56	DC690	56, 64	GSSF-25/7.5MBW	28, 29, 33
CNV-100LT	20, 26	DFC560N	57, 58	GT165JS	52
CNV-100PL2	20, 25	DFC561N	57, 58	GTB165JS	52
CNV-100RS	20, 23	DFC670N-R1	56, 65	H	
CNV-100SP	20, 25	DFC671N-R1	56, 65	HKB-50B	54
CNV-100SP18	20, 24	G		HKB-5B	54
CNV-100SP26	20, 24	G-16/5MBW	28, 29, 37	HL-16/5MBW	28, 29, 38
CNV-900RS	20, 23	G-16BW	28, 29, 37	HL-16BW	28, 29, 38
CNV-900SP18	20, 24	G-25/7.5MBW	28, 29, 37	HL-25/7.5MBW	28, 29, 38
CNV-900SP26	20, 24	G-25BW	28, 29, 37	HL-25BW	28, 29, 38
CNVBP-BN	23	G-30BW	28, 29, 37	HL-30BW	28, 29, 38
CNVBP-SN	23	G-33/10MBW	28, 29, 37	I	
CNVBP-SP	23	G-5.5MBW	28, 29, 37	IR101S-0	18
CNV-DSP26	20, 21	G-6BW	28, 29, 37	J	
CNV-FFC	22	G-7.5MBW	28, 29, 37	JPR-265	74
CNV-FSN	22	GKB-G210	76, 78	JPR-265R	73
CNV-FSNL	22	GKB-G240	76, 78	JPR-265ST	73
CNV-FSP	22	GK-G210	77	JPR-300	74
CNV-FSP26-600	20, 22	GK-G240	77	JPR-SET	74
		GNB-230	71, 75		

INDEX

ITEM CODE	Page				
L		M			
LC-301	57, 67	M21-WAT	18	PLC3-DW900	17
LC-302	57, 67	MG-300FB	72	PLC3-DW2700	17
LC-303	57, 67	MGB-300FB	71,72	PL-ITOL	10, 14
LC303-D60	67	P		PL-ITO3L	10, 14
LC-360	57, 63	PC-ITOL	81	PL-ITOLL	10, 14
LC-500	57, 67	PLC2-B300	17	PL-ITOS	10, 14
LC500-C40	67	PLC2-B900	17	PQB200	81
LC-501	57, 67	PLC2-B2700	17	PQB300	81
LC501-A40	67	PLC2-FB300	17	PQB400	81
LC-520	57, 66	PLC2-FB900	17	PQB600	81
LC-521	57, 66	PLC2-FB2700	17	PSB2-180	18
LC-560	57, 63	PLC2-FG300	17	PS-ITOS	18
LC-561	57, 63	PLC2-FG900	17	PSS2-180	18
LC-620	56, 66	PLC2-FG2700	17	PZB-300	81
LC-650	56, 66	PLC2-FP300	17	PZB-400	80
LC-660	56, 63	PLC2-FP900	17	PZB-400GP	80
LC-661	56, 63	PLC2-FP2700	17	S	
LCB-30	57	PLC2-FY300	17	SCR-H1200	56, 68
LCB-30-50	57	PLC2-FY900	17	SCR-L200	56, 57, 68
LCB-30RB	57	PLC2-FY2700	17	SCR-L300	56, 57, 68
LCB-50	57	PLC2-R300	17	SCR-L600	56, 57, 68
LCB-50-50	57	PLC2-R900	17	SF-BHLD	35
LCB-50D	57	PLC2-R2700	17	SF-BHLD-BK	35
LCB-50RB	57	PLC2-W300	17	SF-CHLD	35
LCB-50RB-50	57	PLC2-W900	17	SF-LOOP	36
LCB-50S	57, 68	PLC2-W2700	17	SF-MHLD	36
LCB-62	56	PLC2-Y300	17	SF-MTHLD	36
LCB-65	56	PLC2-Y900	17	SF-THLD	35
LCB-65-20	56	PLC2-Y2700	17	SLT-100	82
LCB-65RB	56	PLC3-BK300	17	SLT-AL200M	82
LCB-65S	56, 68	PLC3-BK900	17	SS-10BW	28, 29, 31
LE-E502D-SP	40, 41	PLC3-BK2700	17	SS-16BW	28, 29, 31
LE-F501D	40, 43	PLC3-DB300	17	SS-16/5MBW	28, 29, 31
LE-F502D	40, 42	PLC3-DB900	17	SS-25BW	28, 29, 31
LE-M501D	40, 43	PLC3-DB2700	17	SS-25/7.5BMW	28, 29, 31
LE-SF351D	40, 45	PLC3-DR300	17	SSSF-16BW	28, 29, 31
LE-SF352D	40, 45	PLC3-DR900	17	SSSF-16/5MBW	28, 29, 31
LE-SF501D-SP	40, 44	PLC3-DR2700	17	SSSF-25BW	28, 29, 31
LE-ZP3730	40, 45	PLC3-DW300	17	SSSF-25/7.5MBW	28, 29, 31

INDEX

ITEM CODE	Page
-----------	------

T

TAJ-CP10	15
TAJ-CSDR	15
TAJ-EH09	15
TAJ-G009	15
TAJ-GS09	15
TAJ-HN09	15
TAJ-HNDR	15
TAJ-LL09	15
TAJ-LS09	15
TAJ-LSDR	15
TAJ-NTSBTS	15
TAJ-PTDR	15
TAJ-SPDR	15
TBK180-H45	47
TBK180-V30	47
TBY-S130C	49
TBY-S130S	49
TBY-SH180	51
TMK-KV45	48
TMKB-C50	48
TBYD-180	50

V

VR-101R	54, 55
VR-102B	54, 55
VR-103	54, 55
VRB2-100B	54
VRB2-50B	54
VRB2-5B	54

memo

Tajima

Founded in 1909 as a manufacturer of steel and woven measuring tapes, TJM Design Corporation now produces over 1,000 premium-grade hand tools under the **Tajima** brand. A multinational organization with global production facilities, TJM Design Corporation continues its commitment to excellence in the design, selection of materials, production and quality control processes that govern the manufacture of its tools. And all TJM Design Corporation staff are dedicated to ensuring that the function, quality, shape and design of **Tajima** tools fulfills the desires and expectations of the end user. As a result, **Tajima** brand tools are recognized worldwide as offering exceptional feature and function at a high level of quality rarely seen in today's industry.



Tajima

TAJIMA TOOL CORPORATION

3510 Torrance Blvd., Suite 301, Torrance, CA 90503

www.tajimatool.com

For warranty info visit : www.tajimatool.com/warranty/

For general inquiry : info@tajimatool.com

© 2023 Tajima Tool Corporation



www.tajimatool.com



[@tajimatoolusa](https://www.instagram.com/tajimatoolusa)



Actual products may vary in color and material from photographs.

X-ON Electronics

Largest Supplier of Electrical and Electronic Components

Click to view similar products for [Enclosures, Boxes & Cases](#) category:

Click to view products by [TAJIMA](#) manufacturer:

Other Similar products are found below :

[M-10-PLATED](#) [60221-01](#) [M17-L-PLN](#) [M-21-PLATED](#) [63310-01-000](#) [6711GSKT](#) [90026-501-000](#) [PS36-200](#) [120-407](#) [138-PLAIN](#) [144011](#)
[EAS-500 \(BLACK ANO\)](#) [2062750000](#) [KAB3421](#) [A0645271](#) [1928952](#) [2106-IR](#) [2792057](#) [2906241](#) [2906254](#) [2907981](#) [H5031](#) [CU-284](#)
[MDC-532-PLAIN-ALUM](#) [B137](#) [5400TN](#) [UNC 2-4-6 PLAIN](#) [462-0020E](#) [0542100012](#) [043853](#) [103031](#) [11416P](#) [KR8-315](#) [UM-SE-A73-R](#)
[BK](#) [2202158](#) [TUF 55 25 100 ME](#) [332-907](#) [4122](#) [52213](#) [24560-245](#) [736-409](#) [144012](#) [61-9480.6](#) [134573](#) [M18-L-PLTD](#) [73095-510-000](#)
[CNM-0303 Black](#) [S3A-453213-S](#) [ALUG702RD040-IR](#) [07.6370000](#) [P/4.2](#)