

SWITCHCRAFT CATALOG PART NUMBER

S/C CATALOG PART NO. DMD3FRA111

S/C CATALOG PART NO. DMD4FRA111

S/C CATALOG PART NO. DMD5FRA111

S/C CATALOG PART NO. DMD6FRA111

S/C CATALOG PART NO. DMD7FRA111

S/C CATALOG PART NO. DMD8FRA111

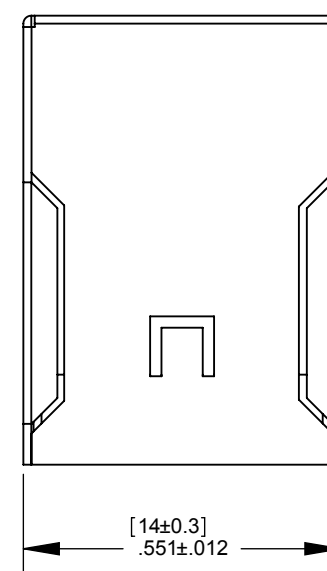
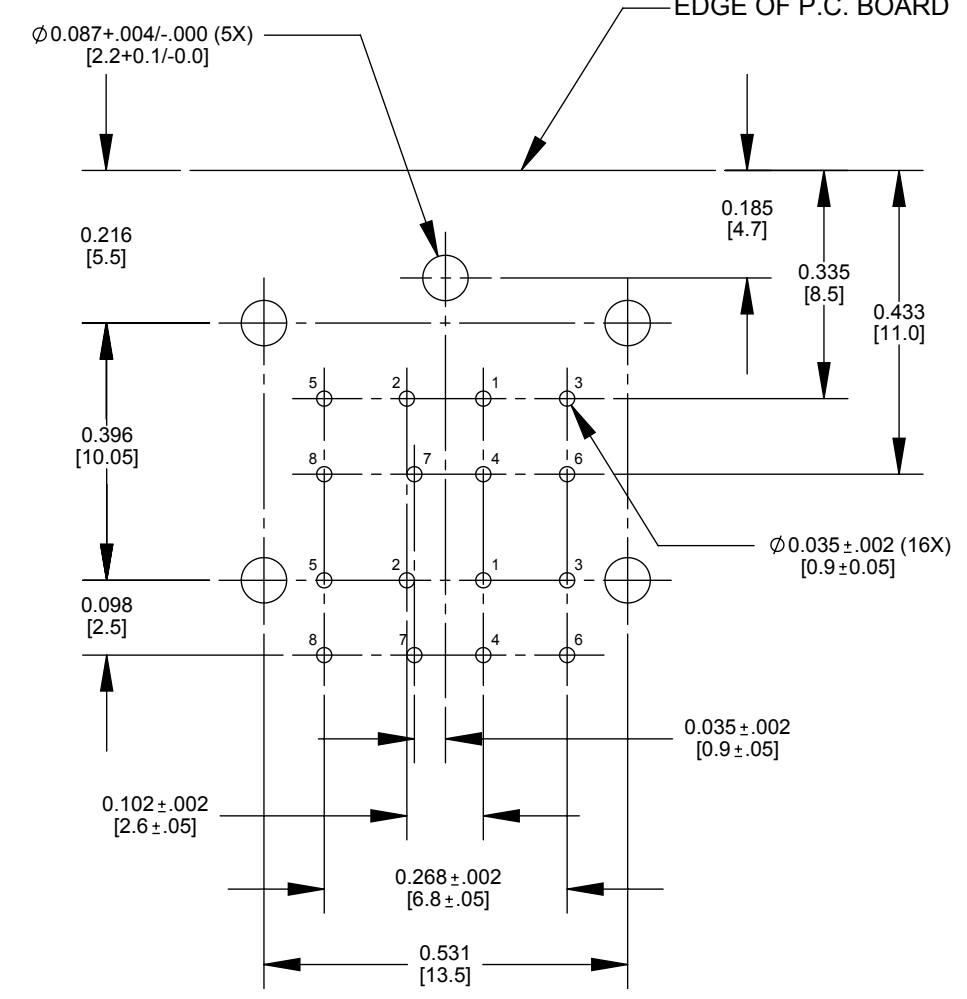
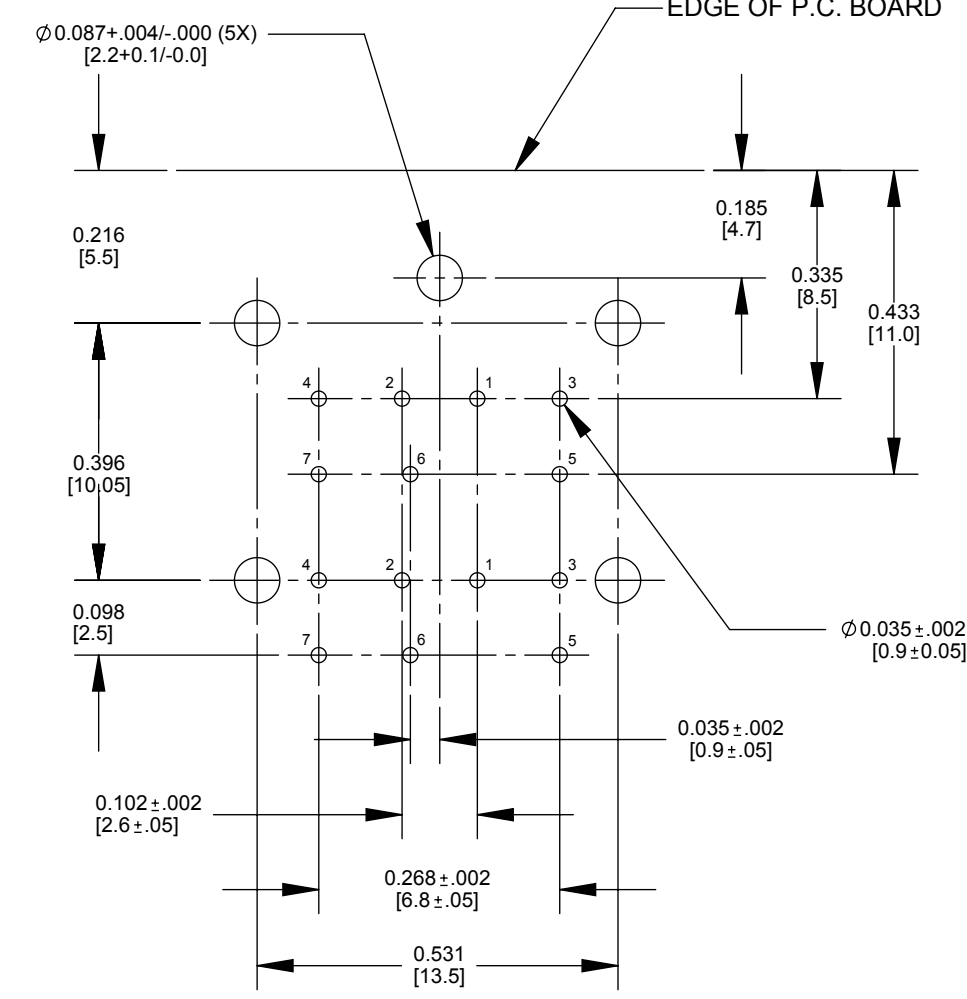
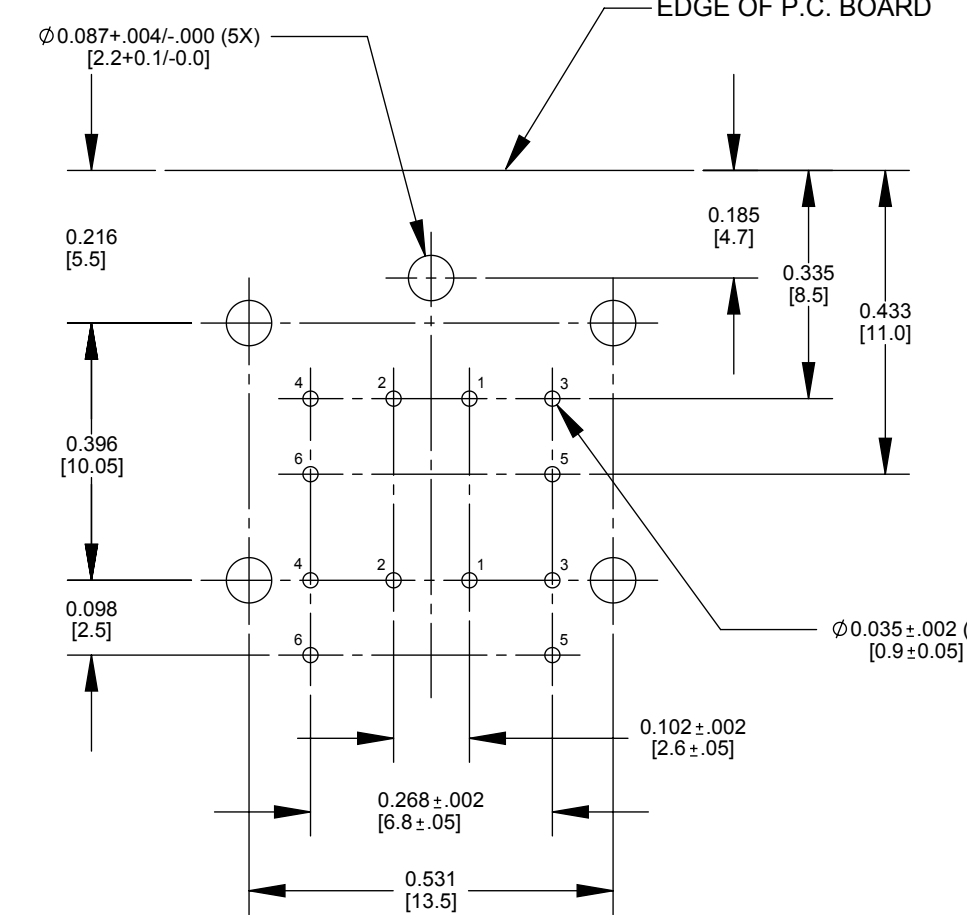
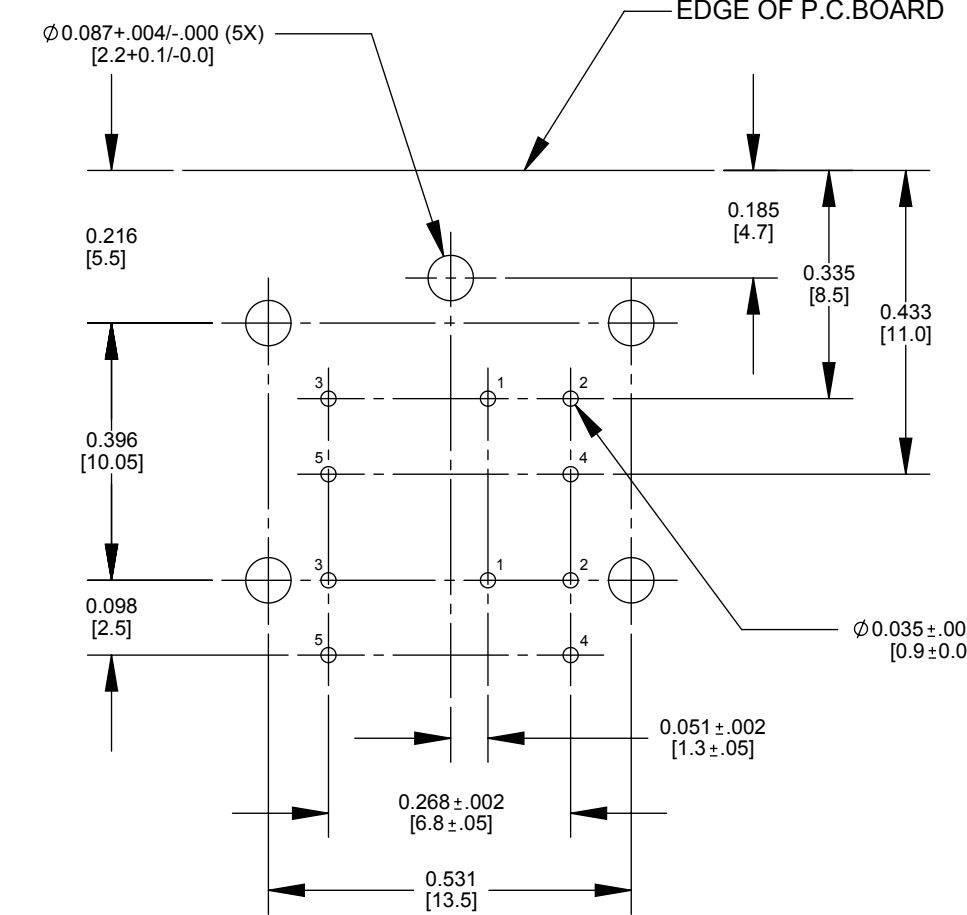
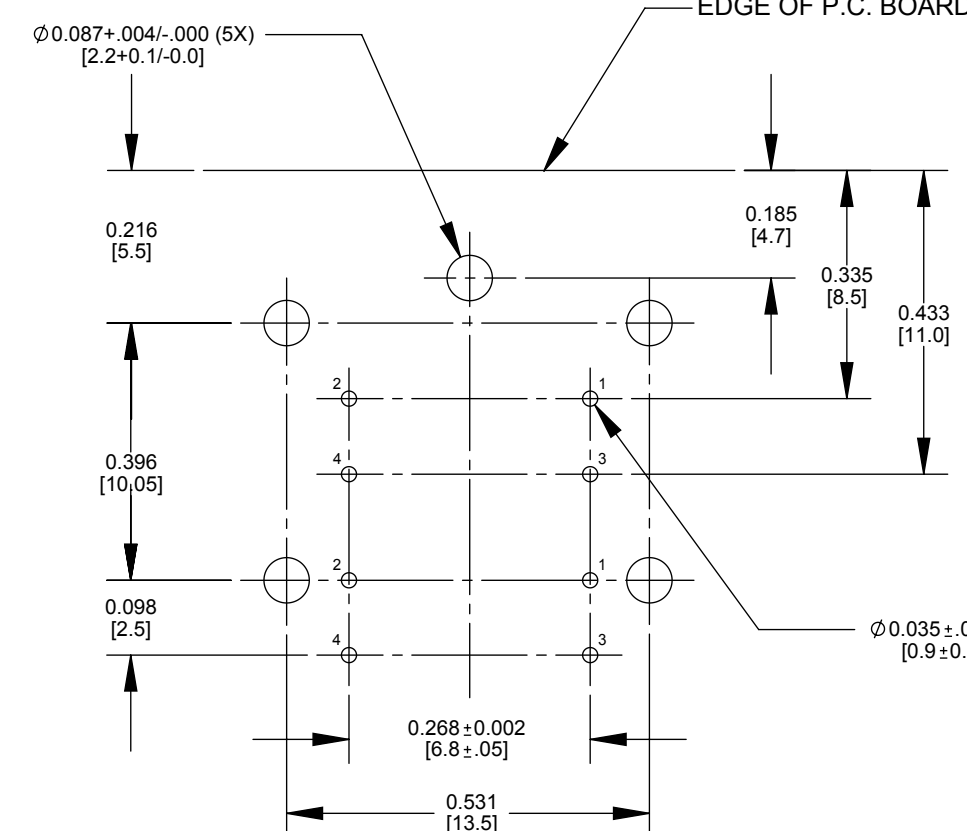
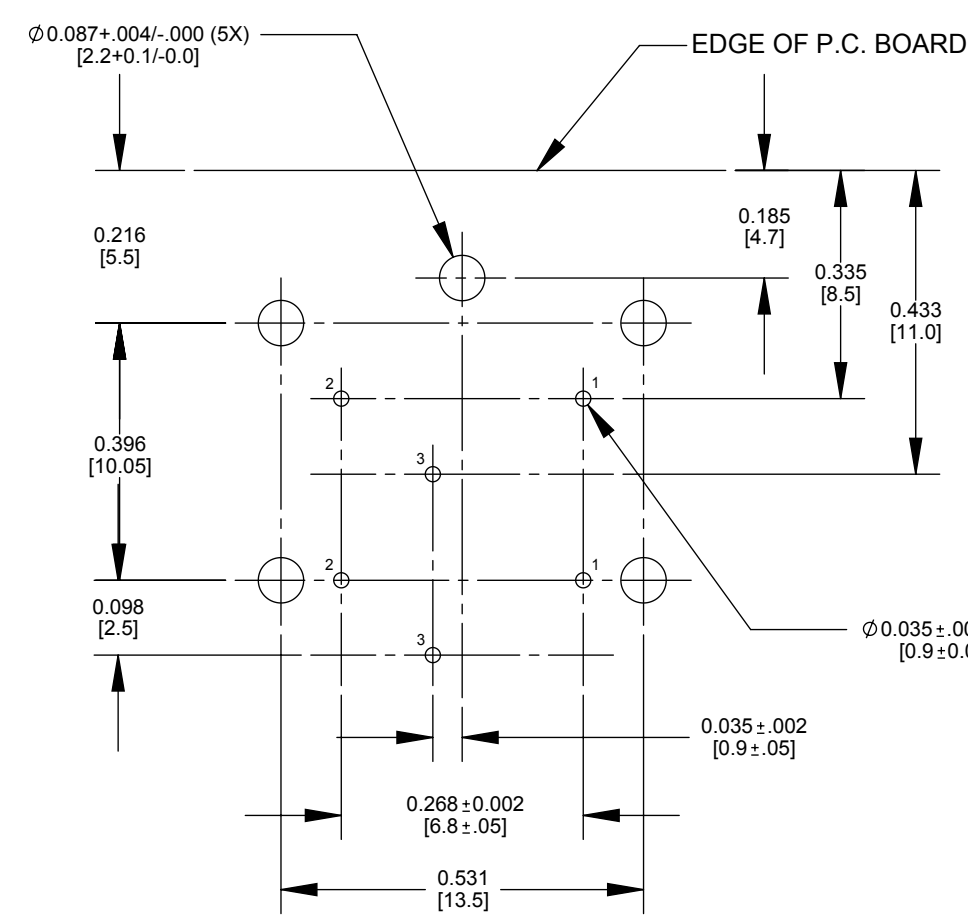
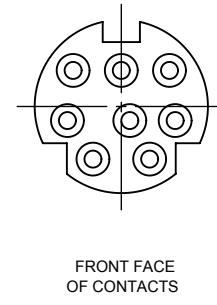
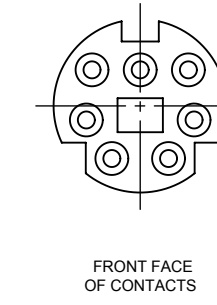
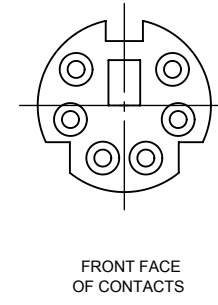
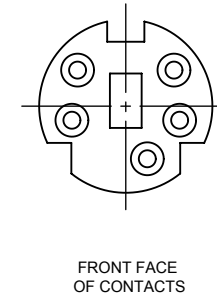
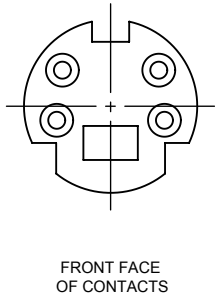
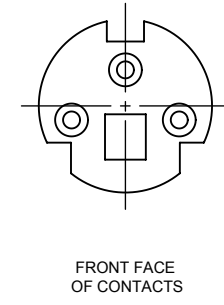

MATERIALS:
 BODY : BLACK, MOLDED THERMOPLASTIC, UL-94V-0
 COVER : COPPER ALLOY, TIN PLATED
 CONTACTS : COPPER ALLOY, SILVER PLATED

SPECIFICATION :

- CURRENT CARRYING CAPACITY:
 A) AC: 100V 1A MAX.
 B) DC: 12V 3A MAX.
- CONTACT RESISTANCE: 30m Ohms MAX.
- INSULATION RESISTANCE:
 BETWEEN ANY ADJACENT OPEN CONTACTS SHALL NOT BE LESS THEN 100m Ohms AS SPECIFIED BELOW, WITH A 250V DC INSULATION RESISTANCE TEST.
- DIELECTRIC STRENGTH :
 A POTENTIAL OF 250V AC rms 50/60Hz SHALL BE APPLIED BETWEEN ANY OPEN CONTACTS FOR ONE MINUTE WITHOUT BREAKDOWN.
- INSERTION FORCE : 10 lbs. [4.5kg] MAX.
- WITHDRAWAL FORCE : 1.8 - 7.7lbs. [0.8 - 3.5 kg]

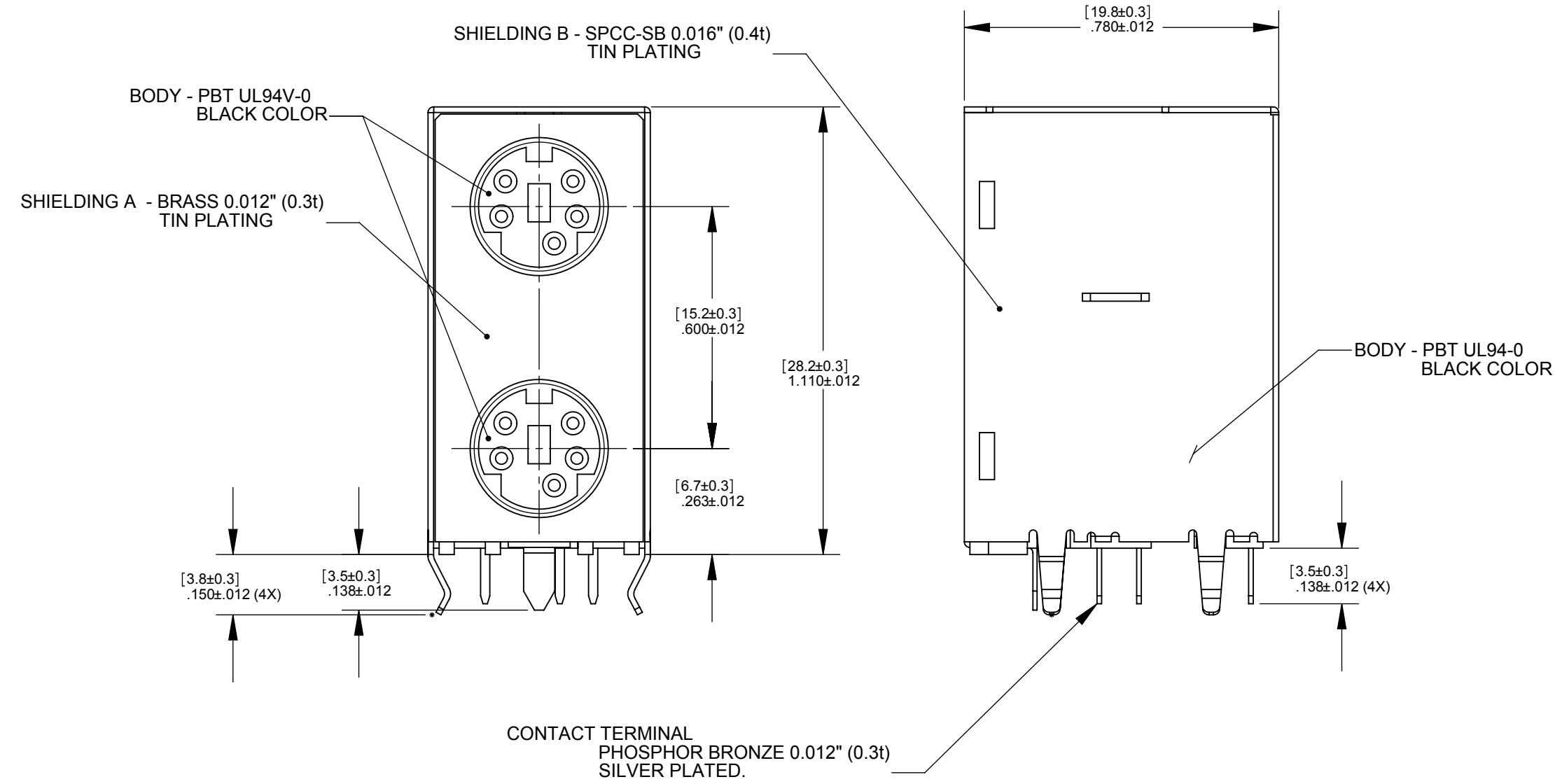

PART NUMBER	PART REV
DMD3FRA111	A
DMD4FRA111	A
DMD5FRA111	A
DMD6FRA111	A
DMD7FRA111	A
DMD8FRA111	A

NOTE:
 1. ALL DIMENSIONS SHOWN ARE FOR REFERENCE ONLY.

CUSTOMER DRAWING

UNLESS OTHERWISE SPECIFIED		STAR SYMBOL DENOTES CRITICAL DIMENSION	
1. ALL DIMENSIONS IN INCHES - TWO PLACE DECIMALS ± 0.01 - THREE PLACE DECIMALS ± 0.005 - ANGLES ± 1° - ALL DIA. CONCENTRIC WITHIN 0.005 T.I.R.		THIS DRAWING DESCRIBES A DESIGN CONSIDERED PROPRIETARY IN NATURE, DEVELOPED AND MANUFACTURED BY SWITCHCRAFT INC. AND IS RELEASED ON A CONFIDENTIAL BASIS FOR IDENTIFICATION PURPOSES ONLY.	
FINISH	SPEC No.	FIRST USED ON	SCALE
DATE DRAWN	BY	CHKD	APVD
A	22476	10-12-00	JL RB
REV	ECO NUMBER	DATE	BY
REVISIONS			
DO NOT SCALE DRAWING			
NAME		MINI DIN, DUAL	
PART No.		DMD_FRA111	
SHEET		1 OF 1	
REV		A	

X-ON Electronics

Largest Supplier of Electrical and Electronic Components

Click to view similar products for [Circular DIN Connectors](#) category:

Click to view products by [Switchcraft](#) manufacturer:

Other Similar products are found below :

[75-190222-09G](#) [FRCIR030FP-36-10P-F80](#) [FRCIR030R-36-7P-F80](#) [FRCIR06F-20-15S-F80](#) [FRCIR06R-20-27S](#) [8R3006A18M0033](#) [PT05A-14-5SX](#) [GTC01A-22-28P](#) [PT05A1832SW](#) [PT05A2041SX](#) [GTC030-20-27PW-LC](#) [GTC030A-20-33S](#) [GTC06R20-22P-025-LC](#) [1210500311](#) [1210503216](#) [D38999/42FB35BN](#) [D38999/42FD05PN](#) [D38999/42FE35AN](#) [D38999/46WD35AN](#) [D38999/46WJ19BA](#) [D38999/46WJ19BN](#) [D38999/46WJ19SA-L/C](#) [D38999/46WJ19SN-L/C](#) [D38999/46WJ29BN](#) [D38999/46WJ35BA](#) [D38999/47WD35PB](#) [D38999/47WJ29SA](#) [MS3100R20-22S](#) [MS3100R20-22SW](#) [MS3100R20-27S](#) [MS3100R20-27SW](#) [MS3101R20-7S](#) [MS3102R18-1PZ](#) [MS310314S-5P](#) [MS3114F10-6P](#) [MS3116E8-4SW](#) [MS3122E10-6PW](#) [MS3456W28-21PZ-LC](#) [C18213N21](#) [CA06COME24-11PB](#) [CA06EW20-29PBF80](#) [CA06R22-14S](#) [CA3100E14S-9PB](#) [CA3100E16S-8PBF80](#) [CA3100E18-1SBF80A176](#) [CA3100E18-6PB](#) [CA3100E20-7SB-F80-A176](#) [CA3100E32-15PB](#) [CA3100E32-15SB](#) [CA3100E32-17PB](#)