

Silicon Epitaxial Planar Switching Diode

Features

- Small package
- Low forward voltage
- Fast reverse recovery time

Equivalent Circuit

3.Cathode1、 Cathode2

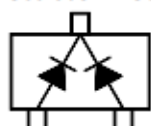

1.Anode1 2.Anode2

SOT-23

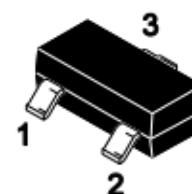

1.Anode1 2.Anode2
3.Cathode1、 Cathode2

Marking Code : A61

Absolute Maximum Ratings ($T_A=25^\circ\text{C}$)

Parameter	Symbol	Value	Unit
Maximum Repetitive Reverse Voltage	V_{RRM}	85	V
Reverse Voltage	V_R	80	V
Average Rectified Forward Current	$I_{F(AV)}$	100	mA
Maximum Peak Forward Current	I_{FM}	300	mA
Non-Repetitive Peak Forward Surge Current	I_{FSM}	1	A
Maximum Power Dissipation	P_D	150	mW
Junction Temperature	T_J	150	$^\circ\text{C}$
Storage Temperature Range	T_{STG}	-55 to +150	$^\circ\text{C}$

Electrical Characteristics ($T_A=25^\circ\text{C}$)

Parameter	Symbol	Typ.	Max.	Unit
Forward Voltage at $I_F = 1 \text{ mA}$ at $I_F = 10 \text{ mA}$ at $I_F = 100 \text{ mA}$	V_F	0.6 0.7 0.9	-- -- 1.2	V
Reverse Current at $V_R = 70 \text{ V}$	I_R	--	1	μA
Typical Junction Capacitance at $V_R = 0 \text{ V}$, $f = 1 \text{ MHz}$	C_j	--	4	pF
Maximum Reverse Recovery Time at $I_F = 10 \text{ mA}$, $V_R = 6 \text{ V}$, $I_{RR} = 0.1 \times I_R$, $R_L = 100 \Omega$	T_{rr}	--	4	nS

Typical Characteristic Curves

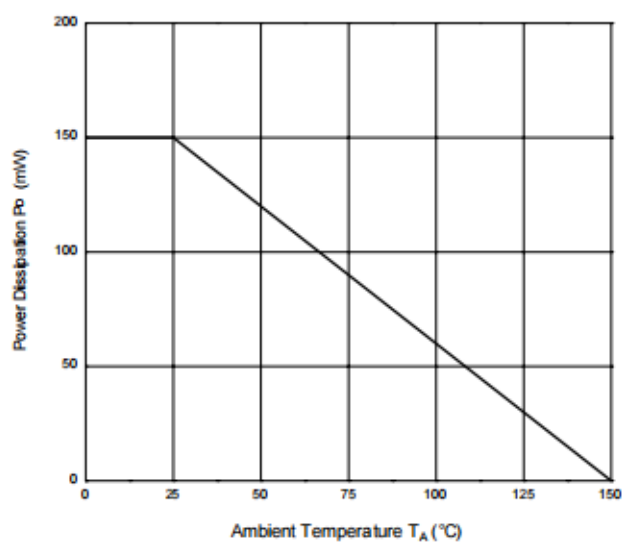
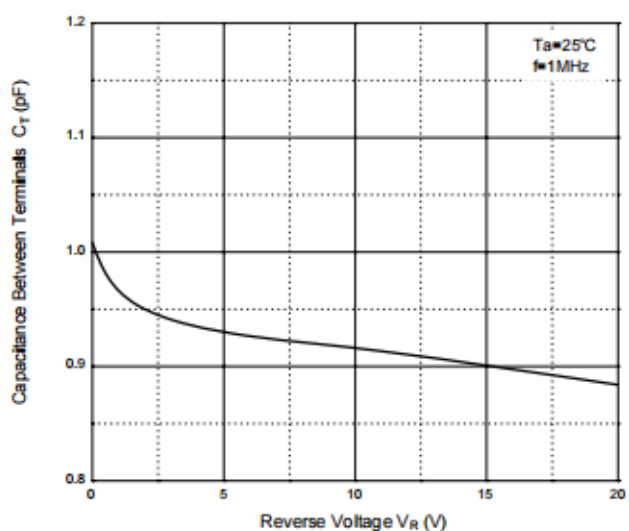
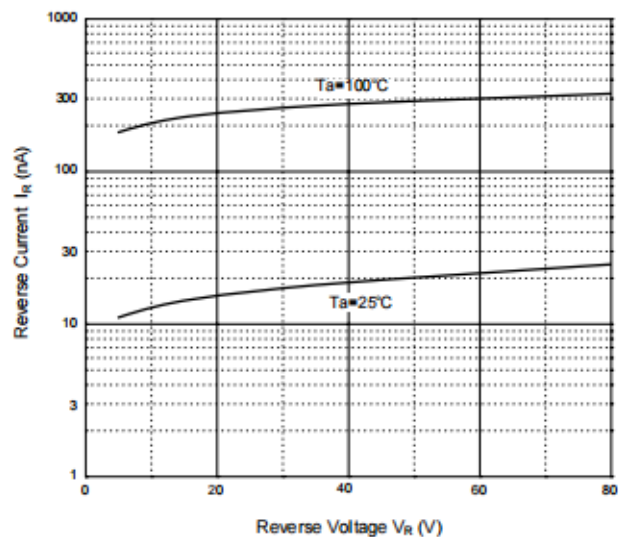
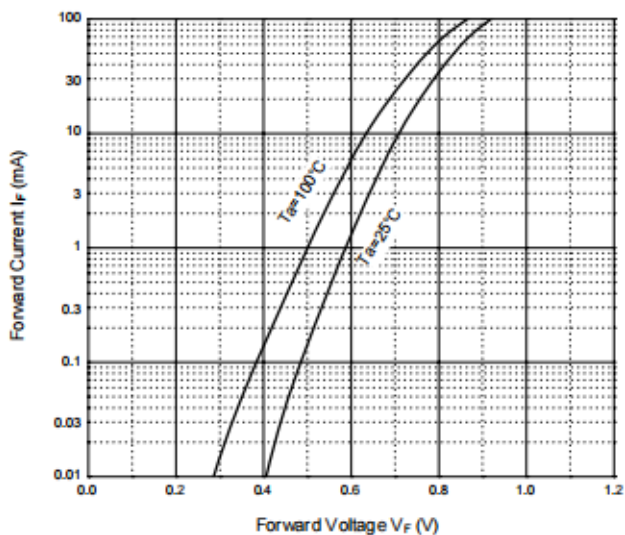

Package Outline

SOT-23

Dimensions in mm

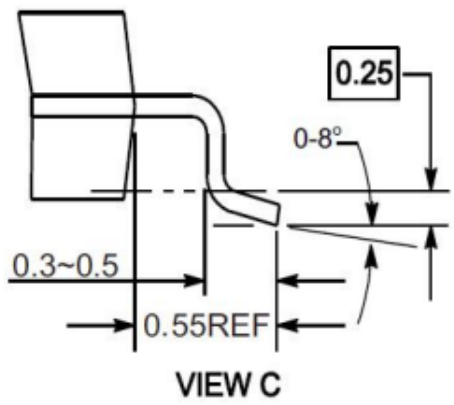
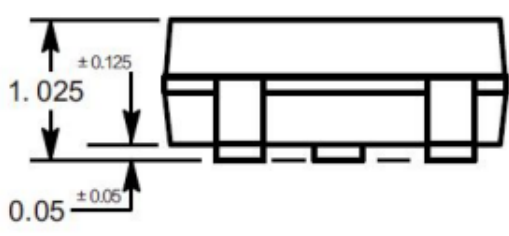
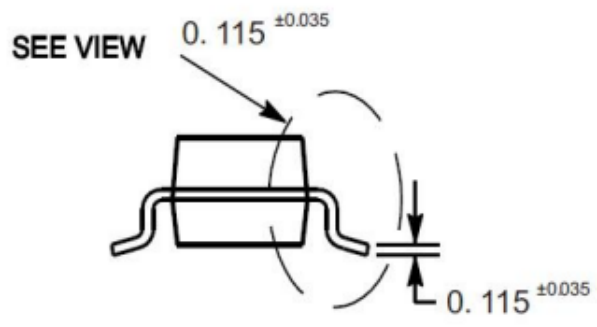
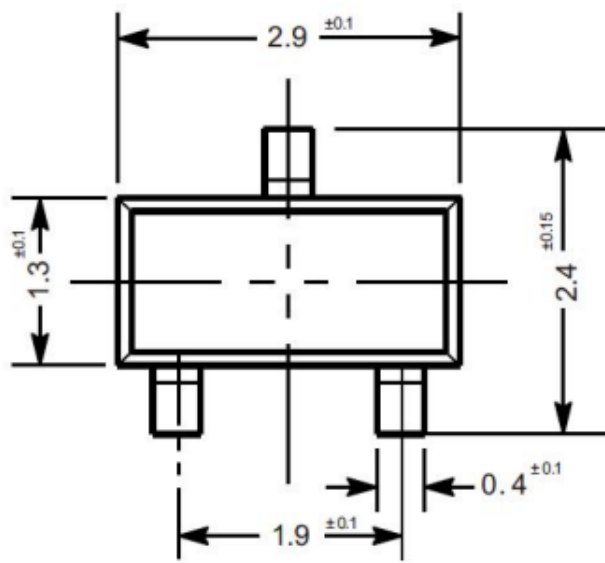

X-ON Electronics

Largest Supplier of Electrical and Electronic Components

Click to view similar products for [Diodes - General Purpose, Power, Switching category:](#)

Click to view products by [SLKORMICRO manufacturer:](#)

Other Similar products are found below :

[RD0306T-TL-H](#) [RD0506T-TL-H](#) [DCD010-TB-E](#) [DSE010-TR-E](#) [NTE6244](#) [FC903-TR-E](#) [1N4449](#) [1N456A](#) [1N914BTR](#) [RFUH20TB3S](#)
[BAW75-TAP](#) [JAN1N3600](#) [BAV70HDW-7](#) [BAS28 TR](#) [1SS388-TP](#) [SI-A1125](#) [UF3G](#) [SHV-06JNS-Q](#) [2CL75A](#) [MCL4148PF](#) [1SS226,LF\(T](#)
[1SS352\(TPH3,F\)](#) [1SS306\(TE85L.F\)](#) [KDS122-RTK/P](#) [KDS135-RTK/PU](#) [DB107](#) [S-LBAS16HT1G](#) [P1200M](#) [KDS160E-RTL/P](#) [DB106S](#)
[DB207](#) [DB157](#) [DB155](#) [DB206](#) [2CL74](#) [DB105](#) [DB156S](#) [DB206S](#) [DB156](#) [BAV199](#) [1SS181,LF\(T](#) [CRG09A,LXGQ](#) [CRG09A,LQ\(M](#) [DB106](#)
[SDUR1530](#) [S2KTR](#) [S2MTR](#) [GL1M](#) [CD4148WSP](#) [CD4148WTP](#)