

**SURFACE MOUNT GPP
TRANSIENT VOLTAGE SUPPRESSOR
400 WATT PEAK POWER 1.0 WATTS STEADY STATE**

FEATURES

- * Plastic package has underwriters laboratory
- * Glass passivated chip construction
- * 400 watt surge capability at 1ms
- * Excellent clamping capability
- * Low zener impedance
- * Fast response time

MAXIMUM RATINGS AND ELECTRICAL CHARACTERISTICS

Ratings at 25 °C ambient temperature unless otherwise specified.
Single phase, half wave, 60 Hz, resistive or inductive load,
For capacitive load, derate current by 20%.



DO-214AC

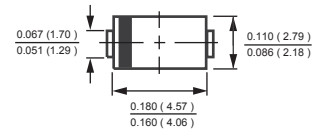

Dimensions in inches and (millimeters)

MAXIMUM RATINGS (@ TA=25 °C unless otherwise noted)

RATINGS	SYMBOL	VALUE	UNITS
Peak Power Dissipation at TA = 25°C, TP = 1mS (Note 1)	PPPM	Minimum 400	W
Peak Pulse Current with a 10/1000uS waveform (Note 1, Fig.3)	IPPM	SEE TABLE 1	A
Steady State Power Dissipation at TL = 75°C lead length, .375" (9.5 mm) (Note 2)	PM(AV)	1.0	W
Peak Forward Surge Current, 8.3ms single half sine wave-superimposed on rated load (JEDEC METHOD) (Note 3)	IFSM	40	A
Maximum Instantaneous Forward Voltage @25A for unidirectional only (Note 5)	VF	3.5/6.5	V
Operating and Storage Temperature Range	TJ, TSTG	-55 to + 150	°C

- NOTES : 1. Non-repetitive current pulse, per Fig.3 and derated above TA = 25°C per Fig.2.
2. Mounted on 0.2 X 0.2" (5.0 X 5.0mm) copper pad to each terminal.
3. Measured on 8.3mS single half Sine-Wave or equivalent wave, duty cycle = 4 pulses per minute maximum.
4. "Fully ROHS compliant", "100% Sn plating (Pb-free)".
5. VF = 3.5V max. for devices of V(BR) ≤ 200V and VF = 6.5V max. for devices of V(BR) ≥ 200V.

RATING AND CHARACTERISTIC CURVES (P4FMAJ6.8 THRU P4FMAJ400CA)

FIG. 1 - PEAK PULSE POWER RATING CURVE

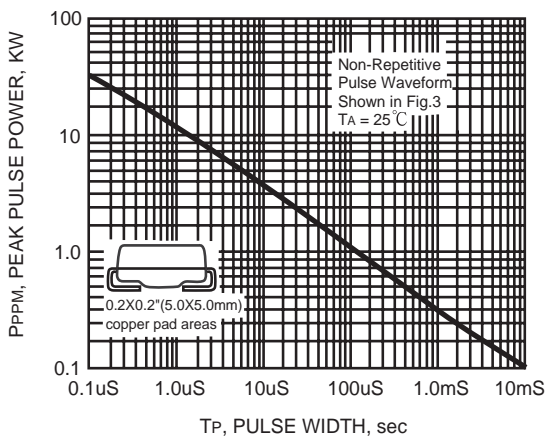

FIG. 2 - PULSE DERATING CURVE

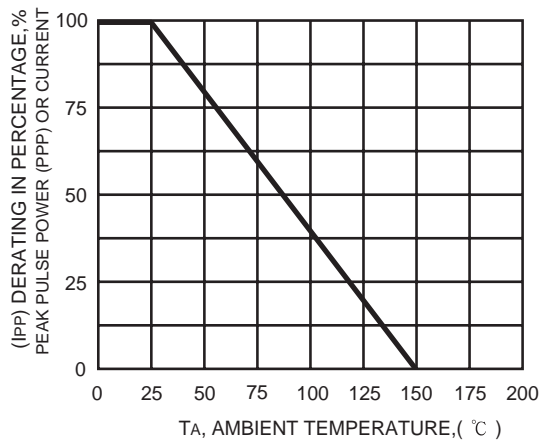

FIG. 3 - PULSE WAVEFORM

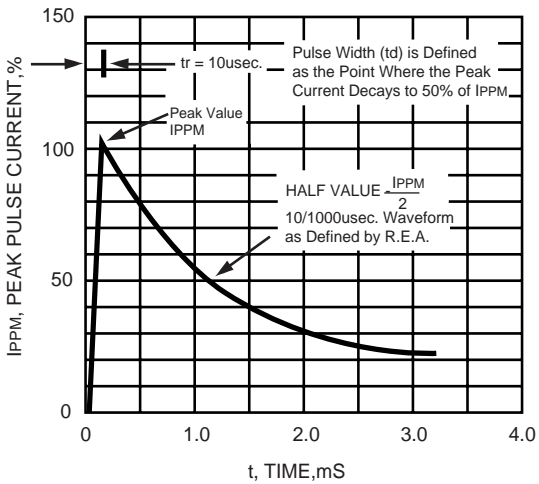
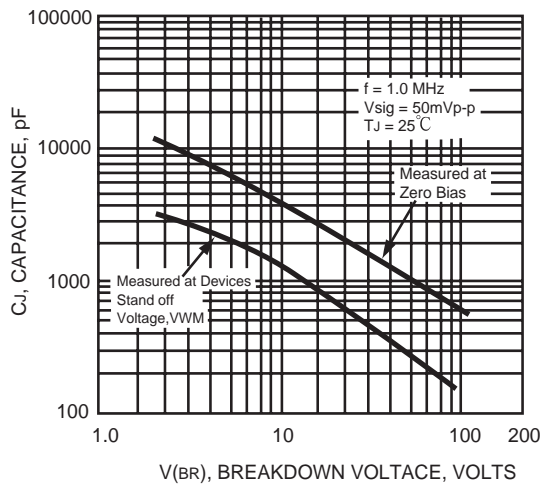

FIG. 4 - TYPICAL JUNCTION CAPACITANCE



RATING AND CHARACTERISTIC CURVES (P4FMAJ6.8 THRU P4FMAJ400CA)

FIG. 5 - STEADY STATE POWER DERATING CURVE

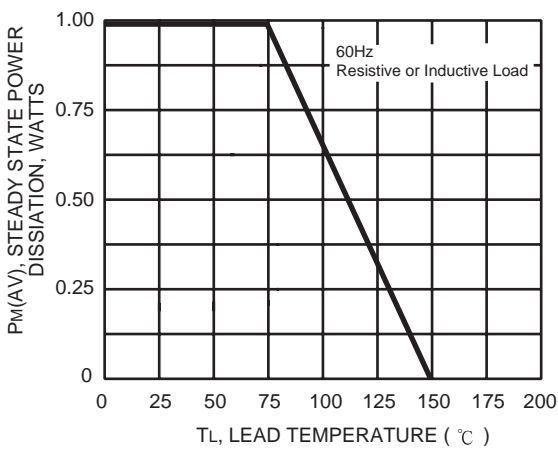

FIG. 6 - MAXIMUM NON-REPETITIVE FORWARD SURGE CURRENT UNIDIRECTIONAL

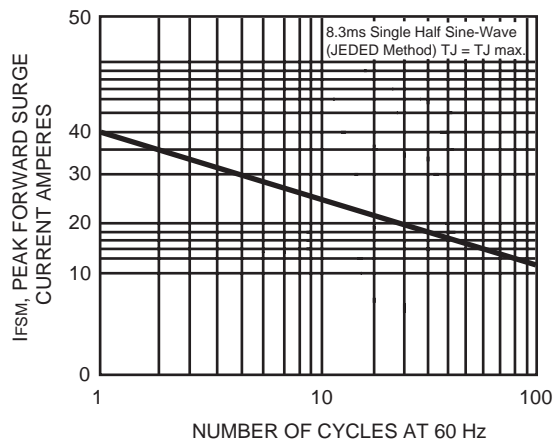
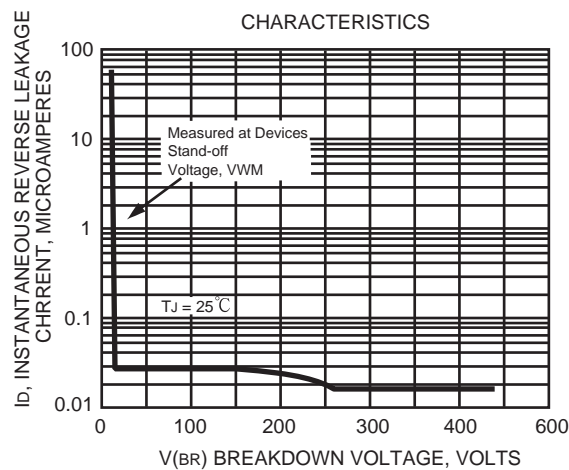

FIG. 7 - TYPICAL REVERSE LEAKAGE CHARACTERISTICS



TRANSIENT VOLTAGE SUPPRESSORS

400W SERIES TVS DIODES / DO-214AC (CASE 2) 400W

TYPE	Breakdown Voltage		@I _T (mA)	Reverse Stand off Voltage V _{WM} (Volts)	Maximum Reverse Leakage at V _{WM} I _D (uA)	Maximum Peak Pulse Current I _{PPM} (Amps)	Maximum Clamping Voltage at I _{PPM} V _C (Volts)
	V _{BR} (Volts)						
	MIN.	MAX.					
P4FMAJ6.8	6.12	7.48	10	5.50	1000	37	10.8
P4FMAJ6.8A	6.45	7.14	10	5.80	1000	38.1	10.5
P4FMAJ7.5	6.75	8.25	10	6.05	500	34.2	11.7
P4FMAJ7.5A	7.13	7.88	10	6.40	500	35.4	11.3
P4FMAJ8.2	7.38	9.02	10	6.63	200	32	12.5
P4FMAJ8.2A	7.79	8.61	10	7.02	200	33.1	12.1
P4FMAJ9.1	8.19	10.0	1.0	7.37	50	29	13.8
P4FMAJ9.1A	8.65	9.55	1.0	7.78	50	29.9	13.4
P4FMAJ10	9.00	11.0	1.0	8.10	10	26.7	15.0
P4FMAJ10A	9.50	10.5	1.0	8.55	10	27.6	14.5
P4FMAJ11	9.90	12.1	1.0	8.92	5.0	24.7	16.2
P4FMAJ11A	10.5	11.6	1.0	9.40	5.0	25.6	15.6
P4FMAJ12	10.8	13.2	1.0	9.72	5.0	23.1	17.3
P4FMAJ12A	11.4	12.6	1.0	10.2	5.0	24	16.7
P4FMAJ13	11.7	14.3	1.0	10.5	5.0	21.1	19.0
P4FMAJ13A	12.4	13.7	1.0	11.1	5.0	22	18.2
P4FMAJ15	13.5	16.3	1.0	12.1	5.0	18.2	22.0
P4FMAJ15A	14.3	15.8	1.0	12.8	5.0	18.9	21.2
P4FMAJ16	14.4	17.6	1.0	12.9	5.0	17	23.5
P4FMAJ16A	15.2	16.8	1.0	13.6	5.0	17.8	22.5
P4FMAJ18	16.2	19.8	1.0	14.5	5.0	15.1	26.5
P4FMAJ18A	17.1	18.9	1.0	15.3	5.0	15.9	25.2
P4FMAJ20	18.0	22.0	1.0	16.2	5.0	13.7	29.1
P4FMAJ20A	19.0	21.0	1.0	17.1	5.0	14.4	27.7
P4FMAJ22	19.8	24.2	1.0	17.8	5.0	12.5	31.9
P4FMAJ22A	20.9	23.1	1.0	18.8	5.0	13.1	30.6
P4FMAJ24	21.6	26.4	1.0	19.4	5.0	11.5	34.7
P4FMAJ24A	22.8	25.2	1.0	20.5	5.0	12	33.2
P4FMAJ27	24.3	29.7	1.0	21.8	5.0	10.2	39.1
P4FMAJ27A	25.7	28.4	1.0	23.1	5.0	10.7	37.5
P4FMAJ30	27.0	33.0	1.0	24.3	5.0	9.2	43.5
P4FMAJ30A	28.5	31.5	1.0	25.6	5.0	9.7	41.4
P4FMAJ33	29.7	36.3	1.0	26.8	5.0	8.4	47.7
P4FMAJ33A	31.4	34.7	1.0	28.2	5.0	8.8	45.7
P4FMAJ36	32.4	39.6	1.0	29.1	5.0	7.7	52.0
P4FMAJ36A	34.2	37.8	1.0	30.8	5.0	8	49.9
P4FMAJ39	35.1	42.9	1.0	31.6	5.0	7.1	56.4
P4FMAJ39A	37.1	41.0	1.0	33.3	5.0	7.4	53.9
P4FMAJ43	38.7	47.3	1.0	34.8	5.0	6.5	61.9
P4FMAJ43A	40.9	45.2	1.0	36.8	5.0	6.7	59.3
P4FMAJ47	42.3	51.7	1.0	38.1	5.0	5.9	67.8
P4FMAJ47A	44.7	49.4	1.0	40.2	5.0	6.2	64.8
P4FMAJ51	45.9	56.1	1.0	41.3	5.0	5.4	73.5
P4FMAJ51A	48.5	53.6	1.0	43.6	5.0	5.7	70.1
P4FMAJ56	50.4	61.6	1.0	45.4	5.0	5.0	80.5
P4FMAJ56A	53.2	58.8	1.0	47.8	5.0	5.2	77.0

TRANSIENT VOLTAGE SUPPRESSORS

400W SERIES TVS DIODES / DO-214AC (CASE 2) 400W

TYPE	Breakdown Voltage			Reverse Stand off Voltage V_{WM} (Volts)	Maximum Reverse Leakage at V_{WM} I_D (μ A)	Maximum Peak Pulse Current I_{PPM} (Amps)	Maximum Clamping Voltage at I_{PPM} V_C (Volts)
	V_{BR} (Volts)		@ I_T (mA)				
	MIN.	MAX.					
P4FMAJ62	55.8	68.2	1.0	50.2	5.0	4.7	89.0
P4FMAJ62A	58.9	65.1	1.0	53.0	5.0	5.0	85.0
P4FMAJ68	61.2	74.8	1.0	55.1	5.0	4.2	98.0
P4FMAJ68A	64.6	71.4	1.0	58.1	5.0	4.5	92.0
P4FMAJ75	67.5	82.5	1.0	60.7	5.0	3.8	108
P4FMAJ75A	71.3	78.8	1.0	64.1	5.0	4.0	103
P4FMAJ82	73.8	90.2	1.0	66.4	5.0	3.5	118
P4FMAJ82A	77.9	86.1	1.0	70.1	5.0	3.7	113
P4FMAJ91	81.9	100	1.0	73.7	5.0	3.2	131
P4FMAJ91A	86.5	95.5	1.0	77.8	5.0	3.3	125
*P4FMAJ100	90.0	110	1.0	81.0	5.0	2.1	144
*P4FMAJ100A	95.0	105	1.0	85.5	5.0	2.2	137
*P4FMAJ110	99.0	121	1.0	89.2	5.0	1.9	158
*P4FMAJ110A	105	116	1.0	94.0	5.0	2.0	152
*P4FMAJ120	108	132	1.0	97.2	5.0	1.7	173
*P4FMAJ120A	114	126	1.0	102	5.0	1.8	165
*P4FMAJ130	117	143	1.0	105	5.0	1.6	187
*P4FMAJ130A	124	137	1.0	111	5.0	1.7	179
*P4FMAJ150	135	165	1.0	121	5.0	1.4	215
*P4FMAJ150A	143	158	1.0	128	5.0	1.4	207
*P4FMAJ160	144	176	1.0	130	5.0	1.3	230
*P4FMAJ160A	152	168	1.0	136	5.0	1.4	219
*P4FMAJ170	153	187	1.0	138	5.0	1.2	244
*P4FMAJ170A	162	179	1.0	145	5.0	1.3	234
*P4FMAJ180	162	198	1.0	146	5.0	1.2	258
*P4FMAJ180A	171	189	1.0	154	5.0	1.2	246
*P4FMAJ200	180	220	1.0	162	5.0	1.0	287
*P4FMAJ200A	190	210	1.0	171	5.0	1.1	274
*P4FMAJ220	198	242	1.0	175	5.0	0.9	344
*P4FMAJ220A	209	231	1.0	185	5.0	0.9	328
*P4FMAJ250	225	275	1.0	202	5.0	0.83	360
*P4FMAJ250A	237	263	1.0	214	5.0	0.87	344
*P4FMAJ300	270	330	1.0	243	5.0	0.70	430
*P4FMAJ300A	285	315	1.0	256	5.0	0.73	414
*P4FMAJ350	315	385	1.0	284	5.0	0.60	504
*P4FMAJ350A	332	368	1.0	300	5.0	0.62	482
*P4FMAJ400	360	440	1.0	324	5.0	0.53	574
*P4FMAJ400A	380	420	1.0	342	5.0	0.55	548

- Notes :
1. V_{BR} measured after I_T applied for 300ms. I_T = square pulse or equivalent.
 2. For bidirectional use C or CA suffixs for all types (ex. P4FMAJ6.8C,P4FMAJ400CA) electrical characteristics apply in both directions.
 3. For bidirectional types having V_{WM} of 10 volts and less, the I_D limit is doubled.
 4. Mark "*" reverse power rating are 300w .

Mounting Pad Layout

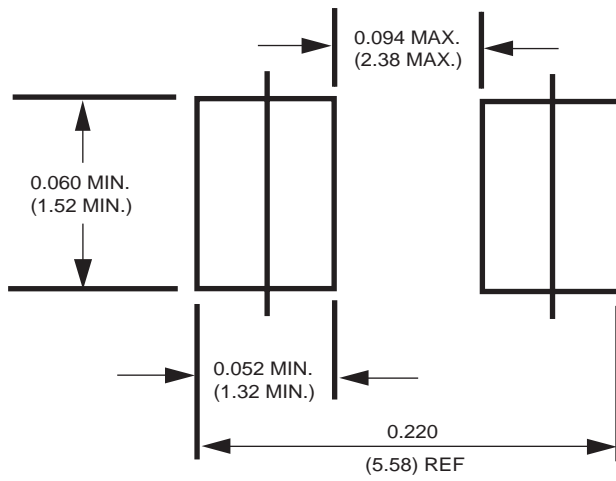

Dimensions in inches and (millimeters)

X-ON Electronics

Largest Supplier of Electrical and Electronic Components

Click to view similar products for [ESD Suppressors / TVS Diodes](#) category:

Click to view products by [Rectron](#) manufacturer:

Other Similar products are found below :

[60KS200C](#) [D12V0H1U2WS-7](#) [D18V0L1B2LP-7B](#) [82356050220](#) [D5V0M5U6V-7](#) [NTE4902](#) [P4KE27CA](#) [P6KE11CA](#) [P6KE39CA-TP](#)
[P6KE8.2A](#) [SA110CA](#) [SA60CA](#) [SA64CA](#) [SMBJ12CATR](#) [SMBJ8.0A](#) [SMLJ30CA-TP](#) [ESD101-B1-02ELS E6327](#) [ESD112-B1-02EL E6327](#)
[ESD119B1W01005E6327XTSA1](#) [ESD5V0J4-TP](#) [ESD5V0L1B02VH6327XTSA1](#) [ESD7451N2T5G](#) [19180-510](#) [CPDT-5V0USP-HF](#)
[3.0SMCJ33CA-F](#) [3.0SMCJ36A-F](#) [HSPC16701B02TP](#) [D3V3Q1B2DLP3-7](#) [D55V0M1B2WS-7](#) [DESD5V0U1BL-7B](#) [DRTR5V0U4SL-7](#)
[SCM1293A-04SO](#) [ESD200-B1-CSP0201 E6327](#) [ESD203-B1-02EL E6327](#) [SM12-7](#) [SMF8.0A-TP](#) [SMLJ45CA-TP](#) [CEN955 W/DATA](#)
[82350120560](#) [82356240030](#) [VESD12A1A-HD1-GS08](#) [CPDUR5V0R-HF](#) [CPDUR24V-HF](#) [CPDQC5V0U-HF](#) [CPDQC5V0USP-HF](#)
[CPDQC5V0-HF](#) [D1213A-01LP4-7B](#) [D1213A-02WL-7](#) [ESDLIN1524BJ-HQ](#) [5KP100A](#)