

Feed-through header - IPC 16/ 5-GU-10,16 - 1969881

Please be informed that the data shown in this PDF Document is generated from our Online Catalog. Please find the complete data in the user's documentation. Our General Terms of Use for Downloads are valid (<http://phoenixcontact.com/download>)



PCB headers, nominal current: 76 A, rated voltage (III/2): 1000 V, nominal cross section: 16 mm², number of positions: 5, pitch: 10.16 mm, color: green, contact surface: Silver, mounting: Wave soldering, pin layout: Linear pinning, solder pin [P]: 4 mm, Plug direction parallel to the PCB: connector part rotated by 180° with respect to the plug axis.

Your advantages

- ✓ Well-known mounting principle allows worldwide use
- ✓ Maximum flexibility when it comes to device design – one header for connectors with different connection technologies
- ✓ Inverted header with socket contacts for touch-proof device outputs or PCB/PCB connections
- ✓ Integrated double steel spring provides additional safety in the event of temperature and power fluctuations

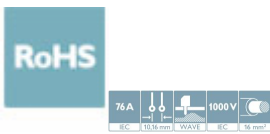

Key Commercial Data

Packing unit	50 pc
GTIN	 4 017918 948634
GTIN	4017918948634

Technical data

Item properties

Brief article description	Feed-through header
Plug-in system	POWER COMBICON 16
Type of contact	Female connector
Range of articles	IPC 16/..-GU
Pitch	10.16 mm
Number of positions	5
Mounting type	Wave soldering
Pin layout	Linear pinning
Locking	without
Number of levels	1
Number of connections	5
Number of potentials	5

Feed-through header - IPC 16/ 5-GU-10,16 - 1969881

Technical data

Electrical parameters

Nominal current	76 A
Nom. voltage	1000 V
Rated voltage	1000 V
Rated voltage (III/2)	1000 V
Rated voltage (II/2)	1000 V
Rated surge voltage (III/3)	8 kV
Rated surge voltage (III/2)	8 kV
Rated surge voltage (II/2)	8 kV

Material data - contact

Note	WEEE/RoHS-compliant, free of whiskers according to IEC 60068-2-82/ JEDEC JESD 201
Contact material	Cu alloy
Metal surface contact area (top layer)	Silver (4 - 8 µm Ag)
Metal surface soldering area (top layer)	Silver (4 - 8 µm Ag)

Material data - housing

Housing color	green (6021)
Insulating material	PA
Insulating material group	I
CTI according to IEC 60112	600
Flammability rating according to UL 94	V0
Glow wire flammability index GWFI according to EN 60695-2-12	850
Glow wire ignition temperature GWIT according to EN 60695-2-13	775
Temperature for the ball pressure test according to EN 60695-10-2	125 °C

Dimensions for the product

Length [l]	32.1 mm
Width [w]	51.6 mm
Height [h]	17.4 mm
Pitch	10.16 mm
Height (without solder pin)	13.6 mm
Solder pin [P]	4 mm
Pin spacing	10.16 mm
Pin dimensions	0.8 x 1.2 mm

Dimensions for PCB design

Hole diameter	1.7 mm
Pin spacing	10.16 mm

Packaging information

Type of packaging	packed in cardboard
Pieces per package	50
Denomination packing units	Pcs.

Feed-through header - IPC 16/ 5-GU-10,16 - 1969881

Technical data

Standards and Regulations

Connection in acc. with standard	CUL
Flammability rating according to UL 94	V0

Environmental Product Compliance

China RoHS	Environmentally friendly use period: unlimited = EFUP-e
	No hazardous substances above threshold values

Drawings

Drilling diagram

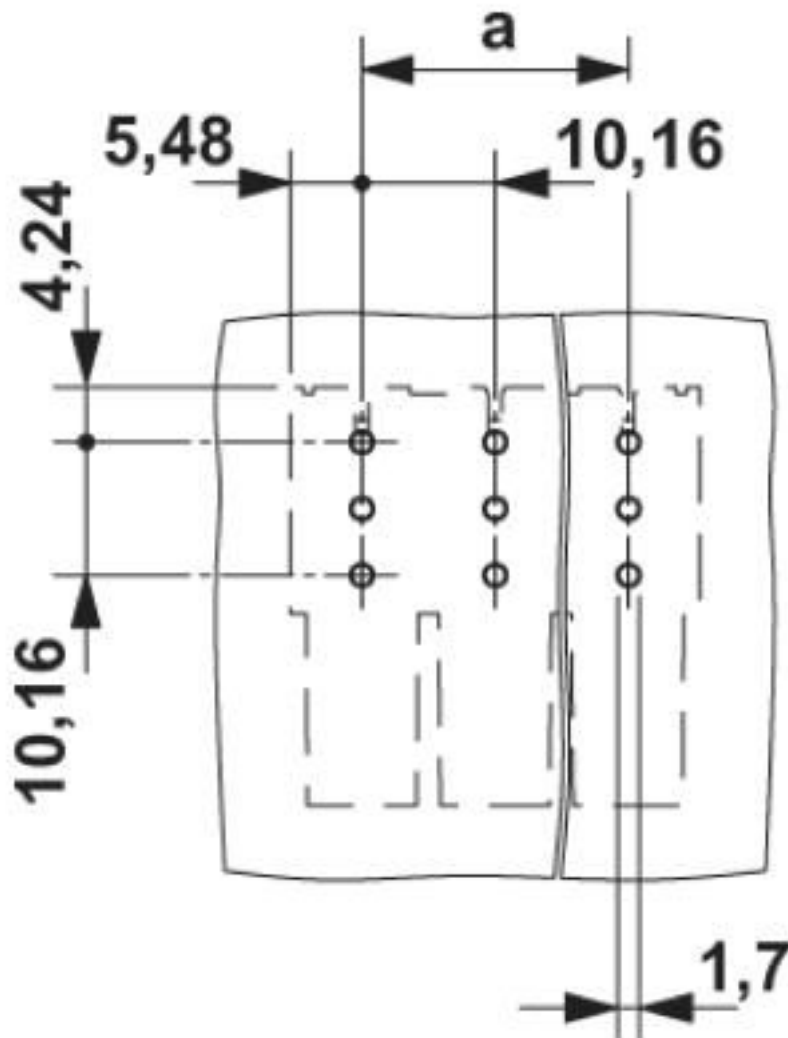

The figure shows the 3-pos. version

Feed-through header - IPC 16/ 5-GU-10,16 - 1969881

Dimensional drawing

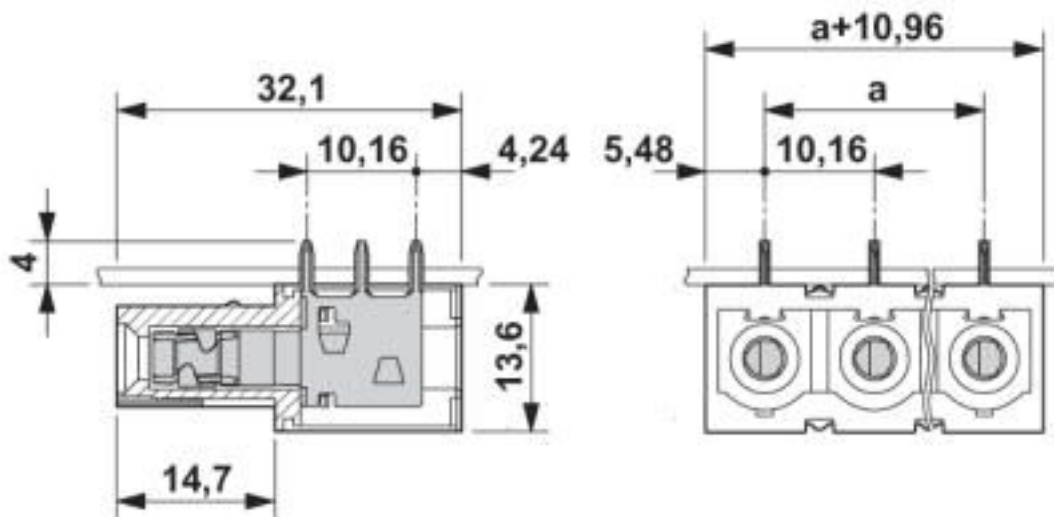

The figure shows the 3-pos. version

Classifications

eCl@ss

eCl@ss 10.0.1	27440402
eCl@ss 4.0	27260700
eCl@ss 4.1	27260700
eCl@ss 5.0	27260700
eCl@ss 5.1	27260700
eCl@ss 6.0	27260700
eCl@ss 7.0	27440402
eCl@ss 8.0	27440402
eCl@ss 9.0	27440402

ETIM

ETIM 3.0	EC001121
ETIM 4.0	EC002637
ETIM 5.0	EC002637
ETIM 6.0	EC002637
ETIM 7.0	EC002637

UNSPSC

UNSPSC 6.01	30211810
UNSPSC 7.0901	39121409
UNSPSC 11	39121409
UNSPSC 12.01	39121409
UNSPSC 13.2	39121409

Feed-through header - IPC 16/ 5-GU-10,16 - 1969881

Classifications

UNSPSC

UNSPSC 18.0	39121409
UNSPSC 19.0	39121409
UNSPSC 20.0	39121409
UNSPSC 21.0	39121409

Approvals

Approvals

Approvals

IECEE CB Scheme / SEV / EAC / cULus Recognized

Ex Approvals

Approval details

IECEE CB Scheme		http://www.iecee.org/	CH-10653-M1
Nominal voltage UN	1000 V		
Nominal current IN	76 A		

SEV		https://www.eurofins.ch/de/	IK-4468-M1
Nominal voltage UN	1000 V		
Nominal current IN	76 A		

EAC		B.01687	
-----	---	---------	--

cULus Recognized		http://database.ul.com/cgi-bin/XYV/template/LISEXT/1FRAME/index.htm		E60425-20040202
	B	C	D	
Nominal voltage UN	300 V	300 V	600 V	
Nominal current IN	66 A	66 A	5 A	

Feed-through header - IPC 16/ 5-GU-10,16 - 1969881

Accessories

Accessories

Coding element

Coding profile - CP-PC RD - 1701967

Coding profile, for plugging into the coding ribs of the plug at a later date, insulating material, color: Red



Coding element - CS-IPC 16/ 6 - 1970016

Coding pin, serves to ensure correct polarization on the PCB during manual mounting



Terminal marking

Marker card - SK U/5,0 WH:UNBEDRUCKT - 0803922

Marker card, Sheet, white, unlabeled, can be labeled with: PLOTMARK, CMS-P1-PLOTTER, Office printing systems, mounting type: adhesive, for terminal block width: 210 mm, lettering field size: 186 x 5 mm, Number of individual labels: 630



Additional products

Printed-circuit board connector - IPC 16/ 5-ST-10,16 - 1969409



PCB connector, nominal current: 76 A, rated voltage (III/2): 1000 V, nominal cross section: 16 mm², number of positions: 5, pitch: 10.16 mm, connection method: Screw connection with tension sleeve, color: green, contact surface: Silver

Printed-circuit board connector - ISPC 16/ 5-ST-10,16 - 1748574



PCB connector, nominal current: 76 A, rated voltage (III/2): 1000 V, nominal cross section: 16 mm², number of positions: 5, pitch: 10.16 mm, connection method: Push-in spring connection, color: green, contact surface: Silver

Feed-through header - IPC 16/ 5-GU-10,16 - 1969881

Accessories

Feed-through header - PC 6-16/ 5-G1-10,16 - 1998962



PCB headers, nominal current: 76 A, rated voltage (III/2): 1000 V, nominal cross section: 16 mm², number of positions: 5, pitch: 10.16 mm, color: green, contact surface: Silver, mounting: Wave soldering, pin layout: Linear pinning, solder pin [P]: 4 mm

Feed-through header - PC 6-16/ 5-G1U-10,16 - 1996265



PCB headers, nominal current: 76 A, rated voltage (III/2): 1000 V, nominal cross section: 16 mm², number of positions: 5, pitch: 10.16 mm, color: green, contact surface: Silver, mounting: Wave soldering, pin layout: Linear pinning, solder pin [P]: 4 mm

Feed-through header - PCV 6-16/ 5-G1-10,16 - 1998810



PCB headers, nominal current: 76 A, rated voltage (III/2): 1000 V, nominal cross section: 16 mm², number of positions: 5, pitch: 10.16 mm, color: green, contact surface: Silver, mounting: Wave soldering, pin layout: Linear pinning, solder pin [P]: 4 mm

Phoenix Contact 2020 © - all rights reserved
<http://www.phoenixcontact.com>

PHOENIX CONTACT GmbH & Co. KG
Flachsmarktstr. 8
32825 Blomberg
Germany
Tel. +49 5235 300
Fax +49 5235 3 41200
<http://www.phoenixcontact.com>

X-ON Electronics

Largest Supplier of Electrical and Electronic Components

Click to view similar products for [Pluggable Terminal Blocks](#) category:

Click to view products by [Phoenix Contact](#) manufacturer:

Other Similar products are found below :

[57.510.0053](#) [MC 1.5/ 6-ST-3.5 GY AU](#) [734-104](#) [734-302](#) [8-141-P](#) [8426620000](#) [860505](#) [860516](#) [860810](#) [GBPACX-12](#) [93.731.4953.0](#) [PV05-5,08-K](#) [PVP02-5,00](#) [PVP03-3,50](#) [PVP04-3,50](#) [PVS02-5,00](#) [1-1986160-3](#) [1377680000](#) [1531000000](#) [1546228-5](#) [ELFH16150](#) [ELFP03110](#) [ELFP10210](#) [ELFT06250](#) [ELVP03100](#) [1700101](#) [1700410](#) [1700425](#) [1702246](#) [1705229](#) [1710175](#) [1714537](#) [1717806](#) [1719600](#) [1728941](#) [1734692](#) [1734795](#) [1736036](#) [1740194](#) [1740291](#) [1740628](#) [1740990](#) [1746952](#) [1750207](#) [1752441](#) [1752865](#) [1754115](#) [1754144](#) [1756913](#) [1760051](#)