

High speed 650V Field Stop Trench IGBT co-packed with fast and soft recovery anti-parallel diode

V_{CE}	650 V	I_c	40 A
V_{CEsat}	1.65 V	E_{OFF}	0.39 mJ

Features

- Superior high speed switching IGBT
- Low saturation voltage 1.65V at T_{VJ} 25 °C
- Co-packed with low Q_{rr} and soft recovery diode
- Maximum junction temperature T_{VJ} 175 °C
- Easy paralleling usage due to positive coefficient V_{CEsat}
- Lead free in compliance with EU RoHS 2.0
- Green molding compound as per IEC 61249 standard

Mechanical Data

- Case: TO-247-3L molded plastic
- Terminals: Solderable per MIL-STD-750, Method 2026
- Approx. Weight: 6.157grams

Application

- UPS
- PV Inverter
- EV Charger
- Welding machine
- Home appliance

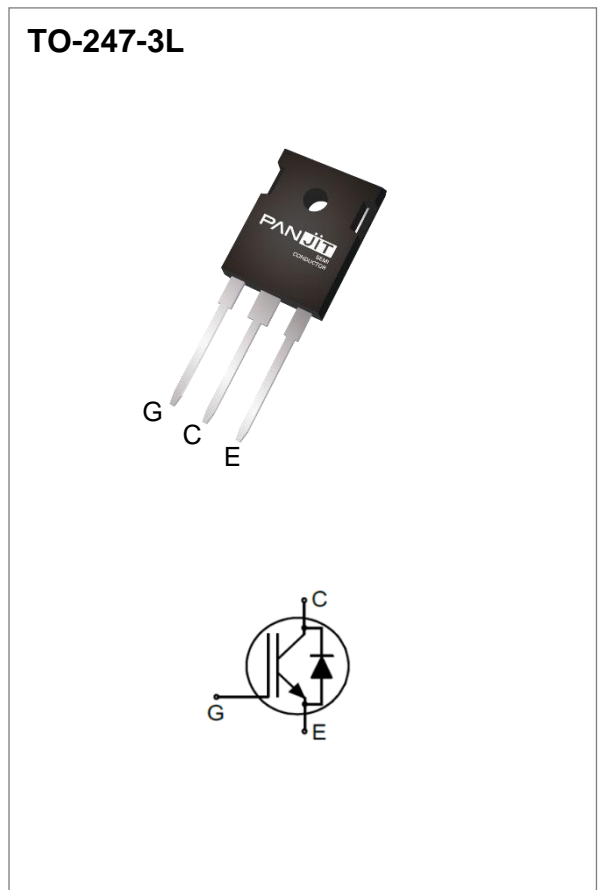

Maximum Ratings

PARAMETER	SYMBOL	LIMIT	UNITS
Collector-Emitter Voltage	V _{CE}	650	V
Gate-Emitter Voltage	V _{GE}	± 20	V
DC Collector Current @ T _C = 25°C	I _c	76	A
DC Collector Current @ T _C = 100°C	I _c	46	A
Pulsed Collector Current, t _P limited by T _{VJmax}	I _{Cpulse}	120	A
Turn-off safe operating area V _{CC} ≤ 400 V, V _{CE,peak} < 650 V, V _{GE} = 0/15 V, R _{Goff} ≥ 10 Ω, T _{VJ} ≤ 175 °C	-	120	A
Diode Forward Current @ T _C = 25°C	I _F	40	A
Diode Forward Current @ T _C = 100°C	I _F	20	A

PARAMETER	SYMBOL	LIMIT	UNITS
Pulsed Diode Current, t_p limited by T_{VJmax}	I_{Fpulse}	120	A
Power Dissipation @ $T_C = 25^\circ C$	P_{total}	220	W
Power Dissipation @ $T_C = 100^\circ C$		110	
Operating Junction Temperature Range	T_{VJ}	-40 to +175	$^\circ C$
Storage Temperature Range	T_{STG}	-55 to +150	$^\circ C$
Soldering Temperature, 1/8" from case for 5 seconds	T_{SLD}	260	$^\circ C$

Typical Ratings

PARAMETER	SYMBOL	TYP.	UNITS
Non-Repetitive Forward Surge Current (Half-Sine Pulse, $t_p = 8.3$ ms, $T_C = 25^\circ C$)	I_{FM}	350	A
(Half-Sine Pulse, $t_p = 8.3$ ms, $T_C = 150^\circ C$)		295	
Internal emitter inductance measured 5mm(0.197 in.) from case	L_E	13	nH

Thermal Resistance

PARAMETER	SYMBOL	CONDITION	MIN.	TYP.	MAX.	UNITS
Thermal Resistance Junction to Case, for IGBT	$R_{\theta JC}$	-	-	-	0.68	$^\circ C/W$
Thermal Resistance Junction to Case, for Diode	$R_{\theta JC}$	-	-	-	0.68	$^\circ C/W$
Thermal Resistance Junction to Ambient	$R_{\theta JA}$	-	-	-	40	$^\circ C/W$

Electrical Characteristics ($T_{VJ} = 25\text{ }^{\circ}\text{C}$ unless otherwise specified)

PARAMETER	SYMBOL	TEST CONDITION	MIN.	TYP.	MAX.	UNITS
-----------	--------	----------------	------	------	------	-------

Static Characteristic

Collector-Emitter Breakdown Voltage	$V_{(BR)CES}$	$V_{GE} = 0V, I_C = 0.5mA$	650	-	-	V
Collector-Emitter Saturation Voltage	V_{CEsat}	$V_{GE} = 15V, I_C = 40A$ $T_{VJ} = 25\text{ }^{\circ}\text{C}$ $T_{VJ} = 125\text{ }^{\circ}\text{C}$ $T_{VJ} = 175\text{ }^{\circ}\text{C}$	-	1.65	2.25	
Gate-Emitter Threshold Voltage	$V_{GE(th)}$	$I_C = 40mA, V_{CE} = V_{GE}$	3.0	4.5	6.0	V
Collector-Emitter Cut Off Current	I_{CES}	$V_{GE} = 0V, V_{CE} = 650V$	-	-	80	μA
Gate-Emitter Leakage Current	I_{GES}	$V_{GE} = 20V, V_{CE} = 0V$	-	-	200	nA
Transconductance	g_{fs}	$V_{CE} = 20V, I_C = 40A$	-	29	-	S

Dynamic Characteristic

Input Capacitance	C_{ies}	$V_{CE} = 25V, V_{GE} = 0V$ $f = 1MHz$	-	1840	-	pF
Output Capacitance	C_{oes}		-	95	-	
Reverse Transfer Capacitance	C_{res}		-	13	-	
Gate Charge	Q_G	$V_{CE} = 520V, I_C = 40A$ $V_{GE} = 15V$	-	65	-	nC

Switching Characteristic, Inductive Load

Turn-On Delay Time	$t_{d(on)}$	$T_{VJ} = 25\text{ }^{\circ}\text{C}$ $V_{CC} = 400V, I_C = 20A$ $V_{GE} = 0 / 15V$ $R_G = 10\Omega$	-	14	-	ns
Rise Time	t_r		-	14	-	ns
Turn-Off Delay Time	$t_{d(off)}$		-	96	-	ns
Fall Time	t_f		-	16	-	ns
Turn-On Energy	E_{on}		-	0.33	-	mJ
Turn-Off Energy	E_{off}		-	0.12	-	mJ
Total Switching Energy	E_{ts}		-	0.45	-	mJ
Turn-On Delay Time	$t_{d(on)}$	$T_{VJ} = 25\text{ }^{\circ}\text{C}$ $V_{CC} = 400V, I_C = 40A$ $V_{GE} = 0 / 15V$ $R_G = 10\Omega$	-	15	-	ns
Rise Time	t_r		-	31	-	ns
Turn-Off Delay Time	$t_{d(off)}$		-	86	-	ns
Fall Time	t_f		-	38	-	ns
Turn-On Energy	E_{on}		-	0.75	-	mJ
Turn-Off Energy	E_{off}		-	0.39	-	mJ
Total Switching Energy	E_{ts}		-	1.14	-	mJ

Turn-On Delay Time	$t_{d(on)}$	$T_{VJ} = 175^{\circ}\text{C}$ $V_{CC} = 400\text{V}, I_C = 20\text{A}$ $V_{GE} = 0 / 15\text{V}$ $R_G = 10\Omega$	-	13	-	ns
Rise Time	t_r		-	14	-	ns
Turn-Off Delay Time	$t_{d(off)}$		-	123	-	ns
Fall Time	t_f		-	17	-	ns
Turn-On Energy	E_{on}		-	0.59	-	mJ
Turn-Off Energy	E_{off}		-	0.22	-	mJ
Total Switching Energy	E_{ts}		-	0.81	-	mJ
Turn-On Delay Time	$t_{d(on)}$	$T_{VJ} = 175^{\circ}\text{C}$ $V_{CC} = 400\text{V}, I_C = 40\text{A}$ $V_{GE} = 0 / 15\text{V}$ $R_G = 10\Omega$	-	15	-	ns
Rise Time	t_r		-	31	-	ns
Turn-Off Delay Time	$t_{d(off)}$		-	103	-	ns
Fall Time	t_f		-	33	-	ns
Turn-On Energy	E_{on}		-	1.21	-	mJ
Turn-Off Energy	E_{off}		-	0.49	-	mJ
Total Switching Energy	E_{ts}		-	1.70	-	mJ

Diode Characteristic

Diode Forward Voltage	V_F	$V_{GE} = 0\text{V}, I_F = 20\text{A}$ $T_{VJ} = 25^{\circ}\text{C}$ $T_{VJ} = 125^{\circ}\text{C}$ $T_{VJ} = 175^{\circ}\text{C}$	-	1.60	-	V
Reverse Recovery Time	t_{rr}	$I_F = 20\text{A}, V_R = 400\text{V},$ $di/dt = 1000\text{A}/\mu\text{s},$ $T_{VJ} = 25^{\circ}\text{C}$	-	64	-	ns
Reverse Recovery Charge	Q_{rr}		-	400	-	nC
Reverse Recovery Current	I_{rrm}		-	13	-	A
Reverse Recovery Energy	E_{rec}		-	56	-	μJ
Diode peak rate of fall of reverse recovery current	dI_{rr}/dt		-	597	-	$\text{A}/\mu\text{s}$
Reverse Recovery Time	t_{rr}	$I_F = 20\text{A}, V_R = 400\text{V},$ $di/dt = 1000\text{A}/\mu\text{s},$ $T_{VJ} = 175^{\circ}\text{C}$	-	80	-	ns
Reverse Recovery Charge	Q_{rr}		-	746	-	nC
Reverse Recovery Current	I_{rrm}		-	18	-	A
Reverse Recovery Energy	E_{rec}		-	122	-	μJ
Diode peak rate of fall of reverse recovery current	dI_{rr}/dt		-	465	-	$\text{A}/\mu\text{s}$

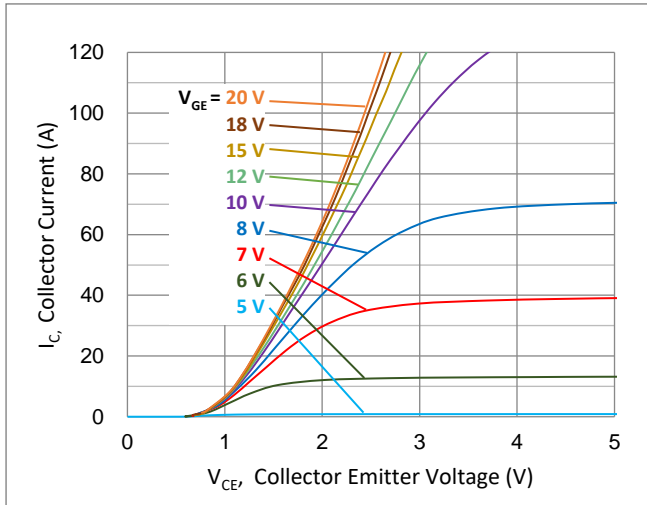

Fig.1 Typical Output Characteristic ($T_{vj} = 25^\circ\text{C}$)

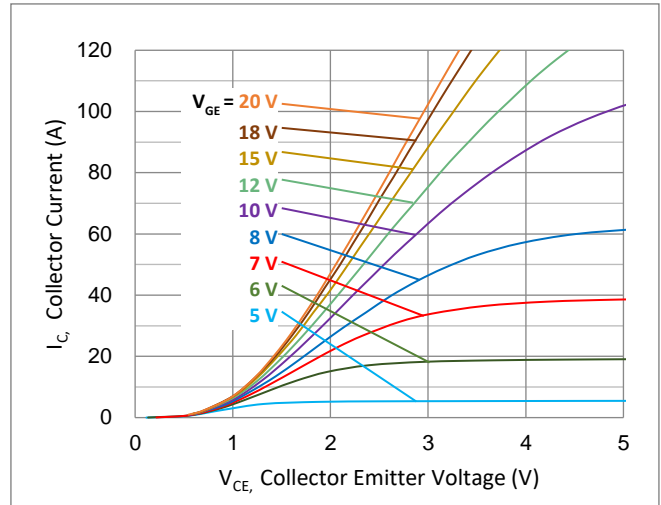

Fig.2 Typical Output Characteristic ($T_{vj} = 175^\circ\text{C}$)

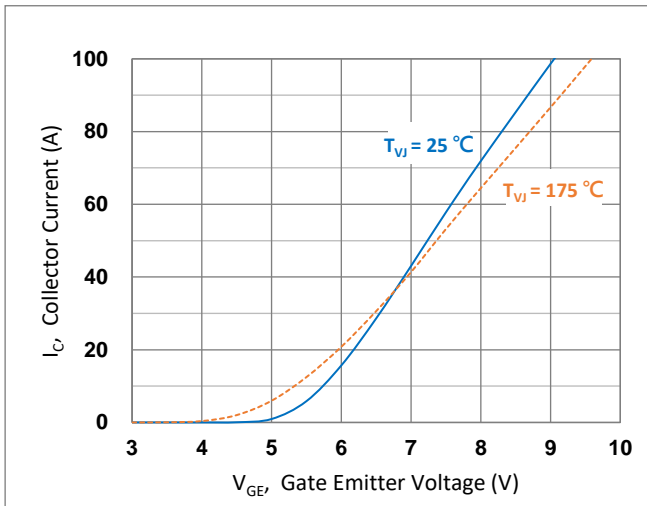

Fig.3 Typical Transfer Characteristic ($V_{CE} = 20\text{V}$)

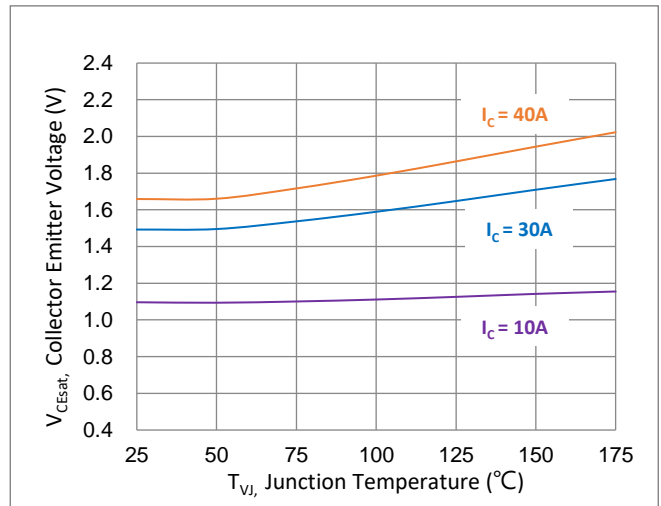

Fig.4 V_{CEsat} vs. T_{vj}

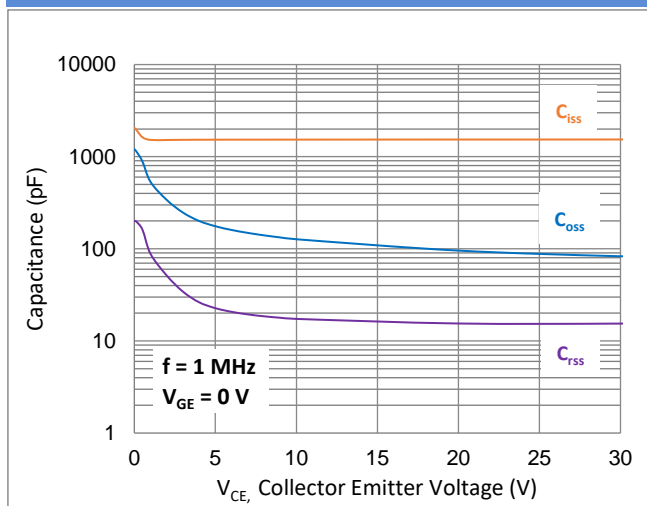

Fig.5 Typical Capacitance

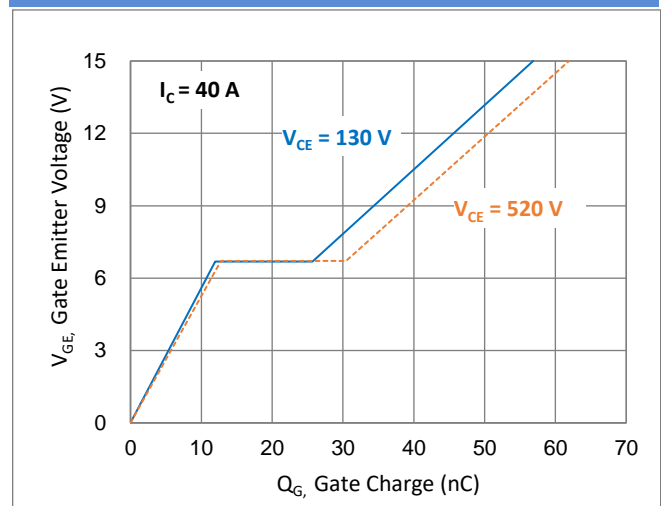

Fig.6 Typical Gate Charge

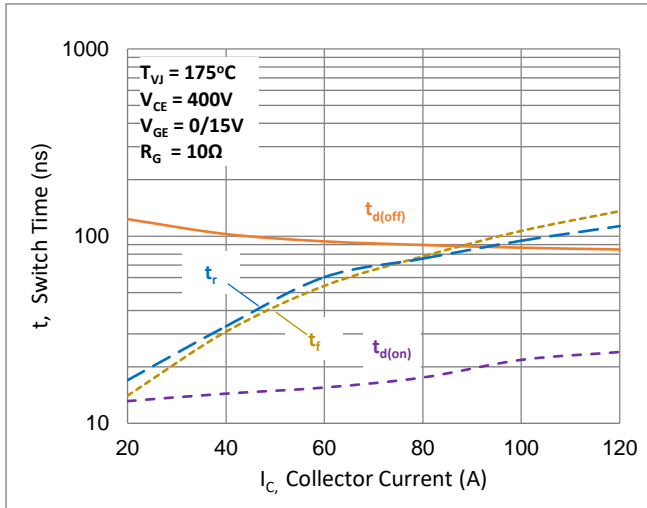

Fig.7 Typical Switching Time vs. I_c

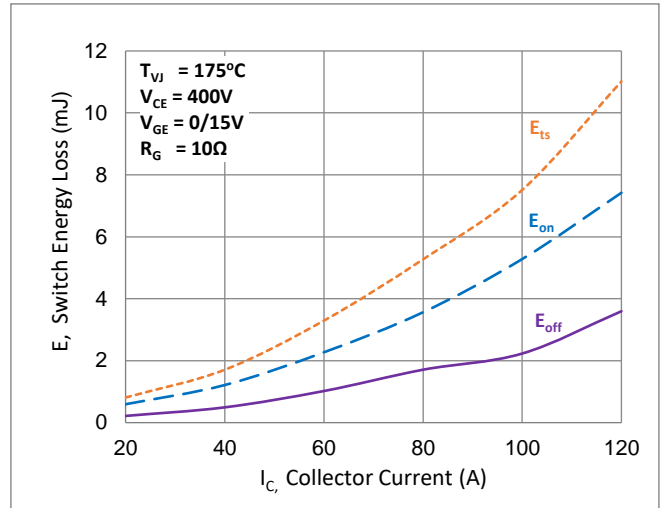

Fig.8 Typical Switching Energy Loss vs. I_c

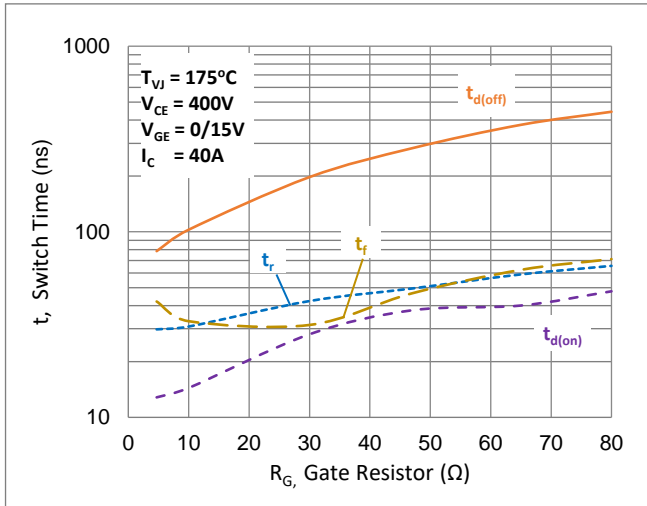

Fig.9 Typical Switching Time vs. R_g

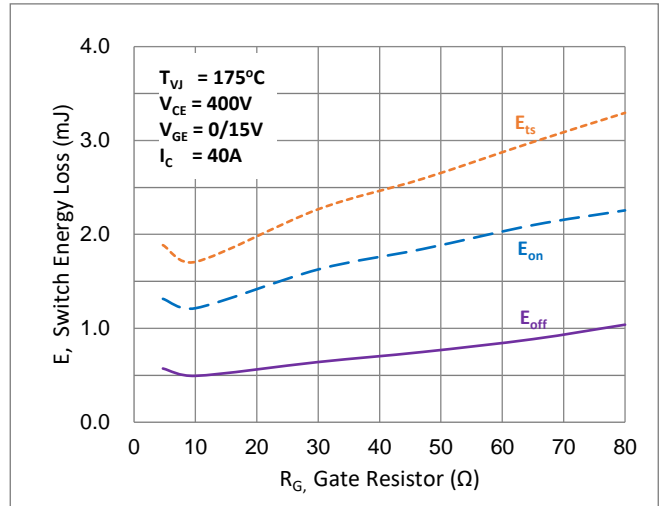

Fig.10 Typical Switching Energy Loss vs. R_g

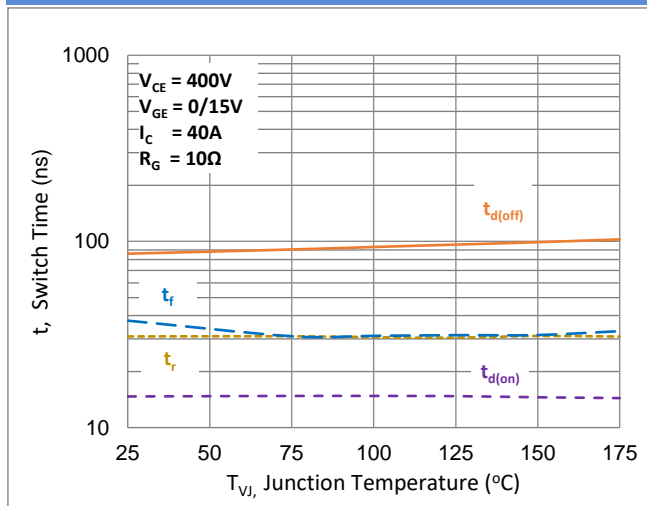

Fig.11 Typical Switching Time vs. T_{vj}

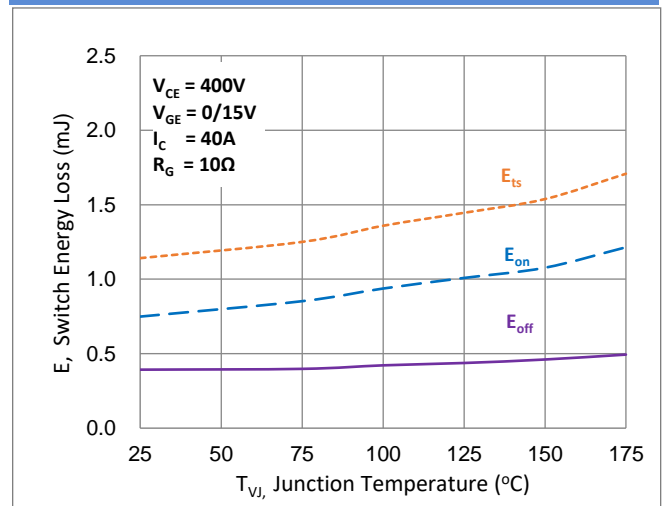

Fig.12 Typical Switching Energy Loss vs. T_{vj}

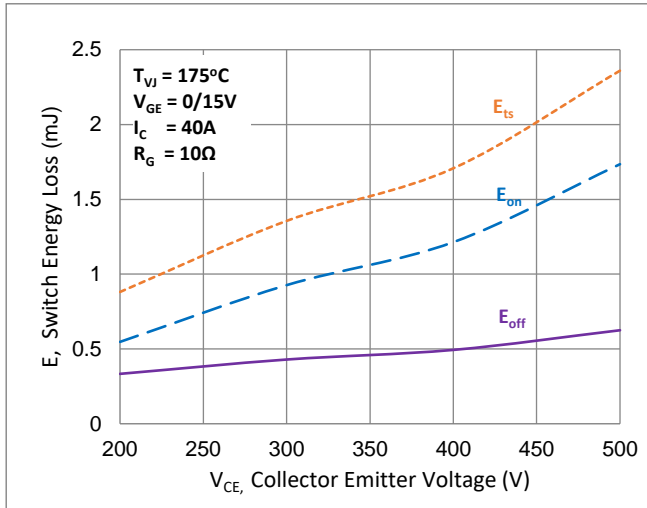

Fig.13 Typical Switching Energy Loss vs. V_{CE}

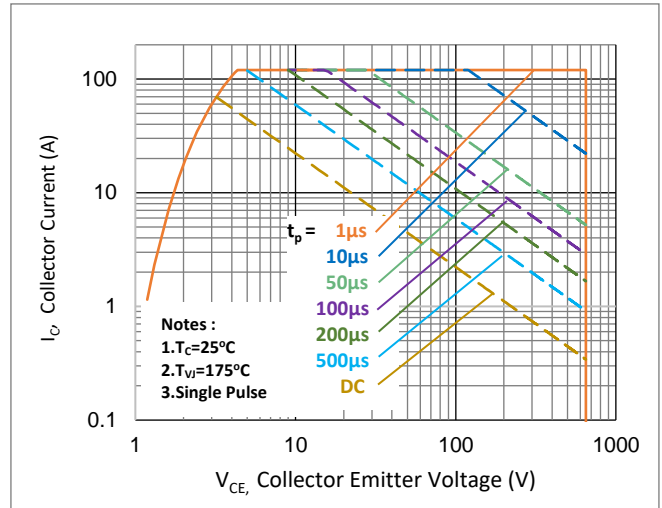

Fig.14 SOA Characteristic

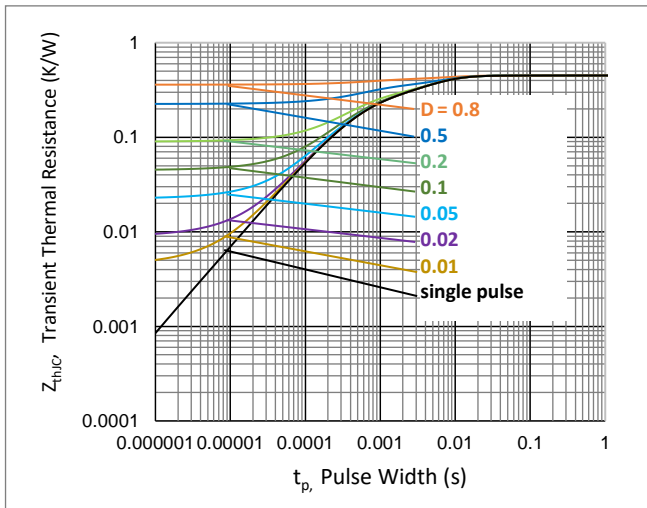

Fig.15 IGBT Thermal Impedance

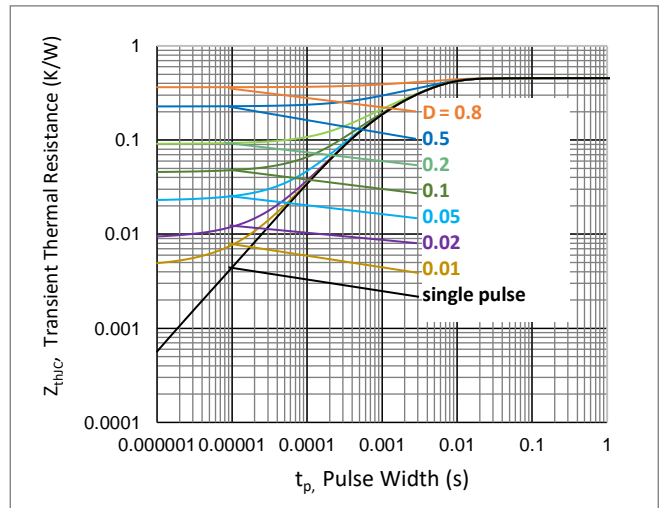

Fig.16 Diode Thermal Impedance

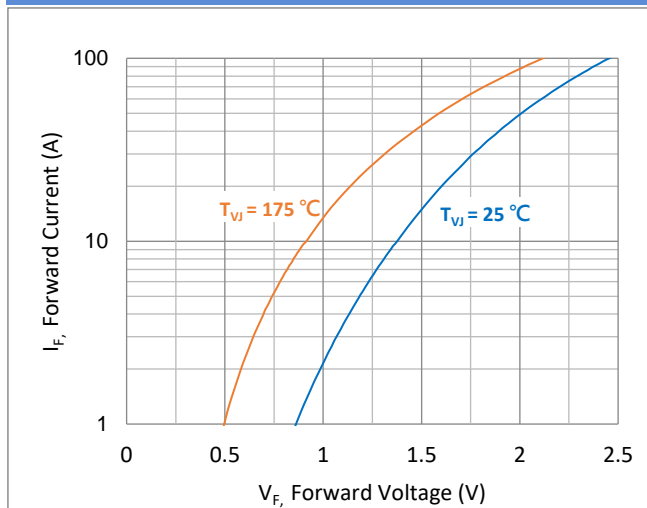

Fig.17 Typical Diode Forward Characteristic

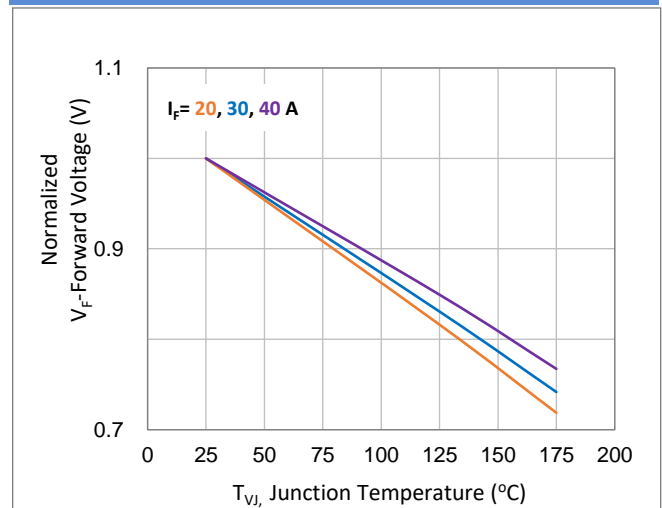

Fig.18 Diode Forward Voltage vs. T_{vj}

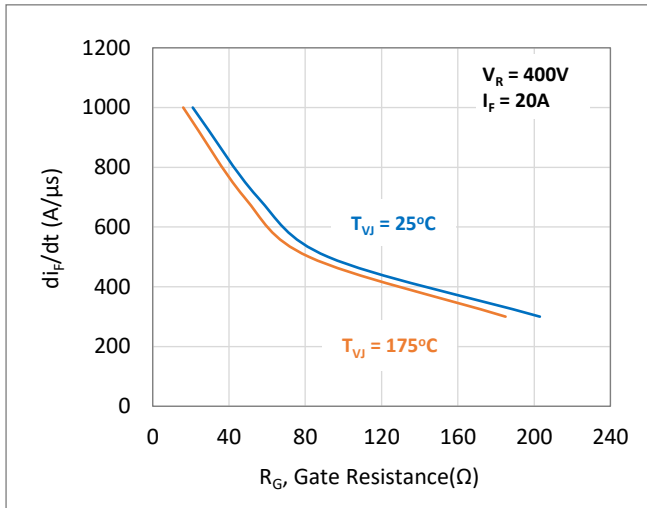

Fig.19 Typical Diode Current Slope vs. R_G

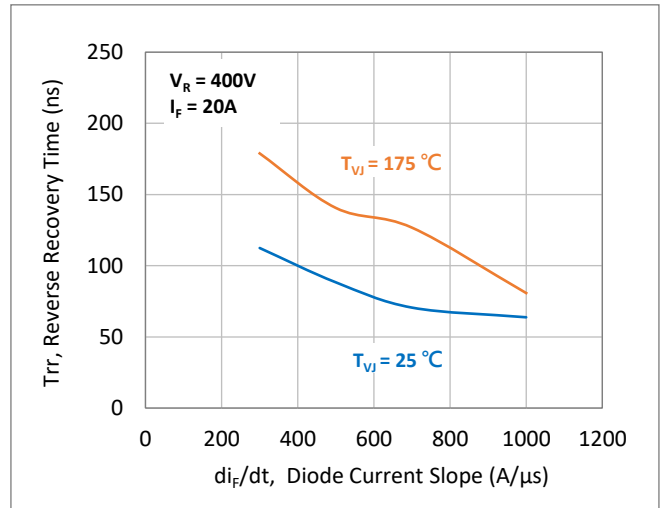

Fig.20 Typical Reverse Recovery Time vs di_F/dt

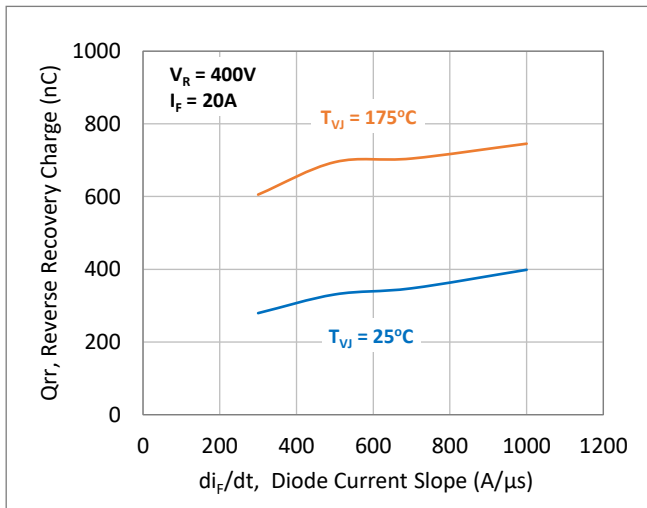

Fig.21 Typical Reverse Recovery Charge vs di_F/dt

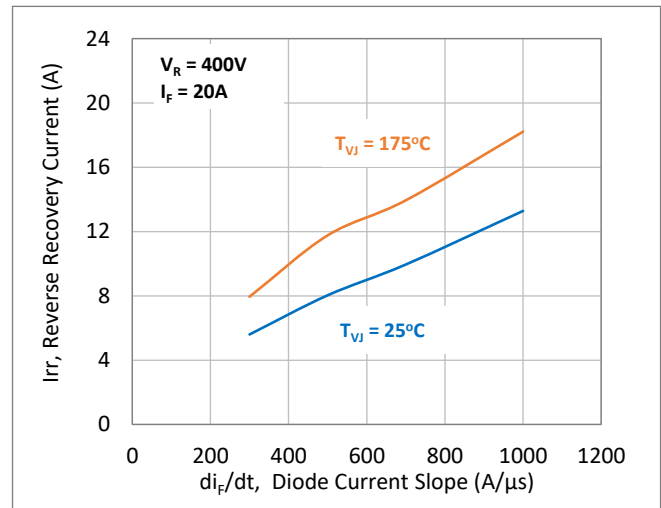

Fig.22 Typical Reverse Recovery Current vs di_F/dt

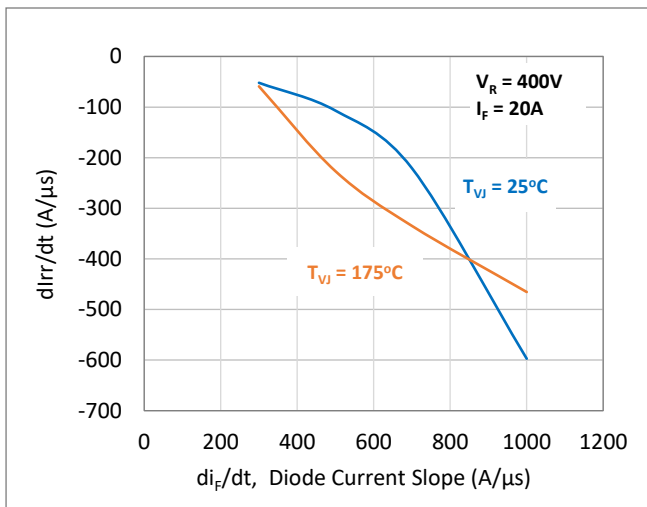

Fig.23 $dlrr/dt$ vs. di_F/dt

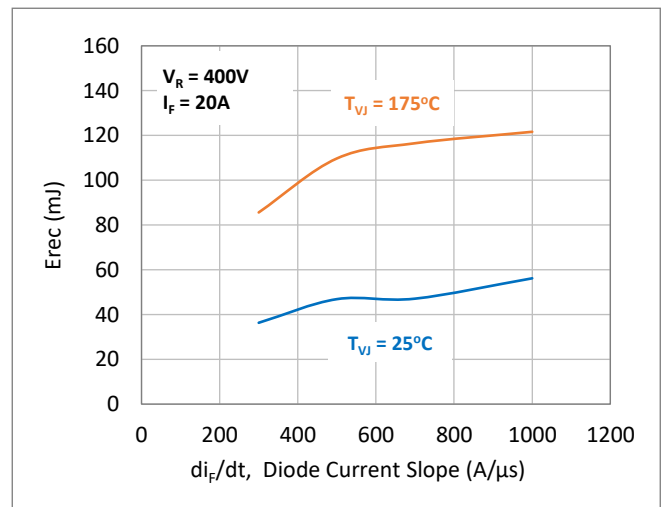
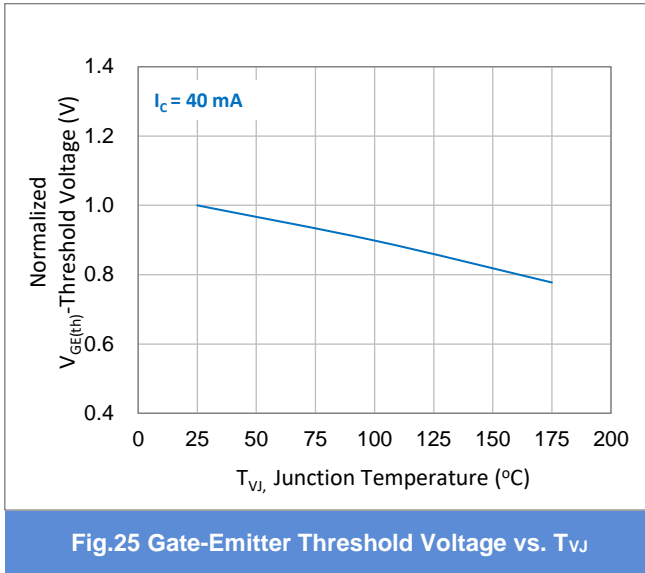

Fig.24 Typical reverse energy losses vs. di_F/dt



Product and Packing Information

Part No.	Package Type	Packing Type	Marking
PTGH4065S1	TO-247-3L	30pcs / Tube	TGH4065S1

Packaging Information

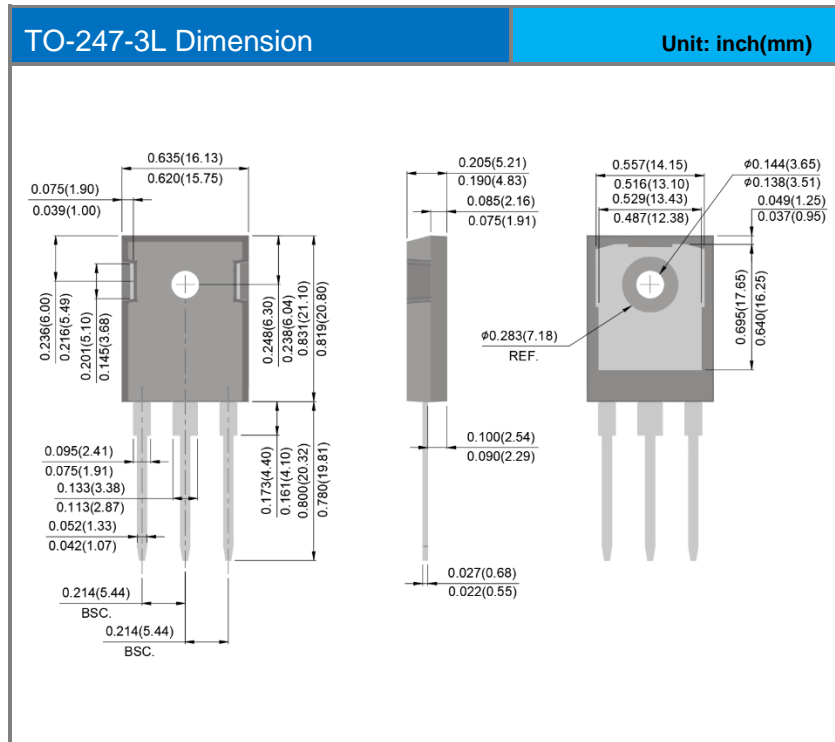

Disclaimer

- Reproducing and modifying information of the document is prohibited without permission from Panjit International Inc..
- Panjit International Inc. reserves the rights to make changes of the content herein the document anytime without notification. Please refer to our website for the latest document.
- Panjit International Inc. disclaims any and all liability arising out of the application or use of any product including damages incidentally and consequentially occurred.
- Panjit International Inc. does not assume any and all implied warranties, including warranties of fitness for particular purpose, non-infringement and merchantability.
- Applications shown on the herein document are examples of standard use and operation. Customers are responsible in comprehending the suitable use in particular applications. Panjit International Inc. makes no representation or warranty that such applications will be suitable for the specified use without further testing or modification.
- The products shown herein are not designed and authorized for equipments requiring high level of reliability or relating to human life and for any applications concerning life-saving or life-sustaining, such as medical instruments, transportation equipment, aerospace machinery et cetera. Customers using or selling these products for use in such applications do so at their own risk and agree to fully indemnify Panjit International Inc. for any damages resulting from such improper use or sale.
- Since Panjit uses lot number as the tracking base, please provide the lot number for tracking when complaining.

X-ON Electronics

Largest Supplier of Electrical and Electronic Components

Click to view similar products for [Panjit manufacturer](#):

Other Similar products are found below :

[1.5KE150A_AY_10001](#) [1.5KE200A_AY_10001](#) [1.5KE33A_AY_10001](#) [1.5KE75A_AY_10001](#) [1.5SMC27CA-AU_R1_000A1](#)
[1.5SMC36CA_R1_00001](#) [1.5SMC39CA_R1_00001](#) [1.5SMC82CA_R1_00001](#) [1.5SMCJ13A_R1_00001](#) [1.5SMCJ150CA_R1_00001](#)
[1.5SMCJ15AS_R1_00001](#) [1.5SMCJ20CA_R1_00001](#) [1.5SMCJ24CA_R1_00001](#) [1.5SMCJ28CA_R1_00001](#) [1.5SMCJ30CA_R1_00001](#)
[1.5SMCJ33A_R1_00001](#) [1.5SMCJ33A-AU_R1_000A1](#) [1.5SMCJ33CA_R1_00001](#) [1.5SMCJ36A_R1_00001](#) [1.5SMCJ36A_R1_10001](#)
[1.5SMCJ36CA_R1_00001](#) [1.5SMCJ40A_R1_00001](#) [1.5SMCJ48A_R1_00001](#) [1.5SMCJ51CAS](#) [1N4007G_AY_00001](#) [1N4007G_AY_00101](#)
[1N4007G_AY_10001](#) [1N4148-35_AX_10001](#) [1N4148-35_AY_10001](#) [1N4148W_R1_00001](#) [1N4148W_R1_00101](#) [1N4148W_R2_00001](#)
[1N4148W-AU_R1_000A1](#) [1N4148W-AU_R2_000A1](#) [1N4148WS_R1_00001](#) [1N4148WS_R1_00101](#) [1N4148WS-AU_R1_00001](#)
[1N4148WS-AU_R1_000A1](#) [1N4148WS-R1_000A4](#) [1N4448W_R1_00001](#) [1N4448WS_R1_00001](#) [1N4734A-G_AY_10001](#)
[1N4737A_AY_10001](#) [1N4737A-G_AY_10001](#) [1N4742A-G_AY_10001](#) [1N4743A-G](#) [1N4744A_AY_10001](#) [1N4744A-G_AY_10001](#)
[1N4745A-G_AY_10001](#) [1N4745A-G-PEC](#)