

0.39 Inch Single Digit Display
OSL10391-IX (Common Anode type)
OSL10391-LX (Common Cathode type)

■ Features

- 0.39 Inch Single Digit Display
- Long lifetime operation
- IC compatible
- Low power dissipation
- Black surface & white segment or dot
- Number of Pins:10

■ Applications







- Counting device
- Clock

■ Absolute Maximum Rating (Ta=25°C)

Item	Symbol	Value		Unit
		RA/R/YG/Y	W/B/G	
DC Forward Current	I _F	20	20	mA
Pulse Forward Current#	I _{FP}	100	100	mA
Reverse Voltage	V _R	5	5	V
Power Dissipation	P _T	44	66	mW
Operating Temperature	Topr	-30 ~ +70		°C
Storage Temperature	Tstg	-40~ +85		°C
Lead Soldering Temperature(1.6mm from seating plane)	Tsol	260°C/5sec		°C

#Pulse width Max.10ms Duty ratio max 1/10

■ Electrical -Optical Characteristics (Ta=25°C)

Part Number	Color		V _F (V)			I _R (μA)	I _v (mcd)			λD(nm)			
			Min.	Typ.	Max.	Max.	Min.	Typ.	Max.	Min.	Typ.	Max.	
			I _F =20mA			V _R =5V	I _F =20mA						
OSL10391-IW(LW)	White	W	-	3.3	3.6	20	-	65	-	X:0.27 Y:0.28			
OSL10391-IB(LB)	Blue	B		-	3.3	3.6	20	-	50	-	460	470	475
OSL10391-IG(LG)	Pure Green	G		-	3.3	3.6	20	-	200	-	515	525	530
OSL10391-IYG(LYG)	Yellow Green	YG		-	2.2	2.6	20	-	12	-	565	571	575
OSL10391-IY(LY)	Yellow	Y		-	2.1	2.5	20	-	40	-	585	590	595
OSL10391-IO(LO)	Orange	O		-	2.1	2.5	20	-	30	-	600	605	610
OSL10391-IR(LR)	Red	R		-	2.1	2.5	20	-	20	-	625	635	650
OSL10391-IRA(LRA)	Red	R		-	2.1	2.5	20	-	100	-	620	625	630

*1 Tolerance of measurements of chromaticity coordinate is ±10%

*2 Tolerance of measurements of dominant wavelength is ±1nm

*3 Tolerance of measurements of luminous intensity is ±15%

*4 Tolerance of measurements of forward voltage is±0.1V

0.39 Inch Single Digit Display
OSL10391-IX (Common Anode type)
OSL10391-LX (Common Cathode type)

■ Package Dimensions and Pin Function

**OSL10391-IX
(Common Anode type)**

Note:
1, Unit : mm (Tolerance: ±0.25mm unless otherwise noted)
2, The slope angle of any PIN may be ±5.0° Max

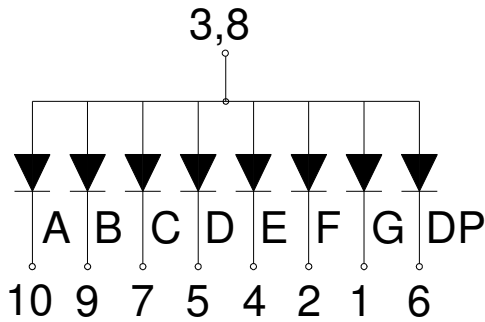
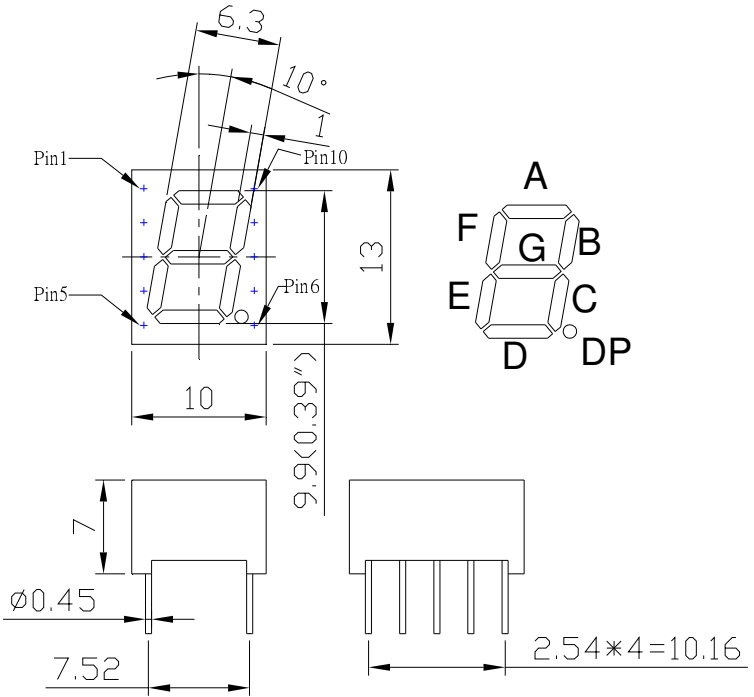

**OSL10391-LX
(Common Cathode type)**

Note:
1, Unit : mm (Tolerance: ±0.25mm unless otherwise noted)
2, The slope angle of any PIN may be ±5.0° Max

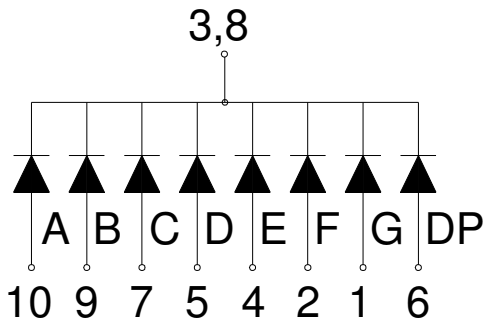
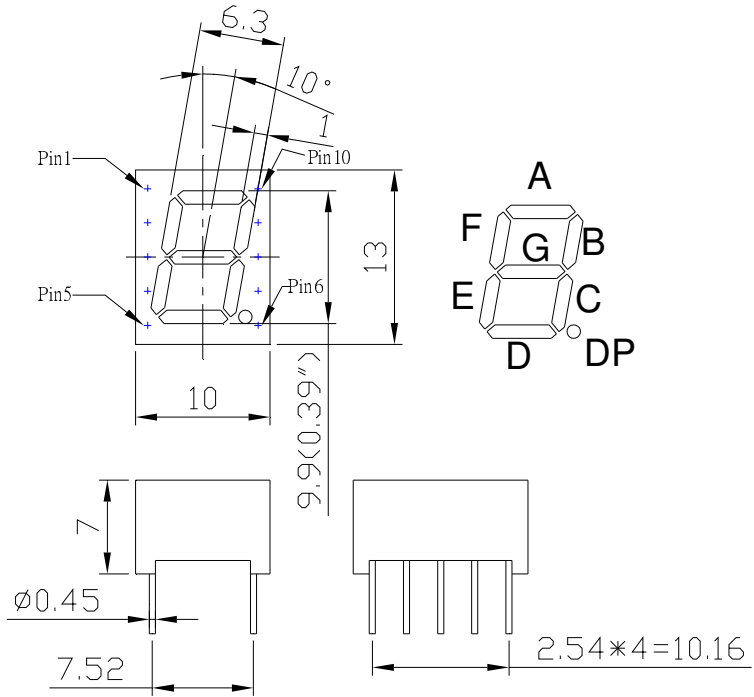

X-ON Electronics

Largest Supplier of Electrical and Electronic Components

Click to view similar products for [Optosupply](#) manufacturer:

Other Similar products are found below :

[OECCDD01-300](#) [OECCDD02-300](#) [OECCDD02-350](#) [OECCDD02-450](#) [OECCDD02-600](#) [OECCDD02-700](#) [OEHW2030GF](#) [OEHW2045GF](#)
[OEHW2060GF](#) [OEHW2090GF](#) [OKLEDT02406A](#) [OKLEDT3050G5V](#) [OKLEDT3050M3V](#) [OKLEDT3050RBV](#) [OKLEDT3050RBW](#)
[OKLEDT3050RPV](#) [OKLEDT3050RPW](#) [OKLEDT3100B5](#) [OKLEDT3100G8](#) [OKLEDT3100M3](#) [OKLEDT3100M4](#) [OKLEDT3100R6](#)
[OKLEDT3100W6](#) [OKLEDT3100WA](#) [OKLEDT3100Y5](#) [OKLEDT31203A](#) [OKLEDT5050G5V](#) [OKLEDT5050G5W](#) [OKLEDT5050RPW](#)
[OKLEDT5050TAV](#) [OKLEDT5050TAW](#) [OKLEDT5050W6P](#) [OKLEDT5050WAV](#) [OKLEDT5050WAW](#) [OKLEDT50606A](#)
[OKLEDT50606B](#) [OKLEDT51005A](#) [OKLEDT5100B5](#) [OKLEDT5100G8](#) [OKLEDT5100M3](#) [OKLEDT5100M4](#) [OKLEDT5100R6](#)
[OKLEDT5100W6](#) [OKLEDT5100WA](#) [OKLEDT5100Y5](#) [OKLEDT51203A](#) [OKLEDT51206A](#) [OKLEDT8050G5W](#) [OKLEDT8050M3V](#)
[OKLEDT8050R5V](#)