

■Description

This LED builds with internal resistor to operate with wide operation voltage of DC3-15V.

■Outline Dimension

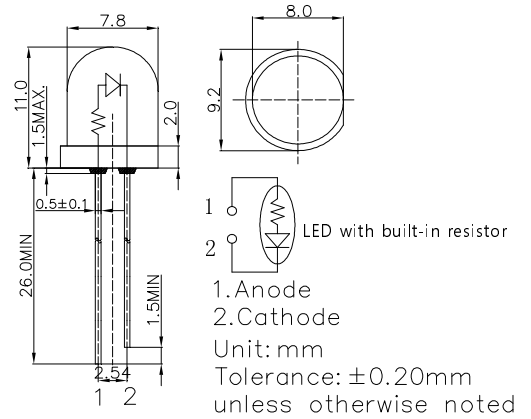

■Features

- Wide Input Voltage
- Cost Saving and Space Saving
- Diffused Type
- Single Color

■Applications

- Toys/Game/Audio
- TTL/Cmos Compatible
- Arduino/Pi Pico/Steam Kit
- Other Electronics Products

■Directivity

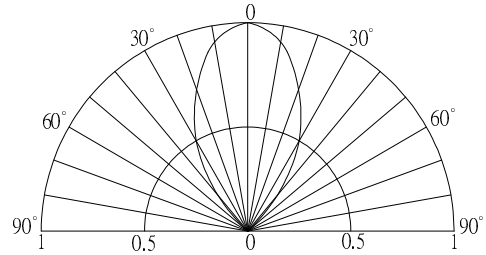

■Absolute Maximum Rating

(Ta=25°C)

Item	Symbol	Value	Unit
DC Forward Voltage	V _F	15	V
Reverse Voltage	V _R	12	V
Power Dissipation	P _D	190	mW
Operating Temperature	Topr	-30 ~ +85	°C
Storage Temperature	Tstg	-40~ +100	°C
Lead Soldering Temperature	Tsol	260°C/5sec	-

■Optical Characteristic Curves

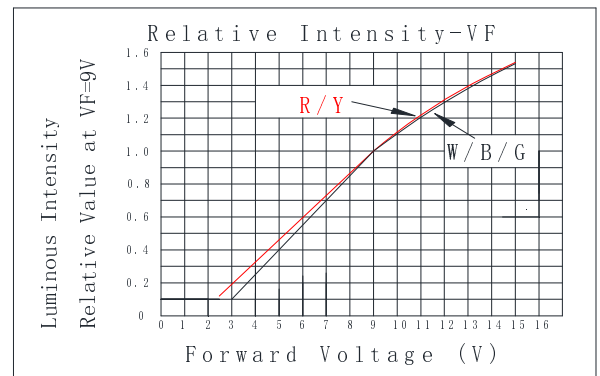

■Electrical -Optical Characteristics

(Ta=25°C)

8mm Multi-Voltage LED						
LED P/N	OSR58164A-VV	OSY58164A-VV	OSB58164A-VV	OSG58164A-VV	OSM58162A-VV	OSW58162A-VV
Light Color	Red	Yellow	Blue	Pure Green	Warm White	Cool White
Lens Color	Red Diffused	Yellow Diffused	Blue Diffused	Green Diffused	White Diffused	White Diffused
Wavelength*1/Color Temperature*2	620-630nm	585-595nm	465-475m	520-530nm	2700-3300K	8500-18000K
Luminous Intensity(typ.)*3	150mcd	150mcd	100mcd	400mcd	400mcd	400mcd
Forward Voltage(typ.)	9V	9V	9V	9V	9V	9V
Forward Current(typ.)	8mA	8mA	7.5mA	7.5mA	7.5mA	7.5mA
Viewing Angle(typ.)	60°	60°	60°	60°	60°	60°

*1 Tolerance of measurements of dominant wavelength is ±1nm

*2 Tolerance of measurements of color temperature is ±10%

*3 Tolerance of measurements of luminous intensity is ±15%

X-ON Electronics

Largest Supplier of Electrical and Electronic Components

Click to view similar products for [Optosupply](#) manufacturer:

Other Similar products are found below :

[OSB5SA5111A-CRLED16](#) [OSB5SA83C1A](#) [OSX10201-YGR1](#) [OS5YKP5111A](#) [OS5YPM8131A](#) [OS5YAA5HA4D-1-ST](#) [OS6OGA5B61P](#)
[OSW5DK5A31A-CRLED18](#) [OSY5PA5A31A-1MA](#) [OSB4YU39B4B](#) [OSO5JA3FE1B-12V](#) [OKLEDT30606A](#) [OSPT9054X3A](#)
[OKLEDT5050RPW](#) [OSL10564-IB](#) [OSO5PA58A1B-12V](#) [OKLEDT8050G5W](#) [OKLEDT8050RPW](#) [OSGGD251A5A](#) [OKLEDT3050RBW](#)
[OSYYP251A5A](#) [OKLEDT5050B5W](#) [OSB5DA3HA1F](#) [OSYBP2A131A](#) [OKLEDT3050RBV](#) [OKLEDT3050WAW](#) [OSL12306-16-IRA](#)
[OSY5MP5A34A-6.8HZ](#) [OKLEDT5050RBV](#) [OKLEDT8050RBV](#) [OKLEDT3050RPW](#) [OKLEDT5050WAV](#) [OSWRP23962B](#)
[OKLEDT5050TAW](#) [OKLEDT8050G5V](#) [OKLEDT8050WAW](#) [OSY5MSA131A](#) [OSXD2201-AGA](#) [OKLEDT3050RPV](#) [OKLEDT5050RBW](#)
[OSL10601-IRA](#) [OSCM4TS4C1A](#) [OSM5XAHEE1E](#) [OS6OGA3131P](#) [OSL10564-IYG](#) [OSO5PA56A1A-CRLED14](#) [OSRGH23NE2A](#)
[OST1MCA132A](#) [OKLEDT31206A](#) [OSPTYJ53X2T](#)