

Silicon Carbide (SiC) Schottky Diode – EliteSiC, 20 A, 1200 V, D3, TO-247-3L

NDSH20120CDN

Description

Silicon Carbide (SiC) Schottky Diodes use a completely new technology that provides superior switching performance and higher reliability compared to Silicon. No reverse recovery current, temperature independent switching characteristics, and excellent thermal performance sets Silicon Carbide as the next generation of power semiconductor. System benefits include highest efficiency, faster operating frequency, increased power density, reduced EMI, and reduced system size and cost.

Features

- Max Junction Temperature 175°C
- Avalanche Rated 49 mJ
- High Surge Current Capacity
- Positive Temperature Coefficient
- Ease of Paralleling
- No Reverse Recovery / No Forward Recovery
- This Device is Halide Free and RoHS Compliant with Exemption 7a, Pb-Free 2LI (on second level interconnection)

Applications

- General Purpose
- SMPS, Solar Inverter, UPS
- Power Switching Circuits

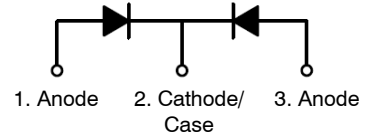

Schottky Diode

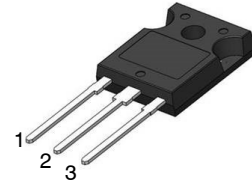

TO-247-3LD
 CASE 340CX

MARKING DIAGRAM

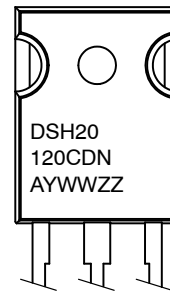

DSH20120CDN	= Specific Device Code
A	= Assembly Plant Code
YWW	= Date Code (Year & Week)
ZZ	= Lot Code

ORDERING INFORMATION

See detailed ordering and shipping information on page 2 of this data sheet.

NDSH20120CDN

ABSOLUTE MAXIMUM RATINGS ($T_J = 25^\circ\text{C}$ unless otherwise noted) (per leg)

Symbol	Parameter	Value	Unit	
V_{RRM}	Peak Repetitive Reverse Voltage	1200	V	
E_{AS}	Single Pulse Avalanche Energy (Note 1)	49	mJ	
I_F	Continuous Rectified Forward Current @ $T_C < 145^\circ\text{C}$	10*/20**	A	
	Continuous Rectified Forward Current @ $T_C < 135^\circ\text{C}$	12*/24**		
$I_{F, Max}$	Non-Repetitive Peak Forward Surge Current	$T_C = 25^\circ\text{C}, 10 \mu\text{s}$	546	A
		$T_C = 150^\circ\text{C}, 10 \mu\text{s}$	459	A
$I_{F, SM}$	Non-Repetitive Forward Surge Current	Half-Sine Pulse, $t_p = 8.3 \text{ ms}$	59	A
$I_{F, RM}$	Repetitive Forward Surge Current	Half-Sine Pulse, $t_p = 8.3 \text{ ms}$	31	A
P_{tot}	Power Dissipation	$T_C = 25^\circ\text{C}$	94	W
		$T_C = 150^\circ\text{C}$	16	W
T_J, T_{STG}	Operating and Storage Temperature Range	-55 to +175	$^\circ\text{C}$	

Stresses exceeding those listed in the Maximum Ratings table may damage the device. If any of these limits are exceeded, device functionality should not be assumed, damage may occur and reliability may be affected.

*Per leg.

** Per device.

1. E_{AS} of 49 mJ is based on starting $T_J = 25^\circ\text{C}$, $L = 0.5 \text{ mH}$, $I_{AS} = 14 \text{ A}$, $V = 50 \text{ V}$.

THERMAL CHARACTERISTICS (per leg)

Symbol	Parameter	Value	Unit
$R_{\theta JC}$	Thermal Resistance, Junction to Case, Max	1.6*/0.65**	$^\circ\text{C/W}$
$R_{\theta JA}$	Thermal Resistance, Junction to Ambient, Max	40	$^\circ\text{C/W}$

*Per leg.

** Per device.

ELECTRICAL CHARACTERISTICS ($T_J = 25^\circ\text{C}$ unless otherwise noted) (per leg)

Symbol	Parameter	Test Condition	Min	Typ	Max	Unit
V_F	Forward Voltage	$I_F = 10 \text{ A}, T_J = 25^\circ\text{C}$	-	1.39	1.75	V
		$I_F = 10 \text{ A}, T_J = 125^\circ\text{C}$	-	1.68	-	
		$I_F = 10 \text{ A}, T_J = 175^\circ\text{C}$	-	1.94	-	
I_R	Reverse Current	$V_R = 1200 \text{ V}, T_J = 25^\circ\text{C}$	-	1	200	μA
		$V_R = 1200 \text{ V}, T_J = 125^\circ\text{C}$	-	3	200	
		$V_R = 1200 \text{ V}, T_J = 175^\circ\text{C}$	-	8	200	
Q_C	Total Capacitive Charge	$V = 800 \text{ V}$	-	46	-	nC
C	Total Capacitance	$V_R = 1 \text{ V}, f = 100 \text{ kHz}$	-	680	-	pF
		$V_R = 400 \text{ V}, f = 100 \text{ kHz}$	-	41	-	
		$V_R = 800 \text{ V}, f = 100 \text{ kHz}$	-	32	-	

Product parametric performance is indicated in the Electrical Characteristics for the listed test conditions, unless otherwise noted. Product performance may not be indicated by the Electrical Characteristics if operated under different conditions.

ORDERING INFORMATION

Part Number	Top Marking	Package	Shipping
NDSH20120CDN	DSH20120CDN	TO-247-3LD (Pb-Free / Halogen Free)	30 Units / Tube

TYPICAL CHARACTERISTICS ($T_J = 25^\circ\text{C}$ unless otherwise noted)

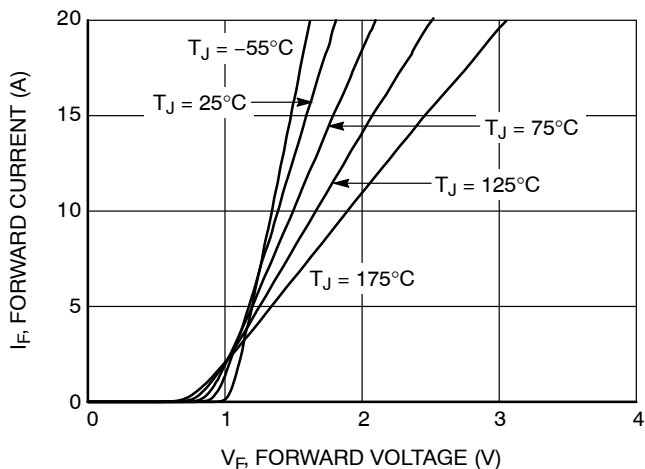

Figure 1. Forward Characteristics

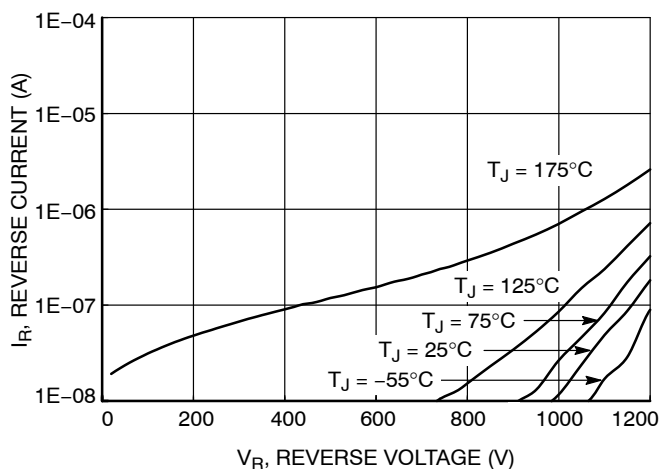

Figure 2. Reverse Characteristics

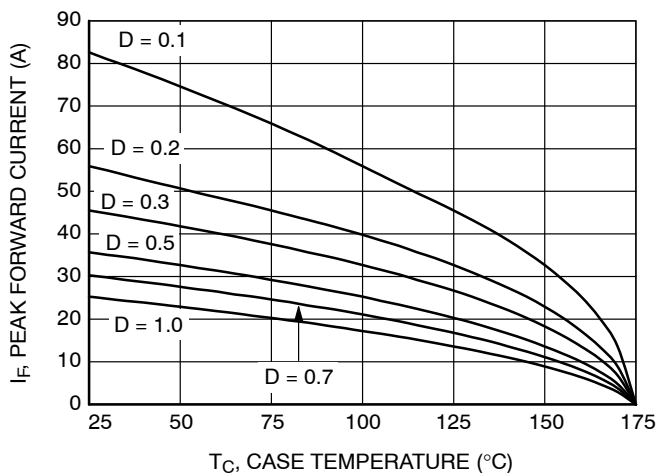

Figure 3. Current Derating

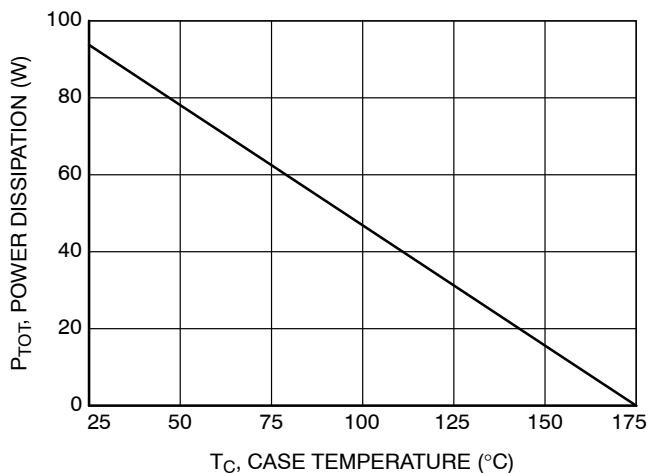

Figure 4. Power Derating

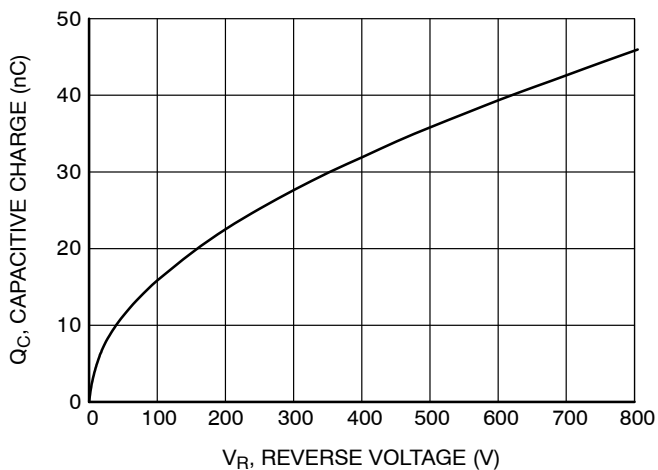

Figure 5. Capacitive Charge vs. Reverse Voltage

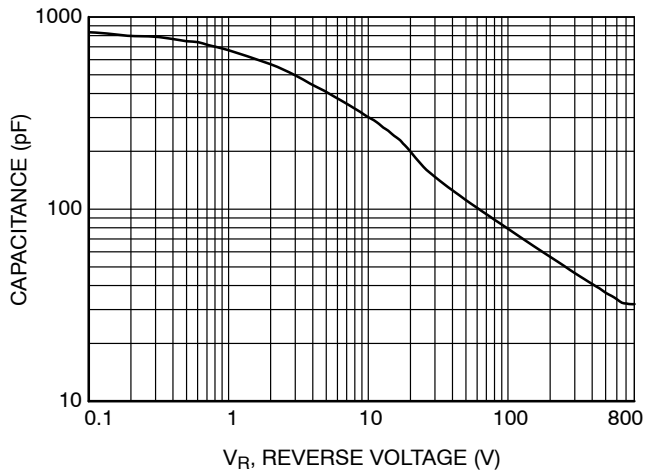

Figure 6. Capacitive vs. Reverse Voltage

TYPICAL CHARACTERISTICS ($T_J = 25^\circ\text{C}$ unless otherwise noted)

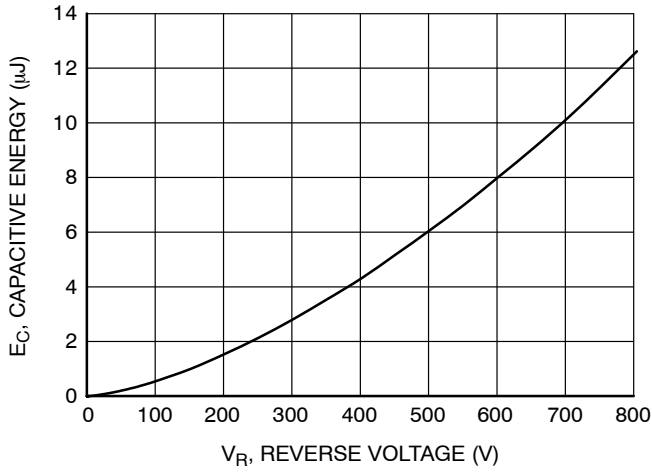

Figure 7. Capacitance Stored Energy

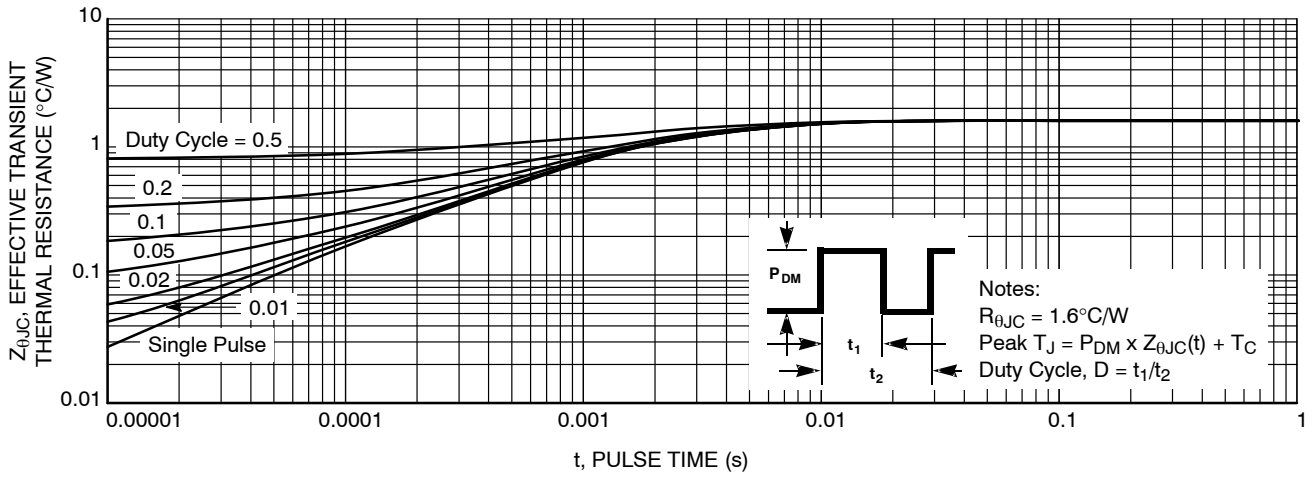
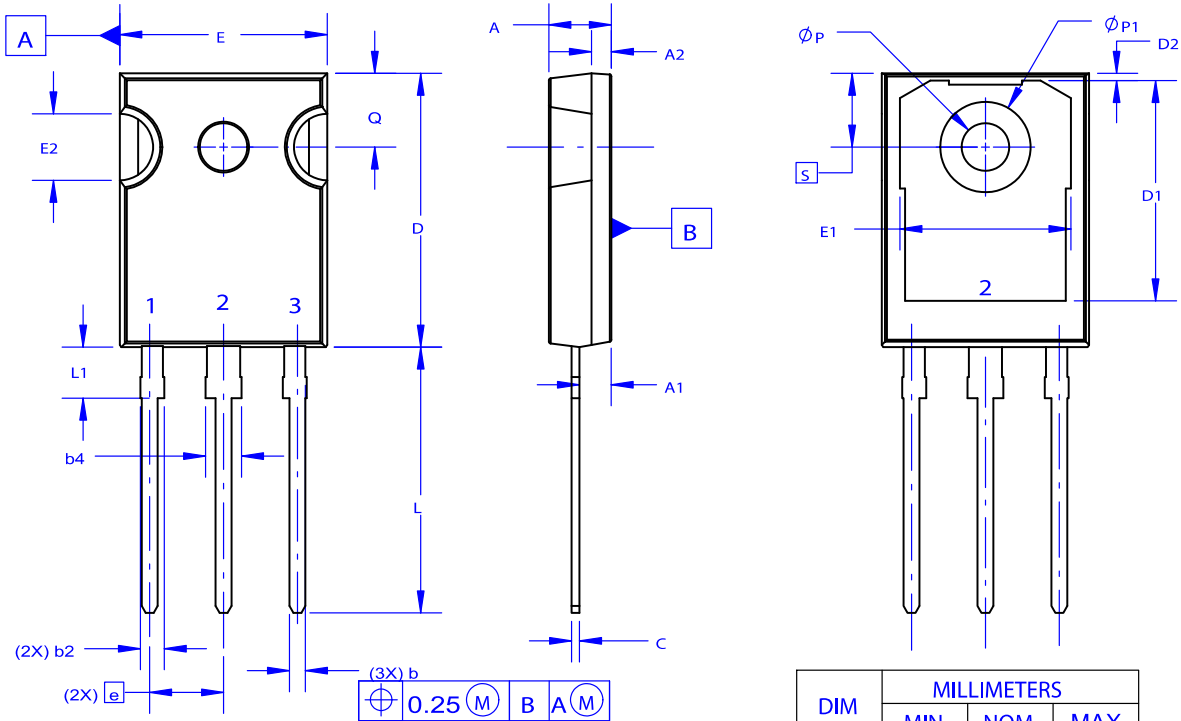
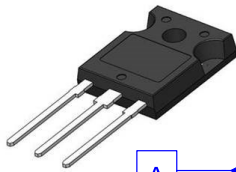

Figure 8. Junction-to-Case Transient Thermal Response Curve

TO-247-3LD
CASE 340CX
ISSUE A

DATE 06 JUL 2020



NOTES: UNLESS OTHERWISE SPECIFIED.

- A. DIMENSIONS ARE EXCLUSIVE OF BURRS, MOLD FLASH, AND TIE BAR EXTRUSIONS.
- B. ALL DIMENSIONS ARE IN MILLIMETERS.
- C. DRAWING CONFORMS TO ASME Y14.5 - 2009.
- D. DIMENSION A1 TO BE MEASURED IN THE REGION DEFINED BY L1.
- E. LEAD FINISH IS UNCONTROLLED IN THE REGION DEFINED BY L1.

GENERIC MARKING DIAGRAM*



- XXXXX = Specific Device Code
- A = Assembly Location
- Y = Year
- WW = Work Week
- G = Pb-Free Package

*This information is generic. Please refer to device data sheet for actual part marking. Pb-Free indicator, "G" or microdot "▪", may or may not be present. Some products may not follow the Generic Marking.

DIM	MILLIMETERS		
	MIN	NOM	MAX
A	4.58	4.70	4.82
A1	2.20	2.40	2.60
A2	1.40	1.50	1.60
D	20.32	20.57	20.82
E	15.37	15.62	15.87
E2	4.96	5.08	5.20
e	~	5.56	~
L	19.75	20.00	20.25
L1	3.69	3.81	3.93
ØP	3.51	3.58	3.65
Q	5.34	5.46	5.58
S	5.34	5.46	5.58
b	1.17	1.26	1.35
b2	1.53	1.65	1.77
b4	2.42	2.54	2.66
c	0.51	0.61	0.71
D1	13.08	~	~
D2	0.51	0.93	1.35
E1	12.81	~	~
ØP1	6.60	6.80	7.00

DOCUMENT NUMBER:	98AON93302G	Electronic versions are uncontrolled except when accessed directly from the Document Repository. Printed versions are uncontrolled except when stamped "CONTROLLED COPY" in red.
DESCRIPTION:	TO-247-3LD	PAGE 1 OF 1

onsemi and Onsemi are trademarks of Semiconductor Components Industries, LLC dba onsemi or its subsidiaries in the United States and/or other countries. onsemi reserves the right to make changes without further notice to any products herein. onsemi makes no warranty, representation or guarantee regarding the suitability of its products for any particular purpose, nor does onsemi assume any liability arising out of the application or use of any product or circuit, and specifically disclaims any and all liability, including without limitation special, consequential or incidental damages. onsemi does not convey any license under its patent rights nor the rights of others.

X-ON Electronics

Largest Supplier of Electrical and Electronic Components

Click to view similar products for [SiC Schottky Diodes](#) category:

Click to view products by [ON Semiconductor](#) manufacturer:

Other Similar products are found below :

[C3D02060F](#) [C3D04065E](#) [C3D10060G](#) [C4D02120A](#) [C4D20120D](#) [C3D03060A](#) [C3D04060A](#) [C3D08065A](#) [C3D10060A](#) [C3D10065A](#)
[C3D16060D](#) [C4D10120D](#) [C3D08065I](#) [C3D20065D](#) [C4D10120A](#) [C4D15120A](#) [C4D20120A](#) [C4D30120D](#) [C4D40120D](#) [BSDB10S65E6](#)
[BSDD10G65E2](#) [BSDD10S65E6](#) [BSDH06G65E2](#) [BSDH08G65E2](#) [BSDH10S65E6](#) [DSC04A065LP-13](#) [DSC04C065LP-13](#) [DSC06A065LP-13](#)
[DSC08A065LP-13](#) [DSC10A065LP-13](#) [SI20C065D2](#) [SI20C065CD2](#) [SICW20C065](#) [GD60MPS17H](#) [GD25MPS17H](#) [GD30MPS12H](#)
[GD50MPS12H](#) [GD05MPS17H](#) [GD02MPS12E](#) [GD10MPS12A](#) [GD2X75MPS17N](#) [GE04MPS06A](#) [GD10MPS12E](#) [GE04MPS06E-TR](#)
[GE06MPS06E-TR](#) [GE08MPS06E-TR](#) [GE10MPS06E-TR](#) [GE12MPS06A](#) [GE12MPS06E-TR](#) [GE04MPS06Q-TR](#)