

LOW-PROFILE SLIDE SWITCHES

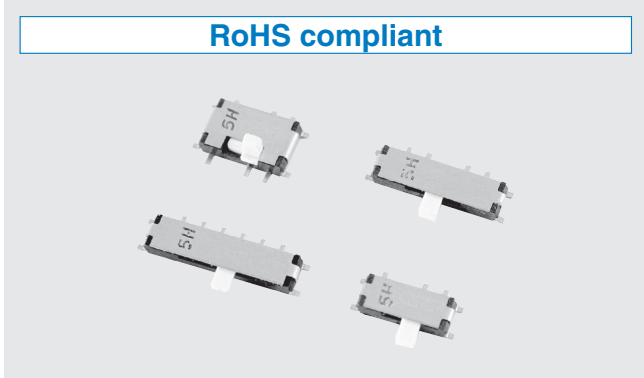

RoHS compliant



FEATURES

- Low-profile of 1.4 mm
- RoHS compliant

APPLICATIONS

- Mobile stereo · LCD TV · Camcorder

INTERNAL STRUCTURE

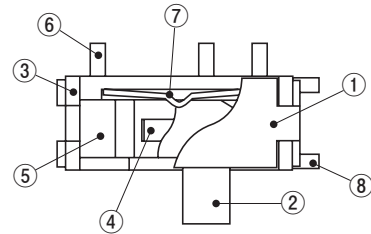

Part name	Material	Flammability
① Cover	Nickel silver	—
② Slider	Polyamide	UL94V-0
③ Housing	Liquid crystal polymer	
④ Slider contact	Copper alloy, Gold-plated	—
⑤ Fixed contact		
⑥ Terminal pin		
⑦ Click spring	Stainless steel (SUS 301)	—
⑧ Ground terminal	Nickel silver	

PART NUMBER DESIGNATION

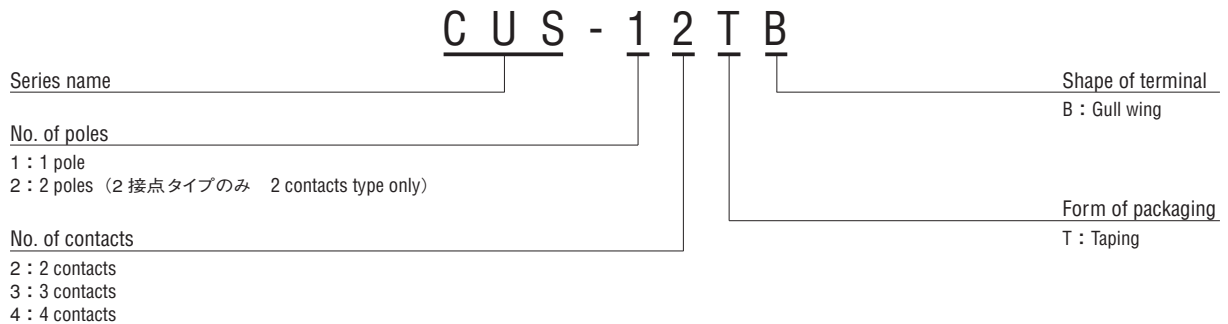

※ Please refer to the LIST OF PART NUMBERS when placing orders.

LIST OF PART NUMBERS

Schematic	No. of contacts	Shape of terminal	Form of packaging	Part number	Pieces in package
1	2	B Gull wing	Taping	CUS-12TB	2500 pcs./reel
	3			CUS-13TB	
	4			CUS-14TB	
2	CUS-22TB			1400 pcs./reel	

STANDARD SPECIFICATIONS

Operating temp. range	- 20 ~ 70 °C
Storage temp. range	- 40 ~ 85 °C
Sealing	Non washable
Net weight	Approx. 0.08 g (CUS-12) Approx. 0.10 g (CUS-13) Approx. 0.13 g (CUS-14) Approx. 0.11 g (CUS-22)

ELECTRICAL CHARACTERISTICS

Contact rating Non-switching Switching Minimum	DC50 V 100 mA DC4 V 300 mA DC20 mV 1 μA
Contact timing	Non-shorting
Contact resistance	70 m Ω maximum
Insulation resistance	100 M Ω minimum (DC 100 V)
Dielectric strength	AC100 V 60 s

MECHANICAL CHARACTERISTICS

No. of positions	2, 3, 4	
Stroke	1.5 mm	
Operating force	CUS-12 ^{※1}	2 ± 1.7 N {0.2 ± 0.17 kgf}
	CUS-13 ^{※2}	A → B : 1.5 ± 1.2 N {0.15 ± 0.12 kgf}
		B → C : 2 ± 1.7 N {0.2 ± 0.17 kgf}
	CUS-14 ^{※3}	C → B : 1.5 ± 1.2 N {0.15 ± 0.12 kgf}
		B → A : 2 ± 1.7 N {0.2 ± 0.17 kgf}
		A → B : 1.5 ± 1.2 N {0.15 ± 0.12 kgf}
B → C : 2 ± 1.7 N {0.2 ± 0.17 kgf}		
CUS-22 ^{※4}	C → D : 2 ± 1.7 N {0.2 ± 0.17 kgf}	
	D → C : 1.5 ± 1.2 N {0.15 ± 0.12 kgf}	
Stop strength	C → B : 2 ± 1.7 N {0.2 ± 0.17 kgf}	
	B → A : 2 ± 1.7 N {0.2 ± 0.17 kgf}	
Stop strength	10 N {1.02 kgf} 15 s	
Solderability	245 ± 3 °C 2 ~ 3 s	
Soldering heat	Reflow peak : 250 ~ 255 °C	
	Manual soldering : 350 ± 10 °C 3 ~ 4 s	
Shear	5 N {0.5 kgf} 10 s	
Substrate bending	Width 90 mm, bend 3 mm, 5 s, 1 time	
Pull-off strength	5 N {0.5 kgf} 10 s	

{ } : Reference only

ENVIRONMENTAL CHARACTERISTICS

Vibration	(Amplitude) 1.5 mmor (Acceleration) 98 m/s ² , 10-500-10 Hz, 3 directions for 10 cycles each
Shock	490 m/s ² , 11 ms, 6 directions for 3 times each
Load life	Continuous load 10000 cycles, DC4 ± 0.5 V, 300 ± 10 mA
Humidity	40 °C, Relative humidity 90 ~ 95 %, 240 h, No load
High temp. exposure	85 °C, 96 h, No load
Low temp. exposure	- 40 °C, 96 h, No load
Thermal shock	- 40 (0.5 h) ~ 85 °C (0.5 h), 5 cycles

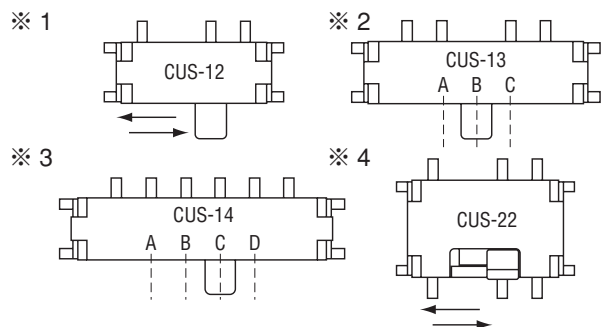

CUS

LOW-PROFILE SLIDE SWITCHES

OUTLINE DIMENSIONS

Unless otherwise specified, tolerance : ± 0.2 (Unit : mm)

● CUS-12B

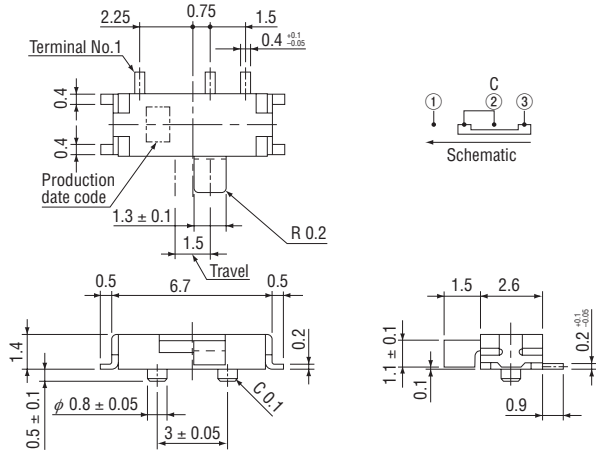

● CUS-13B

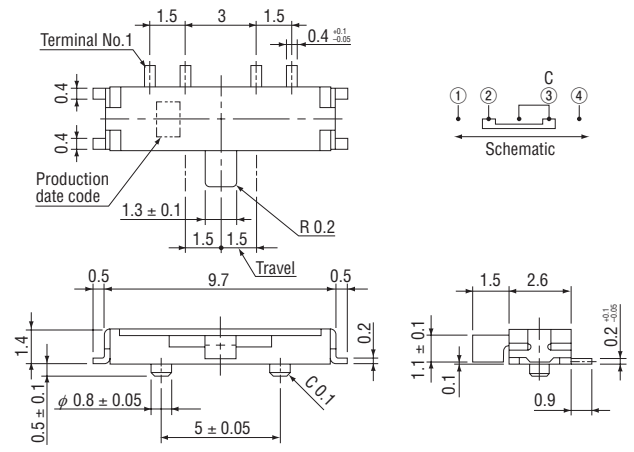

● CUS-14B

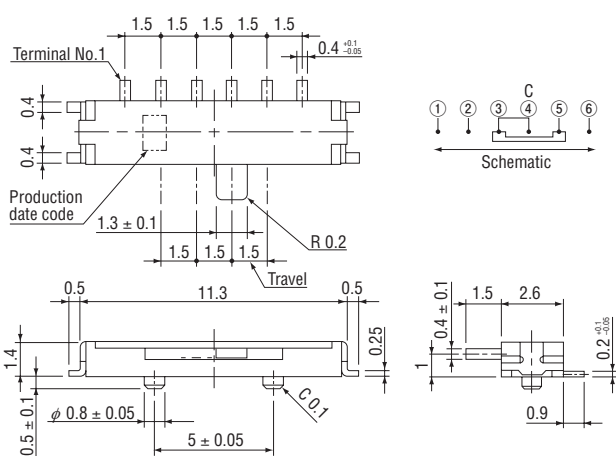

● CUS-22B

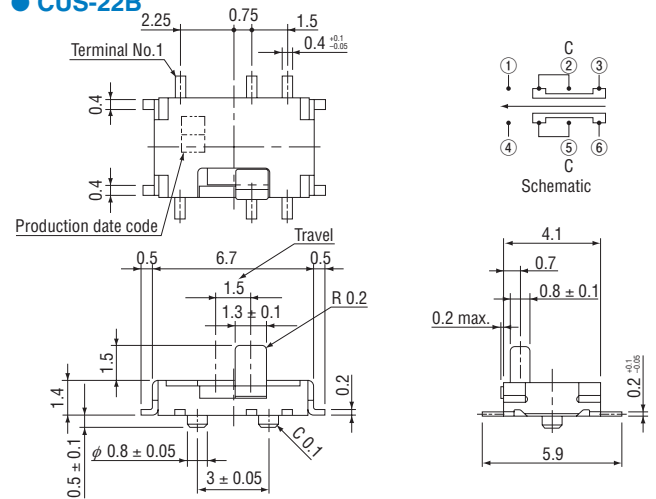

RECOMMENDED P.C.B. PAD OUTLINE DIMENSIONS

(Unit : mm)

● CUS-12B

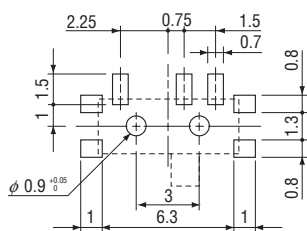

● CUS-13B

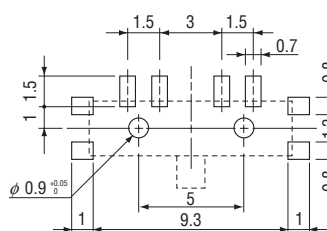

● CUS-14B

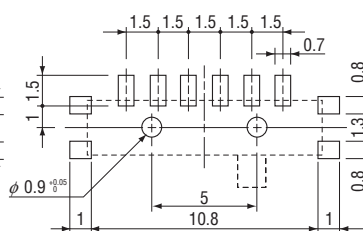

● CUS-22B

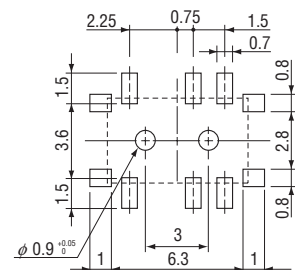

PACKAGING SPECIFICATIONS

Taping version is packaged in 2500 pcs. per reel (1400 pcs. for CUS-22).

Taping version is boxed with 1 reel (2500 pcs. or 1400 pcs.).
Maximum number of consecutive missing pieces = 2. Leader length and reel dimension are shown in the diagrams below.

Embossed tape dimensions

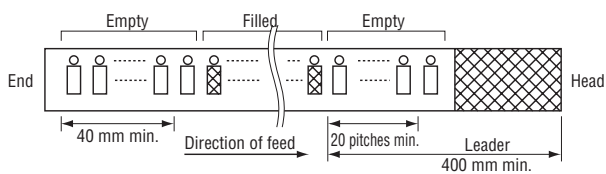

● CUS-12TB

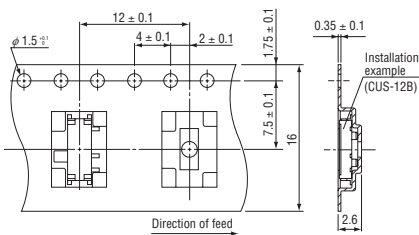

● CUS-13TB, CUS-14TB

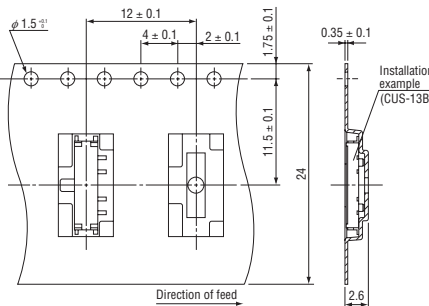

● CUS-22TB

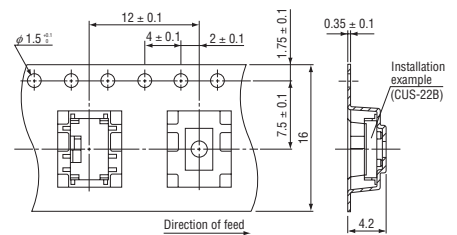

● Reel dimensions

(Unit: mm)

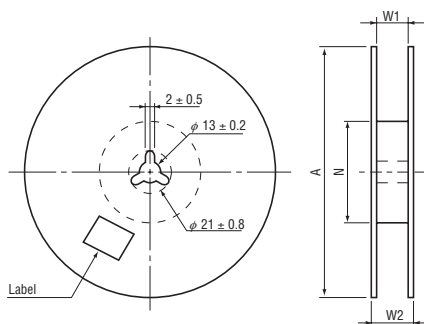

Part number	A	W ₁	W ₂	N
12TB, 22TB	φ 330 ± 2	17.4 ± 1	21.4 ± 1	φ 80 ± 1
13TB, 14TB	φ 330 ± 2	25.4 ± 1	29.4 ± 1	φ 80 ± 1

X-ON Electronics

Largest Supplier of Electrical and Electronic Components

Click to view similar products for [Slide Switches](#) category:

Click to view products by [Nidec Copal](#) manufacturer:

Other Similar products are found below :

[6-1437581-1](#) [M43R](#) [MHS123K15D](#) [MHS133K](#) [MHSS1104A](#) [MMD](#) [GH49S010001](#) [MSS12A](#) [EPS1PC1](#) [1825074-1](#) [1825160-3](#) [1825167-2](#)
[1825289-7](#) [K232CB](#) [25139NLDB](#) [25449NAH](#) [SLB1240R45](#) [1825078-1](#) [1825080-4](#) [1825269-1](#) [1825270-2](#) [STS141RA04](#) [T2215BEN506](#)
[GH46P000001](#) [GH46W000001](#) [GH49P010001](#) [25339NA](#) [M42A](#) [TG36P000000](#) [TG36P000050](#) [AYZ0202AG](#) [47227LFE](#) [49331L](#) [50208L](#)
[L203091MS02Q](#) [4-1437581-7](#) [X2225CR-437W](#) [49329L](#) [1101M1S3ZB8E2](#) [1-1437581-1](#) [MSS2225G04](#) [TG39W000000](#) [1825075-1](#)
[MSS42G](#) [TG36WS80065](#) [T105S1CWZBE](#) [SLB124145](#) [SLB1280R5](#) [SLB1340R45](#) [25136NLDB](#)