

100 mA, High Input Voltage LDO Linear Regulators ME6203 Series

General Description

ME6203 series are low-dropout linear voltage regulators with a built-in voltage reference module, error correction module and phase compensation module. ME6203 series are based on the CMOS process and allow high voltage input with low quiescent current. This series can deliver 100mA output current and allow an input voltage as high as 40V. This series has the function of internal feedback resistor setting from 2.1V to 12V. The output accuracy is $\pm 2\%$.

Selection Guide

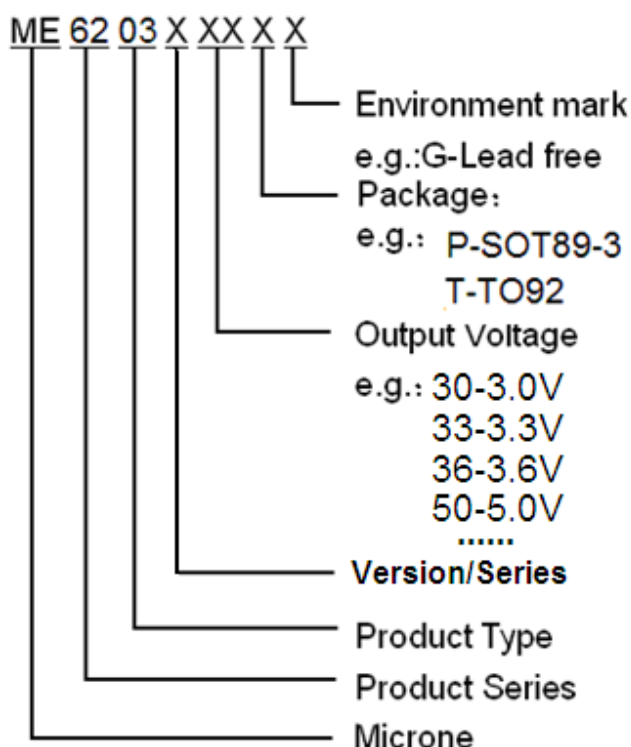

Features

- High output accuracy: $\pm 2\%$
- Input voltage: up to 40 V
- Output voltage: 2.1V ~ 12V
- Ultra-low quiescent current (Typ.= 3 μ A)
- Output Current: $I_{OUT} = 100\text{mA}$
(When $V_{IN} = 5.5\text{V}$ and $V_{OUT} = 3.3\text{V}$)
- Low temperature coefficient
- Ceramic capacitor can be used
- Package: SOT89-3、TO92、SOT23-3

Typical Application

- Electronic weighbridge
- SCM
- Phones, cordless phones
- Security Products
- Water meters, power meters

Typical Application Circuit

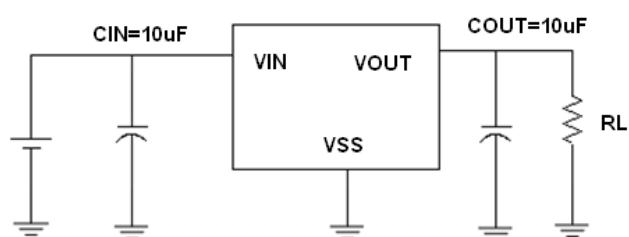

Suggesting : The circuit uses the electrolytic capacitors or tantalum capacitors in the best ,when it is applied in the high input voltage.

Pin Configuration

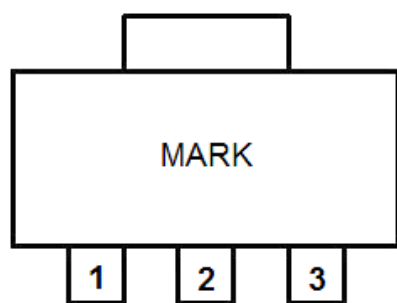

SOT89-3

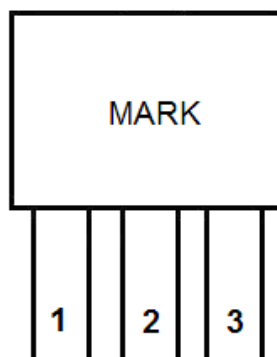

TO92

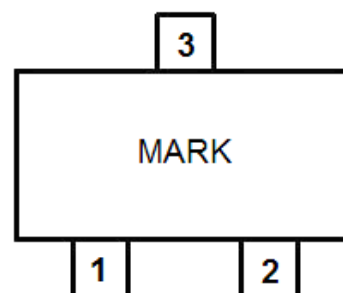

SOT23-3

Pin Assignment

ME6203AXX

Pin Number		Pin Name	Functions
SOT89-3 / TO92	SOT23-3		
1	1	V_{SS}	Ground
2	3	V_{IN}	Power Input
3	2	V_{OUT}	Output

Absolute Maximum Ratings

Parameter	Symbol	Ratings	Units
Input Voltage	V_{IN}	40	V
Output Current	I_{OUT}	150	mA
Output Voltage	V_{OUT}	$V_{SS}-0.3 \sim V_{IN}+0.3$	V
Power Dissipation	SOT89-3	500	mW
	TO92	500	mW
Operating Temperature Range	T_{OPR}	$-25 \sim +85$	$^{\circ}C$
Storage Temperature Range	T_{STG}	$-40 \sim +125$	$^{\circ}C$
Lead Temperature		$260^{\circ}C, 10sec$	

Block Diagram

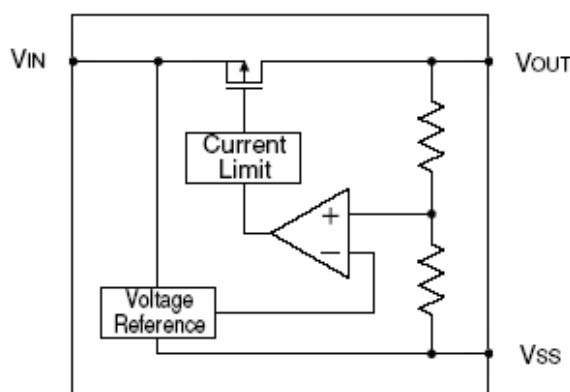

Electrical Characteristics

ME6203A33

($V_{IN} = V_{OUT} + 2.0V$, $C_{IN} = C_L = 10\mu F$, $T_a = 25^\circ C$, unless otherwise noted)

Parameter	Symbol	Conditions	Min.	Typ.	Max.	Units
Output Voltage	$V_{OUT(E)}$ (Note 2)	$I_{OUT} = 10mA$	X 0.98	$V_{OUT(T)}$ (Note 1)	X 1.02	V
Input Voltage	V_{IN}				40	V
Maximum Output Current	I_{OUT_max}	$V_{IN} = V_{OUT} + 2.2V$		100		mA
Load Regulation	ΔV_{OUT}	$V_{IN} = V_{OUT} + 2.2V$, $1mA \leq I_{OUT} \leq 100mA$		30	60	mV
Dropout Voltage (Note 3)	V_{DIF}	$I_{OUT} = 10mA$		0.22		V
		$I_{OUT} = 50mA$		1.1		V
Supply Current	I_{SS}	$V_{IN} = V_{OUT} + 2V$		3	4	μA
Line Regulations	$\frac{\Delta V_{OUT}}{\Delta V_{IN} \times V_{OUT}}$	$I_{OUT} = 1mA$ $V_{OUT} + 1V \leq V_{IN} \leq 40V$		0.04	0.1	%/V
Short-circuit Current	I_{SHORT}	$V_{OUT} = 0V$		20	40	mA
Temperature Coefficient	$\frac{\Delta V_{OUT}}{V_{OUT} \times \Delta T_a}$	$I_{OUT} = 10mA$ $-40^\circ C \leq T_a \leq 85^\circ C$		80		ppm/ $^\circ C$

Note :

- $V_{OUT(T)}$: Specified Output Voltage
- $V_{OUT(E)}$: Effective Output Voltage (ie. The output voltage when " $V_{OUT(T)} + 2.0V$ " is provided at the V_{IN} pin while maintaining a certain I_{OUT} value.)
- V_{DIF} : $V_{IN1} - V_{OUT(E)}$
 V_{IN1} : The input voltage when $V_{OUT(E)}$ appears as input voltage is gradually decreased.
 $V_{OUT(E)}$ = A voltage equal to 98% of the output voltage whenever an amply stabilized I_{OUT} and $\{V_{OUT(T)} + 2.2V\}$ is input.

Type Characteristics

(1) Output Voltage VS. Output Current (Ta = 25 °C)

ME6203A33 ($V_{IN}=V_{OUT}+2.2V$)

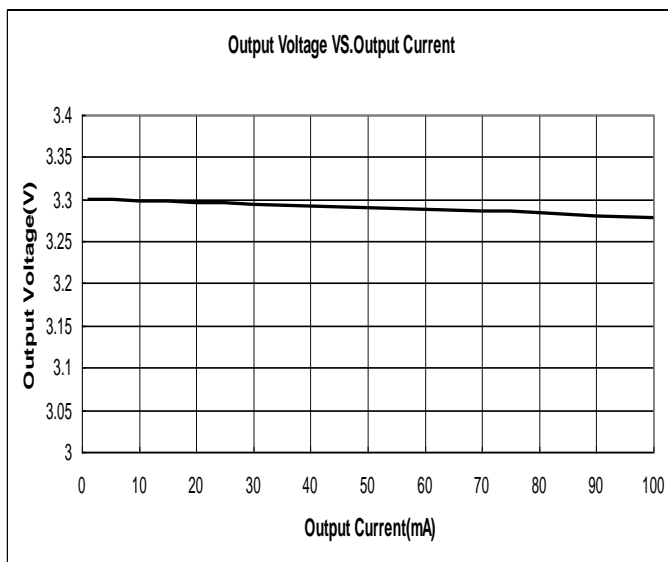

(2) Output Voltage VS. Input Voltage (Ta = 25 °C)

ME6203A33

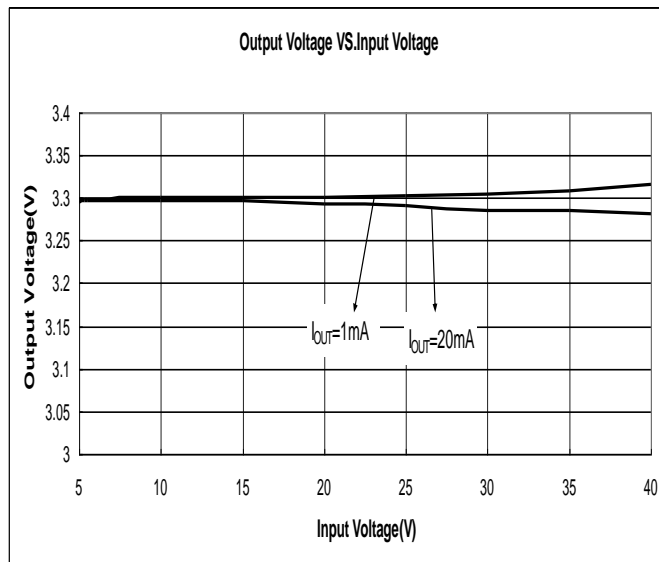

(3) Dropout Voltage VS. Output Current (Ta = 25 °C)

ME6203A33

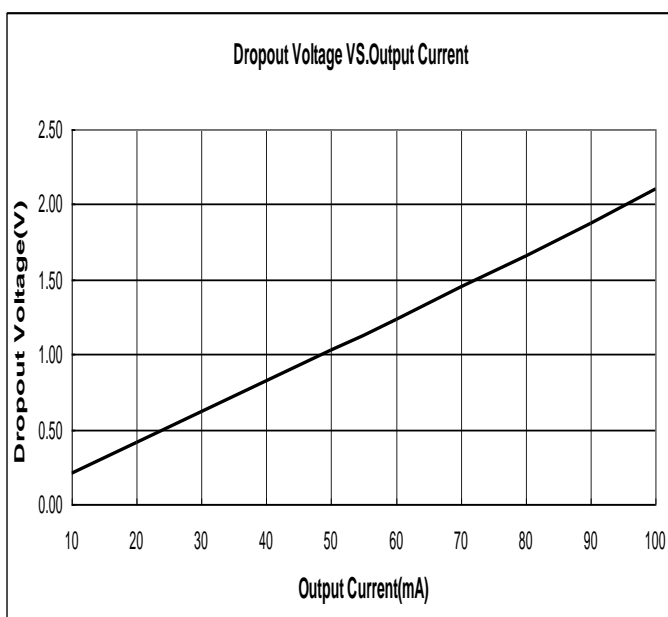

(4) Quiescent Current VS. Input Voltage (Ta = 25 °C)

ME6203A33

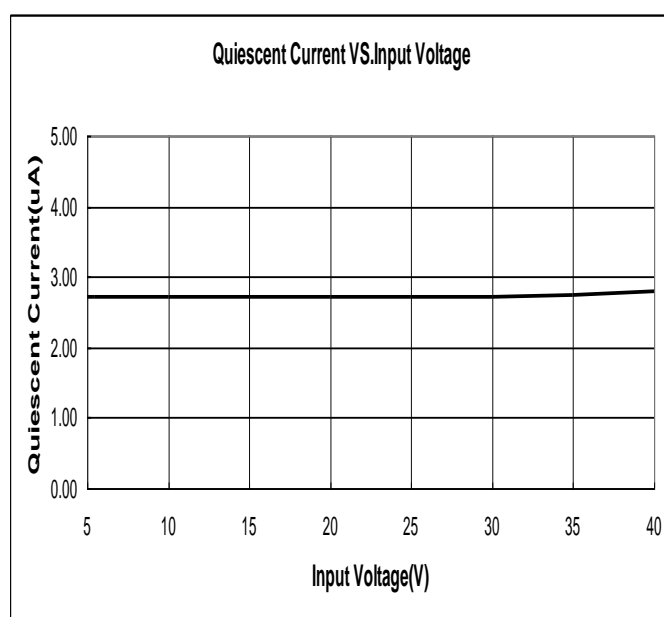

(5) Output Voltage VS. Temperature

ME6203A33 ($I_{OUT}=10mA$)

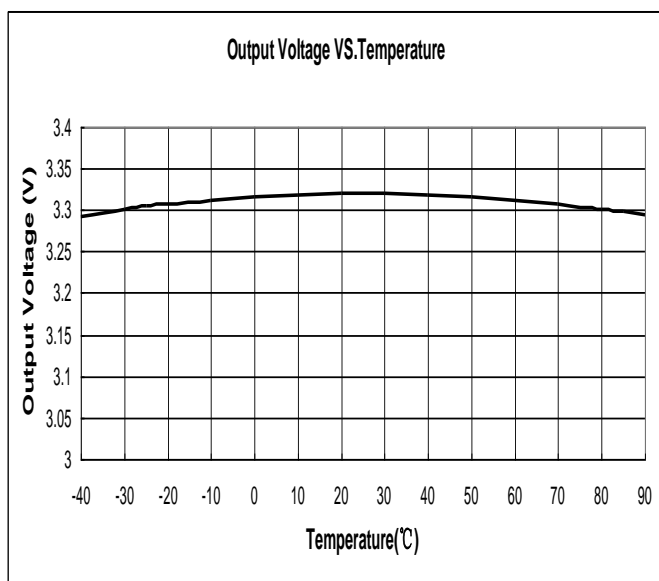

(6) Quiescent Current VS. Temperature

ME6203A33 ($V_{IN}=V_{OUT}+2.2V$)

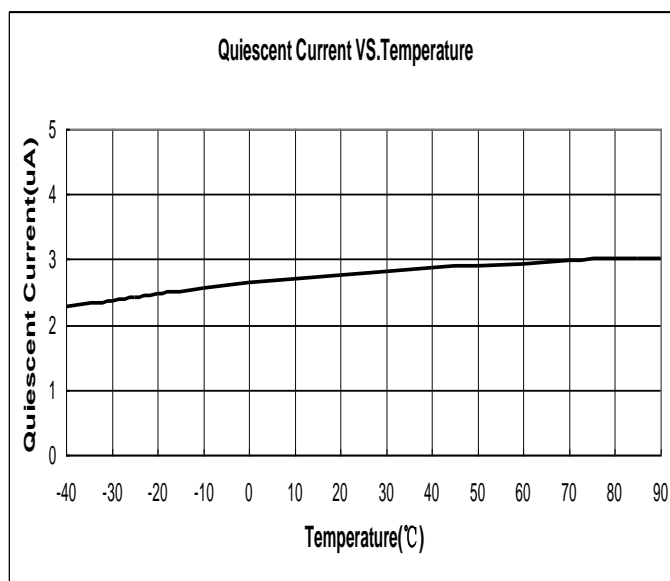

Packaging Information

● SOT89-3

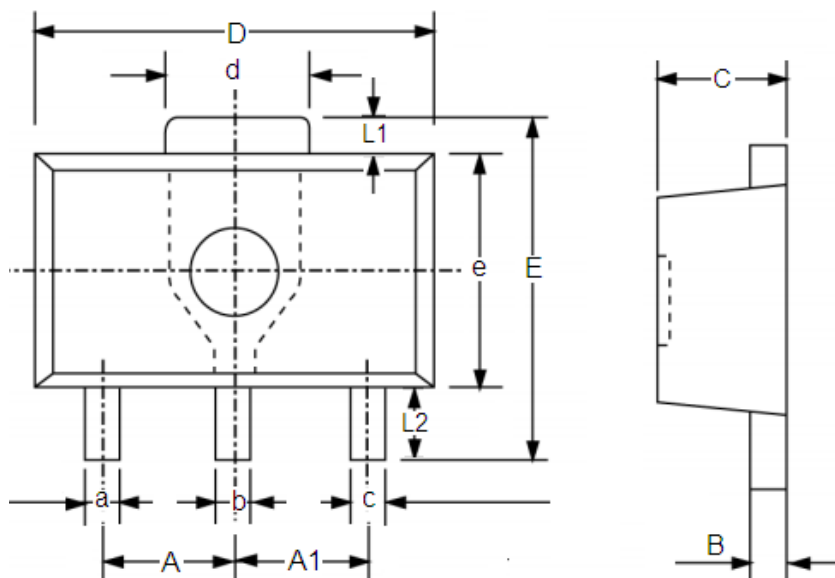

DIM	Millimeters		Inches	
	Min	Max	Min	Max
A	1.4	1.6	0.0551	0.0630
A1	1.4	1.6	0.0551	0.0630
a	0.36	0.48	0.0142	0.0189
b	0.41	0.53	0.0161	0.0209
c	0.36	0.48	0.0142	0.0189
d	1.4	1.75	0.0551	0.0689
B	0.38	0.43	0.015	0.0169
C	1.4	1.6	0.0551	0.0630
D	4.4	4.6	0.1732	0.181
E	-	4.25	-	0.1673
e	2.4	2.6	0.0945	0.1023
L1	0.4	-	0.0157	-
L2	0.8	-	0.0315	-

● TO-92

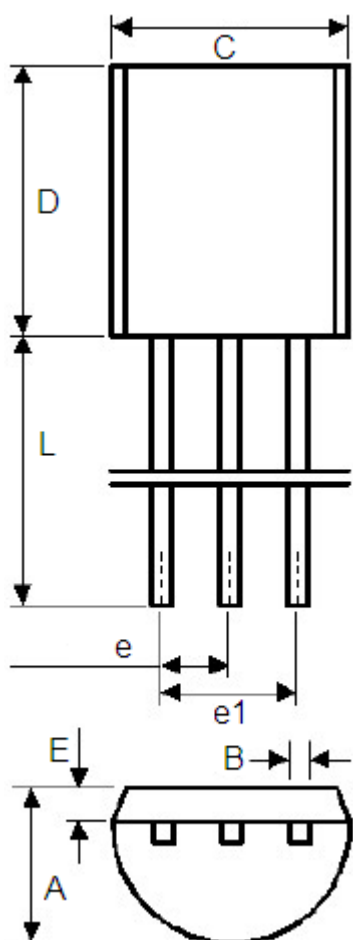

	Min	Max	Min	Max
A	3.4	3.8	0.13386	0.1496
B	0.3	0.5	0.0118	0.0197
C	4.4	4.8	0.1732	0.189
D	4.4	4.8	0.1732	0.189
E	0.9	1.5	0.0354	0.059
e	1.17	1.37	0.046	0.0539
e1	2.39	2.69	0.094	0.1059
L	12	16	0.4724	0.6299

● SOT23-3

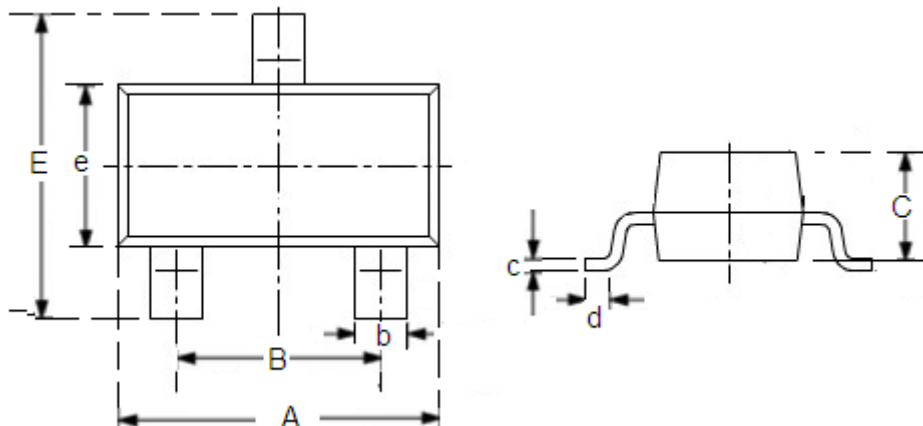

DIM	Millimeters		Inches	
	Min	Max	Min	Max
A	2.7	3.1	0.1063	0.122
B	1.7	2.1	0.0669	0.0827
b	0.35	0.5	0.0138	0.0197
C	1.0	1.2	0.0394	0.0472
c	0.1	0.25	0.0039	0.0098
d	0.2	-	0.0079	-
E	2.6	3.0	0.1023	0.1181
e	1.5	1.8	0.059	0.0708

- The information described herein is subject to change without notice.
- Nanjing Micro One Electronics Inc is not responsible for any problems caused by circuits or diagrams described herein whose related industrial properties, patents, or other rights belong to third parties. The application circuit examples explain typical applications of the products, and do not guarantee the success of any specific mass-production design.
- Use of the information described herein for other purposes and/or reproduction or copying without the express permission of Nanjing Micro One Electronics Inc is strictly prohibited.
- The products described herein cannot be used as part of any device or equipment affecting the human body, such as exercise equipment, medical equipment, security systems, gas equipment, or any apparatus installed in airplanes and other vehicles, without prior written permission of Nanjing Micro One Electronics Inc.
- Although Nanjing Micro One Electronics Inc exerts the greatest possible effort to ensure high quality and reliability, the failure or malfunction of semiconductor products may occur. The user of these products should therefore give thorough consideration to safety design, including redundancy, fire-prevention measures, and malfunction prevention, to prevent any accidents, fires, or community damage that may ensue.

X-ON Electronics

Largest Supplier of Electrical and Electronic Components

Click to view similar products for [Linear Voltage Regulators](#) category:

Click to view products by [Micro One](#) manufacturer:

Other Similar products are found below :

[LV56831P-E](#) [LV5684PVD-XH](#) [MCDTSA6-2R](#) [L7815ACV-DG](#) [PQ3DZ53U](#) [LV56801P-E](#) [TLE42794G](#) [L78L05CZ/1SX](#) [L78LR05DL-MA-E](#) [636416C](#) [714954EB](#) [BA033LBSG2-TR](#) [LV5680P-E](#) [L78M15CV-DG](#) [L79M05T-E](#) [TLS202A1MBVHTSA1](#) [L78LR05D-MA-E](#) [NCV317MBTG](#) [NTE7227](#) [LV5680NPVC-XH](#) [LT1054CN8](#) [MP2018GZD-5-Z](#) [MP2018GZD-33-Z](#) [MIC5281-3.3YMM](#) [MC78L06BP-AP](#) [TA48LS05F\(TE85L,F\)](#) [TA78L12F\(TE12L,F\)](#) [TC47BR5003ECT](#) [TCR2LN12,LF\(S](#) [TCR2LN28,LF\(S](#) [TCR2LN30,LF\(S](#) [TCR3DF295,LM\(CT](#) [TCR3DF40,LM\(CT](#) [BA178M20CP-E2](#) [L78M12ABDT](#) [LM7812SX/NOPB](#) [LR645N3-G-P003](#) [LR645N3-G-P013](#) [ZXTR2005P5-13](#) [SCD7812BTG](#) [TCR3DF335,LM\(CT](#) [ZXTR2012K-13](#) [TLE42994E V33](#) [ZXTR2008K-13](#) [ZXTR2005K-13](#) [L88R05DL-E](#) [ADP3300ARTZ-2.7RL7](#) [LM120K-15/883](#) [IFX54441LDVXUMA1](#) [LM317D2T-TR](#)