

cannon

CA-COM Industrial Connectors



ITT

ENGINEERED FOR LIFE



ITT Inc.

ITT is a diversified leading manufacturer of highly engineered critical components and customized technology solutions for the energy, transportation and industrial markets. Building on its heritage of innovation, ITT partners with its customers to deliver enduring solutions to the key industries that underpin our modern way of life. Founded in 1920, ITT is headquartered in White Plains, N.Y., with employees in more than 35 countries and sales in a total of approximately 125 countries. For more information, visit www.itt.com.

Our connector portfolio remains the most extensive in the industry, offering a reliable and cost effective range of interconnect solutions with the brands of Cannon, VEAM and BIW Connector Systems. Continuous investment in technology and research & development have enabled ITT to provide new, innovative products and solutions to markets including:



Transportation



Industrial / Instrumentation



Oil & Gas



Defense Vehicles



Commercial & Military Aerospace



Automotive



Computer, Telecom & Consumer Electronics

Our connector portfolio remains the most extensive in the industry, offering a reliable and cost effective range of interconnect solutions

Introduction to CA-COM

ITT Cannon's circular connector's series CA-COM and CA-COM-B are derivations of the connectors known as SAE-AS50151 (formerly MIL-DTL-5015) and VG95234. Initially designed for military aircraft and combat vehicle application the CA-COM versions have been modified especially for the utilization in various industrial areas. Connectors of both CA-COM series are intermateable and interchangeable with the corresponding types as per SAE-AS50151 and VG95234 as they offer the same mounting dimensions and contact arrangements. The entire CA-COM connector line is ROHS compliant.

Features and benefits

- The CA-COM standard version is featured by a threaded coupling system while the CA-COM-B types are coined by a "Reverse bayonet" coupling mechanism that offers exceptional vibration protection by a simple 120° turn. The CA-COM-B coupling unit is featured by roller bolts made of stainless steel rolling down the mating ramp, thus reducing coupling torque.
- Various backshell and adapter options, like PG metric gland and heatshrink boot are available amongst others.
- Insulators are made of high quality polychloroprene, which are good for temperatures up to 125°. This material is self-extinguishing, resistant against various fluids like gasoline, lubricants and other fluids of such nature (short time wetting only). In case of lifetime moistening FKM insulator material can be offered as an alternative.
- The contacts are made of copper alloy plated with hard silver finish good for at least 500 mating cycles. There are solder, crimp and PCB contacts in place. The crimp contacts offer a comprehensive range of termination reductions (see pages 41 and 42).
- All solder contacts are ROHS compliant due to a special passivation.

Contact us for detail or your request for a customized solution.

Vital Information:

2D and 3D drawings, connector specifications are available on ITT Cannon's web page: www.ittcannon.com
Please insert the full connector part number into the keyword search field.

Table of contents

| | |
|--|-------|
| How to use this catalogue..... | 6 |
| Product overview | 7 |
| Part number creation | 8–9 |
| Ordering reference | 10 |
| Contact arrangements..... | 11–15 |
| Mounting dimensions | 16 |
| Seperating and coupling dimensions | 17 |
| Wall mounting receptacles with endbells..... | 18–21 |
| Cable connecting plugs | 22–25 |
| Wall mounting receptacles | 26–29 |
| Straight Plugs..... | 30–33 |
| Right Angle Plugs | 34–36 |
| Accessories – Protective caps | 37–38 |
| Accessories | 39–40 |
| Contacts | 41–42 |
| Tooling..... | 43–44 |
| Product safety information | 45 |

How to use

This catalog is split in several sections that help you to

- Get an impression what this product is all about (Introduction)
- Get a general overview of all product lines (product overview)
- Get all required detail information (contact arrangements, product details)
- Get all required supporting products (accessories and tooling)

The fastest way to find your product of choice is to follow these steps

1 **Select your product** using either the “part number creation” or the “ordering reference” option

3 **Add accessories and tooling options** on the related pages. A connector assembly instruction is available upon request or visit www.ittcannon.com:
Enter Keyword "CA Bayonet Assembly Instruction"

2 **Use the detail pages** to better understand the available options like connector styles, contact arrangements and contacts options

4 **Use the contact information** on the back cover to contact us for further questions or to get advise on where you can purchase our products

Product overview

ELECTRICAL DATA

Contact Rating at 20°C (68°F), ambient temperature

| Contact size (AWG/metric) | Rated Current (A _{max}) ¹ |
|---------------------------|--|
| 16S/15S | 22 |
| 16/15 | 22 |
| 12 | 41 |
| 8/60/100 | 74 |
| 4/160 | 135 |
| 0/500 | 245 |

¹This applies only to the max. rated current for one contact. If several contacts in one contact arrangement are loaded with higher current the temperature may not exceed 125°C

Rated Current vs. Ambient Temperature

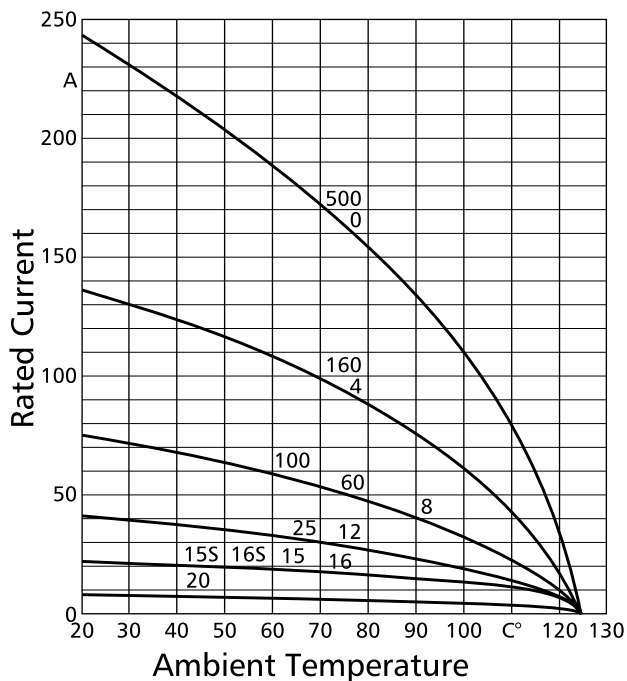

Contacts Resistance (Millivolt test)

| Contact size (AWG/metric) | Contact resistance mΩ max. |
|---------------------------|----------------------------|
| 16S/15S | 6,0 |
| 16/15 | 6,0 |
| 12/25 | 3,0 |
| 8/100 | 1,0 |
| 4/160 | 0,3 |
| 0/500 | 0,2 |

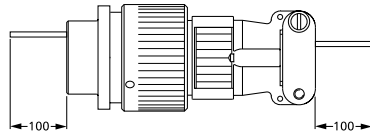

Insulation Resistance ≥ 1000 MΩ

Air and Creepage Path (min.)

| Voltage class | Instr. | A | D |
|-------------------|--------|-----|-----|
| Air path, mm | 0,7 | 1,1 | 2,8 |
| Creepage path, mm | 0,7 | 1,1 | 2,8 |

Operation Voltage

As according to specification these connectors are suitable for an operating voltage of 50V_{rms} (see Product safety information). However, this is only valid when the connectors are freely accessible during operation and consequently might be touchable.

Dimensions shown in mm | Specifications and dimensions subject to change

Test voltage

| Service rating | Test voltage V _{rms} |
|----------------|-------------------------------|
| Instruments | 1050 |
| A | 1600 |
| B | 4500 |
| D | 2500 |
| E | 3000 |

MECHANICAL FEATURES

Ambient temperature

-55/125°C (-67/257°F)

ENVIRONMENTAL SEALING Acc. to DIN EN 60068-1

Threaded: Up to IP 65 (in mated condition)

Bayonet: Up to IP 67 (in mated condition)

Mating Cycles min. 500

Min. Separating Force per Contact

| Contact size | | Separating force |
|--------------|--------|------------------|
| metric | AWG | N min |
| 15S/15 | 16S/16 | 1,0 |
| 25 | 12 | 1,5 |
| 60/100 | 8 | 3,0 |
| 160 | 4 | 4,0 |
| 500 | 0 | 8,5 |

Contact Retention Apply test force in mating direction

| Contact size | | Test force |
|--------------|--------|------------|
| metric | AWG | N |
| 15S/15 | 16S/16 | 35 |
| 25 | 12 | 55 |
| 60/100 | 8 | 80 |
| 160 | 4 | 90 |
| 500 | 0 | 95 |

Coupling Torque

The admissible coupling torque has to be tested under harnessed condition

| Shell size | Admissible torque | | |
|------------|--|----------|------------------------------|
| | Closing and opening (Nm _{max}) | | Opening (Nm _{min}) |
| | CA-COM | CA-COM-B | |
| 10SL | 3,0 | 1,7 | 0,15 |
| 12S | 2,8 | 2,5 | 0,23 |
| 14S | 5,9 | 3,6 | 0,35 |
| 16S/16 | 7,0 | 5,5 | 0,46 |
| 18 | 8,0 | 8,0 | 0,58 |
| 20 | 9,0 | 9,0 | 0,70 |
| 22 | 10,6 | 11,0 | 0,80 |
| 24 | 12,9 | 14,0 | 0,80 |
| 28 | 16,7 | 17,0 | 0,92 |
| 32 | 18,1 | 19,0 | 1,02 |
| 36 | 23,9 | 23,0 | 1,05 |





Materials

| | |
|-------------------|--|
| Shell | Aluminum alloy, Zinc die cast, nickel plated |
| Contacts | Copper alloy, silver plated |
| Insulator/Grommet | Polychloroprene |

Part number creation plug

Follow these steps to design your connector part number.

STEP 1 Select shell style (plug)

| Shell Style | Straight Plug | | Plug 90° | |
|-------------|---|---|--|---|
| | Bayonet | Threaded | Bayonet | Threaded |
| |  |  |  |  |
| | CA06COM-B | CA06COM | CA08COM-B | CA08COM |

STEP 2 Choose backshell

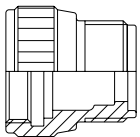
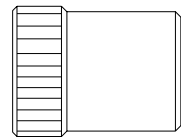
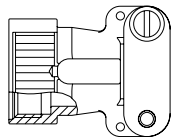
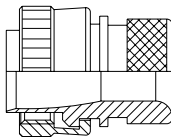
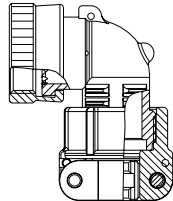
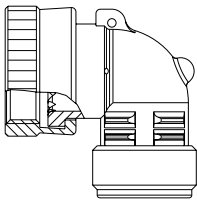
| Class F For Flex tube | Class PG; ME For PG or Metric cable glands | Class E General duty, strain relief | Class E Environmental, grommet seal, heat shrink boot adapter Mod. -03; -06 (bayonet), Mod. DN (threaded) | Class E, 90° General duty, strain relief | Class F, 90° For Flex tube |
|--|--|--|--|--|--|
|  |  |  |  |  |  |

STEP 3 Choose layout

see page 11–14 for layouts

STEP 4 Choose gender

P=pin S=socket

STEP 5 Choose rotation

see page 15 for rotation (omit for normal position)

STEP 6 Choose modification

see page 10 for modifications

Design your part number as per above steps







| CA-COM-B Example | STEP 1 Shell style | STEP 2 Class/Backshell | STEP 3 Contact arrangement | STEP 4 Contact gender | STEP 5 Insulation rotation | STEP 6 Mod code (max. 4 codes) |
|---------------------|-----------------------|---------------------------|-------------------------------|--------------------------|-------------------------------|-----------------------------------|
| | CA06COM | E | 20–27 | S | W | B – 02 |

| CA-COM Example | STEP 1 Shell style | STEP 2 Class/Backshell | STEP 3 Contact arrangement | STEP 4 Contact gender | STEP 5 Insulation rotation | STEP 6 Mod code (max. 4 codes) |
|-------------------|-----------------------|---------------------------|-------------------------------|--------------------------|-------------------------------|-----------------------------------|
| | CA06COM | E | 20–27 | S | W | – 01 – DN |

Part number creation receptacle

Follow these steps to design your connector part number.

STEP 1 Select shell style (receptacle)

| Wall Mounting | | Cable connecting | | Box Mounting | |
|---|---|---|--|---|---|
| Bayonet | Threaded | Bayonet | Threaded | Bayonet and Threaded (no backshell) | |
|  |  |  |  |  |  |
| CA00COM-B | CA00COM | CA01COM-B | CA01COM | CA02COM-B | CA20COM |

STEP 2 Choose backshell

Class F
For Flex tube

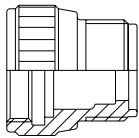

Class PG; ME
Grommet seal with strain relief

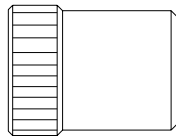

Class E
General duty, strain relief

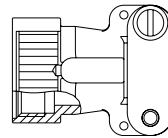

Class E
Environmental, grommet seal, heat shrink boot adapter
Mod. -03; -06 (bayonet),
Mod. DN (treaded)

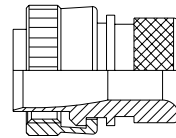

STEP 3 Choose layout

see page 11–14 for layouts

STEP 4 Choose gender

P=pin S=socket

STEP 5 Choose rotation

see page 15 for rotation (omit for normal position)

STEP 6 Choose modification

see page 10 for modifications

Design your part number as per above steps

| CA-COM-B Example | STEP 1 Shell style | STEP 2 Class/Backshell | STEP 3 Contact arrangement | STEP 4 Contact gender | STEP 5 Insulation rotation | STEP 6 Mod code (max. 4 codes) |
|---------------------|-----------------------|---------------------------|-------------------------------|--------------------------|-------------------------------|-----------------------------------|
| | CA00COM | PG | 18-1 | P | X | B - 01 |

| CA-COM Example | STEP 1 Shell style | STEP 2 Class/Backshell | STEP 3 Contact arrangement | STEP 4 Contact gender | STEP 5 Insulation rotation | STEP 6 Mod code (max. 4 codes) |
|-------------------|-----------------------|---------------------------|-------------------------------|--------------------------|-------------------------------|-----------------------------------|
| | CA00COM | ME | 22-23 | S | Y | |

Ordering reference















Part number explanation

CA 06 COM-E 18-1 P W B- XX
 CA 06 COM-E 18-1 P W B- XX

| | |
|--|----------------|
| Series CA – Cannon Designation | |
| Shell type | |
| 00 – Wall mounting receptacle | see page 18–21 |
| 01 – cable connecting plug | see page 22–25 |
| 02 – Box mounting receptacle | see page 26+28 |
| 20 – Box mounting receptacle, rear mounting | see page 27+29 |
| 06 – Plug, straight | see page 30–33 |
| 08 – Plug, 90° | see page 34–36 |
| Class | |
| COM-E – Endbell with cable clamp ¹ | |
| COM-F – Endbell for flex tube | |
| COM-PG – Adapter for PG-termination | |
| COM-ME – Adapter for Metric-termination | |
| COM-L – PCB solder termination | |
| Shell size | |
| 10SL, 12S, 14S, 16, 16S, 18, 20, 22, 24, 28, 32, 36 | |
| Contact arrangement | see page 11–15 |
| Contact type | |
| P – pin | |
| S – socket | |
| Alternate insert position | see page 14 |
| Insulator rotation | |
| Coupling | |
| B – Bayonet coupling (without designation = threaded coupling) | |
| Modification | |
| 01 – Metric crimp contacts | |
| 03 – Adapter for heat shrink boots and metric crimp contacts (bayonet coupling only) | |
| 06 – Adapter for heat shrink boots and solder pot contacts (bayonet coupling only) | |
| 44 – With ending and grommet (individual wire sealing, Class E and F only) | |
| 48 – F endbell with O-Ring | |
| BM29 – Threaded flange holes, shell styles 02, 20 and 00 (threaded coupling only) | |
| DN – Adapter for heat shrink boots (threaded coupling only) | |
| F42 – Less backshell / grommet | |
| F0 – Without contacts (to be ordered separately) | |

¹ except shell style 02/20

CONTACT ARRANGEMENTS

| Figure | No. of contacts | Contact arrangements Contact size | Service rating | Insulator position | | | |
|---|-----------------|---------------------------------------|-------------------------------------|--------------------|-----|-----|-----|
| | | | | W | X | Y | Z |
|  | 3 | 10SL-3 15S | A | - | - | - | - |
|  | 2 | 10SL-4 15S | A | - | - | - | - |
|  | 4 | 12SA-10 15S | A | - | - | - | - |
|  | 3 | 14S-1 15S | A | - | - | - | - |
|  | 4 | 14S-2 15S | Inst. | - | 120 | 240 | - |
|  | 5 | 14S-5 15S | Inst. | - | 110 | - | - |
|  | 6 | 14S-6 15S | Inst. | - | - | - | - |
|  | 3 | 14S-7 15S | A | 90 | 180 | 270 | - |
|  | 7 | 14SA7 15S | Inst. | - | - | - | - |
|  | 7 | 16S-1 15S | A | 80 | - | - | 280 |
|  | 5 | 16S-8 15S | A | - | 170 | 265 | - |
|  | 3 2 1 | 16-7 15 (A, B) 8 (C) | A | 80 | 110 | 250 | 280 |
|  | 4 2 2 | 16-9 15 (B, D) 25 (A, C) | A | 35 | 110 | 250 | 325 |
|  | 3 | 16-10 25 | A | 90 | 180 | 270 | - |
|  | 1 | 16-12 4 | A | 0 | - | - | - |
|  | 10 | 18-1 15 | A (B, C, F, G) Inst. (all other) | 70 | 145 | - | 290 |
|  | 4 | 18-4 15 | D | 35 | 110 | 250 | 325 |











CONTACT ARRANGEMENTS

| Figure | No. of contacts | Contact arrangements Contact size | Service rating | Insulator position | | | |
|---|-----------------|--|---------------------------|--------------------|-----|-----|-----|
| | | | | W | X | Y | Z |
|  | 7 5 2 | 18-9 15 (B, C, E-G) 25 (A, D) | Inst. | 80 | 110 | 250 | 280 |
|  | 4 | 18-10 25 | A | - | 120 | 240 | - |
|  | 5 | 18-11 25 | A | - | 170 | 265 | - |
|  | 4 3 1 | 18-13 25 (B, C) 8 (A) | A | 80 | 110 | 250 | 280 |
|  | 1 | 20-2 0 | D | - | - | - | - |
|  | 4 | 20-4 25 | D | 45 | 110 | 250 | - |
|  | 8 | 20-7 15 | A (C-F) D (A, B, G, H) | 80 | 110 | 250 | 280 |
|  | 6 4 2 | 20-8 15 (B, C, E, F) 8 (A, D) | Inst. | 80 | 110 | 250 | 280 |
|  | 9 | 20A9 25 | D (I) A (all other) | - | 110 | 250 | - |
|  | 19 | 20A48 15 | Inst. | - | 80 | 280 | - |
|  | 7 | 20-15 25 | A | 80 | - | - | 280 |
|  | 9 7 2 | 20-16 15 (A-G) 25 (H, I) | A | 80 | 110 | 250 | 280 |
|  | 3 | 20-19 8 | A | 90 | 180 | 270 | - |
|  | 14 | 20-27 15 | A | 35 | 110 | 250 | 325 |
|  | 17 | 20-29 15 | A | 80 | - | - | 280 |
|  | 11 | 20-33 15 | A | - | - | - | - |
|  | 5 3 2 | 22-12 15 (A, C, D) 8 (B, E) | D | 80 | 110 | 250 | 280 |

CONTACT ARRANGEMENTS

| Figure | No. of contacts | Contact arrangements Contact size | Service rating | Insulator position | | | | Special insulator position | |
|--------|-----------------|---|------------------------|--------------------|-----|-----|-----|----------------------------|--------------------------|
| | | | | W | X | Y | Z | | |
| | 19 | 22-14 15 | A | 80 | – | – | 280 | | |
| | 14 | 22-19 15 | A | 80 | 110 | 250 | 280 | | |
| | 4 | 22-22 8 | A | – | 110 | 250 | – | | |
| | 8 | 22-23 25 | D (H) A (all other) | 35 | – | 250 | – | | |
| | 7 | 24-2 25 | D | 80 | – | – | 280 | | |
| | 16 | 24-7 15 (A-M, O) 25 (P, N) | Inst. | 80 | 110 | 250 | 280 | | |
| | 7 | 24-10 8 | A | 80 | – | – | 280 | | |
| | 9 | 24-11 25 (A-C, G-I) 8 (D, F) | A | 35 | 110 | 250 | 325 | | |
| | 11 | 24-20 15 (A-D, G, L) 25 (E, F) | A | 80 | 110 | 250 | 280 | | |
| | 4 | 24-22 8 | D | 45 | 110 | 250 | – | | |
| | 24 | 24-28 15 | Inst. | 80 | 110 | 250 | 280 | | |
| | 22 | 28-11 15 (A-I, N-X) 25 (J-M) | A | 80 | 110 | 250 | 280 | | |
| | 26 | 28-12 15 | A | 90 | 180 | 270 | – | | |
| | 35 | 28-15 15 | A | 80 | 110 | 250 | 280 | | |
| | 14 | 28-20 15 (K-N) 25 (A-J, P) | A | 80 | 110 | 250 | 280 | | |
| | 37 | 28-21 15 | A | 80 | 110 | 250 | 280 | | |
| | 9 | 28A16 16 4 | Inst. | – | – | – | – | 2 4 9 12 | 260 110 250 280 |

CONTACT ARRANGEMENTS

| Figure | No. of contacts | Contact arrangements Contact size | Service rating | Insulator position | | | |
|---|-------------------------|--|-------------------------------------|--------------------|-----|-----|-----|
| | | | | W | X | Y | Z |
|  | 28 19 9 | 28A63 15 25 | A (e) Inst. (all other) | – | – | – | – |
|  | 5 3 2 | 32-1 12 (A, C, D) 0 (B, E) | E (A) D (all other) | 80 | 110 | 250 | 280 |
|  | 2 | 32-5 0 | D | 35 | 110 | 250 | 325 |
|  | 23 16 2 3 2 | 32-6 15 (A–D, S) 25 (U, V) 8 (P–T) 4 (W, X) | A | 80 | 110 | 250 | 280 |
|  | 35 28 7 | 32-7 15 (A–N, W, Z, a, k) 25 (O–V) | Inst. (A, B, h, i) A (all other) | 80 | 125 | 235 | 280 |
|  | 55 55 | 32A55 15 | A | 80 | 110 | 250 | 280 |
|  | 4 | 32-17 4 | D | 45 | 110 | 250 | – |
|  | 61 41 20 | 32A69 20 15 | Inst. | – | 110 | 250 | – |
|  | 4 | 36-5 0 | A | – | 120 | 240 | – |
|  | 48 | 36-10 15 | A | 80 | 125 | 235 | 280 |

ALTERNATE INSERT POSITION

Indicates location of centerline of key or keyway of shells in fixed normal position. Insert is rotated as shown by arrow and letters.

Tolerances:

Pin insulator 10SL-20: $\pm 2,0^\circ$

Pin insulator 22-36: $\pm 1,5^\circ$

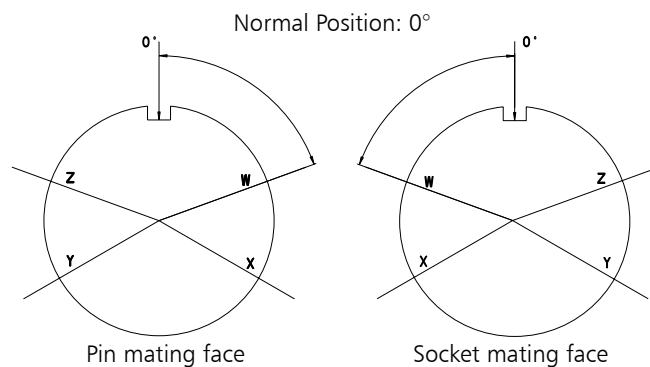

CONTACT ARRANGEMENTS

Contact count per contact arrangement

On pages 11–14 the contact arrangements are shown by shell sizes. The table below gives an overview on the number of contacts, contact size and per contact arrangement.

| Contact Arrangement | No. of Contacts | Contact Size | | | | | | |
|---------------------|-----------------|--------------|-----|----|----|---|---|---|
| | | 10 | 15S | 15 | 25 | 8 | 4 | 0 |
| 16-12 | 1 | | | | | | 1 | |
| 20-2 | 1 | | | | | | | 1 |
| 10SL-4 | 2 | 2 | | | | | | |
| 32-5 | 2 | | | | | | | 2 |
| 10SL-3 | 3 | 3 | | | | | | |
| 14S-1 | 3 | 3 | | | | | | |
| 14S-7 | 3 | 3 | | | | | | |
| 16-7 | 3 | | 2 | | 1 | | | |
| 16-10 | 3 | | | 3 | | | | |
| 20-19 | 3 | | | | | 3 | | |
| 12SA10 | 4 | 4 | | | | | | |
| 14S-2 | 4 | 4 | | | | | | |
| 16-9 | 4 | | 2 | 2 | | | | |
| 18-4 | 4 | | 4 | | | | | |
| 18-10 | 4 | | | 4 | | | | |
| 18-13 | 4 | | | 3 | 1 | | | |
| 20-4 | 4 | | | 4 | | | | |
| 22-22 | 4 | | | | | 4 | | |
| 24-22 | 4 | | | | | 4 | | |
| 32-17 | 4 | | | | | | 4 | |
| 36-5 | 4 | | | | | | | 4 |
| 14S-5 | 5 | 5 | | | | | | |
| 16S-8 | 5 | 5 | | | | | | |
| 18-11 | 5 | | | 5 | | | | |
| 22-12 | 5 | | 3 | | 2 | | | |
| 32-1 | 5 | | | 3 | | | | 2 |
| 14S-6 | 6 | 6 | | | | | | |
| 20-8 | 6 | | 4 | | 2 | | | |
| 14SA7 | 7 | 7 | | | | | | |
| 16S-1 | 7 | 7 | | | | | | |
| 18-9 | 7 | | 5 | 2 | | | | |
| 20-15 | 7 | | | 7 | | | | |
| 24-2 | 7 | | | 7 | | | | |
| 24-10 | 7 | | | | 7 | | | |
| 20-7 | 8 | | | 8 | | | | |
| 22-23 | 8 | | | 8 | | | | |

| Contact Arrangement | No. of Contacts | Contact Size | | | | | | |
|---------------------|-----------------|--------------|-----|----|----|---|---|---|
| | | 10 | 15S | 15 | 25 | 8 | 4 | 0 |
| 20A9 | 9 | | | | | 9 | | |
| 20-16 | 9 | | | 7 | 2 | | | |
| 24-11 | 9 | | | | 6 | 3 | | |
| 28A16 | 9 | | | 5 | | | 4 | |
| 18-1 | 10 | | | 10 | | | | |
| 20-33 | 11 | | | 11 | | | | |
| 24-20 | 11 | | | 9 | 2 | | | |
| 20-27 | 14 | | | 14 | | | | |
| 22-19 | 14 | | | 14 | | | | |
| 28-20 | 14 | | | 4 | 10 | | | |
| 24-7 | 16 | | | 14 | 2 | | | |
| 20-29 | 17 | | | 17 | | | | |
| 20A48 | 19 | | | 19 | | | | |
| 22-14 | 19 | | | 19 | | | | |
| 28-11 | 22 | | | 18 | 4 | | | |
| 32-6 | 23 | | | 16 | 2 | 3 | 2 | |
| 24-28 | 24 | | | 24 | | | | |
| 28-12 | 26 | | | 26 | | | | |
| 28A63 | 28 | | | 19 | 9 | | | |
| 28-15 | 35 | | | 35 | | | | |
| 32-7 | 35 | | | 28 | 7 | | | |
| 28-21 | 37 | | | 37 | | | | |
| 36-10 | 48 | | | 48 | | | | |
| 32A55 | 55 | | | 55 | | | | |
| 32A69 | 61 | 41 | | 20 | | | | |

MOUNTING HOLES

| Shell size | CA-COM Threaded | | | | CA-COM-Bayonet | | | Mounting holes for connectors styles, complete receptacle range |
|------------|-----------------------------|-------------------|--------|------|-----------------------------|-------------------|--------|---|
| | d1 H12 CA00... , CA20... | d1 H12 CA02... | d2 H13 | e | d1 H12 CA00... , CA20... | d1 H12 CA02... | d2 H13 | |
| 10SL | 16,0 | 16,4 | 3,4 | 18,2 | 19,1 | 17,0 | 3,4 | |
| 12S | 19,1 | 16,4 | 3,4 | 20,6 | 22,0 | 17,0 | 3,4 | |
| 14S | 22,3 | 19,7 | 3,4 | 23,0 | 25,5 | 20,0 | 3,4 | |
| 16S/16 | 25,5 | 22,9 | 3,4 | 24,6 | 28,3 | 23,0 | 3,4 | |
| 18 | 28,7 | 26,1 | 3,4 | 27,0 | 31,7 | 26,5 | 3,4 | |
| 20 | 31,8 | 29,5 | 3,4 | 29,4 | 35,0 | 30,0 | 3,4 | |
| 22 | 35,0 | 32,7 | 3,4 | 31,8 | 38,3 | 33,0 | 3,4 | |
| 24 | 38,2 | 36,0 | 3,9 | 34,9 | 41,8 | 36,0 | 3,9 | |
| 28 | 44,5 | 42,0 | 3,9 | 39,7 | 47,6 | 42,0 | 3,9 | |
| 32 | 50,9 | 48,3 | 4,5 | 44,5 | 54,3 | 48,5 | 4,5 | |
| 36 | 57,2 | 53,1 | 4,5 | 49,2 | 60,5 | 55,0 | 4,5 | |

HARNESSING

CA-COM connectors are designed for single wire harnessing, if an individual wire sealing grommet is used. Wires have to conform to wire and insulation diameters with the data given in the following table:

| Contact size | | Crimp/solder contacts | | Insulation Ø | |
|--------------|--------------|-----------------------|---------------------------|--------------|--------------|
| AWG | metric mm | AWG | metric mm ² | AWG | metric mm |
| - | 10 | - | 0,75-1,0 | - | 1,45-2,5 |
| 16S/15S | 16/15 | 16 | 0,75-1,5 | 1,6-2,8 | 1,60-2,8 |
| 12 | 25 | 12 | 2,5 | 2,9-3,5 | 2,9-3,5 |
| - | 60 | - | 6,0 | - | 3,5-4,9 |
| 8 | 100 | 8 | 10,0 | 4,2-5,8 | 5,5-6,5 |
| 4 | 160 | 4 | 16,0 | 6,2-9,0 | 7,1-9,0 |
| 0 | 500 | 0 | 50,0 | 10,5-13,0 | 10,5-13,0 |

WIRE STRIPPING

Either mechanical or hot stripping can be used. Prevent conductors or insulators damage. For solder contacts, conductors have to be pretinned.

Note: Do not twist conductors used with crimp contacts. Do not touch uninsulated conductors before crimping, twisting of conductors and grease or lubricants on the wires cause poor crimp quality.

| Contact size | | Stripping length |
|--------------|--------|------------------|
| AWG | metric | mm |
| - | 10 | 4,0 + 0,4 |
| 16S/15S | 16/15 | 6,0 + 0,5 |
| 12 | 25 | 6,0 + 0,5 |
| 8 | 60/100 | 11,0 + 0,8-0,4 |
| 4 | 160 | 11,0 + 0,8-0,4 |
| 0 | 500 | 13,0 + 0,8-0,4 |

WIRING HINTS

Strip wires carefully. Do not damage conductors and insulation. For solder connections, wires have to be pretinned. Do not twist conductors used in crimp contacts, otherwise no perfect crimp connection will be achieved. Do not touch conductors before crimping. Film of grease or lubricants on the strands will cause poor crimp quality.

For detailed assembly instructions please visit www.ittcannon.com and search for the keyword "CA Bayonet Assembly Instruction".

SEPARATING AND COUPLING DIMENSIONS

PLUG

CA06COM-E
CA06COM-E-B

CA06COM-E-DN
CA06COM-E-B-03/-06

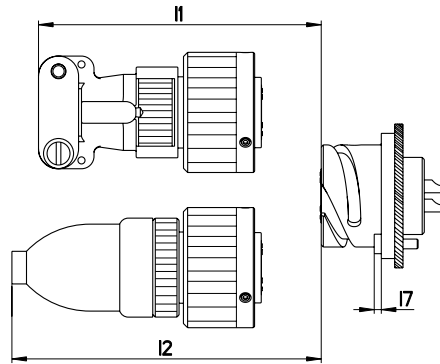

RECEPTACLE

CA02COM-E
CA02COM-E-B

PLUG

CA06COM-F
CA06COM-F-B

CA06COM-PG
CA06COM-PG-B

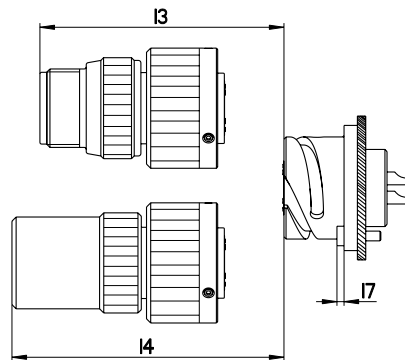

RECEPTACLE

CA02COM-E
CA02COM-E-B

PLUG

CA08COM-E
CA08COM-E-B

CA06COM-E-DN
CA006COM-E-B

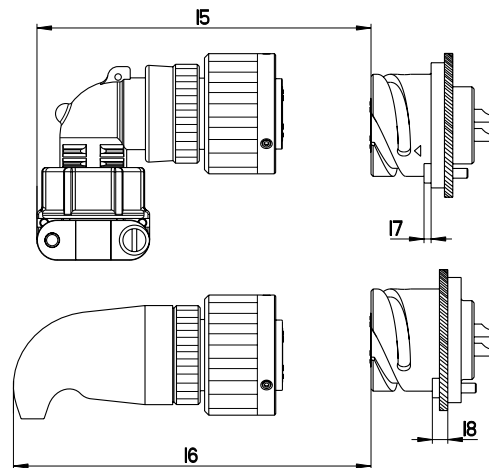

RECEPTACLE

CA02COM-E
CA20COM-E

CA02COM-E-B
CA20COM-E-B

| Shell size | I1 min | I2 min | I3 min | I4 min | I5 min | I6 min | I7 max | I8 max |
|------------|-----------|-----------|-----------|-----------|-----------|-----------|-----------|-----------|
| 10SL | 70 | 70 | 65 | 80 | 70 | 65 | 3,5 | 8,0 |
| 12S | 70 | 75 | 65 | 80 | 75 | 70 | 3,5 | 8,0 |
| 14S | 70 | 75 | 65 | 80 | 75 | 80 | 3,5 | 8,0 |
| 16S | 70 | 90 | 65 | 80 | 80 | 80 | 3,5 | 8,0 |
| 16 | 80 | 100 | 70 | 100 | 90 | 100 | 3,5 | 8,0 |
| 18 | 90 | 100 | 70 | 110 | 95 | 110 | 3,5 | 8,0 |
| 20 | 90 | 100 | 70 | 110 | 95 | 110 | 3,5 | 8,0 |
| 22 | 90 | 100 | 70 | 110 | 95 | 110 | 3,5 | 8,0 |
| 24 | 110 | 120 | 90 | 120 | 105 | 120 | 5,0 | 8,0 |
| 28 | 110 | 120 | 90 | 120 | 105 | 120 | 5,0 | 9,0 |
| 32 | 110 | 180 | 90 | 120 | 115 | 120 | 6,0 | 9,0 |
| 36 | 110 | 190 | 100 | 130 | 120 | 130 | 6,0 | 9,0 |

Dimensions shown in mm | Specifications and dimensions subject to change

WALL MOUNTING RECEPTACLE CLASS PG OR ME

CA00COM-PG-B with bayonet coupling, CA00COM-ME-B

CA00COM-PG/ ME-B is a wall mounting receptacle for usage of PG or Metric glands. It mates with plugs CA06COM-B and CA08COM-B

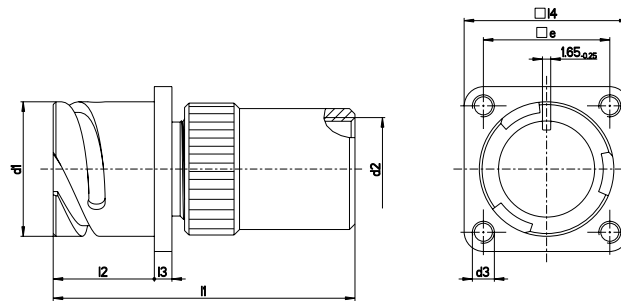

| Part No. (pin insert*) | d1 | d2 | d3 | l1 | l2 | l3 | l4 | e |
|---|-------|---------------------|--------|-----|-------|------|------|------|
| | -0,15 | PG-Thread Metric | Thread | max | +0,4 | +0,2 | ±0,3 | ±0,1 |
| CA00COM-PG10SL**P-B-*** CA00COM-ME10SL**P-B-*** | 18,2 | PG9 M16 × 1,5 | M4 | 56 | 18,20 | 2,8 | 25,4 | 18,2 |
| CA00COM-PG12S**P-B-*** CA00COM-ME12S**P-B-*** | 21,4 | PG9 M16 × 1,5 | M4 | 56 | 18,20 | 3,2 | 28,0 | 20,6 |
| CA00COM-PG14S**P-B-*** CA00COM-ME14S**P-B-*** | 24,6 | PG11 M20 × 1,5 | M4 | 56 | 18,20 | 3,2 | 30,0 | 23,0 |
| CA00COM-PG16S**P-B-*** CA00COM-ME16S**P-B-*** | 27,4 | PG13,5 M20 × 1,5 | M4 | 58 | 18,20 | 3,2 | 32,5 | 24,6 |
| CA00COM-PG16**P-B-*** CA00COM-ME16**P-B-*** | 27,4 | PG13,5 M20 × 1,5 | M4 | 66 | 23,05 | 3,2 | 32,5 | 24,6 |
| CA00COM-PG18**P-B-*** CA00COM-ME18**P-B-*** | 30,8 | PG13,5 M25 × 1,5 | M4 | 73 | 23,05 | 4,0 | 35,0 | 27,0 |
| CA00COM-PG20**P-B-*** CA00COM-ME20**P-B-*** | 34,2 | PG16 M25 × 1,5 | M4 | 74 | 23,05 | 4,0 | 38,0 | 29,4 |
| CA00COM-PG22**P-B-*** CA00COM-ME22**P-B-*** | 37,4 | PG16 M32 × 1,5 | M4 | 77 | 23,05 | 4,0 | 41,0 | 31,8 |
| CA00COM-PG24**P-B-*** CA00COM-ME24**P-B-*** | 40,9 | PG16 M32 × 1,5 | M4 | 77 | 23,05 | 4,0 | 44,5 | 34,9 |
| CA00COM-PG28**P-B-*** CA00COM-ME28**P-B-*** | 46,7 | PG21 M32 × 1,5 | M5 | 78 | 24,05 | 4,0 | 50,8 | 39,7 |
| CA00COM-PG32**P-B-*** CA00COM-ME32**P-B-*** | 53,4 | PG29 M40 × 1,5 | M5 | 78 | 24,05 | 4,0 | 57,0 | 44,5 |
| CA00COM-PG36**P-B-*** CA00COM-ME36**P-B-*** | 59,6 | PG29 M40 × 1,5 | M5 | 89 | 24,05 | 4,0 | 63,5 | 49,2 |

CA00COM-PG with threaded coupling, CA00COM-ME

CA00COM-PG / ME is a wall mounting receptacle for usage of PG or metric glands. It mates with plugs CA06COM and CA08COM

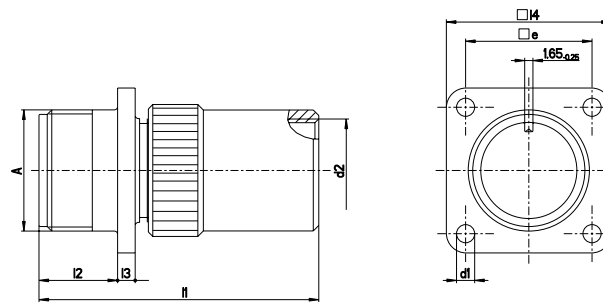

| Part No. (pin insert*) | A | d1 | d2 | l1 | l2 | l3 | l4 | e |
|---|-----------------|-----------|---------------------|-----|------|------|------|------|
| | Thread | +0,2/-0,1 | PG-Thread Metric | max | +0,4 | ±0,3 | ±0,3 | ±0,1 |
| CA00COM-PG10SL**P-*** CA00COM-ME10SL**P-*** | 5/8-24UNEF-2A | 3,1 | PG9 M16 × 1,5 | 52 | 14,2 | 2,8 | 25,4 | 18,2 |
| CA00COM-PG12S**P-*** CA00COM-ME12S**P-*** | 3/4-20UNEF-2A | 3,1 | PG9 M16 × 1,5 | 52 | 14,2 | 3,2 | 28,0 | 20,6 |
| CA00COM-PG14S**P-*** CA00COM-ME14S**P-*** | 7/8-20UNEF-2A | 3,1 | PG11 M20 × 1,5 | 52 | 14,2 | 3,2 | 30,0 | 23,0 |
| CA00COM-PG16S**P-*** CA00COM-ME16S**P-*** | 1-20UNEF-2A | 3,1 | PG13,5 M20 × 1,5 | 54 | 14,2 | 3,2 | 32,5 | 24,6 |
| CA00COM-PG16**P-*** CA00COM-ME16**P-*** | 1-20UNEF-2A | 3,1 | PG13,5 M20 × 1,5 | 64 | 19,0 | 3,2 | 32,5 | 24,6 |
| CA00COM-PG18**P-*** CA00COM-ME18**P-*** | 1-1/8-18UNEF-2A | 3,1 | PG13,5 M25 × 1,5 | 69 | 19,0 | 4,0 | 35,0 | 27,0 |
| CA00COM-PG20**P-*** CA00COM-ME20**P-*** | 1-1/4-18UNEF-2A | 3,1 | PG16 M25 × 1,5 | 70 | 19,0 | 4,0 | 38,0 | 29,4 |
| CA00COM-PG22**P-*** CA00COM-ME22**P-*** | 1-3/8-18UNEF-2A | 3,1 | PG16 M32 × 1,5 | 73 | 19,0 | 4,0 | 41,0 | 31,8 |
| CA00COM-PG24**P-*** CA00COM-ME24**P-*** | 1-1/2-18UNEF-2A | 3,7 | PG16 M32 × 1,5 | 74 | 20,6 | 4,0 | 44,5 | 34,9 |
| CA00COM-PG28**P-*** CA00COM-ME28**P-*** | 1-3/4-18UNEF-2A | 3,7 | PG21 M32 × 1,5 | 74 | 20,6 | 4,0 | 50,8 | 39,7 |
| CA00COM-PG32**P-*** CA00COM-ME32**P-*** | 2-18UNS-2A | 4,4 | PG29 M40 × 1,5 | 76 | 22,2 | 4,0 | 57,0 | 44,5 |
| CA00COM-PG36**P-*** CA00COM-ME36**P-*** | 2-1/4-16UN-2A | 4,4 | PG29 M40 × 1,5 | 87 | 22,2 | 4,0 | 63,5 | 49,2 |

*For socket inserts substitute "S" for "P" **Add contact arrangement number; see pages 11-15 *** Add modification code; see page 10 (bottom)

WALL MOUNTING RECEPTACLE CLASS E

CA00COM-E-B with bayonet coupling

CA00COM-E-B is a wall mounting receptacle with endbell and cable clamp. It mates with plugs CA06COM-B and CA08COM-B

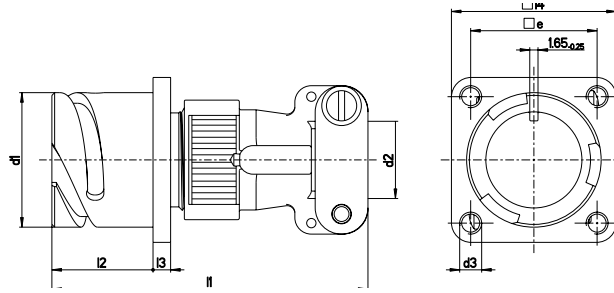

| Part No. (pin insert*) | d1 | d21 | d3 | l1 | l2 | l3 | l4 | e |
|-------------------------|-------|------|--------|-----|-------|-------|-------|-------|
| | -0,15 | | Thread | max | + 0,4 | + 0,2 | ± 0,3 | ± 0,1 |
| CA00COM-E10SL-**P-B-*** | 18,2 | 7,9 | M4 | 57 | 18,20 | 2,8 | 25,4 | 18,2 |
| CA00COM-E12S-**P-B-*** | 21,4 | 7,9 | M4 | 57 | 18,20 | 3,2 | 28,0 | 20,6 |
| CA00COM-E14S-**P-B-*** | 24,6 | 11,1 | M4 | 59 | 18,20 | 3,2 | 30,0 | 23,0 |
| CA00COM-E16S-**P-B-*** | 27,4 | 14,2 | M4 | 60 | 18,20 | 3,2 | 32,5 | 24,6 |
| CA00COM-E16-**P-B-*** | 27,4 | 14,2 | M4 | 68 | 23,05 | 3,2 | 32,5 | 24,6 |
| CA00COM-E18-**P-B-*** | 30,8 | 15,8 | M4 | 72 | 23,05 | 4,0 | 35,0 | 27,0 |
| CA00COM-E20-**P-B-*** | 34,2 | 19,0 | M4 | 72 | 23,05 | 4,0 | 38,0 | 29,4 |
| CA00COM-E22-**P-B-*** | 37,4 | 19,0 | M4 | 72 | 23,05 | 4,0 | 41,0 | 31,8 |
| CA00COM-E24-**P-B-*** | 40,9 | 23,7 | M4 | 78 | 23,05 | 4,0 | 44,5 | 34,9 |
| CA00COM-E28-**P-B-*** | 46,7 | 23,7 | M5 | 79 | 24,05 | 4,0 | 50,8 | 39,7 |
| CA00COM-E32-**P-B-*** | 53,4 | 31,8 | M5 | 78 | 24,05 | 4,0 | 57,0 | 44,5 |
| CA00COM-E36-**P-B-*** | 59,6 | 34,6 | M5 | 78 | 24,05 | 4,0 | 63,5 | 49,2 |

CA00COM-E with threaded coupling

CA00COM-E is a wall mounting receptacle with endbell and cable clamp. It mates with plugs CA06COM and CA08COM

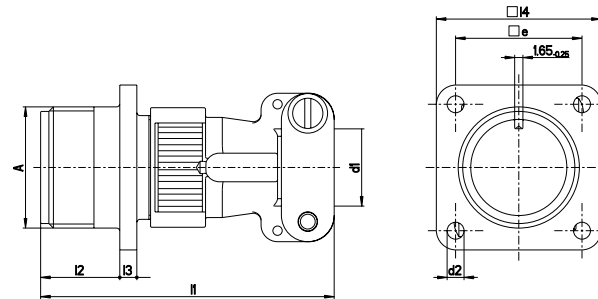

| Part No. (pin insert*) | A | l1 | l2 | l3 | l4 | d1 ¹⁾ | d2 | e |
|------------------------|-----------------|-----|-------|-----|------------|------------------|------------|-------|
| | Thread | max | ± 0,3 | max | + 0,2/-0,1 | + 0,4 | + 0,2/-0,1 | ± 0,3 |
| CA00COM-E10SL-**P-*** | 5/8-24UNEF-2A | 53 | 14,2 | 2,8 | 25,4 | 7,9 | 3,1 | 18,2 |
| CA00COM-E12S-**P-*** | 3/4-20UNEF-2A | 53 | 14,2 | 3,2 | 28,0 | 7,9 | 3,1 | 20,6 |
| CA00COM-E14S-**P-*** | 7/8-20UNEF-2A | 55 | 14,2 | 3,2 | 30,0 | 11,1 | 3,1 | 23,0 |
| CA00COM-E16S-**P-*** | 1-20UNEF-2A | 56 | 14,2 | 3,2 | 32,5 | 14,2 | 3,1 | 24,6 |
| CA00COM-E16-**P-*** | 1-20UNEF-2A | 66 | 19,0 | 3,2 | 32,5 | 14,2 | 3,1 | 24,6 |
| CA00COM-E18-**P-*** | 1-1/8-18UNEF-2A | 68 | 19,0 | 4,0 | 35,0 | 15,8 | 3,1 | 27,0 |
| CA00COM-E20-**P-*** | 1-1/4-18UNEF-2A | 68 | 19,0 | 4,0 | 38,0 | 19,0 | 3,1 | 29,4 |
| CA00COM-E22-**P-*** | 1-3/8-18UNEF-2A | 68 | 19,0 | 4,0 | 41,0 | 19,0 | 3,1 | 31,8 |
| CA00COM-E24-**P-*** | 1-1/2-18UNEF-2A | 76 | 20,6 | 4,0 | 44,5 | 23,7 | 3,7 | 34,9 |
| CA00COM-E28-**P-*** | 1-3/4-18UNEF-2A | 76 | 20,6 | 4,0 | 50,8 | 23,7 | 3,7 | 39,7 |
| CA00COM-E32-**P-*** | 2-18UNS-2A | 76 | 22,2 | 4,0 | 57,0 | 31,8 | 4,4 | 44,5 |
| CA00COM-E36-**P-*** | 2-1/4-16UN-2A | 76 | 22,2 | 4,0 | 63,5 | 34,6 | 4,4 | 49,2 |

* For socket inserts substitute "S" for "P" **Add contact arrangement number; see pages 11-15 *** Add modification code; see page 10 (bottom) ¹⁾max cable dia

WALL MOUNTING RECEPTACLE CLASS F

CA00COM-F-B with bayonet coupling

CA00COM-F-B is a wall mounting receptacle with endbell for flextubes. It mates with plugs CA06COM-B and CA08COM-B

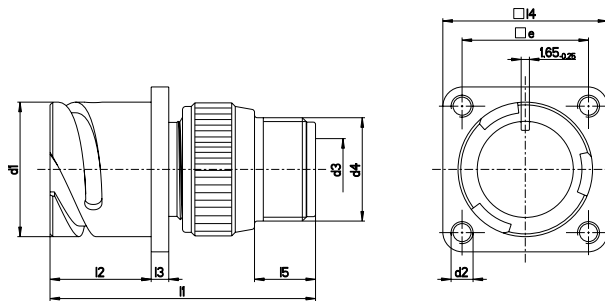

| Part No. (pin insert*) | d1 | d2 | d3 ¹⁾ | d4 | l1 | l2 | l3 | l4 | l5 | e |
|------------------------|-------|--------|------------------|------------------|-----|-------|-------|-------|------|-------|
| | -0,15 | Thread | | Thread | max | + 0,4 | ± 0,2 | ± 0,3 | min | ± 0,1 |
| CA00COM-F10SL**P-B-*** | 18,2 | M4 | 8,2 | 5/8-24UNEF-2A | 52 | 18,20 | 2,8 | 25,4 | 9,5 | 18,2 |
| CA00COM-F12S**P-B-*** | 21,4 | M4 | 8,2 | 5/8-20UNEF-2A | 52 | 18,20 | 3,2 | 28,0 | 9,5 | 20,6 |
| CA00COM-F14S**P-B-*** | 24,6 | M4 | 11,1 | 3/4-20UNEF-2A | 52 | 18,20 | 3,2 | 30,0 | 9,5 | 23,0 |
| CA00COM-F16S**P-B-*** | 27,4 | M4 | 14,3 | 7/8-20UNEF-2A | 59 | 18,20 | 3,2 | 32,5 | 9,5 | 24,6 |
| CA00COM-F16**P-B-*** | 27,4 | M4 | 14,3 | 7/8-20UNEF-2A | 59 | 23,05 | 3,2 | 32,5 | 9,5 | 24,6 |
| CA00COM-F18**P-B-*** | 30,8 | M4 | 16,7 | 1-20UNEF-2A | 63 | 23,05 | 4,0 | 35,0 | 9,5 | 27,0 |
| CA00COM-F20**P-B-*** | 34,2 | M4 | 19,8 | 1-3/16-18UNEF-2A | 63 | 23,05 | 4,0 | 38,0 | 9,5 | 29,4 |
| CA00COM-F22**P-B-*** | 37,4 | M4 | 19,8 | 1-3/16-18UNEF-2A | 66 | 23,05 | 4,0 | 41,0 | 9,5 | 31,8 |
| CA00COM-F24**P-B-*** | 40,9 | M4 | 25,4 | 1-7/16-18UNEF-2A | 69 | 23,05 | 4,0 | 44,5 | 9,5 | 34,9 |
| CA00COM-F28**P-B-*** | 46,7 | M5 | 27,0 | 1-7/16-18UNEF-2A | 70 | 24,05 | 4,0 | 50,8 | 9,5 | 39,7 |
| CA00COM-F32**P-B-*** | 53,4 | M5 | 32,5 | 1-3/4-18UNS-2A | 71 | 24,05 | 4,0 | 57,0 | 11,0 | 44,5 |
| CA00COM-F36**P-B-*** | 59,6 | M5 | 35,7 | 2-18UNS-2A | 73 | 24,05 | 4,0 | 63,5 | 11,8 | 49,2 |

CA00COM-F with threaded coupling

CA00COM-F is a wall mounting receptacle with endbell for flex tubes. It mates with plugs CA06COM and CA08COM

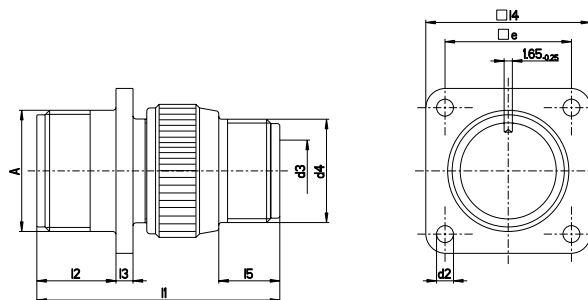

| Part No. (pin insert*) | A | d2 | d3 ¹⁾ | d4 | l1 | l2 | l3 | l4 | l5 | e |
|------------------------|-----------------|------------|------------------|------------------|-----|-------|-------|-------|------|-------|
| | Thread | + 0,2/-0,1 | | Thread | max | + 0,4 | ± 0,3 | ± 0,3 | min | ± 0,1 |
| CA00COM-F10SL**P-*** | 5/8-24UNEF-2A | 3,1 | 8,2 | 5/8-24UNEF-2A | 45 | 14,2 | 2,8 | 25,4 | 9,5 | 18,2 |
| CA00COM-F12S**P-*** | 3/4-20UNEF-2A | 3,1 | 8,2 | 5/8-20UNEF-2A | 45 | 14,2 | 3,2 | 28,0 | 9,5 | 20,6 |
| CA00COM-F14S**P-*** | 7/8-20UNEF-2A | 3,1 | 11,1 | 3/4-20UNEF-2A | 45 | 14,2 | 3,2 | 30,0 | 9,5 | 23,0 |
| CA00COM-F16S**P-*** | 7/8-20UNEF-2A | 3,1 | 14,3 | 7/8-20UNEF-2A | 45 | 14,2 | 3,2 | 32,5 | 9,5 | 24,6 |
| CA00COM-F16**P-*** | 1-20UNEF-2A | 3,1 | 14,3 | 7/8-20UNEF-2A | 54 | 19,0 | 3,2 | 32,5 | 9,5 | 24,6 |
| CA00COM-F18**P-*** | 1-1/8-18UNEF-2A | 3,1 | 16,7 | 1-20UNEF-2A | 54 | 19,0 | 4,0 | 35,0 | 9,5 | 27,0 |
| CA00COM-F20**P-*** | 1-1/4-18UNEF-2A | 3,1 | 19,8 | 1-3/16-18UNEF-2A | 55 | 19,0 | 4,0 | 38,0 | 9,5 | 29,4 |
| CA00COM-F22**P-*** | 1-3/8-18UNEF-2A | 3,1 | 19,8 | 1-3/16-18UNEF-2A | 58 | 19,0 | 4,0 | 41,0 | 9,5 | 31,8 |
| CA00COM-F24**P-*** | 1-1/2-18UNEF-2A | 3,7 | 25,4 | 1-7/16-18UNEF-2A | 59 | 20,6 | 4,0 | 44,5 | 9,5 | 34,9 |
| CA00COM-F28**P-*** | 1-3/4-18UNEF-2A | 3,7 | 27,0 | 1-7/16-18UNEF-2A | 60 | 20,6 | 4,0 | 50,8 | 9,5 | 39,7 |
| CA00COM-F32**P-*** | 2-18UNS-2A | 4,4 | 32,5 | 1-3/4-18UNS-2A | 62 | 22,2 | 4,0 | 57,0 | 11,0 | 44,5 |
| CA00COM-F36**P-*** | 2-1/4-16UN-2A | 4,4 | 35,7 | 2-18UNS-2A | 64 | 22,2 | 4,0 | 63,5 | 11,8 | 49,2 |

* For socket inserts substitute "S" for "P" **Add contact arrangement number; see pages 11-15 *** Add modification code; see page 10 (bottom) ¹⁾max cable dia

WALL MOUNTING RECEPTACLE CLASS E

CA00COM-E-B/-03/-06 with bayonet coupling

CA00COM-E-B/-03/-06 is a wall mounting receptacle (wire sealing) for heat shrink boots. It mates with plugs CA06COM-B and CA08COM-B

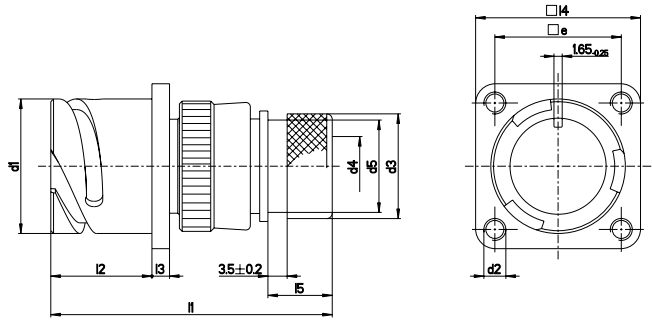

| Part No. (pin insert*) | d1 | d2 | d3 | d4 ¹⁾ | d5 | l1 | l2 | l3 | l4 | l5 | e |
|--------------------------|-------|--------|-------|------------------|------|-----|-------|-------|-------|-------|-------|
| | -0,15 | Thread | ± 0,2 | | max | max | + 0,4 | ± 0,3 | ± 0,3 | ± 0,5 | ± 0,1 |
| CA00COM-E10SL-**-P-B-*** | 18,2 | M4 | 15,5 | 7,7 | 13,3 | 53 | 18,20 | 2,8 | 25,4 | 11,7 | 18,2 |
| CA00COM-E12S-**-P-B-*** | 21,4 | M4 | 15,5 | 7,9 | 13,3 | 53 | 18,20 | 3,2 | 28,0 | 11,7 | 20,6 |
| CA00COM-E14S-**-P-B-*** | 24,6 | M4 | 19,1 | 10,6 | 17,0 | 53 | 18,20 | 3,2 | 30,0 | 11,7 | 23,0 |
| CA00COM-E16S-**-P-B-*** | 27,4 | M4 | 23,9 | 13,5 | 21,9 | 53 | 18,20 | 3,2 | 32,5 | 11,7 | 24,6 |
| CA00COM-E16-**-P-B-*** | 27,4 | M4 | 23,9 | 13,5 | 21,9 | 61 | 23,05 | 3,2 | 32,5 | 11,5 | 24,6 |
| CA00COM-E18-**-P-B-*** | 30,8 | M4 | 23,9 | 14,6 | 21,9 | 62 | 23,05 | 4,0 | 35,0 | 11,5 | 27,0 |
| CA00COM-E20-**-P-B-*** | 34,2 | M4 | 29,6 | 14,6 | 26,2 | 64 | 23,05 | 4,0 | 38,0 | 12,7 | 29,4 |
| CA00COM-E22-**-P-B-*** | 37,4 | M4 | 29,6 | 20,8 | 26,2 | 64 | 23,05 | 4,0 | 41,0 | 12,7 | 31,8 |
| CA00COM-E24-**-P-B-*** | 40,9 | M4 | 37,8 | 24,6 | 34,5 | 64 | 23,05 | 4,0 | 44,5 | 12,7 | 34,9 |
| CA00COM-E28-**-P-B-*** | 46,7 | M5 | 37,8 | 27,0 | 34,5 | 66 | 24,05 | 4,0 | 50,8 | 12,7 | 39,7 |
| CA00COM-E32-**-P-B-*** | 53,4 | M5 | 47,8 | 33,3 | 43,6 | 69 | 24,05 | 4,0 | 57,0 | 15,2 | 44,5 |
| CA00COM-E36-**-P-B-*** | 59,6 | M5 | 47,8 | 38,5 | 43,6 | 70 | 24,05 | 4,0 | 63,5 | 15,2 | 49,2 |

CA00COM-E-DN with threaded coupling

CA00COM-E-DN is a wall mounting receptacle with endbell (wire sealing) for heat shrink boots. It mates with plugs CA06COM and CA08COM

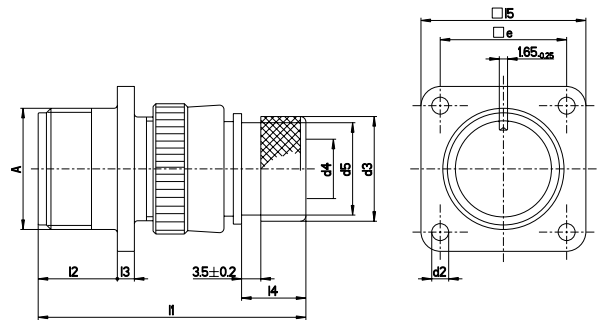

| Part No. (pin insert*) | A | d2 | d3 | d4 ¹⁾ | d5 | l1 | l2 | l3 | l4 | l5 | e |
|------------------------|-----------------|------------|-------|------------------|------|------|-------|-------|-------|-------|-------|
| | Thread | + 0,2/-0,1 | ± 0,2 | | max | max | + 0,4 | ± 0,3 | ± 0,5 | ± 0,3 | ± 0,1 |
| CA00COM-E10SL-**-P-DN | 5/8-24UNEF-2A | 3,1 | 15,5 | 7,7 | 13,3 | 49,0 | 14,2 | 2,8 | 11,7 | 25,4 | 18,2 |
| CA00COM-E12S-**-P-DN | 3/4-20UNEF-2A | 3,1 | 15,5 | 7,9 | 13,3 | 49,0 | 14,2 | 3,2 | 11,7 | 28,0 | 20,6 |
| CA00COM-E14S-**-P-DN | 7/8-20UNEF-2A | 3,1 | 19,1 | 10,6 | 17,0 | 49,0 | 14,2 | 3,2 | 11,7 | 30,0 | 23,0 |
| CA00COM-E16S-**-P-DN | 1-20UNEF-2A | 3,1 | 23,9 | 13,5 | 21,9 | 49,0 | 14,2 | 3,2 | 11,7 | 32,5 | 24,6 |
| CA00COM-E16-**-P-DN | 1-20UNEF-2A | 3,1 | 23,9 | 13,5 | 21,9 | 58,0 | 19,0 | 3,2 | 11,5 | 32,5 | 24,6 |
| CA00COM-E18-**-P-DN | 1-1/8-18UNEF-2A | 3,1 | 23,9 | 14,6 | 21,9 | 58,0 | 19,0 | 4,0 | 11,5 | 35,0 | 27,0 |
| CA00COM-E20-**-P-DN | 1-1/4-18UNEF-2A | 3,1 | 23,9 | 14,6 | 26,2 | 60,0 | 19,0 | 4,0 | 12,7 | 35,0 | 27,0 |
| CA00COM-E22-**-P-DN | 1-3/8-18UNEF-2A | 3,1 | 29,6 | 20,8 | 26,2 | 60,0 | 19,0 | 4,0 | 12,7 | 41,0 | 31,8 |
| CA00COM-E24-**-P-DN | 1-1/2-18UNEF-2A | 3,7 | 37,8 | 24,6 | 34,5 | 63,0 | 20,6 | 4,0 | 12,7 | 44,5 | 34,9 |
| CA00COM-E28-**-P-DN | 1-3/4-18UNEF-2A | 3,7 | 37,8 | 27,0 | 34,5 | 63,0 | 20,6 | 4,0 | 12,7 | 50,8 | 39,7 |
| CA00COM-E32-**-P-DN | 2-18UNS-2A | 4,4 | 47,8 | 33,3 | 43,6 | 67,0 | 22,2 | 4,0 | 15,2 | 57,0 | 44,5 |
| CA00COM-E36-**-P-DN | 2-1/4-16UN-2A | 4,4 | 47,8 | 38,5 | 43,6 | 68,0 | 22,2 | 4,0 | 15,2 | 63,5 | 49,2 |

*For socket inserts substitute "S" for "P" **Add contact arrangement number; see pages 11–15 ***-03: with metric crimp contacts/-06: with solder pot contacts ¹⁾max cable dia

CABLE CONNECTING PLUG CLASS PG OR ME

CA01COM-PG-B with bayonet coupling, CA01COM-ME-B

CA01COM-PG/ME-B is a cable connecting plug for usage of PG or metric glands. It mates with plugs CA06COM-B and CA08COM-B

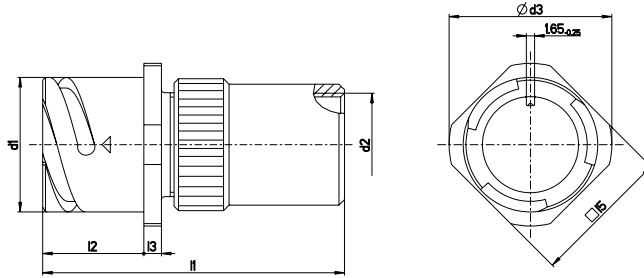

| Part No. PG (pin insert*) | Part No. ME (pin insert*) | d1 -0,15 | d2 | | d3 max | l1 max | l2 +0,4 | l3 +0,2 | l5 ±0,2 |
|---------------------------|---------------------------|-------------|-----------|-----------|-----------|-----------|------------|------------|------------|
| | | | PG-Thread | Metric | | | | | |
| CA01COM-PG10SL-**P-B-*** | CA01COM-ME10SL-**P-B-*** | 18,2 | PG9 | M16 × 1,5 | 25,2 | 56 | 18,2 | 2,8 | 20,6 |
| CA01COM-PG12S-**P-B-*** | CA01COM-ME12S-**P-B-*** | 21,4 | PG9 | M16 × 1,5 | 27,8 | 56 | 18,20 | 3,2 | 23,8 |
| CA01COM-PG14S-**P-B-*** | CA01COM-ME14S-**P-B-*** | 24,6 | PG11 | M20 × 1,5 | 29,8 | 56 | 18,20 | 3,2 | 25,4 |
| CA01COM-PG16S-**P-B-*** | CA01COM-ME16S-**P-B-*** | 27,4 | PG13,5 | M20 × 1,5 | 32,3 | 58 | 18,20 | 3,2 | 28,6 |
| CA01COM-PG16-**P-B-*** | CA01COM-ME16-**P-B-*** | 27,4 | PG13,5 | M20 × 1,5 | 32,3 | 66 | 23,05 | 3,2 | 28,6 |
| CA01COM-PG18-**P-B-*** | CA01COM-ME18-**P-B-*** | 30,8 | PG13,5 | M25 × 1,5 | 34,8 | 73 | 23,05 | 4,0 | 31,7 |
| CA01COM-PG20-**P-B-*** | CA01COM-ME20-**P-B-*** | 34,2 | PG16 | M25 × 1,5 | 37,8 | 74 | 23,05 | 4,0 | 34,9 |
| CA01COM-PG22-**P-B-*** | CA01COM-ME22-**P-B-*** | 37,4 | PG16 | M32 × 1,5 | 41,1 | 77 | 23,05 | 4,0 | 38,1 |
| CA01COM-PG24-**P-B-*** | CA01COM-ME24-**P-B-*** | 40,9 | PG16 | M32 × 1,5 | 44,6 | 77 | 23,05 | 4,0 | 41,3 |
| CA01COM-PG28-**P-B-*** | CA01COM-ME28-**P-B-*** | 46,7 | PG21 | M32 × 1,5 | 50,9 | 78 | 24,05 | 4,0 | 47,6 |
| CA01COM-PG32-**P-B-*** | CA01COM-ME32-**P-B-*** | 53,4 | PG29 | M40 × 1,5 | 57,1 | 78 | 24,05 | 4,0 | 54,0 |
| CA01COM-PG36-**P-B-*** | CA01COM-ME36-**P-B-*** | 59,6 | PG29 | M40 × 1,5 | 63,6 | 89 | 24,05 | 4,0 | 60,6 |

CA01COM-PG with threaded coupling

CA01COM-PG/ME is a cable connecting plug for usage of PG or metric glands. It mates with plugs CA06COM and CA08COM

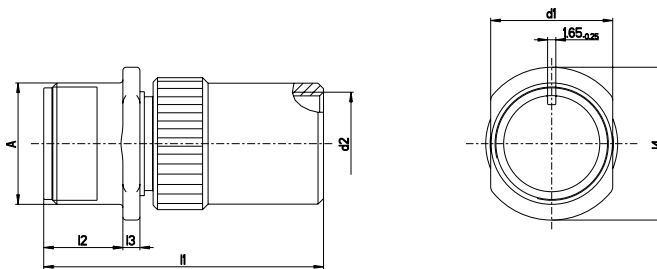

| Part No. PG (pin insert*) | Part No. ME (pin insert*) | A Thread | d1 max | d2 | | l1 max | l2 +0,4 | l3 ±0,3 | l4 max |
|---------------------------|---------------------------|-----------------|-----------|-----------|-----------|-----------|------------|------------|-----------|
| | | | | PG-Thread | Metric | | | | |
| CA01COM-PG10SL-**P-*** | CA01COM-ME10SL-**P-*** | 5/8-24UNEF-2A | 16,2 | PG9 | M16 × 1,5 | 52 | 14,2 | 2,8 | 21,8 |
| CA01COM-PG12S-**P-*** | CA01COM-ME12S-**P-*** | 3/4-20UNEF-2A | 19,4 | PG9 | M16 × 1,5 | 52 | 14,2 | 3,2 | 25,0 |
| CA01COM-PG14S-**P-*** | CA01COM-ME14S-**P-*** | 7/8-20UNEF-2A | 22,5 | PG11 | M20 × 1,5 | 52 | 14,2 | 3,2 | 28,2 |
| CA01COM-PG16S-**P-*** | CA01COM-ME16S-**P-*** | 1-20UNEF-2A | 25,7 | PG13,5 | M20 × 1,5 | 54 | 14,2 | 3,2 | 31,4 |
| CA01COM-PG16-**P-*** | CA01COM-ME16-**P-*** | 1-20UNEF-2A | 25,7 | PG13,5 | M20 × 1,5 | 64 | 19,0 | 3,2 | 31,4 |
| CA01COM-PG18-**P-*** | CA01COM-ME18-**P-*** | 1-1/8-18UNEF-2A | 28,9 | PG13,5 | M25 × 1,5 | 69 | 19,0 | 4,0 | 34,5 |
| CA01COM-PG20-**P-*** | CA01COM-ME20-**P-*** | 1-1/4-18UNEF-2A | 32,1 | PG16 | M25 × 1,5 | 70 | 19,0 | 4,0 | 37,3 |
| CA01COM-PG22-**P-*** | CA01COM-ME22-**P-*** | 1-3/8-18UNEF-2A | 35,2 | PG16 | M32 × 1,5 | 73 | 19,0 | 4,0 | 40,9 |
| CA01COM-PG24-**P-*** | CA01COM-ME24-**P-*** | 1-1/2-18UNEF-2A | 38,4 | PG16 | M32 × 1,5 | 74 | 20,6 | 4,0 | 43,8 |
| CA01COM-PG28-**P-*** | CA01COM-ME28-**P-*** | 1-3/4-18UNEF-2A | 44,8 | PG21 | M32 × 1,5 | 74 | 20,6 | 4,0 | 50,4 |
| CA01COM-PG32-**P-*** | CA01COM-ME32-**P-*** | 2-18UNS-2A | 51,1 | PG29 | M40 × 1,5 | 76 | 22,2 | 4,0 | 56,8 |
| CA01COM-PG36-**P-*** | CA01COM-ME36-**P-*** | 2-1/4-16UN-2A | 57,5 | PG29 | M40 × 1,5 | 87 | 22,2 | 4,0 | 63,1 |

*For socket inserts substitute "S" for "P" **Add contact arrangement number; see pages 11–15 ***Add modification code; see page 10 (bottom)

CABLE CONNECTING PLUG CLASS E

CA01COM-E-B with bayonet coupling

CA01COM-E-B is a cable connecting plug with endbell and cable clamp. It mates with plugs CA06COM-B and CA08COM-B

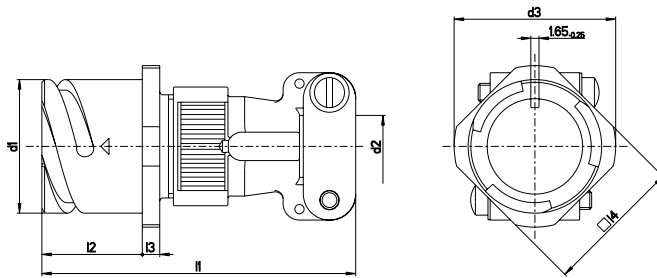

| Part No. (pin insert) | d1 | d2 ¹⁾ | d3 | l1 | l2 | l3 | l4 |
|-------------------------|-------|------------------|------|-----|-------|-------|-------|
| | -0,15 | | max | max | + 0,4 | ± 0,2 | ± 0,2 |
| CA01COM-E10SL-**P-B-*** | 18,2 | 7,9 | 25,2 | 57 | 18,20 | 2,8 | 20,6 |
| CA01COM-E12S-**P-B-*** | 21,4 | 7,9 | 27,8 | 57 | 18,20 | 3,2 | 23,8 |
| CA01COM-E14S-**P-B-*** | 24,6 | 11,1 | 29,8 | 59 | 18,20 | 3,2 | 25,4 |
| CA01COM-E16S-**P-B-*** | 27,4 | 14,2 | 32,3 | 60 | 18,20 | 3,2 | 28,6 |
| CA01COM-E16-**P-B-*** | 27,4 | 14,2 | 32,3 | 68 | 23,05 | 3,2 | 28,6 |
| CA01COM-E18-**P-B-*** | 30,8 | 15,8 | 34,8 | 72 | 23,05 | 4,0 | 31,7 |
| CA01COM-E20-**P-B-*** | 34,2 | 19,0 | 37,8 | 72 | 23,05 | 4,0 | 34,9 |
| CA01COM-E22-**P-B-*** | 37,4 | 19,0 | 41,1 | 72 | 23,05 | 4,0 | 38,1 |
| CA01COM-E24-**P-B-*** | 40,9 | 23,7 | 44,6 | 78 | 23,05 | 4,0 | 41,3 |
| CA01COM-E28-**P-B-*** | 46,7 | 23,7 | 50,9 | 79 | 24,05 | 4,0 | 47,6 |
| CA01COM-E32-**P-B-*** | 53,4 | 31,8 | 57,1 | 78 | 24,05 | 4,0 | 54,0 |
| CA01COM-E36-**P-B-*** | 59,6 | 34,6 | 63,6 | 78 | 24,05 | 4,0 | 60,6 |

CA01COM-E with threaded coupling

CA01COM-E is a cable connecting plug with endbell and cable clamp. It mates with plugs CA06COM and CA08COM

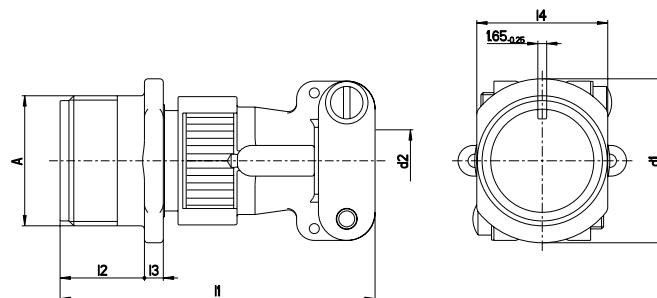

| Part No. (pin insert) | A | d1 | d2 ¹⁾ | l1 | l2 | l3 | l4 |
|-----------------------|-----------------|------|------------------|-----|-------|-------|------|
| | Thread | max | | max | + 0,4 | ± 0,3 | max |
| CA01COM-E10SL-**P-*** | 5/8-24UNEF-2A | 21,8 | 7,9 | 53 | 14,2 | 2,8 | 16,2 |
| CA01COM-E12S-**P-*** | 3/4-20UNEF-2A | 25,0 | 7,9 | 53 | 14,2 | 3,2 | 19,4 |
| CA01COM-E14S-**P-*** | 7/8-20UNEF-2A | 28,2 | 11,1 | 55 | 14,2 | 3,2 | 22,5 |
| CA01COM-E16S-**P-*** | 1-20UNEF-2A | 31,4 | 14,2 | 56 | 14,2 | 3,2 | 25,7 |
| CA01COM-E16-**P-*** | 1-20UNEF-2A | 31,4 | 14,2 | 66 | 19,0 | 3,2 | 25,7 |
| CA01COM-E18-**P-*** | 1-1/8-18UNEF-2A | 34,5 | 15,8 | 68 | 19,0 | 4,0 | 28,9 |
| CA01COM-E20-**P-*** | 1-1/4-18UNEF-2A | 37,3 | 19,0 | 68 | 19,0 | 4,0 | 32,1 |
| CA01COM-E22-**P-*** | 1-3/8-18UNEF-2A | 40,9 | 19,0 | 68 | 19,0 | 4,0 | 35,2 |
| CA01COM-E24-**P-*** | 1-1/2-18UNEF-2A | 43,8 | 23,7 | 76 | 20,6 | 4,0 | 38,4 |
| CA01COM-E28-**P-*** | 1-3/4-18UNEF-2A | 50,4 | 23,7 | 76 | 20,6 | 4,0 | 44,8 |
| CA01COM-E32-**P-*** | 2-18UNS-2A | 56,8 | 31,8 | 76 | 22,2 | 4,0 | 51,1 |
| CA01COM-E36-**P-*** | 2-1/4-16UN-2A | 63,1 | 34,6 | 76 | 22,2 | 4,0 | 57,5 |

*For socket inserts substitute "S" for "P" **Add contact arrangement number; see pages 11–15 *** Add modification code; see page 10 (bottom) ¹⁾max cable dia

CABLE CONNECTING PLUG CLASS E

CA01COM-E-B/-03/-06 with bayonet coupling

CA01COM-E-B/-03/-06 is a cable connecting plug with endbell (wire sealing) for heat shrink boots. It mates with plugs CA06COM-B and CA08COM-B

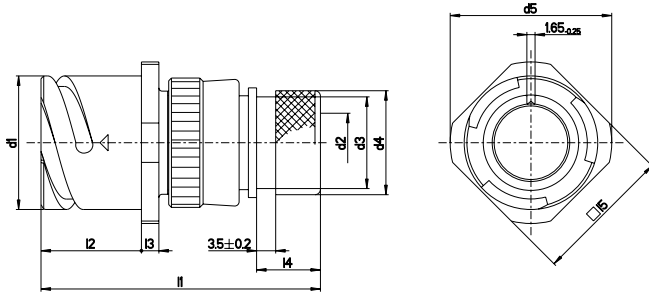

| Part No. (pin insert*) | d1 | d2 ¹⁾ | d3 | d4 | d5 | l1 | l2 | l3 | l4 | l5 |
|--------------------------|-------|------------------|------|-------|------|-----|-------|-------|-------|-------|
| | -0,15 | max | max | ± 0,2 | max | max | + 0,4 | ± 0,3 | ± 0,5 | ± 0,2 |
| CA01COM-E10SL-**-P-B-*** | 18,2 | 7,7 | 13,3 | 15,5 | 25,2 | 53 | 18,20 | 2,8 | 11,7 | 20,6 |
| CA01COM-E12S-**-P-B-*** | 21,4 | 7,9 | 13,3 | 15,5 | 27,8 | 53 | 18,20 | 3,2 | 11,7 | 23,8 |
| CA01COM-E14S-**-P-B-*** | 24,6 | 10,6 | 17,0 | 19,1 | 29,8 | 53 | 18,20 | 3,2 | 11,7 | 25,4 |
| CA01COM-E16S-**-P-B-*** | 27,4 | 13,5 | 21,9 | 23,9 | 32,3 | 53 | 18,20 | 3,2 | 11,7 | 28,6 |
| CA01COM-E16-**-P-B-*** | 27,4 | 13,5 | 21,9 | 23,9 | 32,3 | 61 | 23,05 | 3,2 | 11,5 | 28,6 |
| CA01COM-E18-**-P-B-*** | 30,8 | 14,6 | 21,9 | 23,9 | 34,8 | 62 | 23,05 | 4,0 | 11,5 | 31,7 |
| CA01COM-E20-**-P-B-*** | 34,2 | 18,7 | 26,2 | 29,6 | 37,8 | 64 | 23,05 | 4,0 | 12,7 | 34,9 |
| CA01COM-E22-**-P-B-*** | 37,4 | 20,8 | 26,2 | 29,6 | 41,1 | 64 | 23,05 | 4,0 | 12,7 | 38,1 |
| CA01COM-E24-**-P-B-*** | 40,9 | 24,6 | 34,5 | 37,8 | 44,6 | 64 | 23,05 | 4,0 | 12,7 | 41,3 |
| CA01COM-E28-**-P-B-*** | 46,7 | 27,0 | 34,5 | 37,8 | 50,9 | 66 | 24,05 | 4,0 | 12,7 | 47,6 |
| CA01COM-E32-**-P-B-*** | 53,4 | 33,3 | 43,6 | 47,8 | 57,1 | 69 | 24,05 | 4,0 | 15,2 | 54,0 |
| CA01COM-E36-**-P-B-*** | 59,6 | 38,5 | 43,6 | 47,8 | 63,6 | 70 | 24,05 | 4,0 | 15,2 | 60,6 |

CA01COM-E-DN with threaded coupling

CA01COM-E-DN is a cable connecting plug with endbell (wire sealing) for heat shrink boots. It mates with plugs CA06COM and CA08COM

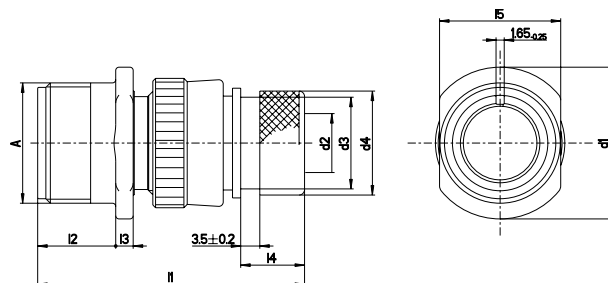

| Part No. (pin insert*) | A | d1 | d2 ¹⁾ | d3 | d4 | l1 | l2 | l3 | l4 | l5 |
|------------------------|-----------------|------|------------------|-------|-------|------|-------|-------|------|-------|
| | Thread | max | max | ± 0,5 | ± 0,2 | max | ± 0,3 | ± 0,3 | max | ± 0,2 |
| CA01COM-E10SL-**-P-DN | 5/8-24UNEF-2A | 21,8 | 7,7 | 15,5 | 15,5 | 49,0 | 14,2 | 2,8 | 11,7 | 16,2 |
| CA01COM-E12S-**-P-DN | 3/4-20UNEF-2A | 25,0 | 7,9 | 15,5 | 15,5 | 49,0 | 14,2 | 3,2 | 11,7 | 19,4 |
| CA01COM-E14S-**-P-DN | 7/8-20UNEF-2A | 28,2 | 10,6 | 19,1 | 19,1 | 49,0 | 14,2 | 3,2 | 11,7 | 22,5 |
| CA01COM-E16S-**-P-DN | 1-20UNEF-2A | 31,4 | 13,5 | 23,9 | 23,9 | 49,0 | 14,1 | 3,2 | 11,7 | 25,7 |
| CA01COM-E16-**-P-DN | 1-20UNEF-2A | 31,4 | 13,5 | 23,9 | 23,9 | 58,0 | 19,0 | 3,2 | 11,5 | 25,7 |
| CA01COM-E18-**-P-DN | 1-1/8-18UNEF-2A | 34,5 | 14,6 | 23,9 | 23,9 | 58,0 | 19,0 | 4,0 | 11,5 | 28,9 |
| CA01COM-E20-**-P-DN | 1-1/4-18UNEF-2A | 37,3 | 18,7 | 29,6 | 29,6 | 60,0 | 19,0 | 4,0 | 12,7 | 32,1 |
| CA01COM-E22-**-P-DN | 1-3/8-18UNEF-2A | 40,9 | 20,8 | 29,6 | 29,6 | 60,0 | 19,0 | 4,0 | 12,7 | 35,2 |
| CA01COM-E24-**-P-DN | 1-1/2-18UNEF-2A | 43,8 | 24,6 | 37,8 | 37,8 | 63,0 | 20,6 | 4,0 | 12,7 | 38,4 |
| CA01COM-E28-**-P-DN | 1-3/4-18UNEF-2A | 50,4 | 27,0 | 37,8 | 37,8 | 63,0 | 20,6 | 4,0 | 12,7 | 44,8 |
| CA01COM-E32-**-P-DN | 2-18UNS-2A | 56,8 | 33,3 | 47,8 | 47,8 | 67,0 | 22,2 | 4,0 | 15,2 | 51,1 |
| CA01COM-E36-**-P-DN | 2-1/4-16UN-2A | 63,1 | 38,5 | 47,8 | 47,8 | 68,0 | 22,2 | 4,0 | 15,2 | 57,5 |

* For socket inserts substitute "S" for "P" ** Add contact arrangement number; see pages 11–15 *** -03: with metric crimp contacts / -06: with solder pot contacts ¹⁾ max cable dia

CABLE CONNECTING PLUG CLASS F

CA01COM-F-B with bayonet coupling

CA01COM-F-B is a cable connecting plug for flex tube. It mates with plugs CA06COM-B and CA08COM-B

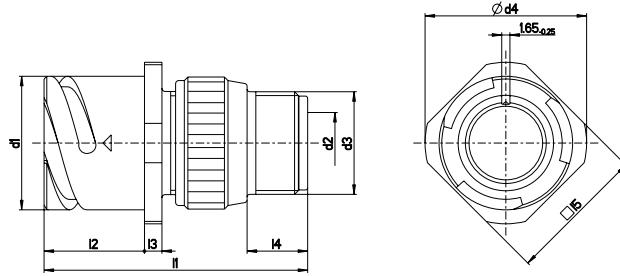

| Part No. (pin insert*) | d1 | d2 ¹⁾ | d3 | d4 | l1 | l2 | l3 | l4 | l5 |
|-------------------------|-------|------------------|------------------|------|-----|-------|-------|------|-------|
| | -0,15 | | Thread | max | max | + 0,4 | ± 0,2 | min | ± 0,2 |
| CA01COM-F10SL-**P-B-*** | 18,2 | 8,2 | 5/8-24UNEF-2A | 25,2 | 50 | 18,20 | 2,8 | 9,5 | 20,6 |
| CA01COM-F12S-**P-B-*** | 18,2 | 8,2 | 5/8-20UNEF-2A | 27,8 | 50 | 18,20 | 3,2 | 9,5 | 23,8 |
| CA01COM-F14S-**P-B-*** | 24,6 | 11,1 | 3/4-20UNEF-2A | 29,8 | 50 | 18,20 | 3,2 | 9,5 | 25,4 |
| CA01COM-F16S-**P-B-*** | 27,4 | 14,3 | 7/8-20UNEF-2A | 32,3 | 50 | 18,20 | 3,2 | 9,5 | 28,6 |
| CA01COM-F16-**P-B-*** | 27,4 | 14,3 | 7/8-20UNEF-2A | 32,3 | 57 | 23,05 | 3,2 | 9,5 | 28,6 |
| CA01COM-F18-**P-B-*** | 30,8 | 16,7 | 1-20UNEF-2A | 34,8 | 59 | 23,05 | 4,0 | 9,5 | 31,7 |
| CA01COM-F20-**P-B-*** | 34,2 | 19,8 | 1-3/16-18UNEF-2A | 37,8 | 59 | 23,05 | 4,0 | 9,5 | 34,9 |
| CA01COM-F22-**P-B-*** | 37,4 | 19,8 | 1-3/16-18UNEF-2A | 41,1 | 62 | 23,05 | 4,0 | 9,5 | 38,1 |
| CA01COM-F24-**P-B-*** | 40,9 | 25,4 | 1-7/16-18UNEF-2A | 44,6 | 62 | 23,05 | 4,0 | 9,5 | 41,3 |
| CA01COM-F28-**P-B-*** | 46,7 | 27,0 | 1-7/16-18UNEF-2A | 50,9 | 64 | 24,05 | 4,0 | 9,5 | 47,6 |
| CA01COM-F32-**P-B-*** | 53,4 | 32,5 | 1-3/4-18UNS-2A | 57,1 | 64 | 24,05 | 4,0 | 11,0 | 54,0 |
| CA01COM-F36-**P-B-*** | 59,6 | 35,7 | 2-18UNS-2A | 63,6 | 66 | 24,05 | 4,0 | 11,8 | 60,6 |

CA01COM-F with threaded coupling

CA01COM-F is a cable connecting plug for flex tube. It mates with plugs CA06COM and CA08COM

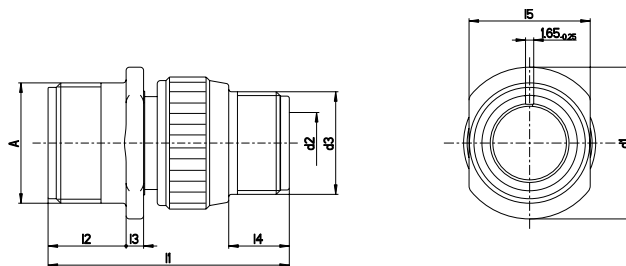

| Part No. (pin insert*) | A | d1 | d2 ¹⁾ | d3 | l1 | l2 | l3 | l4 | l5 |
|------------------------|-----------------|------|------------------|------------------|-----|-------|-------|------|-------|
| | Thread | max | | Thread | max | + 0,4 | ± 0,3 | min | ± 0,2 |
| CA01COM-F10SL-**P-*** | 5/8-24UNEF-2A | 21,8 | 8,2 | 5/8-24UNEF-2A | 45 | 14,2 | 2,8 | 9,5 | 16,2 |
| CA01COM-F12S-**P-*** | 3/4-20UNEF-2A | 25,0 | 8,2 | 5/8-20UNEF-2A | 45 | 14,2 | 3,2 | 9,5 | 19,4 |
| CA01COM-F14S-**P-*** | 7/8-20UNEF-2A | 28,2 | 11,1 | 3/4-20UNEF-2A | 45 | 14,2 | 3,2 | 9,5 | 22,5 |
| CA01COM-F16S-**P-*** | 1-20UNEF-2A | 31,4 | 14,3 | 7/8-20UNEF-2A | 45 | 14,2 | 3,2 | 9,5 | 25,7 |
| CA01COM-F16-**P-*** | 1-20UNEF-2A | 31,4 | 14,3 | 7/8-20UNEF-2A | 54 | 14,2 | 3,2 | 9,5 | 25,7 |
| CA01COM-F18-**P-*** | 1-1/8-18UNEF-2A | 34,5 | 16,7 | 1-20UNEF-2A | 54 | 19,0 | 4,0 | 9,5 | 28,9 |
| CA01COM-F20-**P-*** | 1-1/4-18UNEF-2A | 37,3 | 19,8 | 1-3/16-18UNEF-2A | 55 | 19,0 | 4,0 | 9,5 | 32,1 |
| CA01COM-F22-**P-*** | 1-3/8-18UNEF-2A | 40,9 | 19,8 | 1-3/16-18UNEF-2A | 58 | 20,6 | 4,0 | 9,5 | 35,2 |
| CA01COM-F24-**P-*** | 1-1/2-18UNEF-2A | 43,8 | 25,4 | 1-7/16-18UNEF-2A | 59 | 20,6 | 4,0 | 9,5 | 38,4 |
| CA01COM-F28-**P-*** | 1-3/4-18UNEF-2A | 50,4 | 27,0 | 1-7/16-18UNEF-2A | 60 | 20,6 | 4,0 | 9,5 | 44,8 |
| CA01COM-F32-**P-*** | 2-18UNS-2A | 56,8 | 32,5 | 1-3/4-18UNS-2A | 62 | 22,2 | 4,0 | 11,0 | 51,1 |
| CA01COM-F36-**P-*** | 2-1/4-16UN-2A | 63,1 | 35,7 | 2-18UNS-2A | 64 | 22,2 | 4,0 | 11,8 | 57,5 |

*For socket inserts substitute "S" for "P" **Add contact arrangement number; see pages 11–15 *** Add modification code; see page 10 (bottom) ¹⁾max cable dia

BOX MOUNTING RECEPTACLE CLASS E

CA02COM-E-B with bayonet coupling

CA02COM-E-B is a box mounting receptacle for front panel mounting. It mates with plugs CA06COM-B and CA08COM-B

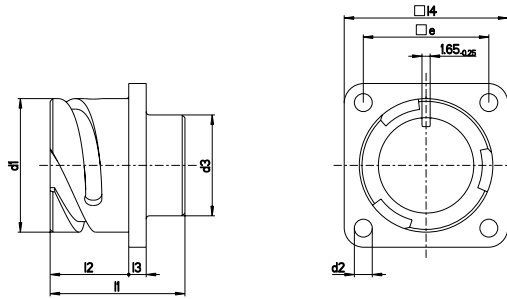

| Part No. (pin insert*) | d1 | d2 | d3 | l1 | l2 | l3 | l4 | e |
|--------------------------|-------|-----|------|-------|-------|-------|-------|-------|
| | -0,15 | H13 | max. | ± 0,3 | + 0,4 | ± 0,2 | ± 0,3 | ± 0,1 |
| CA02COM-E10SL-**-P-B-*** | 18,2 | 3.1 | 16,2 | 24,7 | 14,2 | 2,8 | 25,4 | 18,2 |
| CA02COM-E12S-**-P-B-*** | 21,4 | 3.1 | 16,2 | 24,7 | 14,2 | 3,2 | 28,0 | 20,6 |
| CA02COM-E14S-**-P-B-*** | 24,6 | 3.1 | 19,2 | 24,7 | 14,2 | 3,2 | 30,0 | 23,0 |
| CA02COM-E16S-**-P-B-*** | 27,4 | 3.1 | 22,4 | 24,7 | 14,2 | 3,2 | 32,5 | 24,6 |
| CA02COM-E16-**-P-B-*** | 27,4 | 3.1 | 22,4 | 33,8 | 19,0 | 3,2 | 32,5 | 24,6 |
| CA02COM-E18-**-P-B-*** | 30,8 | 3.1 | 25,6 | 33,8 | 19,0 | 4,0 | 35,0 | 27,0 |
| CA02COM-E20-**-P-B-*** | 34,2 | 3.1 | 29,0 | 33,8 | 19,0 | 4,0 | 38,0 | 29,4 |
| CA02COM-E22-**-P-B-*** | 37,4 | 3.1 | 32,2 | 33,8 | 19,0 | 4,0 | 41,0 | 31,8 |
| CA02COM-E24-**-P-B-*** | 40,9 | 3.7 | 35,3 | 33,8 | 20,6 | 4,0 | 44,5 | 34,9 |
| CA02COM-E28-**-P-B-*** | 46,7 | 3.7 | 41,4 | 33,8 | 20,6 | 4,0 | 50,8 | 39,7 |
| CA02COM-E32-**-P-B-*** | 53,4 | 4.4 | 47,8 | 33,8 | 22,2 | 4,0 | 57,0 | 44,5 |
| CA02COM-E36-**-P-B-*** | 59,6 | 4.4 | 52,6 | 33,8 | 22,2 | 4,0 | 63,5 | 49,2 |

CA02COM-E with threaded coupling

CA02COM-E is a boxmounting receptacle for front panel mounting. It mates with plugs CA06COM and CA08COM

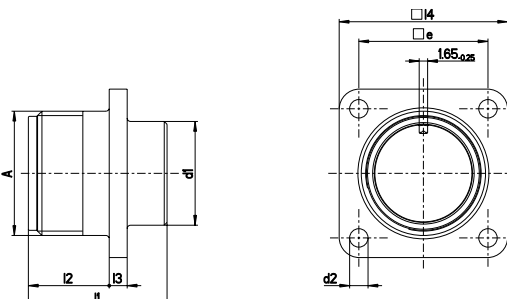

| Part No. (pin insert*) | A | d1 | d2 | l1 | l2 | l3 | l4 | e |
|------------------------|-----------------|------|-------|------|-------|-------|-------|-------|
| | Thread | max. | + 0,2 | max. | + 0,4 | ± 0,3 | ± 0,3 | ± 0,1 |
| CA02COM-E10SL-**-P-*** | 5/8-24UNEF-2A | 15,9 | 3,1 | 25,1 | 14,2 | 2,8 | 25,4 | 18,2 |
| CA02COM-E12S-**-P-*** | 3/4-20UNEF-2A | 15,9 | 3,1 | 25,1 | 14,2 | 3,2 | 28,0 | 20,6 |
| CA02COM-E14S-**-P-*** | 7/8-20UNEF-2A | 19,0 | 3,1 | 25,1 | 14,2 | 3,2 | 30,0 | 23,0 |
| CA02COM-E16S-**-P-*** | 1-20UNEF-2A | 22,2 | 3,1 | 25,1 | 14,2 | 3,2 | 32,5 | 24,6 |
| CA02COM-E16-**-P-*** | 1-20UNEF-2A | 22,2 | 3,1 | 34,2 | 19,0 | 3,2 | 32,5 | 24,6 |
| CA02COM-E18-**-P-*** | 1-1/8-18UNEF-2A | 25,4 | 3,1 | 34,2 | 19,0 | 4,0 | 35,0 | 27,0 |
| CA02COM-E20-**-P-*** | 1-1/4-18UNEF-2A | 29,0 | 3,1 | 34,2 | 19,0 | 4,0 | 38,0 | 29,4 |
| CA02COM-E22-**-P-*** | 1-3/8-18UNEF-2A | 32,2 | 3,1 | 34,2 | 19,0 | 4,0 | 41,0 | 31,8 |
| CA02COM-E24-**-P-*** | 1-1/2-18UNEF-2A | 35,3 | 3,7 | 34,2 | 20,6 | 4,0 | 44,5 | 34,9 |
| CA02COM-E28-**-P-*** | 1-3/4-18UNEF-2A | 41,2 | 3,7 | 34,2 | 20,6 | 4,0 | 50,8 | 39,7 |
| CA02COM-E32-**-P-*** | 2-18UNS-2A | 47,6 | 4,4 | 34,2 | 22,2 | 4,0 | 57,0 | 44,5 |
| CA02COM-E36-**-P-*** | 2-1/4-16UN-2A | 52,4 | 4,4 | 34,2 | 22,2 | 4,0 | 63,5 | 49,2 |

*For socket inserts substitute "S" for "P" **Add contact arrangement number; see pages 11–15 *** Add modification code; see page 10 (bottom) ¹⁾max cable dia

BOX MOUNTING RECEPTACLE CLASS E

CA20COM-E-B with bayonet coupling

CA20COM-E-B is a box mounting receptacle for rear panel mounting. It mates with plugs CA06COM-B and CA08COM-B

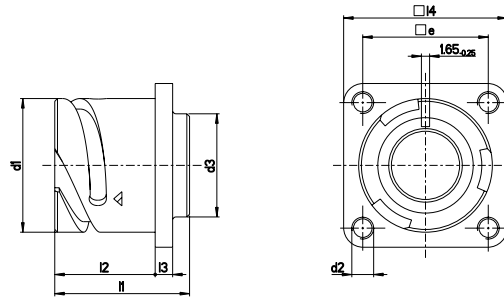

| Part No. (pin insert*) | d1 | d2 | d3 | l1 | l2 | l3 | l4 | e |
|--------------------------|-------|----|------|-------|-------|-------|-------|-------|
| | -0,15 | | max. | ± 0,3 | + 0,4 | ± 0,2 | ± 0,3 | ± 0,0 |
| CA20COM-E10SL-**-P-B-*** | 18,2 | M4 | 16,2 | 24,7 | 18,20 | 2,8 | 25,4 | 18,2 |
| CA20COM-E12S-**-P-B-*** | 21,4 | M4 | 16,2 | 24,7 | 18,20 | 3,2 | 28,0 | 20,6 |
| CA20COM-E14S-**-P-B-*** | 24,6 | M4 | 19,2 | 24,7 | 18,20 | 3,2 | 30,0 | 23,0 |
| CA20COM-E16S-**-P-B-*** | 27,4 | M4 | 22,4 | 24,7 | 18,20 | 3,2 | 32,5 | 24,6 |
| CA20COM-E16-**-P-B-*** | 27,4 | M4 | 22,4 | 33,8 | 23,05 | 3,2 | 32,5 | 24,6 |
| CA20COM-E18-**-P-B-*** | 30,8 | M4 | 25,6 | 33,8 | 23,05 | 4,0 | 35,0 | 27,0 |
| CA20COM-E20-**-P-B-*** | 34,2 | M4 | 29,0 | 33,8 | 23,05 | 4,0 | 38,0 | 29,4 |
| CA20COM-E22-**-P-B-*** | 37,4 | M4 | 32,2 | 33,8 | 23,05 | 4,0 | 41,0 | 31,8 |
| CA20COM-E24-**-P-B-*** | 40,9 | M4 | 35,3 | 33,8 | 23,05 | 4,0 | 44,5 | 34,9 |
| CA20COM-E28-**-P-B-*** | 46,7 | M5 | 41,4 | 33,8 | 24,05 | 4,0 | 50,8 | 39,7 |
| CA20COM-E32-**-P-B-*** | 53,4 | M5 | 47,8 | 33,8 | 24,05 | 4,0 | 57,0 | 44,5 |
| CA20COM-E36-**-P-B-*** | 59,6 | M5 | 52,6 | 33,8 | 24,05 | 4,0 | 63,5 | 49,2 |

CA20COM-E with threaded coupling

CA20COM-E is a box mounting receptacle for rear panel mounting. It mates with plugs CA06COM and CA08COM

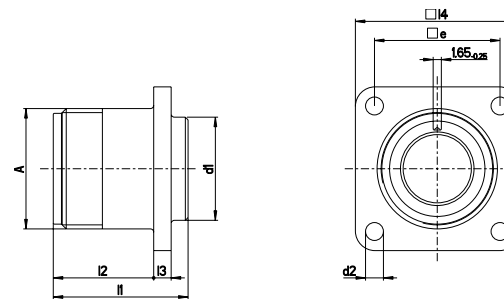

| Part No. (pin insert*) | A | d1 | d2 | | l1 | l2 | l3 | l4 | e |
|------------------------|-----------------|------|-----|------------|------|-------|-------|-------|-------|
| | Thread | max | H13 | Code: BM29 | max. | + 0,4 | ± 0,3 | ± 0,3 | ± 0,1 |
| CA20COM-E10SL-**-P-*** | 5/8-24UNEF-2A | 14,5 | 3,2 | M4 | 25,1 | 18,20 | 2,8 | 25,4 | 18,2 |
| CA20COM-E12S-**-P-*** | 3/4-20UNEF-2A | 16,1 | 3,2 | M4 | 25,1 | 18,20 | 3,2 | 28,0 | 20,6 |
| CA20COM-E14S-**-P-*** | 7/8-20UNEF-2A | 19,2 | 3,2 | M4 | 25,1 | 18,20 | 3,2 | 30,0 | 23,0 |
| CA20COM-E16S-**-P-*** | 1-20UNEF-2A | 22,4 | 3,2 | M4 | 25,1 | 18,20 | 3,2 | 32,5 | 24,6 |
| CA20COM-E16-**-P-*** | 1-20UNEF-2A | 22,4 | 3,2 | M4 | 34,2 | 21,50 | 3,2 | 32,5 | 24,6 |
| CA20COM-E18-**-P-*** | 1-1/8-18UNEF-2A | 25,6 | 3,2 | M4 | 34,2 | 23,05 | 4,0 | 35,0 | 27,0 |
| CA20COM-E20-**-P-*** | 1-1/4-18UNEF-2A | 29,0 | 3,2 | M4 | 34,2 | 23,05 | 4,0 | 38,0 | 29,4 |
| CA20COM-E22-**-P-*** | 1-3/8-18UNEF-2A | 32,2 | 3,2 | M4 | 34,2 | 23,05 | 4,0 | 41,0 | 31,8 |
| CA20COM-E24-**-P-*** | 1-1/2-18UNEF-2A | 35,3 | 3,7 | M5 | 34,2 | 24,05 | 4,0 | 44,5 | 34,9 |
| CA20COM-E28-**-P-*** | 1-3/4-18UNEF-2A | 41,4 | 3,7 | M5 | 34,2 | 24,05 | 4,0 | 50,8 | 39,7 |
| CA20COM-E32-**-P-*** | 2-18UNS-2A | 47,8 | 4,4 | M6 | 34,2 | 24,05 | 4,0 | 57,0 | 44,5 |
| CA20COM-E36-**-P-*** | 2-1/4-16UN-2A | 54,1 | 4,4 | M6 | 34,2 | 24,05 | 4,0 | 63,5 | 49,2 |

*For socket inserts substitute "S" for "P" **Add contact arrangement number; see pages 11–15 *** Add modification code; see page 10 (bottom)

BOX MOUNTING RECEPTACLE CLASS L, WITH PCB TERMINATION

CA02COM-L-B with bayonet coupling

CA02COM-L-B is a box mounting receptacle for front panel mounting with pcb termination. It mates with plugs CA06COM-B and CA08COM-B

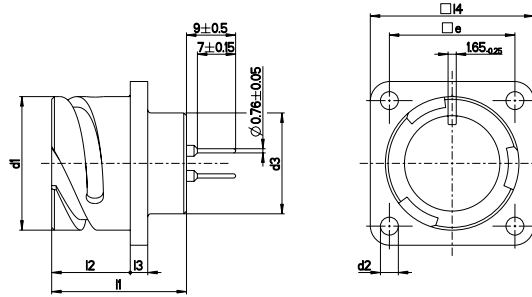
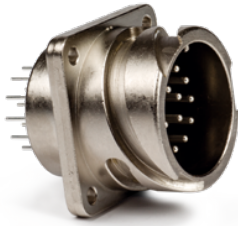

| Part No. (pin insert*) | d1 | d2 | d3 | l1 | l2 | l3 | l4 | e |
|--------------------------|-------|-----|------|-------|-------|-------|-------|-------|
| | -0,15 | H13 | max. | ± 0,3 | + 0,4 | ± 0,2 | ± 0,3 | ± 0,1 |
| CA02COM-L10SL-**-P-B-*** | 18,2 | 3,1 | 16,2 | 24,7 | 14,2 | 2,8 | 25,4 | 18,2 |
| CA02COM-L12S-**-P-B-*** | 21,4 | 3,1 | 16,2 | 24,7 | 14,2 | 3,2 | 28,0 | 20,6 |
| CA02COM-L14S-**-P-B-*** | 24,6 | 3,1 | 19,2 | 24,7 | 14,2 | 3,2 | 30,0 | 23,0 |
| CA02COM-L16S-**-P-B-*** | 27,4 | 3,1 | 22,4 | 24,7 | 14,2 | 3,2 | 32,5 | 24,6 |
| CA02COM-L16-**-P-B-*** | 27,4 | 3,1 | 22,4 | 33,8 | 19,0 | 3,2 | 32,5 | 24,6 |
| CA02COM-L18-**-P-B-*** | 30,8 | 3,1 | 25,6 | 33,8 | 19,0 | 4,0 | 35,0 | 27,0 |
| CA02COM-L20-**-P-B-*** | 34,2 | 3,1 | 29,0 | 33,8 | 19,0 | 4,0 | 38,0 | 29,4 |
| CA02COM-L22-**-P-B-*** | 37,4 | 3,1 | 32,2 | 33,8 | 19,0 | 4,0 | 41,0 | 31,8 |
| CA02COM-L24-**-P-B-*** | 40,9 | 3,7 | 35,3 | 33,8 | 20,6 | 4,0 | 44,5 | 34,9 |
| CA02COM-L28-**-P-B-*** | 46,7 | 3,7 | 41,4 | 33,8 | 20,6 | 4,0 | 50,8 | 39,7 |
| CA02COM-L32-**-P-B-*** | 53,4 | 4,4 | 47,8 | 33,8 | 22,2 | 4,0 | 57,0 | 44,5 |
| CA02COM-L36-**-P-B-*** | 59,6 | 4,4 | 52,6 | 33,8 | 22,2 | 4,0 | 63,5 | 49,2 |

CA02COM-L with threaded coupling

CA02COM-L is a box mounting receptacle for front panel mounting with pcb termination. It mates with plugs CA06COM and CA08COM

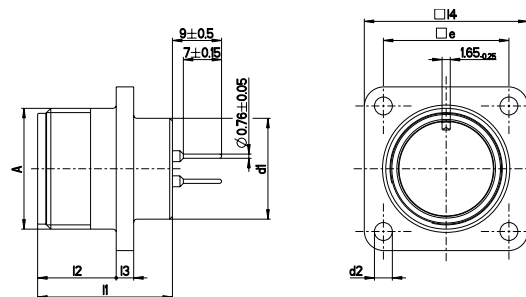
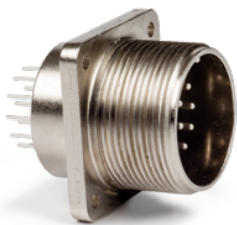

| Part No. (pin insert*) | A Thread | d1 max | d2 H13 | l1 max | l2 + 0,4 | l3 ± 0,3 | l4 ± 0,3 | e ± 0,1 |
|------------------------|-----------------|-----------|-----------|-----------|-------------|-------------|-------------|------------|
| CA02COM-L10SL-**-P-*** | 5/8-24UNEF-2A | 15,9 | 3,1 | 25,1 | 14,2 | 2,8 | 25,4 | 18,2 |
| CA02COM-L12S-**-P-*** | 3/4-20UNEF-2A | 15,9 | 3,1 | 25,1 | 14,2 | 3,2 | 28,0 | 20,6 |
| CA02COM-L14S-**-P-*** | 7/8-20UNEF-2A | 19,0 | 3,1 | 25,1 | 14,2 | 3,2 | 30,0 | 23,0 |
| CA02COM-L16S-**-P-*** | 1-20UNEF-2A | 22,2 | 3,1 | 25,1 | 14,2 | 3,2 | 32,5 | 24,6 |
| CA02COM-L16-**-P-*** | 1-20UNEF-2A | 22,2 | 3,1 | 34,2 | 19,0 | 3,2 | 32,5 | 24,6 |
| CA02COM-L18-**-P-*** | 1-1/8-18UNEF-2A | 25,4 | 3,1 | 34,2 | 19,0 | 4,0 | 35,0 | 27,0 |
| CA02COM-L20-**-P-*** | 1-1/4-18UNEF-2A | 29,0 | 3,1 | 34,2 | 19,0 | 4,0 | 38,0 | 29,4 |
| CA02COM-L22-**-P-*** | 1-3/8-18UNEF-2A | 32,2 | 3,1 | 34,2 | 19,0 | 4,0 | 41,0 | 31,8 |
| CA02COM-L24-**-P-*** | 1-1/2-18UNEF-2A | 35,3 | 3,7 | 34,2 | 20,6 | 4,0 | 44,5 | 34,9 |
| CA02COM-L28-**-P-*** | 1-3/4-18UNEF-2A | 41,2 | 3,7 | 34,2 | 20,6 | 4,0 | 50,8 | 39,7 |
| CA02COM-L32-**-P-*** | 2-18UNS-2A | 47,6 | 4,4 | 34,2 | 22,2 | 4,0 | 57,0 | 44,5 |
| CA02COM-L36-**-P-*** | 2-1/4-16UN-2A | 52,4 | 4,4 | 34,2 | 22,2 | 4,0 | 63,5 | 49,2 |

*For socket inserts substitute "S" for "P" **Add contact arrangement number; see pages 11–15 *** Add modification code; see page 10 (bottom)

BOX MOUNTING RECEPTACLE CLASS L, WITH PCB TERMINATION

CA20COM-L-B with bayonet coupling

CA20COM-L-B is a box mounting receptacle for rear panel mounting with pcb termination. It mates with plugs CA06COM-B and CA08COM-B

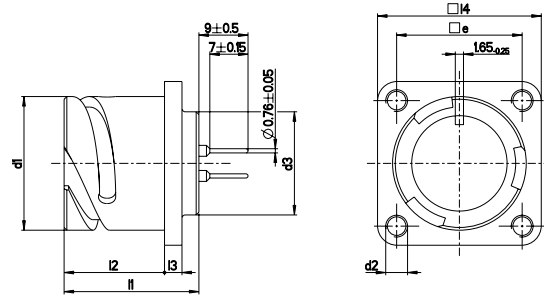
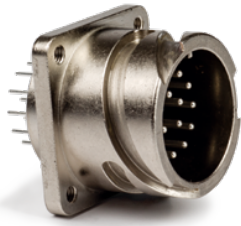

| Part No. (pin insert*) | d1 | d2 | d3 | l1 | l2 | l3 | l4 | e |
|-------------------------|-------|----|------|-------|-------|-------|-------|-------|
| | -0,15 | | max | ± 0,3 | + 0,4 | ± 0,2 | ± 0,3 | ± 0,1 |
| CA20COM-L10SL**-P-B-*** | 18,2 | M4 | 16,2 | 24,7 | 18,20 | 2,8 | 25,4 | 18,2 |
| CA20COM-L12S**-P-B-*** | 21,4 | M4 | 16,2 | 24,7 | 18,20 | 3,2 | 28,0 | 20,6 |
| CA20COM-L14S**-P-B-*** | 24,6 | M4 | 19,2 | 24,7 | 18,20 | 3,2 | 30,0 | 23,0 |
| CA20COM-L16S**-P-B-*** | 27,4 | M4 | 22,4 | 24,7 | 18,20 | 3,2 | 32,5 | 24,6 |
| CA20COM-L16**-P-B-*** | 27,4 | M4 | 22,4 | 33,8 | 23,05 | 3,2 | 32,5 | 24,6 |
| CA20COM-L18**-P-B-*** | 30,8 | M4 | 25,6 | 33,8 | 23,05 | 4,0 | 35,0 | 27,0 |
| CA20COM-L20**-P-B-*** | 34,2 | M4 | 29,0 | 33,8 | 23,05 | 4,0 | 38,0 | 29,4 |
| CA20COM-L22**-P-B-*** | 37,4 | M4 | 32,2 | 33,8 | 23,05 | 4,0 | 41,0 | 31,8 |
| CA20COM-L24**-P-B-*** | 40,9 | M4 | 35,3 | 33,8 | 23,05 | 4,0 | 44,5 | 34,9 |
| CA20COM-L28**-P-B-*** | 46,7 | M5 | 41,4 | 33,8 | 24,05 | 4,0 | 50,8 | 39,7 |
| CA20COM-L32**-P-B-*** | 53,4 | M5 | 47,8 | 33,8 | 24,05 | 4,0 | 57,0 | 44,5 |
| CA20COM-L36**-P-B-*** | 59,6 | M5 | 54,1 | 33,8 | 24,05 | 4,0 | 63,5 | 49,2 |

CA20COM-L with threaded coupling

CA20COM-L is a box mounting receptacle for rear panel mounting with pcb termination. It mates with plugs CA06COM and CA08COM

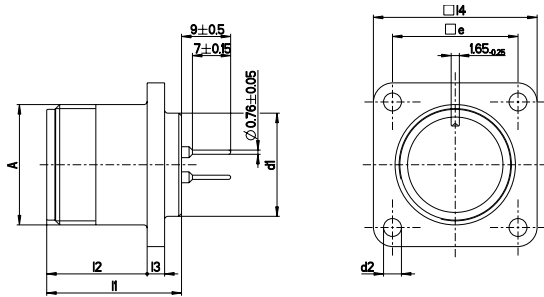

| Part No. (pin insert*) | A Thread | d1 max | d2 H13 Std | l1 max | l2 + 0,4 | l3 ± 0,3 | l4 ± 0,3 | e ± 0,1 |
|------------------------|-----------------|-----------|------------------|-----------|-------------|-------------|-------------|------------|
| | | | | BM29 | | | | |
| CA20COM-L10SL**-P-*** | 5/8-24UNEF-2A | 14,5 | 3,2 | M4 | 25,1 | 18,20 | 2,8 | 25,4 |
| CA20COM-L12S**-P-*** | 3/4-20UNEF-2A | 16,1 | 3,2 | M4 | 25,1 | 18,20 | 3,2 | 28,0 |
| CA20COM-L14S**-P-*** | 7/8-20UNEF-2A | 19,2 | 3,2 | M4 | 25,1 | 18,20 | 3,2 | 30,0 |
| CA20COM-L16S**-P-*** | 1-20UNEF-2A | 22,4 | 3,2 | M4 | 25,1 | 18,20 | 3,2 | 32,5 |
| CA20COM-L16**-P-*** | 1-20UNEF-2A | 22,4 | 3,2 | M4 | 34,2 | 21,50 | 3,2 | 32,5 |
| CA20COM-L18**-P-*** | 1-1/8-18UNEF-2A | 25,6 | 3,2 | M4 | 34,2 | 23,05 | 4,0 | 35,0 |
| CA20COM-L20**-P-*** | 1-1/4-18UNEF-2A | 29,0 | 3,2 | M4 | 34,2 | 23,05 | 4,0 | 38,0 |
| CA20COM-L22**-P-*** | 1-3/8-18UNEF-2A | 32,2 | 3,2 | M4 | 34,2 | 23,05 | 4,0 | 41,0 |
| CA20COM-L24**-P-*** | 1-1/2-18UNEF-2A | 35,3 | 3,7 | M5 | 34,2 | 24,05 | 4,0 | 44,5 |
| CA20COM-L28**-P-*** | 1-3/4-18UNEF-2A | 41,4 | 3,7 | M5 | 34,2 | 24,05 | 4,0 | 50,8 |
| CA20COM-L32**-P-*** | 2-18UNS-2A | 47,8 | 4,4 | M6 | 34,2 | 24,05 | 4,0 | 57,0 |
| CA20COM-L36**-P-*** | 2-1/4-16UN-2A | 54,1 | 4,4 | M6 | 34,2 | 24,05 | 4,0 | 63,5 |

*For socket inserts substitute "S" for "P" **Add contact arrangement number; see pages 11–15 *** Add modification code; see page 10 (bottom)

STRAIGHT PLUG PG OR METRIC ADAPTER

CA06COM-PG/ME-B with bayonet coupling

CA06COM-PG/ME-B is a straight plug for usage of PG and metric terminations. It mates with receptacles CA00COM-B, CA01COM-B, CA02COM-E-B and CA20COM-E-B

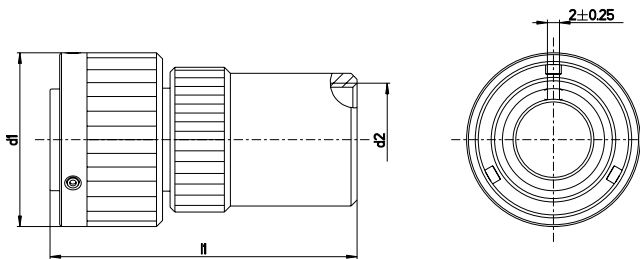

| Part No. (pin insert*) | | d1 max | d2 PG-Thread | Metric | l1 max |
|-------------------------|------------------------|-----------|-----------------|-----------|-----------|
| CA06COM-PG10SL**P-B-*** | CA06COM-ME10SL*P-B-*** | 22,8 | PG9 | M16 × 1,5 | 52,0 |
| CA06COM-PG12S**P-B-*** | CA06COM-ME12S**P-B-*** | 26,0 | PG9 | M16 × 1,5 | 52,0 |
| CA06COM-PG14S**P-B-*** | CA06COM-ME14S**P-B-*** | 29,2 | PG11 | M20 × 1,5 | 52,0 |
| CA06COM-PG16S**P-B-*** | CA06COM-ME16S*P-B-*** | 32,0 | PG13,5 | M20 × 1,5 | 54,0 |
| CA06COM-PG16**P-B-*** | CA06COM-ME16**P-B-*** | 32,0 | PG13,5 | M20 × 1,5 | 64,0 |
| CA06COM-PG18**P-B-*** | CA06COM-ME18**P-B-*** | 36,5 | PG13,5 | M25 × 1,5 | 69,0 |
| CA06COM-PG20**P-B-*** | CA06COM-ME20**P-B-*** | 39,9 | PG16 | M25 × 1,5 | 70,0 |
| CA06COM-PG22**P-B-*** | CA06COM-ME22**P-B-*** | 42,1 | PG16 | M32 × 1,5 | 73,0 |
| CA06COM-PG24**P-B-*** | CA06COM-ME24**P-B-*** | 46,6 | PG16 | M32 × 1,5 | 74,0 |
| CA06COM-PG28**P-B-*** | CA06COM-ME28**P-B-*** | 53,4 | PG21 | M32 × 1,5 | 74,0 |
| CA06COM-PG32**P-B-*** | CA06COM-ME32**P-B-*** | 60,1 | PG29 | M40 × 1,5 | 76,0 |
| CA06COM-PG36**P-B-*** | CA06COM-ME36**P-B-*** | 66,3 | PG29 | M40 × 1,5 | 87,0 |

CA06COM-PG/ME with threaded coupling

CA06COM-PG/ME is a straight plug for usage of PG and metric terminations. It mates with receptacles CA00COM, CA01COM, CA02COM-E and CA20COM-E

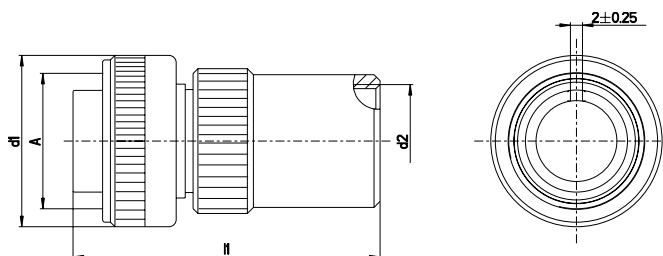

| Part No. (pin insert*) | | A Thread | d1 max | d2 PG-Thread | Metric | l1 max |
|------------------------|----------------------|-----------------|-----------|-----------------|-----------|-----------|
| CA06COM-PG10SL**P-*** | CA06COM-ME10SL*P-*** | 5/8-24UNEF-2B | 24,1 | PG9 | M16 × 1,5 | 52,0 |
| CA06COM-PG12S**P-*** | CA06COM-ME12S**P-*** | 3/4-20UNEF-2B | 25,8 | PG9 | M16 × 1,5 | 52,0 |
| CA06COM-PG14S**P-*** | CA06COM-ME14S**P-*** | 7/8-20UNEF-2B | 28,8 | PG11 | M20 × 1,5 | 52,0 |
| CA06COM-PG16S**P-*** | CA06COM-ME16S*P-*** | 1-20UNEF-2B | 31,8 | PG13,5 | M20 × 1,5 | 54,0 |
| CA06COM-PG16**P-*** | CA06COM-ME16**P-*** | 1-20UNEF-2B | 31,8 | PG13,5 | M20 × 1,5 | 64,0 |
| CA06COM-PG18**P-*** | CA06COM-ME18**P-*** | 1-1/8-18UNEF-2B | 34,1 | PG13,5 | M25 × 1,5 | 69,0 |
| CA06COM-PG20**P-*** | CA06COM-ME20**P-*** | 1-1/4-18UNEF-2B | 37,4 | PG16 | M25 × 1,5 | 70,0 |
| CA06COM-PG22**P-*** | CA06COM-ME22**P-*** | 1-3/8-18UNEF-2B | 40,5 | PG16 | M32 × 1,5 | 73,0 |
| CA06COM-PG24**P-*** | CA06COM-ME24**P-*** | 1-1/2-18UNEF-2B | 43,8 | PG16 | M32 × 1,5 | 74,0 |
| CA06COM-PG28**P-*** | CA06COM-ME28**P-*** | 1-3/4-18UNEF-2B | 50,2 | PG21 | M32 × 1,5 | 74,0 |
| CA06COM-PG32**P-*** | CA06COM-ME32**P-*** | 2-18UNS-2B | 56,4 | PG29 | M40 × 1,5 | 76,0 |
| CA06COM-PG36**P-*** | CA06COM-ME36**P-*** | 2-1/4-16UN-2B | 62,8 | PG29 | M40 × 1,5 | 87,0 |

* For socket inserts substitute "S" for "P" ** Add contact arrangement number; see pages 11–15 *** Add modification code; see page 10 (bottom)

STRAIGHT PLUG CLASS E

CA06COM-E-B with bayonet coupling

CA06COM-E-B is a straight plug with endbell and cable clamp. It mates with receptacles CA00COM-B CA01COM-B, CA02COM-E-B and CA20COM-E-B

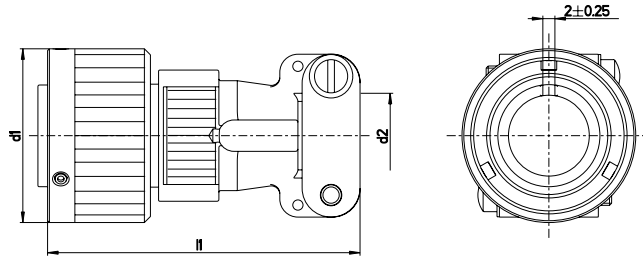

| Part No. (pin insert*) | d1 max. | d2 ¹⁾ max. | l1 |
|-------------------------|------------|--------------------------|----|
| CA06COM-E10SL-**P-B-*** | 22,8 | 7,9 | 53 |
| CA06COM-E12S-**P-B-*** | 26,0 | 7,9 | 53 |
| CA06COM-E14S-**P-B-*** | 29,2 | 11,1 | 55 |
| CA06COM-E16S-**P-B-*** | 32,0 | 14,2 | 56 |
| CA06COM-E16-**P-B-*** | 32,0 | 14,2 | 66 |
| CA06COM-E18-**P-B-*** | 36,5 | 15,8 | 68 |
| CA06COM-E20-**P-B-*** | 39,9 | 19,0 | 68 |
| CA06COM-E22-**P-B-*** | 43,1 | 19,0 | 68 |
| CA06COM-E24-**P-B-*** | 46,6 | 23,7 | 76 |
| CA06COM-E28-**P-B-*** | 53,4 | 23,7 | 76 |
| CA06COM-E32-**P-B-*** | 60,1 | 31,8 | 76 |
| CA06COM-E36-**P-B-*** | 66,3 | 34,6 | 76 |

CA06COM-E with threaded coupling

CA06COM-E is a straight plug with endbell and cable clamp. It mates with receptacles CA00COM, CA01COM, CA02COM-E and CA20COM-E

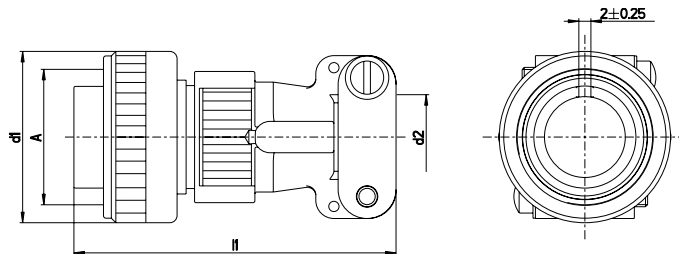

| Part No. (pin insert*) | A Thread | d1 max | d2 ¹⁾ max. | l1 max. |
|------------------------|-----------------|-----------|--------------------------|------------|
| CA06COM-E10SL-**P-*** | 5/8-24UNEF-2B | 24,1 | 7,9 | 53 |
| CA06COM-E12S-**P-*** | 3/4-20UNEF-2B | 25,8 | 7,9 | 53 |
| CA06COM-E14S-**P-*** | 7/8-20UNEF-2B | 28,8 | 11,1 | 55 |
| CA06COM-E16S-**P-*** | 1-20UNEF-2B | 31,8 | 14,2 | 56 |
| CA06COM-E16-**P-*** | 1-20UNEF-2B | 31,8 | 14,2 | 66 |
| CA06COM-E18-**P-*** | 1-1/8-18UNEF-2B | 34,1 | 15,8 | 68 |
| CA06COM-E20-**P-*** | 1-1/4-18UNEF-2B | 37,4 | 19,0 | 68 |
| CA06COM-E22-**P-*** | 1-3/8-18UNEF-2B | 40,5 | 19,0 | 68 |
| CA06COM-E24-**P-*** | 1-1/2-18UNEF-2B | 43,8 | 23,7 | 76 |
| CA06COM-E28-**P-*** | 1-3/4-18UNS-2B | 50,2 | 23,7 | 76 |
| CA06COM-E32-**P-*** | 2-18UNS-2B | 56,4 | 31,8 | 76 |
| CA06COM-E36-**P-*** | 2-1/4-16UN-2B | 62,8 | 34,6 | 76 |

*For socket inserts substitute "S" for "P" **Add contact arrangement number; see pages 11–15 *** Add modification code; see page 10 (bottom) ¹⁾max cable dia

STRAIGHT PLUG CLASS F

CA06COM-F-B with bayonet coupling

CA06COM-F-B is a straight plug with endbell for flex tubes. It mates with receptacles CA00COM-B, CA01COM-B, CA02COM-E-B and CA20COM-E-B

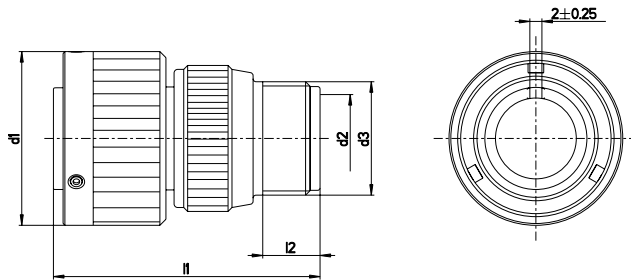

| Part No. (pin insert*) | d1 | d2 ¹⁾ | l2 | l1 |
|--------------------------|------|------------------|------|-----|
| | max | max | min | max |
| CA06COM-F10SL-**-P-B-*** | 22,8 | 8,2 | 9,5 | 45 |
| CA06COM-F12S-**-P-B-*** | 26,0 | 8,2 | 9,5 | 45 |
| CA06COM-F14S-**-P-B-*** | 29,2 | 11,1 | 9,5 | 45 |
| CA06COM-F16S-**-P-B-*** | 32,0 | 14,3 | 9,5 | 45 |
| CA06COM-F16-**-P-B-*** | 32,0 | 14,3 | 9,5 | 54 |
| CA06COM-F18-**-P-B-*** | 36,5 | 16,7 | 9,5 | 54 |
| CA06COM-F20-**-P-B-*** | 39,9 | 19,8 | 9,5 | 55 |
| CA06COM-F22-**-P-B-*** | 43,1 | 19,8 | 9,5 | 58 |
| CA06COM-F24-**-P-B-*** | 46,6 | 25,4 | 9,5 | 59 |
| CA06COM-F28-**-P-B-*** | 53,4 | 27,0 | 9,5 | 59 |
| CA06COM-F32-**-P-B-*** | 60,1 | 32,5 | 11,0 | 62 |
| CA06COM-F36-**-P-B-*** | 66,3 | 35,7 | 11,8 | 64 |

CA06COM-F with threaded coupling

CA06COM-F is a straight plug with endbell for flex tubes. It mates with receptacles CA00COM, CA01COM, CA02COM-E and CA20COM-E

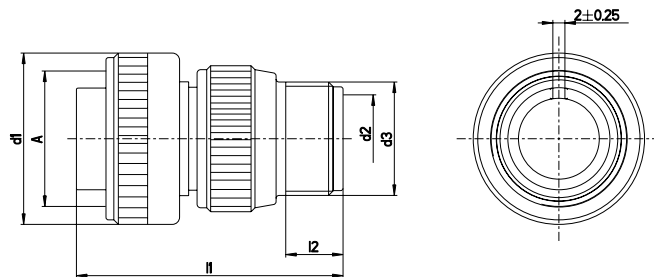

| Part No. (pin insert*) | A | d1 | d2 ¹⁾ | d3 | l1 | l2 |
|------------------------|-----------------|------|------------------|------------------|-----|------|
| | Thread | max | | Thread | max | min |
| CA06COM-F10SL-**-P-*** | 5/8-24UNEF-2B | 24,1 | 8,2 | 5/8-24UNEF-2A | 45 | 9,5 |
| CA06COM-F12S-**-P-*** | 3/4-20UNEF-2B | 25,8 | 8,2 | 5/8-20UNEF-2A | 45 | 9,5 |
| CA06COM-F14S-**-P-*** | 7/8-20UNEF-2B | 28,8 | 11,1 | 3/4-20UNEF-2A | 45 | 9,5 |
| CA06COM-F16S-**-P-*** | 1-20UNEF-2B | 31,8 | 14,3 | 7/8-20UNEF-2A | 45 | 9,5 |
| CA06COM-F16-**-P-*** | 1-20UNEF-2B | 31,8 | 14,3 | 7/8-20UNEF-2A | 54 | 9,5 |
| CA06COM-F18-**-P-*** | 1-1/8-18UNEF-2B | 34,1 | 16,7 | 1-20UNEF-2A | 54 | 9,5 |
| CA06COM-F20-**-P-*** | 1-1/4-18UNEF-2B | 37,4 | 19,8 | 1-3/16-18UNEF-2A | 55 | 9,5 |
| CA06COM-F22-**-P-*** | 1-3/8-18UNEF-2B | 40,5 | 19,8 | 1-3/16-18UNEF-2A | 58 | 9,5 |
| CA06COM-F24-**-P-*** | 1-1/2-18UNEF-2B | 43,8 | 25,4 | 1-7/16-18UNEF-2A | 59 | 9,5 |
| CA06COM-F28-**-P-*** | 1-3/4-18UNEF-2B | 50,2 | 27,0 | 1-7/16-18UNEF-2A | 60 | 9,5 |
| CA06COM-F32-**-P-*** | 2-18UNS-2B | 56,4 | 32,5 | 1-3/4-18UNS-2A | 62 | 11,0 |
| CA06COM-F36-**-P-*** | 2-1/4-16UN-2B | 62,8 | 35,7 | 2-18UNS-2A | 64 | 11,8 |

* For socket inserts substitute "S" for "P" ** Add contact arrangement number; see pages 11–15 *** Add modification code; see page 10 (bottom) ¹⁾ max cable dia

STRAIGHT PLUG CLASS E

CA06COM-E-B/-03/-06 with bayonet coupling

CA06COM-E-B/-03/-06 is a straight plug with endbell (wire sealing) for heat shrink boots. It mates with receptacles CA00COM-B, CA01COM-B, CA02COM-E-B and CA20COM-E-B

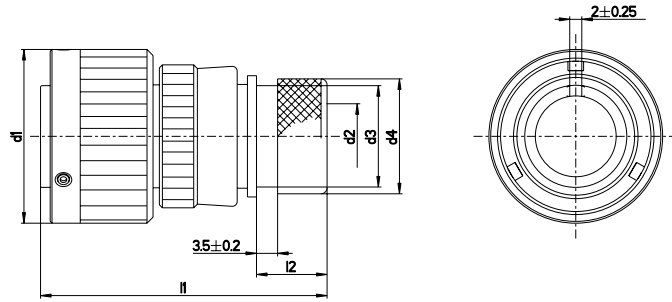

| Part No. (pin insert*) | d1 | d2 ¹⁾ | d3 | d4 | l1 | l2 |
|-------------------------|------|------------------|------|-------|-----|-------|
| | max | | max | ± 0,2 | max | ± 0,5 |
| CA06COM-E10SL-**P-B-*** | 22,8 | 7,7 | 13,3 | 15,5 | 49 | 11,7 |
| CA06COM-E12S-**P-B-*** | 26,0 | 7,9 | 13,3 | 15,5 | 49 | 11,7 |
| CA06COM-E14S-**P-B-*** | 29,2 | 10,6 | 17,0 | 19,1 | 49 | 11,7 |
| CA06COM-E16S-**P-B-*** | 32,0 | 13,5 | 21,9 | 23,9 | 49 | 11,7 |
| CA06COM-E16-**P-B-*** | 32,0 | 13,5 | 21,9 | 23,9 | 58 | 11,5 |
| CA06COM-E18-**P-B-*** | 36,5 | 14,6 | 21,9 | 23,9 | 58 | 11,5 |
| CA06COM-E20-**P-B-*** | 39,9 | 18,7 | 26,2 | 29,6 | 60 | 12,7 |
| CA06COM-E22-**P-B-*** | 43,1 | 20,8 | 26,2 | 29,6 | 60 | 12,7 |
| CA06COM-E24-**P-B-*** | 46,6 | 24,6 | 34,5 | 37,8 | 63 | 12,7 |
| CA06COM-E28-**P-B-*** | 53,4 | 27,0 | 34,5 | 37,8 | 63 | 12,7 |
| CA06COM-E32-**P-B-*** | 60,1 | 33,3 | 43,6 | 47,8 | 67 | 15,2 |
| CA06COM-E36-**P-B-*** | 66,3 | 38,5 | 43,6 | 47,8 | 68 | 15,2 |

CA06COM-E-DN with threaded coupling

CA06COM-E-DN is a straight plug with endbell (wire sealing) for heat shrink boots. It mates with receptacles CA00COM, CA01COM and CA02COM-E and CA20COM-E

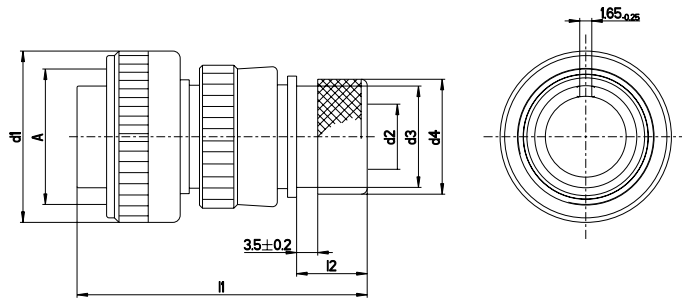

| Part No. (pin insert*) | A | d1 | d2 ¹⁾ | d3 | d4 | l1 | l2 |
|------------------------|-----------------|------|------------------|------|-------|-----|-------|
| | Thread | max | max | max | ± 0,2 | max | ± 0,5 |
| CA06COM-E10SL-**P-DN | 5/8-24UNEF-2B | 24,1 | 7,7 | 13,3 | 15,5 | 49 | 11,7 |
| CA06COM-E12S-**P-DN | 3/4-20UNEF-2B | 25,8 | 7,9 | 13,3 | 15,5 | 49 | 11,7 |
| CA06COM-E14S-**P-DN | 7/8-20UNEF-2B | 28,8 | 10,6 | 17,0 | 19,1 | 49 | 11,7 |
| CA06COM-E16S-**P-DN | 1-20UNEF-2B | 31,8 | 13,5 | 21,9 | 23,9 | 49 | 11,7 |
| CA06COM-E16-**P-DN | 1-20UNEF-2B | 31,8 | 13,5 | 21,9 | 23,9 | 58 | 11,5 |
| CA06COM-E18-**P-DN | 1-1/8-18UNEF-2B | 34,1 | 14,6 | 21,9 | 23,9 | 58 | 11,5 |
| CA06COM-E20-**P-DN | 1-1/4-18UNEF-2B | 37,4 | 18,7 | 26,2 | 29,6 | 60 | 12,7 |
| CA06COM-E22-**P-DN | 1-3/8-18UNEF-2B | 40,5 | 20,8 | 26,2 | 29,6 | 60 | 12,7 |
| CA06COM-E24-**P-DN | 1-1/2-18UNEF-2B | 43,8 | 24,6 | 34,5 | 37,8 | 63 | 12,7 |
| CA06COM-E28-**P-DN | 1-3/4-18UNEF-2B | 50,2 | 27,0 | 34,5 | 37,8 | 63 | 12,7 |
| CA06COM-E32-**P-DN | 2-18UNS-2B | 56,4 | 33,3 | 43,6 | 47,8 | 67 | 15,2 |
| CA06COM-E36-**P-DN | 2-1/4-16UN-2B | 62,8 | 38,5 | 43,6 | 47,8 | 68 | 15,2 |

*For socket inserts substitute "S" for "P" **Add contact arrangement number; see pages 11–15 *** -03: with metric crimp contacts, -06: with solder pot contacts ¹⁾max cable dia

90° PLUG CLASS E

CA08COM-E-B with bayonet coupling

CA08COM-E-B is a 90° plug with cable clamp. It mates with receptacles CA00COM-B, CA01COM-B, CA02COM-E-B and CA20COM-E-B

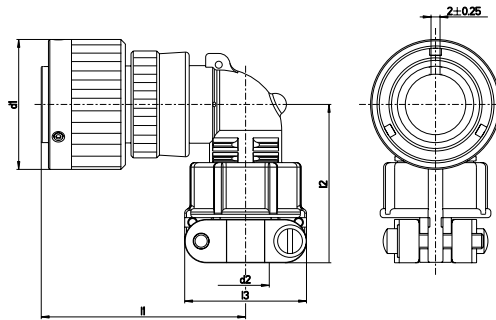

| Part No. (pin insert*) | d1 | d2 ¹⁾ | l1 | l2 | l3 |
|-------------------------|------|------------------|-----|-----|------|
| | max | | max | max | max |
| CA08COM-E10SL-**P-B-*** | 22,8 | 7,9 | 45 | 42 | 22,7 |
| CA08COM-E12S-**P-B-*** | 26,0 | 7,9 | 45 | 42 | 22,7 |
| CA08COM-E14S-**P-B-*** | 29,2 | 11,1 | 47 | 42 | 27,5 |
| CA08COM-E16S-**P-B-*** | 32,0 | 14,2 | 48 | 45 | 30,0 |
| CA08COM-E16-**P-B-*** | 32,0 | 14,2 | 48 | 45 | 30,0 |
| CA08COM-E18-**P-B-*** | 36,5 | 15,8 | 58 | 53 | 33,0 |
| CA08COM-E20-**P-B-*** | 39,9 | 19,0 | 61 | 53 | 37,5 |
| CA08COM-E22-**P-B-*** | 43,1 | 19,0 | 61 | 53 | 37,5 |
| CA08COM-E24-**P-B-*** | 46,6 | 23,7 | 66 | 58 | 43,3 |
| CA08COM-E28-**P-B-*** | 53,4 | 23,7 | 66 | 58 | 43,3 |
| CA08COM-E32-**P-B-*** | 60,1 | 31,8 | 72 | 66 | 51,7 |
| CA08COM-E36-**P-B-*** | 66,3 | 34,6 | 75 | 69 | 58,0 |

CA08COM-E with threaded coupling

CA08COM-E is a 90° plug with cable clamp. It mates with receptacles CA00COM, CA01COM, CA02COM-E and CA20COM-E

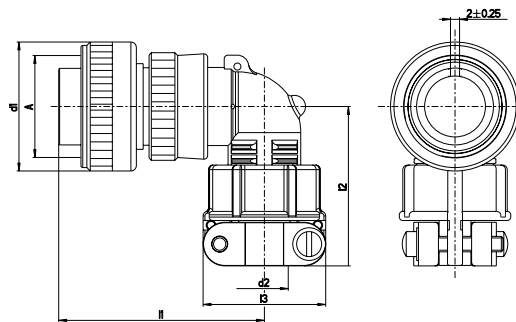

| Part No. (pin insert*) | A | d1 | d2 ¹⁾ | l1 | l2 | l3 |
|------------------------|-----------------|------|------------------|-----|-----|------|
| | Thread | max | | max | max | max |
| CA08COM-E10SL-**P-*** | 5/8-24UNEF-2B | 24,1 | 7,9 | 45 | 42 | 22,7 |
| CA08COM-E12S-**P-*** | 3/4-20UNEF-2B | 25,8 | 7,9 | 45 | 42 | 22,7 |
| CA08COM-E14S-**P-*** | 7/8-20UNEF-2B | 28,8 | 11,1 | 47 | 42 | 27,5 |
| CA08COM-E16S-**P-*** | 1-20UNEF-2B | 31,8 | 14,2 | 48 | 45 | 30,0 |
| CA08COM-E16-**P-*** | 1-20UNEF-2B | 31,8 | 14,2 | 48 | 45 | 30,0 |
| CA08COM-E18-**P-*** | 1-1/8-18UNEF-2B | 34,1 | 15,8 | 58 | 53 | 33,0 |
| CA08COM-E20-**P-*** | 1-1/4-18UNEF-2B | 37,4 | 19,0 | 61 | 53 | 37,5 |
| CA08COM-E22-**P-*** | 1-3/8-18UNEF-2B | 40,5 | 19,0 | 61 | 53 | 37,5 |
| CA08COM-E24-**P-*** | 1-1/2-18UNEF-2B | 43,8 | 23,7 | 66 | 58 | 43,3 |
| CA08COM-E28-**P-*** | 1-3/4-18UNEF-2B | 50,2 | 23,7 | 66 | 58 | 43,3 |
| CA08COM-E32-**P-*** | 2-18UNS-2B | 56,4 | 31,8 | 72 | 66 | 51,7 |
| CA08COM-E36-**P-*** | 2-1/4-16UN-2B | 62,8 | 34,6 | 75 | 69 | 58,0 |

*For socket inserts substitute "S" for "P" **Add contact arrangement number; see pages 11–15 *** Add modification code; see page 10 (bottom) ¹⁾max cable dia

90° PLUG CLASS F

CA08COM-F-B with bayonet coupling

CA08COM-F-B is a 90° plug for flex tubes. It mates with receptacles CA00COM-B, CA01COM-B, CA02COM-E-B and CA20COM-E-B

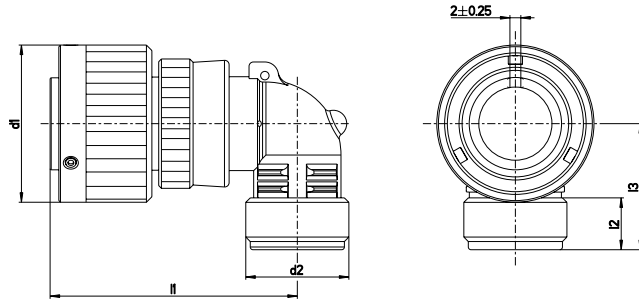

| Part No. (pin insert*) | d1 max | d2 Thread | l1 max | l2 min | l3 max |
|-------------------------|-----------|------------------|-----------|-----------|-----------|
| CA08COM-F10SL-**P-B-*** | 22,8 | 5/8-24UNEF-2B | 45 | 9,4 | 22,0 |
| CA08COM-F12S-**P-B-*** | 26,0 | 5/8-20UNEF-2B | 45 | 9,4 | 22,0 |
| CA08COM-F14S-**P-B-*** | 29,2 | 3/4-20UNEF-2B | 47 | 9,4 | 24,0 |
| CA08COM-F16S-**P-B-*** | 32,0 | 7/8-20UNEF-2B | 48 | 9,4 | 25,0 |
| CA08COM-F16-**P-B-*** | 32,0 | 7/8-20UNEF-2B | 57 | 9,4 | 25,0 |
| CA08COM-F18-**P-B-*** | 36,5 | 1-20UNEF-2B | 58 | 9,4 | 27,0 |
| CA08COM-F20-**P-B-*** | 39,9 | 1-3/16-18UNEF-2B | 61 | 9,4 | 29,0 |
| CA08COM-F22-**P-B-*** | 43,1 | 1-3/16-18UNEF-2B | 61 | 9,4 | 30,0 |
| CA08COM-F24-**P-B-*** | 46,6 | 1-7/16-18UNEF-2B | 66 | 9,4 | 32,0 |
| CA08COM-F28-**P-B-*** | 53,4 | 1-7/16-18UNEF-2B | 66 | 9,4 | 34,0 |
| CA08COM-F32-**P-B-*** | 60,1 | 1-3/4-18UNS-2B | 72 | 11,0 | 39,5 |
| CA08COM-F36-**P-B-*** | 66,3 | 2-18UNS-2B | 75 | 12,6 | 45,0 |

CA08COM-F with threaded coupling

CA08COM-F is a 90° plug for flex tubes. It mates with receptacles CA00COM, CA01COM, CA02COM-E and CA20COM-E

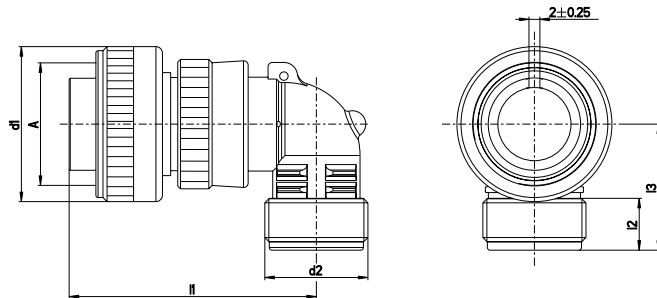

| Part No. (pin insert*) | A Thread | d1 max | d2 Thread | l1 max | l2 min | l3 max |
|------------------------|-----------------|-----------|------------------|-----------|-----------|-----------|
| CA08COM-F10SL-**P-*** | 5/8-24UNEF-2B | 24,1 | 5/8-24UNEF-2A | 45 | 9,4 | 22,0 |
| CA08COM-F12S-**P-*** | 3/4-20UNEF-2B | 25,8 | 5/8-20UNEF-2A | 45 | 9,4 | 22,0 |
| CA08COM-F14S-**P-*** | 7/8-20UNEF-2B | 28,8 | 3/4-20UNEF-2A | 47 | 9,4 | 24,0 |
| CA08COM-F16S-**P-*** | 1-20UNEF-2B | 31,8 | 7/8-20UNEF-2A | 48 | 9,4 | 25,0 |
| CA08COM-F16-**P-*** | 1-20UNEF-2B | 31,8 | 7/8-20UNEF-2A | 48 | 9,4 | 25,0 |
| CA08COM-F18-**P-*** | 1-1/8-18UNEF-2B | 34,1 | 1-20UNEF-2A | 58 | 9,4 | 27,0 |
| CA08COM-F20-**P-*** | 1-1/4-18UNEF-2B | 37,4 | 1-3/16-18UNEF-2A | 61 | 9,4 | 29,0 |
| CA08COM-F22-**P-*** | 1-3/8-18UNEF-2B | 40,5 | 1-3/16-18UNEF-2A | 61 | 9,4 | 30,0 |
| CA08COM-F24-**P-*** | 1-1/2-18UNEF-2B | 43,8 | 1-7/16-18UNEF-2A | 66 | 9,4 | 32,0 |
| CA08COM-F28-**P-*** | 1-3/4-18UNEF-2B | 50,2 | 1-7/16-18UNEF-2A | 66 | 9,4 | 34,0 |
| CA08COM-F32-**P-*** | 2-18UNS-2B | 56,4 | 1-3/4-18UNS-2A | 72 | 11,0 | 39,5 |
| CA08COM-F36-**P-*** | 2-1/4-16UN-2B | 62,8 | 2-18UNS-2A | 75 | 12,6 | 45,0 |

*For socket inserts substitute "S" for "P" **Add contact arrangement number; see pages 11–15 *** Add modification code; see page 10 (bottom)

90° PLUG CLASS PG (METRIC THREAD OPTION UNAVAILABLE)

CA08COM-PG-B with bayonet coupling

CA08COM-PG-B designates a 90° plug for usage of PG terminations. It mates with receptacles CA00COM-B, CA01COM-B, CA02COM-E-B and CA20COM-E-B

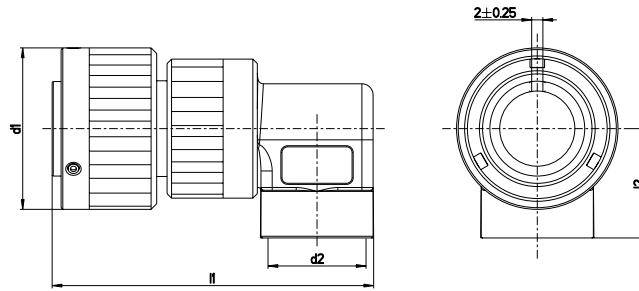

| Part No. (pin insert*) | d1 max. | d2 | l1 max | l2 ± 0,5 |
|-------------------------|------------|--------|-----------|-------------|
| CA08COM-E10SL-**P-B-*** | 22.8 | PG9 | 57 | 18.5 |
| CA08COM-E12S-**P-B-*** | 26.0 | PG9 | 57 | 18.5 |
| CA08COM-E14S-**P-B-*** | 29.2 | PG11 | 59 | 19.5 |
| CA08COM-E16S-**P-B-*** | 32.0 | PG13,5 | 63 | 22.0 |
| CA08COM-E16-**P-B-*** | 32.0 | PG13,5 | 72 | 22.0 |
| CA08COM-E18-**P-B-*** | 36.5 | PG16 | 77 | 26.3 |
| CA08COM-E20-**P-B-*** | 39.9 | PG21 | 82 | 29.0 |
| CA08COM-E22-**P-B-*** | 43.1 | PG21 | 82 | 29.5 |

CA08COM-PG with threaded coupling

CA08COM-PG designates a 90° plug for usage of PG terminations. It mates with receptacles CA00COM, CA01COM, CA02COM-E and CA20COM

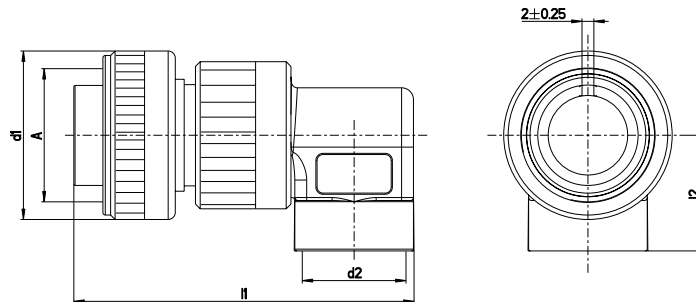

| Part No. (pin insert*) | A Thread | d1 max. | d2 | l1 max | l2 ± 0,5 |
|------------------------|-----------------|------------|--------|-----------|-------------|
| CA08COM-E10SL-**P-*** | 5/8-24UNEF-2B | 24.1 | PG9 | 57 | 18.5 |
| CA08COM-E12S-**P-*** | 3/4-20UNEF-2B | 25.8 | PG9 | 57 | 18.5 |
| CA08COM-E14S-**P-*** | 7/8-20UNEF-2B | 28.8 | PG11 | 59 | 19.5 |
| CA08COM-E16S-**P-*** | 1-20UNEF-2B | 31.8 | PG13,5 | 63 | 22.0 |
| CA08COM-E16-**P-*** | 1-20UNEF-2B | 31.8 | PG13,5 | 72 | 22.0 |
| CA08COM-E18-**P-*** | 1-1/8-20UNEF-2B | 34.1 | PG16 | 77 | 26.3 |
| CA08COM-E20-**P-*** | 1-1/4-20UNEF-2B | 37.4 | PG21 | 82 | 29.0 |
| CA08COM-E22-**P-*** | 1-3/8-20UNEF-2B | 40.5 | PG21 | 82 | 29.5 |

* For socket inserts substitute "S" for "P" ** Add contact arrangement number; see pages 11–15 *** Add modification code; see page 10 (bottom) ¹⁾max cable dia

ACCESSORIES

PROTECTIVE CAPS

with cord for receptacles with bayonet coupling. It mates with receptacles CA00COM-B, CA01COM-E-B and CA02COM-E-B CA20COM-E-B

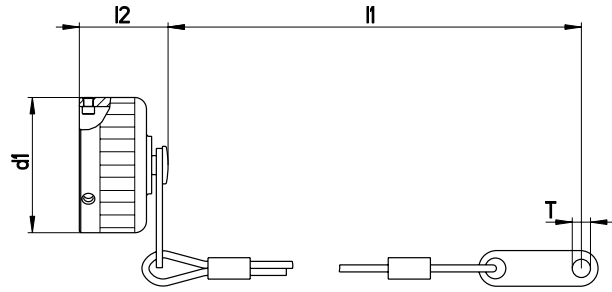

| Part No. | Shell size | d1 max | l1 ± 10 | l2 max | T + 0,25 |
|---------------|------------|-----------|------------|-----------|-------------|
| CA121003-1701 | 10SL | 22.4 | 100 | 16 | 4.3 |
| CA121003-1702 | 12S | 25.6 | 100 | 16 | 4.3 |
| CA121003-1703 | 14S | 28.8 | 100 | 16 | 4.3 |
| CA121003-1704 | 16S | 31.6 | 100 | 16 | 4.3 |
| CA121003-1705 | 16 | 31.6 | 113 | 16 | 4.3 |
| CA121003-1706 | 18 | 35.7 | 113 | 16 | 4.3 |
| CA121003-1707 | 20 | 39.1 | 127 | 16 | 4.3 |
| CA121003-1708 | 22 | 42.3 | 127 | 16 | 4.3 |
| CA121003-1709 | 24 | 45.8 | 127 | 16 | 4.3 |
| CA121003-1710 | 28 | 51.6 | 169 | 18 | 5.5 |
| CA121003-1711 | 32 | 58.3 | 169 | 18 | 5.5 |
| CA121003-1712 | 36 | 64.5 | 169 | 18 | 5.5 |

PROTECTIVE CAPS

with cord for receptacles with threaded coupling. It mates with receptacles CA00COM, CA01COM and CA02COM and CA20COM

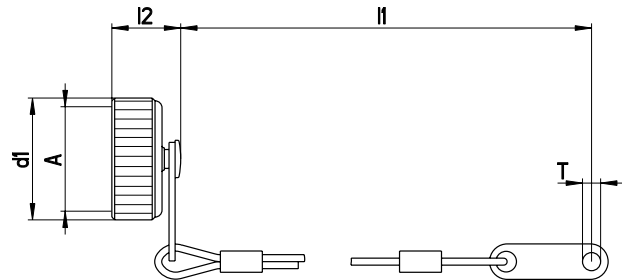

| Part No. | Shell size | A Thread | d1 max | l1 max | l2 max | T + 0,2 |
|---------------|------------|-----------------|-----------|-----------|-----------|------------|
| CA121003-1601 | 10 SL | 5/8-24UNEF-2B | 20.2 | 100 | 16,0 | 3.6 |
| CA121003-1602 | 12S | 3/4-20UNEF-2B | 23,4 | 120 | 16,0 | 3.6 |
| CA121003-1603 | 14S | 7/8-20UNEF-2B | 26.6 | 120 | 16,0 | 3.6 |
| CA121003-1604 | 16S,16 | 1-20UNEF-2B | 29.8 | 120 | 16,0 | 3.6 |
| CA121003-1606 | 18 | 1-1/8-18UNEF-2B | 32.9 | 120 | 16,0 | 3.6 |
| CA121003-1607 | 20 | 1-1/4-18UNEF-2B | 36.1 | 125 | 16,0 | 3.6 |
| CA121003-1608 | 22 | 1-3/8-18UNEF-2B | 39.4 | 125 | 16,0 | 3.6 |
| CA121003-1609 | 24 | 1-1/2-18UNEF-2B | 42.6 | 140 | 16,0 | 4.4 |
| CA121003-1610 | 28 | 1-3/4-18UNEF-2B | 48.9 | 200 | 18,0 | 4.4 |
| CA121003-1611 | 32 | 2-18UNS-2B | 55.3 | 200 | 18,0 | 4.8 |
| CA121003-1612 | 36 | 2-1/4-16UN-2B | 61.6 | 200 | 18,0 | 4.8 |

ACCESSORIES

PROTECTIVE CAPS

with cord for receptacles with bayonet coupling. It mates with receptacles CA06COM-B and CA08COM-B

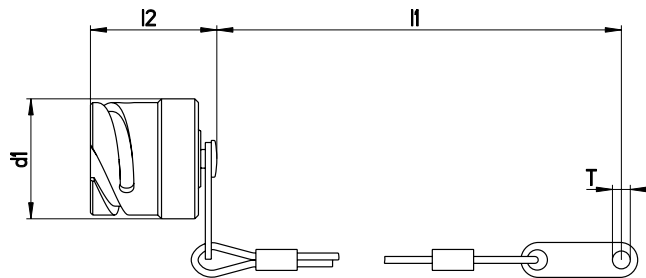

| Part No. | Shell size | d1 max | l1 ca | l2 max | T + 0,5 |
|---------------|------------|-----------|----------|-----------|------------|
| CA121004-1701 | 10SL | 20,7 | 100 | 29 | 4,3 |
| CA121004-1702 | 12S | 23,9 | 113 | 29 | 4,3 |
| CA121004-1703 | 14S | 27,1 | 113 | 29 | 4,3 |
| CA121004-1704 | 16S | 29,9 | 113 | 29 | 4,3 |
| CA121004-1705 | 16 | 29,9 | 127 | 37 | 4,3 |
| CA121004-1706 | 18 | 33,3 | 127 | 37 | 4,3 |
| CA121004-1707 | 20 | 36,7 | 140 | 37 | 4,7 |
| CA121004-1708 | 22 | 39,9 | 140 | 37 | 4,7 |
| CA121004-1709 | 24 | 43,4 | 140 | 37 | 4,7 |
| CA121004-1710 | 28 | 49,2 | 197 | 37 | 4,7 |
| CA121004-1711 | 32 | 55,9 | 197 | 37 | 5,5 |
| CA121004-1712 | 36 | 62,1 | 197 | 37 | 5,5 |

PROTECTIVE CAPS

with cord for receptacles with threaded coupling. It mates with receptacles CA06COM and CA08COM

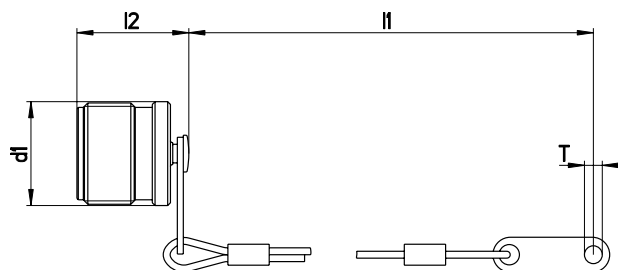

| Part No. | Shell size | A Thread | d1 max | l1 ca. | T + 0,4 |
|---------------|------------|-----------------|-----------|-----------|------------|
| CA121004-1601 | 10SL | 5/8-24UNEF-2A | 16,7 | 100 | 4,0 |
| CA121004-1602 | 12S | 3/4-20UNEF-2A | 19,8 | 100 | 4,0 |
| CA121004-1603 | 14S | 7/8-20UNEF-2A | 23,0 | 115 | 4,0 |
| CA121004-1604 | 16S, 16 | 1-20UNEF-2A | 26,2 | 115 | 4,0 |
| CA121004-1606 | 18 | 1-1/8-18UNEF-2A | 29,4 | 115 | 4,0 |
| CA121004-1607 | 20 | 1-1/4-18UNEF-2A | 32,5 | 125 | 4,8 |
| CA121004-1608 | 22 | 1-3/8-18UNEF-2A | 35,7 | 125 | 4,8 |
| CA121004-1609 | 24 | 1-1/2-18UNEF-2A | 38,9 | 140 | 4,8 |
| CA121004-1610 | 28 | 1-3/4-18UNEF-2A | 45,2 | 200 | 4,8 |
| CA121004-1611 | 32 | 2-18UNS-2A | 51,6 | 200 | 5,6 |
| CA121004-1612 | 36 | 2-1/4-16UN-2A | 57,9 | 200 | 5,6 |

ACCESSORIES

CABLE CLAMP WITHOUT BUSHING

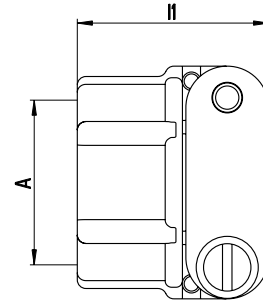
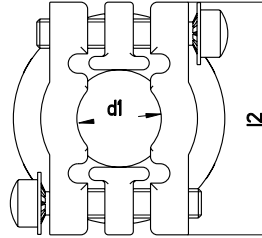

| Part No. | Shell size | A Thread | d1 max | l1 max | l2 max |
|--------------|------------|------------------|-----------|-----------|-----------|
| CA121051-325 | 10SL, 12S | 5/8-24UNEF-2B | 7,9 | 20,8 | 22,5 |
| CA121051-326 | 14S | 3/4-20UNEF-2B | 11,1 | 22,4 | 27,4 |
| CA121051-327 | 16S, 16 | 7/8-20UNEF-2B | 14,2 | 24,0 | 29,8 |
| CA121051-328 | 18 | 1-20UNEF-2B | 15,8 | 24,0 | 32,2 |
| CA121051-329 | 20, 22 | 1-3/16-18UNEF-2B | 19,0 | 24,0 | 37,4 |
| CA121051-330 | 24, 28 | 1-7/16-18UNEF-2B | 23,7 | 26,4 | 43,5 |
| CA121051-331 | 32 | 1-3/4-18UNS-2B | 31,8 | 28,0 | 51,7 |
| CA121051-332 | 36 | 2-18UNS-2B | 34,6 | 29,6 | 57,8 |

TELESCOPING BUSHING

The telescoping bushing is used together with above cable clamps CA121051-... or the other E type cable clamp connectors. It keeps oil, dirt or dust out of the endbell. Taping or wrapping or insulating of the wires feed through the clamp is eliminated since they are protected by the bushing. Combinations of bushings may be used to reduce cable entry diameters for improved sealing.

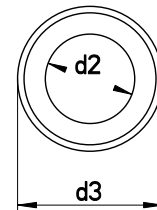
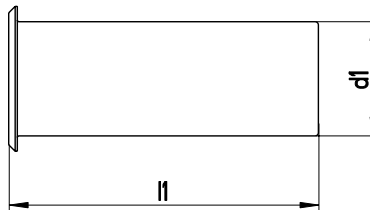

| Part No. | Shell size | d1 - 0,3 | d2 - 0,3 | d3 max | l1 max |
|--------------|------------|-------------|-------------|-----------|-----------|
| 012-8552-000 | 10SL, 12S | 8,0 | 6,6 | 9,9 | 70 |
| 012-8554-000 | 14S | 10,9 | 9,1 | 12,7 | 67 |
| 012-0218-000 | 16S, 16 | 14,0 | 11,1 | 19,0 | 64 |
| 012-0219-000 | 18 | 15,7 | 14,3 | 22,0 | 60 |
| 012-0220-000 | 20, 22 | 18,8 | 15,9 | 26,9 | 57 |
| 012-8555-000 | 24, 28 | 21,2 | 16,6 | 26,9 | 57 |
| 012-8556-000 | 24, 28 | 23,6 | 21,5 | 33,3 | 54 |
| 012-8557-000 | 32 | 26,5 | 21,5 | 33,3 | 54 |
| 012-8558-000 | 32 | 31,5 | 26,8 | 40,4 | 51 |
| 012-8558-000 | 36 | 31,5 | 26,8 | 40,4 | 51 |
| 012-0223-000 | 36 | 34,7 | 31,8 | 46,8 | 48 |

ACCESSORIES

GASKETS

These sealing gaskets made of neoprene are used with receptacles with flange for sealing between the shell and the flange of the receptacle

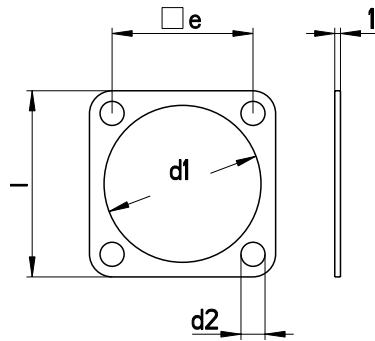

Gaskets for CA00COM-B / CA20COM-B (Rear panel mounting bayonet)

| Part No. | Shell size | d1 + 0,3 | d2 + 0,5 | l ± 0,5 | e ± 0,2 |
|--------------|------------|-------------|-------------|------------|------------|
| 075-8501-000 | 10SL | 18,2 | 4,2 | 25,4 | 18,2 |
| 075-8502-000 | 12S | 21,4 | 4,2 | 28,0 | 20,6 |
| 075-8503-000 | 14S | 24,6 | 4,2 | 30,0 | 23,0 |
| 075-8504-000 | 16S, 16 | 27,4 | 4,2 | 32,5 | 24,6 |
| 075-8505-000 | 18 | 30,8 | 4,2 | 35,0 | 27,0 |
| 075-8506-000 | 20 | 34,2 | 4,2 | 38,0 | 29,4 |
| 075-8507-000 | 22 | 37,4 | 4,2 | 41,0 | 31,8 |
| 075-8508-000 | 24 | 40,9 | 4,2 | 44,5 | 34,9 |
| 075-8509-000 | 28 | 46,7 | 5,1 | 50,8 | 39,7 |
| 075-8510-000 | 32 | 53,4 | 5,1 | 57,0 | 44,5 |
| 075-8511-000 | 36 | 59,6 | 5,1 | 63,5 | 49,2 |

Gaskets for CA00COM / CA02COM / CA02COM-B

| Part No. | Shell size | d1 + 1,0 | d2 + 0,5 | l ± 0,5 | e ± 0,2 |
|--------------|------------|-------------|-------------|------------|------------|
| 075-8512-000 | 10SL | 15,7 | 4,2 | 25,4 | 18,2 |
| 075-8513-000 | 12S | 18,9 | 4,2 | 28,0 | 20,6 |
| 075-8514-000 | 14S | 22,1 | 4,2 | 30,0 | 23,0 |
| 075-8515-000 | 16S, 16 | 25,3 | 4,2 | 32,5 | 24,6 |
| 075-8516-000 | 18 | 28,4 | 4,2 | 35,0 | 27,0 |
| 075-8517-000 | 20 | 31,6 | 4,2 | 38,0 | 29,4 |
| 075-8518-000 | 22 | 34,8 | 4,2 | 41,0 | 31,8 |
| 075-8519-000 | 24 | 38,0 | 4,2 | 44,5 | 34,9 |
| 075-8520-000 | 28 | 44,3 | 5,1 | 50,8 | 39,7 |
| 075-8521-000 | 32 | 50,7 | 5,1 | 57,0 | 44,5 |
| 075-8522-000 | 36 | 57,0 | 5,1 | 63,5 | 49,2 |

ACCESSORIES

CONTACTS

Standard contacts and contacts with reduced termination diameter

SIZE 15S/16S, 15/16, 25/12, 60/100/8, 160/4, 500/0

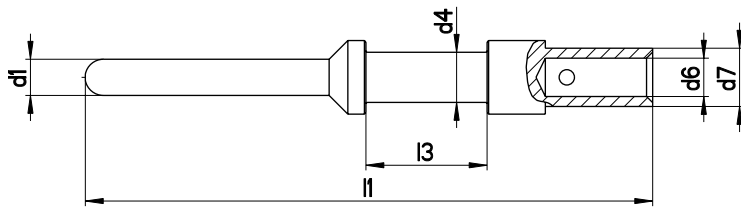

SIZE 10/20

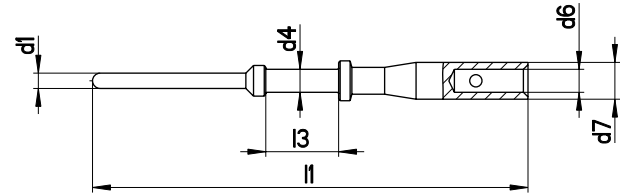

Pin contacts Finish: A36–5 μ m silver plated and passivated

| Contact size | Wire size | | Part no. | d1 -0,05 | d4 | d6 | d7 | l1 $\pm 0,15$ | l3 $\pm 0,5$ | Color code |
|--------------|-----------------|-------|--------------|-------------|-------|------|-------|------------------|-----------------|------------|
| | mm ² | AWG | | | | | | | | |
| 10/20 | 0,5–1,0 | 20/18 | 030-8585-000 | 1,04 | 1,50 | 1,50 | 2,40 | 28,4 | 4,75 | – |
| | 0,2–0,4 | 26/22 | 030-8585-010 | 1,04 | 1,50 | 0,90 | 2,40 | 28,4 | 4,75 | blue |
| 15S/16S | 0,75–1,5 | 18/16 | 030-8586-000 | 1,60 | 1,75 | 1,75 | 2,75 | 27,4 | 3,85 | – |
| | 0,3–0,6 | 22/20 | 330-8744-000 | 1,60 | 1,75 | 1,20 | 2,75 | 27,4 | 3,85 | red |
| | 0,14–0,38 | 22/26 | 030-8586-010 | 1,60 | 1,75 | 0,90 | 2,75 | 27,4 | 3,85 | blue |
| 15/16 | 0,75–1,5 | 18/16 | 030-8587-000 | 1,60 | 1,75 | 1,75 | 2,75 | 31,4 | 7,90 | – |
| | 0,3–0,6 | 22/20 | 330-8659-000 | 1,60 | 1,75 | 1,20 | 2,75 | 31,4 | 7,90 | red |
| | 0,14–0,38 | 22/26 | 030-8587-030 | 1,60 | 1,75 | 0,90 | 2,75 | 31,4 | 7,90 | blue |
| 25/12 | 2,0–3,0 | 14/12 | 030-8588-000 | 2,40 | 3,30 | 2,50 | 3,80 | 37,0 | 7,90 | – |
| | 0,75–1,5 | 18/16 | 030-8588-010 | 2,40 | 3,30 | 1,75 | 3,40 | 37,0 | 7,90 | black |
| | 4,0 | – | 030-8588-054 | 2,40 | 3,30 | 2,80 | 3,80 | 37,0 | 7,90 | – |
| 60/100/8 | – | 8 | 030-8612-000 | 3,60 | 6,25 | 4,55 | 6,80 | 39,6 | 6,35 | – |
| | 6,0 | 10 | 030-8589-000 | 3,60 | 6,25 | 3,50 | 6,80 | 39,6 | 6,35 | yellow |
| | 10,0 | – | 030-8590-000 | 3,60 | 6,25 | 4,80 | 6,80 | 39,6 | 6,35 | – |
| | 2,0–3,0 | 14/12 | 030-8612-010 | 3,60 | 6,25 | 2,50 | 6,80 | 39,6 | 6,35 | green |
| 160/4 | – | 4 | 030-8613-000 | 5,75 | 9,55 | 7,10 | 9,55 | 39,6 | 6,35 | – |
| | 16,0 | – | 030-8591-000 | 5,75 | 9,55 | 6,20 | 9,55 | 39,6 | 6,35 | – |
| | 10,0 | – | 030-8591-020 | 5,75 | 9,55 | 4,80 | 9,55 | 39,6 | 6,35 | – |
| | – | 6 | 030-8613-010 | 5,75 | 9,55 | 5,70 | 9,55 | 39,6 | 6,35 | brown |
| 500/0 | – | 0 | 030-8614-000 | 9,10 | 13,55 | 11,5 | 14,35 | 41,0 | 6,35 | – |
| | 50,0 | – | 030-8592-000 | 9,10 | 13,55 | 10,7 | 14,35 | 41,0 | 6,35 | – |
| | 25,0 | 4 | 030-8614-010 | 9,10 | 13,55 | 7,60 | 14,35 | 41,0 | 6,35 | white |
| | 35,0 | 2 | 030-8614-020 | 9,10 | 13,55 | 9,10 | 14,35 | 41,0 | 6,35 | grey |
| | 16,0 | – | 030-8614-030 | 9,10 | 13,55 | 6,20 | 14,35 | 41,0 | 6,35 | – |

ACCESSORIES

CONTACTS

Standard contacts and contacts with reduced termination diameter

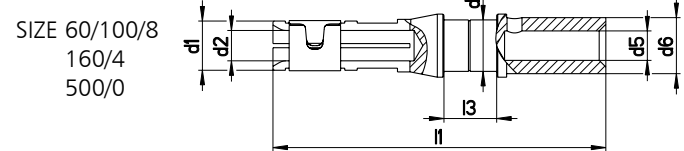
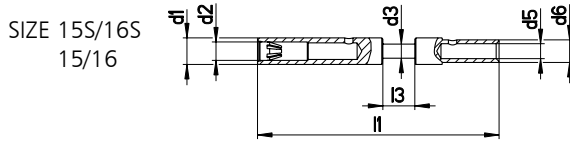
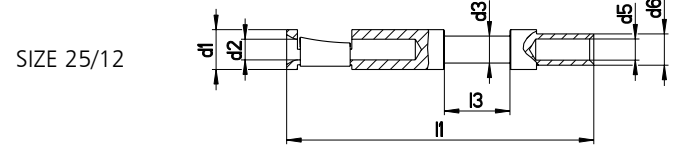
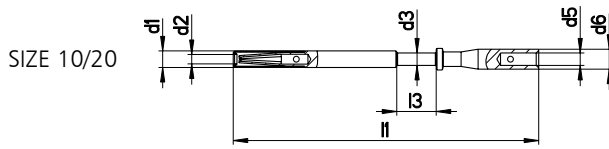

Socket contacts Finish: A36–5 μ m silver plated and passivated

| Contact size | Wire size | | Part no. | d1 | d2 + 0,05 | d3 | d5 | d6 | l1 $\pm 0,2$ | l3 $\pm 0,1$ | Color code |
|--------------|-----------------|-------|--------------|------|--------------|-------|------|-------|-----------------|-----------------|------------|
| | mm ² | AWG | | | | | | | | | |
| 10/20 | 0,5–1,0 | 20/18 | 031-8554-000 | 2,0 | 1,07 | 1,5 | 1,5 | 2,4 | $36,8 \pm 0,3$ | 4,75 | – |
| | 0,2–0,4 | 26/22 | 031-8554-010 | 2,0 | 1,07 | 1,5 | 0,9 | 2,4 | $36,8 \pm 0,3$ | 4,75 | blue |
| 15S/16S | 0,75–1,5 | 18/16 | 031-8555-110 | 3,2 | 1,65 | 1,75 | 1,75 | 2,75 | 29,1 | 3,9 | – |
| | 0,3–0,6 | 22/20 | 031-8688-110 | 3,2 | 1,65 | 1,75 | 1,2 | 2,75 | 29,1 | 3,9 | red |
| | 0,14–0,38 | 22/26 | 031-8555-130 | 3,2 | 1,65 | 1,75 | 0,9 | 2,75 | 29,1 | 3,9 | blue |
| 15/16 | 0,75–1,5 | 18/16 | 031-8556-110 | 3,2 | 1,65 | 1,75 | 1,75 | 2,75 | 37,8 | 7,9 | – |
| | 0,3–0,6 | 22/20 | 031-8639-120 | 3,2 | 1,65 | 1,75 | 1,2 | 2,75 | 37,8 | 7,9 | red |
| | 0,14–0,38 | 22/26 | 031-8556-130 | 3,2 | 1,65 | 1,75 | 0,9 | 2,75 | 37,8 | 7,9 | blue |
| 25/12 | 2,0–3,0 | 14/12 | 031-8557-000 | 4,8 | 2,45 | 3,3 | 2,5 | 3,8 | 37,0 | 7,9 | – |
| | 0,75–1,5 | 18/16 | 031-8557-020 | 4,8 | 2,45 | 3,3 | 1,75 | 3,4 | 37,0 | 7,9 | black |
| | 4,0 | – | 031-8557-010 | 4,8 | 2,45 | 3,3 | 2,8 | 3,8 | 37,0 | 7,9 | – |
| | 0,3–0,6 | 22/20 | 031-8557-040 | 4,8 | 2,45 | 3,3 | 1,2 | 2,75 | 37,0 | 7,9 | – |
| 60/100/8 | – | 8 | 031-8519-000 | 6,5 | 3,65 | 6,25 | 4,55 | 6,8 | 40,1 | 6,35 | – |
| | 6,0 | 10 | 031-8558-000 | 6,5 | 3,65 | 6,25 | 3,5 | 6,8 | 40,1 | 6,35 | yellow |
| | 10,0 | – | 031-8559-000 | 6,5 | 3,65 | 6,25 | 4,8 | 6,8 | 40,1 | 6,35 | – |
| | 2,0–3,0 | 14/12 | 031-8519-010 | 6,5 | 3,65 | 6,25 | 2,5 | 6,8 | 40,1 | 6,35 | green |
| 160/4 | – | 4 | 031-8520-000 | 8,6 | 5,8 | 9,55 | 7,1 | 9,55 | 40,1 | 6,35 | – |
| | 16,0 | – | 031-8560-000 | 8,6 | 5,8 | 9,55 | 6,2 | 9,55 | 40,1 | 6,35 | – |
| | 10,0 | – | 031-8560-020 | 8,6 | 5,8 | 9,55 | 4,8 | 9,55 | 40,1 | 6,35 | – |
| | – | 6 | 031-8520-010 | 8,6 | 5,8 | 9,55 | 5,7 | 9,55 | 40,1 | 6,35 | brown |
| 500/0 | – | 0 | 031-8521-000 | 13,2 | 9,15 | 13,55 | 11,5 | 14,35 | 41,6 | 6,35 | – |
| | 50,0 | – | 031-8561-000 | 13,2 | 9,15 | 13,55 | 10,7 | 14,35 | 41,6 | 6,35 | – |
| | 25,0 | 4 | 031-8521-010 | 13,2 | 9,15 | 13,55 | 7,6 | 14,35 | 41,6 | 6,35 | white |
| | 35,0 | 2 | 031-8521-020 | 13,2 | 9,15 | 13,55 | 9,1 | 14,35 | 41,6 | 6,35 | grey |
| | 16,0 | – | 031-8521-030 | 13,2 | 9,15 | 13,55 | 6,2 | 14,35 | 41,6 | 6,35 | – |

Remark:

For Socket contact installation the following guiding pins are essential:

| Contact size | Part number |
|------------------------------|-------------|
| guide pin # 15/16 and 15S/16 | 27977-16T50 |
| guide pin # 12/25 | 27977-12T8 |

ACCESSORIES

TOOLING FOR CONTACT CRIMPING AND INSTALLATION

HAND CRIMP TOOL M22520-1-01 PART NUMBER 995-0001-585



| Contact size | Wire size | | Crimp Locator | Order Reference |
|----------------|-----------------|-------|---------------|-----------------|
| | mm ² | AWG | | |
| 10 | 0,5–1,0 | 20/18 | 600325 | 121586-0034 |
| | 0,2–0,4 | 26/22 | | |
| Pin 15S/16S | 0,75–1,5 | 18/16 | TH 452 | 995-0002-052 |
| | 0,3–0,6 | 22/20 | | |
| | 0,14–0,38 | 22/26 | | |
| Socket 15S/S16 | 0,75–1,5 | 18/16 | TH 452 | 995-0002-052 |
| | 0,3–0,6 | 22/20 | | |
| | 0,14–0,38 | 22/26 | | |
| 15/16 | 0,75–1,5 | 18/16 | TH 452 | 995-0002-052 |
| | 0,3–0,6 | 22/20 | | |
| | 0,14–0,38 | 22/26 | | |
| 25/12 | 2,0–3,0 | 14/12 | TH 452 | 995-0002-052 |
| | 0,75–1,5 | 18/16 | | |
| | 4,0 | – | | |

HYDRAULIC HANDCRIMP TOOL HPW400U-ITT PART NUMBER 121586-5257



| Contact size | Wire size | | Specifics |
|--------------|-----------------|-------|--|
| | mm ² | AWG | |
| 60/100/8 | 6,0 | 8 | The hydraulic handcrimp tool HPW400U-ITT is delivered without crimp dies. Please order your specific crimp dies separately, on page 44 |
| | 2,0–3,0 | 10 | |
| | – | 14/12 | |
| 160/4 | 16,0 | 4 | The hydraulic handcrimp tool HPW400U-ITT is delivered without crimp dies. Please order your specific crimp dies separately, on page 44 |
| | 10,0 | 6 | |
| | – | – | |
| 500/0 | – | 0 | The hydraulic handcrimp tool HPW400U-ITT is delivered without crimp dies. Please order your specific crimp dies separately, on page 44 |
| | 50,0 | – | |
| | 25,0 | 4 | |
| | 35,0 | 2 | |
| | 16,0 | – | |

ELECTRO HYDRAULIC TOOL HP700EL-ITT PART NUMBER 121586-5279



| Contact size | Wire size | | Specifics |
|--------------|-----------------|-------|---|
| | mm ² | AWG | |
| 60/100/8 | 6,0 | 8 | The electro-hydraulic tool HP700EL-ITT is delivered with an H-crimp head (table mount), foot pedal and hand control. Please order crimp dies as well as switch mode power supply or lithium-ion battery separately - details below. |
| | 2,0–3,0 | 10 | |
| | – | 14/12 | |
| 160/4 | 16,0 | 4 | The electro-hydraulic tool HP700EL-ITT is delivered with an H-crimp head (table mount), foot pedal and hand control. Please order crimp dies as well as switch mode power supply or lithium-ion battery separately - details below. |
| | 10,0 | 6 | |
| | – | – | |
| 500/0 | – | 0 | The electro-hydraulic tool HP700EL-ITT is delivered with an H-crimp head (table mount), foot pedal and hand control. Please order crimp dies as well as switch mode power supply or lithium-ion battery separately - details below. |
| | 50,0 | – | |
| | 25,0 | 4 | |
| | 35,0 | 2 | |
| | 16,0 | – | |

ACCESSORIES FOR ELECTR HYDRAULIC CRIMP TOOL HP700EL-ITT PART NUMBER 121586-5279

| Description | Marking | Part Number |
|---|----------|-------------|
| Switch mode power supply | SNT4-ITT | 121586-5280 |
| Lithium Ion Battery 18V 3A with recharger | LGA4-ITT | 121586-5281 |

ACCESSORIES

TOOLING FOR CONTACT INSERTION AND EXTRACTION

INSERTION AND EXTRACTION TOOLS



Insertion Tools

| Type | CIT 20 | CIT 16 | CIT12 | CIT 8 | CIT 4 | CIT 0 |
|----------|-------------|-------------|-------------|-------------|-------------|-------------|
| Part No. | 121086-3009 | 121086-3008 | 121086-3007 | 121086-0095 | 121086-0094 | 121086-0093 |

Insertion Pliers

| Type | CIT-F80-20 | CIT-F80-16 | CIT-F80-12 |
|----------|-------------|-------------|-------------|
| Part No. | 121086-0098 | 121086-0097 | 121086-0096 |

Extraction Tools

| Type | CET-F80-20 | CET-F80-16 | CET-F80-12 | CET-8 | CET-4 | CET-0 |
|----------|-------------|-------------|-------------|-------------|-------------|-------------|
| Part No. | 121086-0082 | 121086-0081 | 121086-0080 | 121086-0079 | 121086-0078 | 121086-0077 |

CRIMP DIES FOR MS/CA, VG95234



| Contact size | Wire size | | Hex. Diameter | Stamped Label | Part Number |
|--------------|-----------------|-----|---------------|---------------|-------------|
| | mm ² | AWG | | | |
| 60/100/8 | 6/10 | 8 | 5,20 | 01 | 121586-5231 |
| 160/4 | 16 | 4 | 7,25 | 02 | 121586-5230 |
| 500/0 | 50,0 | 0 | 11,40 | 03 | 121586-5229 |

Locator for MS/CA, part number 121586-5232

Notes:

1. For large series production, semi-automatic crimp machine Type HACS-IV-MSXX upon request
2. For insertion and extraction of the contacts and for connector assembly see "Assembly instructions SAE-AS50151/VG95234
3. Standard contacts acc. to SAE-AS50151/VG95234

PRODUCT SAFETY INFORMATION

1. MATERIAL CONTENT AND PHYSICAL FORM

Electrical connectors do not usually contain hazardous materials. They contain conducting and non-conducting materials and can be divided into two groups.

a) Printed circuit types and low cost audio types which employ all plastic insulators and casings.

b) Rugged, Fire Barrier and High Reliability types with metal casings and either natural rubber, synthetic rubber, plastic or glass insulating materials. Contact materials vary with type of connector and also application and are usually manufactured from either: Copper, copper alloys, nickel, alumel, chromel or steel. In special applications, other alloys may be specified.

CAUTION

2. FIRE CHARACTERISTICS AND ELECTRIC SHOCK HAZARD

There is no fire hazard when the connector is correctly wired and used within the specified parameters.

Incorrect wiring or assembly of the connector or careless use of metal tools or conductive fluids, or transit damage to any of the component parts may cause electric shock or burns. Live circuits must not be broken by separating mated connectors as this may cause arcing, ionization and burning. Heat dissipation is greater at maximum resistance in a circuit. Hot spots may occur when resistance is raised locally by damage, e.g. cracked or deformed contacts, broken strands of wire. Local overheating may also result from the use of the incorrect application tools or from poor quality soldering or slack screw terminals. Overheating may occur if the ratings in the product Data Sheet/Catalog are exceeded and can cause breakdown of insulation and hence electric shock. If heating is allowed to continue it intensifies by further increasing the local resistance through loss of temper of spring contacts, formation of oxide film on contacts and wires and leakage currents through carbonization of insulation and tracking paths. Fire can then result in the presence of combustible materials and this may release noxious fumes. Overheating may not be visually apparent. Burns may result from touching overheated components.

3. HANDLING

Care must be taken to avoid damage to any component parts of electrical connectors during installation and use. Although there are normally no sharp edges, care must be taken when handling certain components to avoid injury to fingers.

Electrical connectors may be damaged in transit to the customers, and damage may result in creation of hazards. Products should therefore be examined prior to installation/use and rejected if found to be damaged.

4. DISPOSAL

Incineration of certain materials may release noxious or even toxic fumes.

5. APPLICATION

Connectors with exposed contacts should not be selected for use on the current supply side of an electrical circuit, because an electric shock could result from touching exposed contacts on an unmated connector. Voltages in excess of 30V ac or 42.5V DC are potentially hazardous and care should be taken to ensure that such voltages cannot be transmitted in any way to exposed metal parts of the connector body. The connector and wiring should be checked, before making live, to have no damage to metal parts or insulators, no solder blobs, loose strands, conducting lubricants, swarf, or any other undesired conducting particles. Circuit resistance and continuity check should be made to make certain that there are no high resistance joints or spurious conducting paths. Always use the correct application tools as specified in the Data Sheet/Catalog. Do not permit untrained personnel to wire, assemble or tamper with connectors. For operation voltage please see appropriate national regulations.

IMPORTANT GENERAL INFORMATION

(i) **Air and creepage paths/Operating voltage.** The admissible operating voltages depend on the individual applications and the valid national and other applicable safety regulations. For this reason the air and creepage path data are only reference values. Observe reduction of air and creepage paths due to PC board and/or harnessing.

(ii) Temperature

All information given are temperature limits. The operation temperature depends on the individual application.

(iii) Other important information

Cannon continuously endeavors to improve their products. Therefore, Cannon products may deviate from the description, technical data and shape as shown in this catalog and data sheets.

ITT Cannon manufactures the highest quality products available in the marketplace; however these products are intended to be used in accordance with the specifications

in this publication. Any use or application that deviates from the stated operating specifications is not recommended and may be unsafe. No information and data contained in this publication shall be construed to create any liability on the part of Cannon. Any new issue of this publication shall automatically invalidate and supersede any and all previous issues.

cannon

Amazing things
happen when great
things connect



Connect with your ITT Cannon representative today
or visit us at www.ittcannon.com

Connect with the experts

ITT's Cannon brand is a world leader in the design and manufacture of highly engineered connector solutions for multiple end markets.



ENGINEERED FOR LIFE

North America

56 Technology Drive
Irvine, CA 92618
Phone: +1.800.854.3028

Europe

Italy
Corso Europa 41/43
20020 Lainate (MI), Italy
Phone: +39.02938721

Germany
Cannonstrasse 1
71384 Weinstadt, Germany
Phone: +49.7151.699.0

Asia

Tuopandun Industrial Area, Jinda Cheng,
Xiner Village, Shajing Town, Boan District,
Shenzhen City, Guangdong Province, China 518215
Phone: +86.755.2726.7888

X-ON Electronics

Largest Supplier of Electrical and Electronic Components

Click to view similar products for [Circular MIL Spec Connector](#) category:

Click to view products by [ITT](#) manufacturer:

Other Similar products are found below :

[89075GULPR](#) [0025-262-542](#) [0025-264-3014](#) [58-570121-04S](#) [0134-213-1208](#) [0134-213-2209](#) [0025-258-000](#) [60-042022-07P](#) [60-042022-19P](#)
[60-042022-23P](#) [60-042217-10P](#) [0114-201-1278](#) [012-0467-000](#) [602GB06EG24-61SN](#) [0134-201-1207](#) [0134-213-1006](#) [6104-207-2302](#) [6104-](#)
[208-1902](#) [61-168211-04P](#) [61-168617-10P](#) [6131-202-19149P](#) [6131-204-21149P](#) [6131-208-13149P](#) [6131-209-17149P](#) [6131-210-11149P](#) [6131-](#)
[211-19149P](#) [6131-216-19149P](#) [6131-259-21149P](#) [6131-259-23149P](#) [6131-265-17149P](#) [6131-265-19149P](#) [CS3100A18-1P-472](#) [CS3100A-36-](#)
[77P](#) [CS3101A-16-55P](#) [CS3102A-10SL-55P](#) [CS3102A-14S-58P](#) [CS3102A-32-17P](#) [CS3102A32-25S](#) [CS3102C18-4P-472](#)
[CS3106A10SL3S004](#) [CS3106A-18-73S](#) [CS3108A-14S-52S](#) [CS3108A-28-51S](#) [6162-233-1277](#) [6162-324-1231](#) [M243082296Z](#)
[M2884010AC1S1](#) [CT0-24-10SC](#) [CT0M20-7PCAU](#) [M28840/17AC1G3](#)