

## Final datasheet

**TRENCHSTOP™ IGBT 7 PR7 Reverse Conducting IGBT for boost PFC stage with improved EMI characteristics offering the best-in-class performance for high power and high switching frequency applications**

### Features

- $V_{CE} = 670\text{ V}$
- $I_C = 50\text{ A}$
- Pin-to-pin creepage distance > 4.8 mm
- Pin-to-pin clearance distance > 3.4 mm
- Optimized monolithic diode for PFC applications
- Improved EMI behavior with lower  $dv/dt$
- Very low  $V_{CEsat} = 1.4\text{ V}$  (typ.) at  $25^\circ\text{C}$
- Stable temperature behavior
- Low temperature dependence of  $V_{CEsat}$  and  $E_{sw}$
- 2 kV ESD HBM compliant
- Easy parallel switching capability based on positive temperature coefficient of  $V_{CEsat}$
- Product spectrum and PSpice Models: <http://www.infineon.com/igbt/>

### Potential applications

- Residential Aircon / Commercial Aircon
- Residential HVAC / Commercial HVAC

### Product validation

- Qualified for industrial applications according to the relevant tests of JEDEC47/20/22

### Description

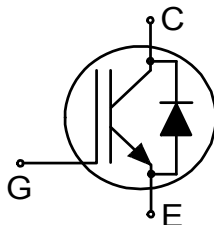

Type	Package	Marking
IKWH50N67PR7	PG-TO247-3-U04	H50EPR7

## Table of contents

	<b>Description</b> .....	1
	<b>Features</b> .....	1
	<b>Potential applications</b> .....	1
	<b>Product validation</b> .....	1
	<b>Table of contents</b> .....	2
<b>1</b>	<b>Package</b> .....	3
<b>2</b>	<b>IGBT</b> .....	3
<b>3</b>	<b>Diode</b> .....	5
<b>4</b>	<b>Characteristics diagrams</b> .....	6
<b>5</b>	<b>Package outlines</b> .....	11
<b>6</b>	<b>Testing conditions</b> .....	12
	<b>Revision history</b> .....	13
	<b>Disclaimer</b> .....	14

## 1 Package

## 1 Package

Table 1 Characteristic values

Parameter	Symbol	Note or test condition	Values			Unit
			Min.	Typ.	Max.	
Internal emitter inductance measured 5 mm (0.197 in.) from case	$L_E$			13		nH
Storage temperature	$T_{stg}$		-55		150	°C
Soldering temperature	$T_{sold}$	wave soldering 1.6 mm (0.063 in.) from case for 10 s			260	°C
Mounting torque	$M$	M3 screw, Maximum of mounting processes: 3			0.6	Nm
Thermal resistance, junction-ambient	$R_{th(j-a)}$				40	K/W
IGBT thermal resistance, junction-case	$R_{th(j-c)}$			0.61	0.79	K/W

## 2 IGBT

Table 2 Maximum rated values

Parameter	Symbol	Note or test condition	Values	Unit	
Collector-emitter voltage	$V_{CE}$	$T_{vj} \geq 25\text{ °C}$	670	V	
DC collector current, limited by $T_{vjmax}$	$I_C$		$T_c = 25\text{ °C}$	105	A
			$T_c = 100\text{ °C}$	65	
Pulsed collector current, $t_p$ limited by $T_{vjmax}$	$I_{Cpulse}$		150	A	
Turn-off safe operating area		$V_{CE} \leq 670\text{ V}, T_{vj} \leq 175\text{ °C}$	150	A	
Gate-emitter voltage	$V_{GE}$		$\pm 20$	V	
Transient gate-emitter voltage	$V_{GE}$	$t_p \leq 0.5\text{ }\mu\text{s}, D < 0.001$	$\pm 30$	V	
Power dissipation	$P_{tot}$		$T_c = 25\text{ °C}$	246	W
			$T_c = 100\text{ °C}$	123	

Table 3 Characteristic values

Parameter	Symbol	Note or test condition	Values			Unit
			Min.	Typ.	Max.	
Collector-emitter saturation voltage	$V_{CEsat}$	$I_C = 50\text{ A}, V_{GE} = 15\text{ V}$	$T_{vj} = 25\text{ °C}$	1.4	1.75	V
			$T_{vj} = 175\text{ °C}$	1.7		

(table continues...)

Table 3 (continued) Characteristic values

Parameter	Symbol	Note or test condition	Values			Unit
			Min.	Typ.	Max.	
Gate-emitter threshold voltage	$V_{GEth}$	$I_C = 0.285 \text{ mA}, V_{CE} = V_{GE}$	3.2	3.95	4.8	V
Zero gate-voltage collector current	$I_{CES}$	$V_{CE} = 670 \text{ V}, V_{GE} = 0 \text{ V}$	$T_{vj} = 25 \text{ °C}$		40	mA
			$T_{vj} = 175 \text{ °C}$		0.5	mA
Gate-emitter leakage current	$I_{GES}$	$V_{CE} = 0 \text{ V}, V_{GE} = 20 \text{ V}$			100	nA
Transconductance	$g_{fs}$	$I_C = 50 \text{ A}, V_{CE} = 20 \text{ V}$		77.6		S
Input capacitance	$C_{ies}$	$V_{CE} = 25 \text{ V}, V_{GE} = 0 \text{ V}, f = 100 \text{ kHz}$		2846		pF
Output capacitance	$C_{oes}$	$V_{CE} = 25 \text{ V}, V_{GE} = 0 \text{ V}, f = 100 \text{ kHz}$		36.4		pF
Reverse transfer capacitance	$C_{res}$	$V_{CE} = 25 \text{ V}, V_{GE} = 0 \text{ V}, f = 100 \text{ kHz}$		14.2		pF
Gate charge	$Q_G$	$V_{CC} = 520 \text{ V}, I_C = 50 \text{ A}, V_{GE} = 15 \text{ V}$		127		nC
Turn-on delay time	$t_{d(on)}$	$V_{CC} = 400 \text{ V}, V_{GE} = 0/15 \text{ V}, R_{G(on)} = 9.8 \text{ } \Omega, R_{G(off)} = 9.8 \text{ } \Omega$	$T_{vj} = 25 \text{ °C}, I_C = 50 \text{ A}$		18	ns
			$T_{vj} = 175 \text{ °C}, I_C = 50 \text{ A}$		18	
Rise time (inductive load)	$t_r$	$V_{CC} = 400 \text{ V}, V_{GE} = 0/15 \text{ V}, R_{G(on)} = 9.8 \text{ } \Omega, R_{G(off)} = 9.8 \text{ } \Omega$	$T_{vj} = 25 \text{ °C}, I_C = 50 \text{ A}$		19	ns
			$T_{vj} = 175 \text{ °C}, I_C = 50 \text{ A}$		17	
Turn-off delay time	$t_{d(off)}$	$V_{CC} = 400 \text{ V}, V_{GE} = 0/15 \text{ V}, R_{G(on)} = 9.8 \text{ } \Omega, R_{G(off)} = 9.8 \text{ } \Omega$	$T_{vj} = 25 \text{ °C}, I_C = 50 \text{ A}$		182	ns
			$T_{vj} = 175 \text{ °C}, I_C = 50 \text{ A}$		206	
Fall time (inductive load)	$t_f$	$V_{CC} = 400 \text{ V}, V_{GE} = 0/15 \text{ V}, R_{G(on)} = 9.8 \text{ } \Omega, R_{G(off)} = 9.8 \text{ } \Omega$	$T_{vj} = 25 \text{ °C}, I_C = 50 \text{ A}$		32	ns
			$T_{vj} = 175 \text{ °C}, I_C = 50 \text{ A}$		46	
Turn-on energy	$E_{on}$	$V_{CC} = 400 \text{ V}, V_{GE} = 0/15 \text{ V}, R_{G(on)} = 9.8 \text{ } \Omega, R_{G(off)} = 9.8 \text{ } \Omega$	$T_{vj} = 25 \text{ °C}, I_C = 50 \text{ A}$		0.98	mJ
			$T_{vj} = 175 \text{ °C}, I_C = 50 \text{ A}$		1.57	
Turn-off energy	$E_{off}$	$V_{CC} = 400 \text{ V}, V_{GE} = 0/15 \text{ V}, R_{G(on)} = 9.8 \text{ } \Omega, R_{G(off)} = 9.8 \text{ } \Omega$	$T_{vj} = 25 \text{ °C}, I_C = 50 \text{ A}$		0.56	mJ
			$T_{vj} = 175 \text{ °C}, I_C = 50 \text{ A}$		0.81	

(table continues...)

Table 3 (continued) Characteristic values

Parameter	Symbol	Note or test condition	Values			Unit	
			Min.	Typ.	Max.		
Total switching energy	$E_{ts}$	$V_{CC} = 400\text{ V}$ , $V_{GE} = 0/15\text{ V}$ , $R_{G(on)} = 9.8\ \Omega$ , $R_{G(off)} = 9.8\ \Omega$	$T_{vj} = 25\text{ }^\circ\text{C}$ , $I_C = 50\text{ A}$		1.54		mJ
			$T_{vj} = 175\text{ }^\circ\text{C}$ , $I_C = 50\text{ A}$		2.38		
Operating junction temperature	$T_{vj}$		-40		175	$^\circ\text{C}$	

### 3 Diode

Table 4 Maximum rated values

Parameter	Symbol	Note or test condition	Values	Unit
Repetitive peak reverse voltage	$V_{RRM}$	$T_{vj} \geq 25\text{ }^\circ\text{C}$	670	V
Diode pulsed current, $t_p$ limited by $T_{vjmax}$	$I_{Fpulse}$		5	A

Table 5 Characteristic values

Parameter	Symbol	Note or test condition	Values			Unit
			Min.	Typ.	Max.	
Operating junction temperature	$T_{vj}$		-40		175	$^\circ\text{C}$

**Note:** For optimum lifetime and reliability, Infineon recommends operating conditions that do not exceed 80% of the maximum ratings stated in this datasheet.

Electrical Characteristic, at  $T_{vj} = 25\text{ }^\circ\text{C}$ , unless otherwise specified.

Dynamic test circuit, parasitic inductance  $L_\sigma = 30\text{ nH}$ , parasitic capacitor  $C_\sigma = 23\text{ pF}$  from Fig. C.

2nd device for EC7 Diode = IDWD50E65E7

## 4 Characteristics diagrams

### Power dissipation as a function of case temperature

$P_{tot} = f(T_c)$   
 $T_{vj} \leq 175\text{ °C}$

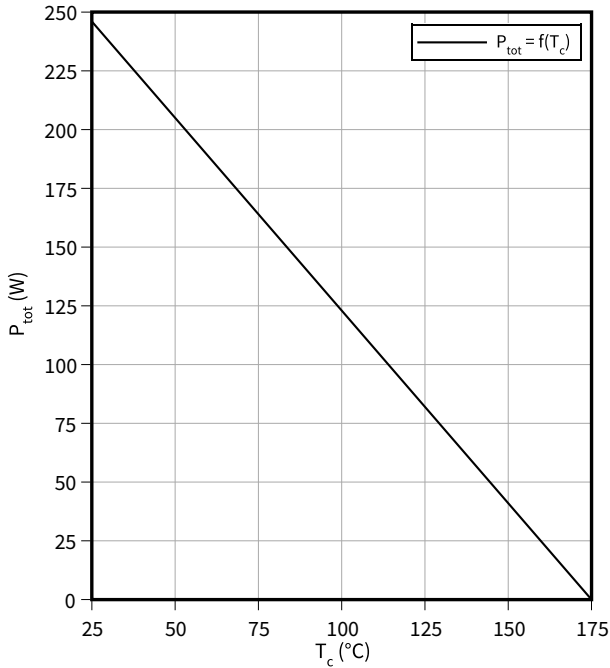

### Collector current as a function of case temperature

$I_c = f(T_c)$   
 $T_{vj} \leq 175\text{ °C}, V_{GE} \geq 15\text{ V}$

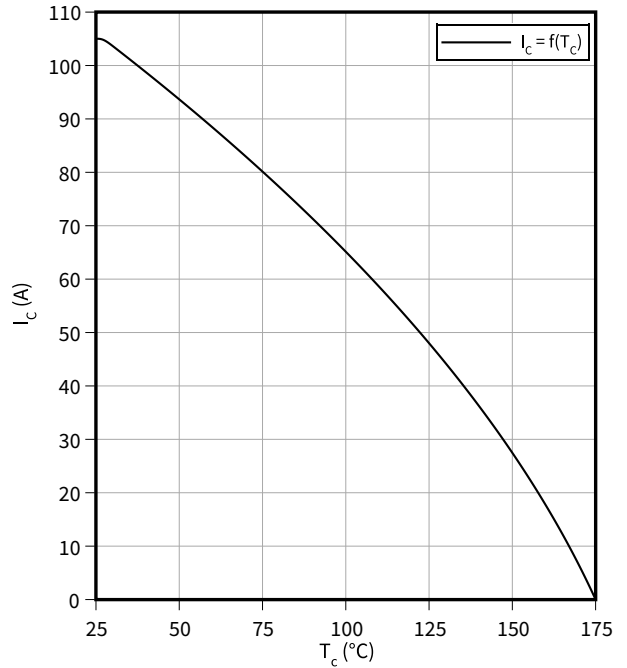

### Typical output characteristic

$I_c = f(V_{CE})$   
 $T_{vj} = 25\text{ °C}$

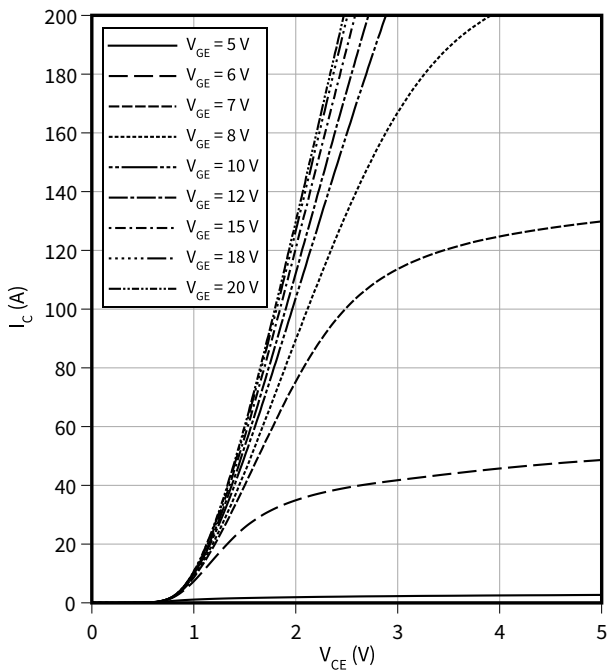

### Typical output characteristic

$I_c = f(V_{CE})$   
 $T_{vj} = 175\text{ °C}$

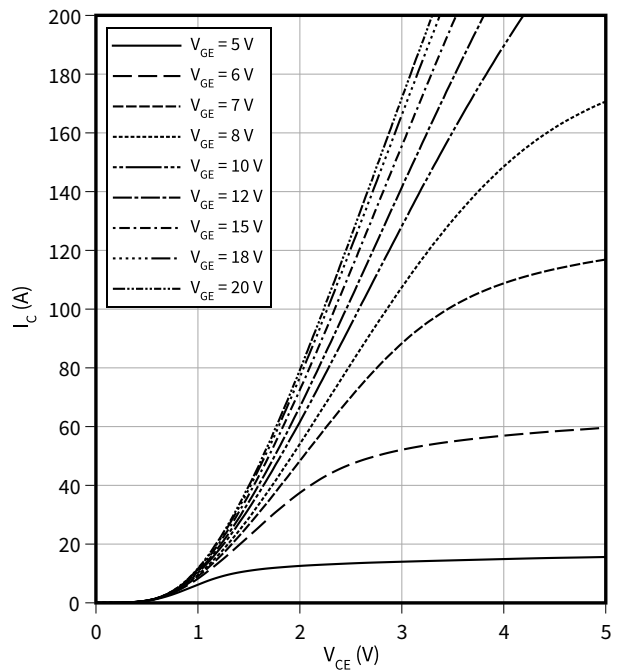

**4 Characteristics diagrams**

**Typical transfer characteristic**

$I_C = f(V_{GE})$

$V_{CE} = 20\text{ V}$

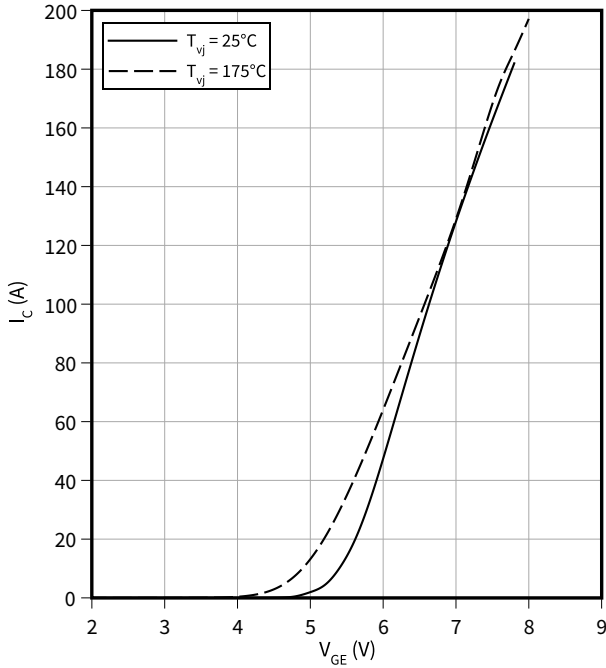

**Typical collector-emitter saturation voltage as a function of junction temperature**

$V_{CEsat} = f(T_{vj})$

$V_{GE} = 15\text{ V}$

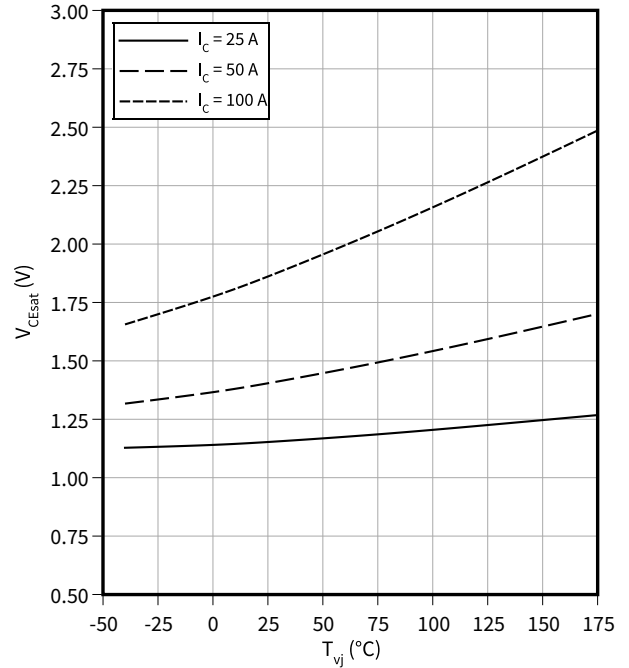

**Gate-emitter threshold voltage as a function of junction temperature**

$V_{GEth} = f(T_{vj})$

$I_C = 0.285\text{ mA}$

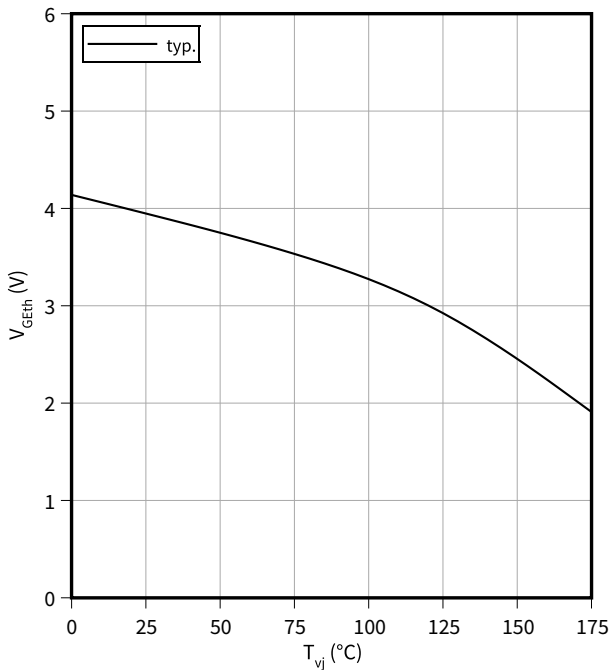

**Typical switching times as a function of collector current**

$t = f(I_C)$

$V_{CC} = 400\text{ V}, T_{vj} = 175^\circ\text{ C}, V_{GE} = 0/15\text{ V}, R_G = 9.8\ \Omega$

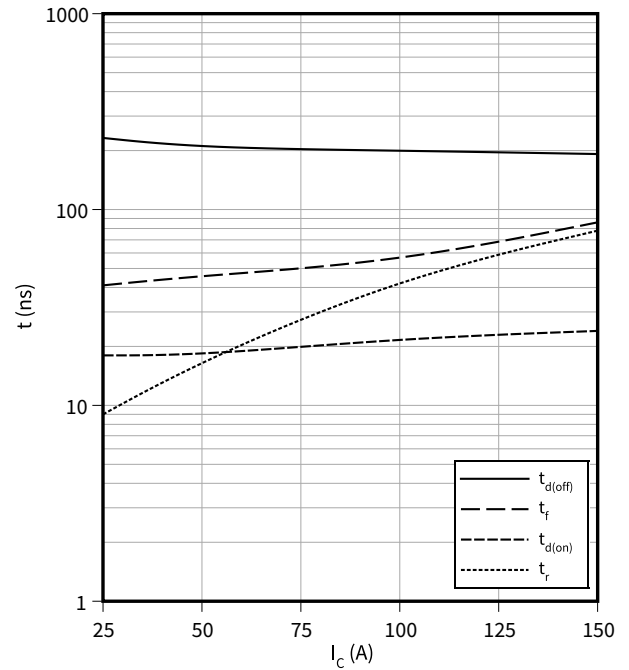

**4 Characteristics diagrams**

**Typical switching times as a function of gate resistor**

$t = f(R_G)$

$I_C = 50\text{ A}, V_{CC} = 400\text{ V}, T_{vj} = 175\text{ °C}, V_{GE} = 0/15\text{ V}$

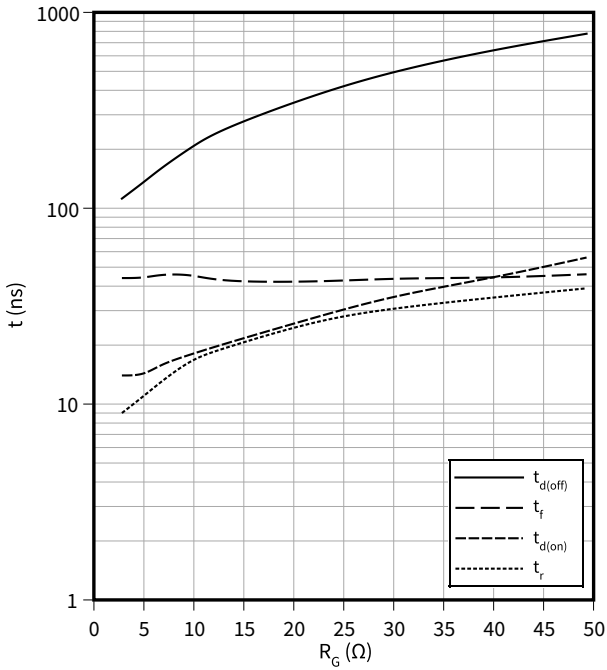

**Typical switching times as a function of junction temperature**

$t = f(T_{vj})$

$I_C = 50\text{ A}, V_{CC} = 400\text{ V}, V_{GE} = 0/15\text{ V}, R_G = 9.8\text{ }\Omega$

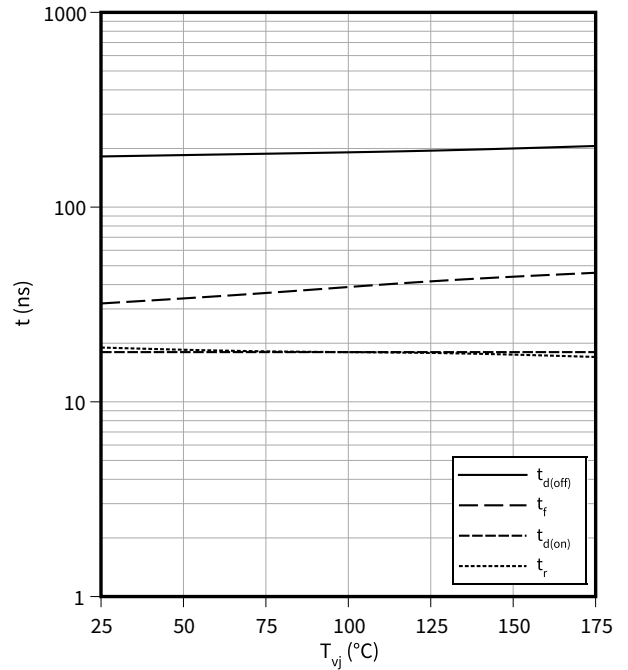

**Typical switching energy losses as a function of collector current**

$E = f(I_C)$

$V_{CC} = 400\text{ V}, T_{vj} = 175\text{ °C}, V_{GE} = 0/15\text{ V}, R_G = 9.8\text{ }\Omega$

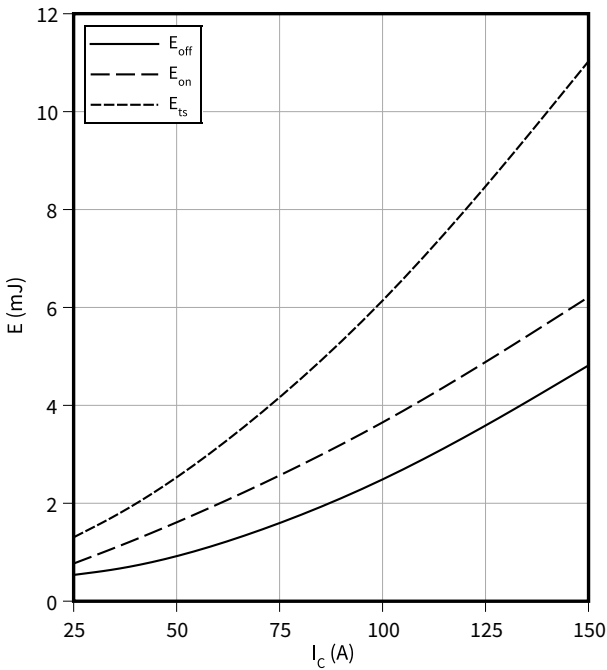

**Typical switching energy losses as a function of gate resistor**

$E = f(R_G)$

$I_C = 50\text{ A}, V_{CC} = 400\text{ V}, T_{vj} = 175\text{ °C}, V_{GE} = 0/15\text{ V}$

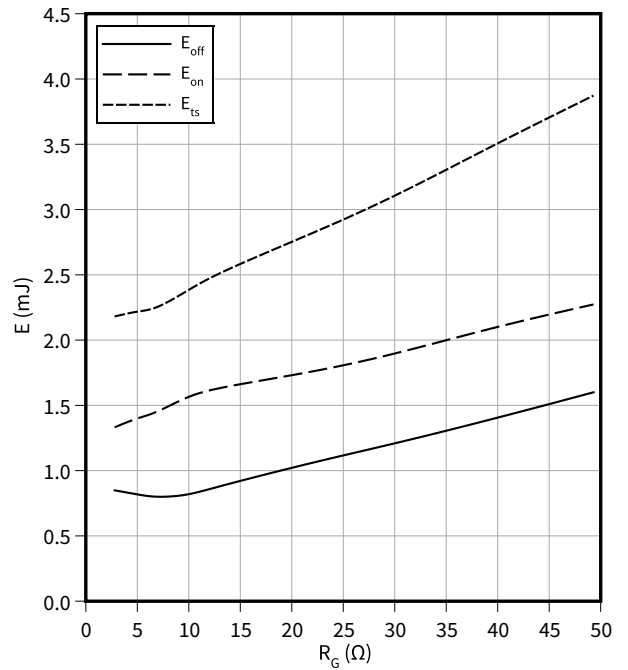

4 Characteristics diagrams

**Typical switching energy losses as a function of junction temperature**

$E = f(T_{vj})$

$I_C = 50 \text{ A}, V_{CC} = 400 \text{ V}, V_{GE} = 0/15 \text{ V}, R_G = 9.8 \Omega$

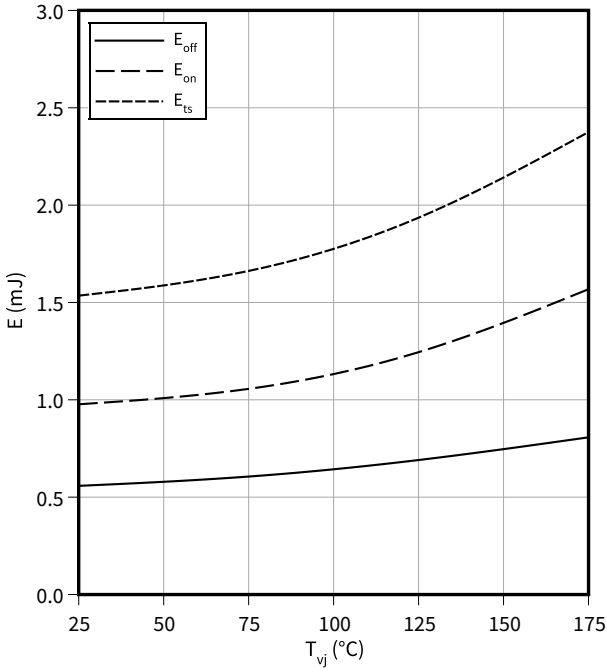

**Typical switching energy losses as a function of collector emitter voltage**

$E = f(V_{CE})$

$I_C = 50 \text{ A}, T_{vj} = 175 \text{ °C}, V_{GE} = 0/15 \text{ V}, R_G = 9.8 \Omega$

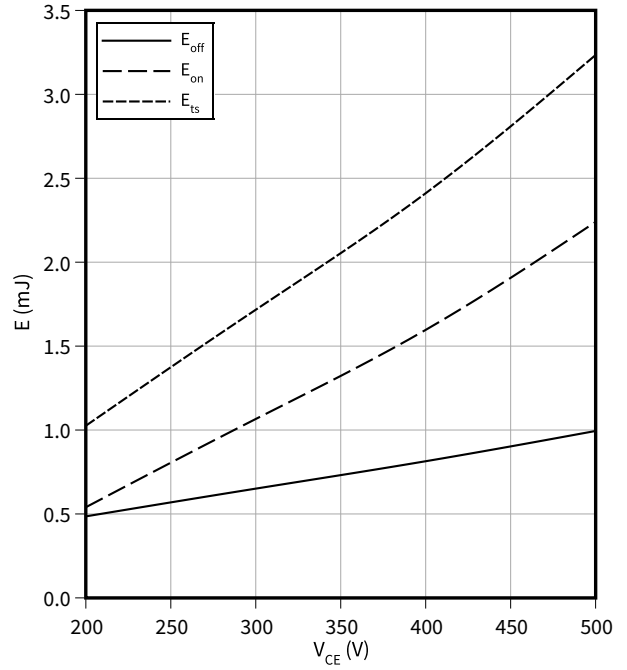

**Typical gate charge**

$V_{GE} = f(Q_G)$

$I_C = 50 \text{ A}$

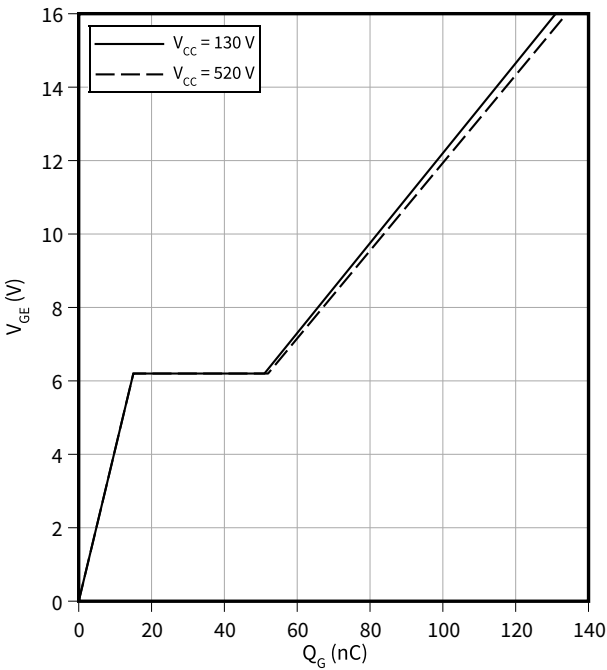

**Typical capacitance as a function of collector-emitter voltage**

$C = f(V_{CE})$

$f = 100 \text{ kHz}, V_{GE} = 0 \text{ V}$

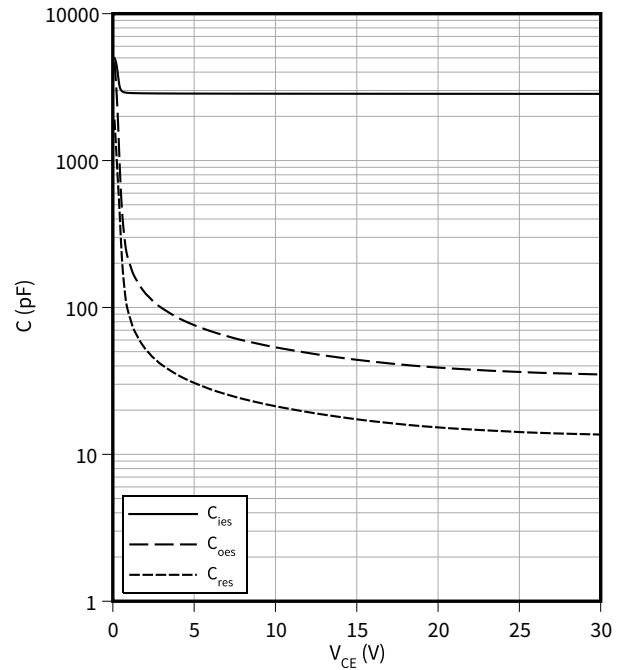

**4 Characteristics diagrams**

**IGBT transient thermal impedance as a function of pulse width**

$$Z_{th(j-c)} = f(t_p)$$

$$D = t_p/T$$

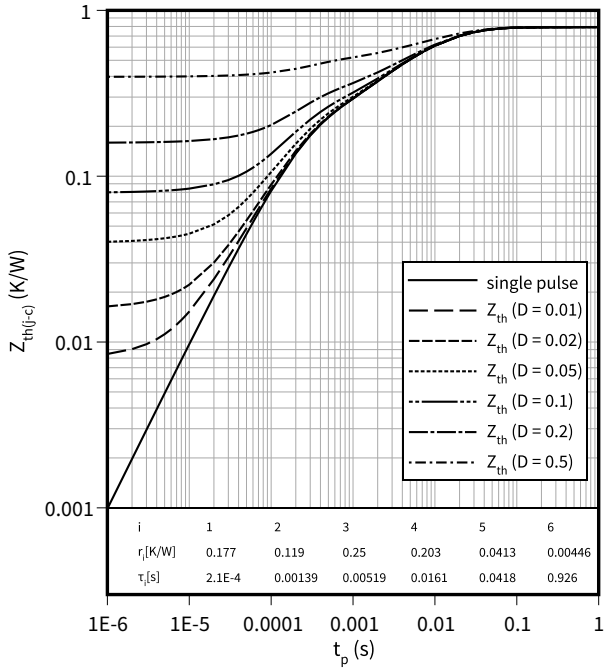

**5 Package outlines**

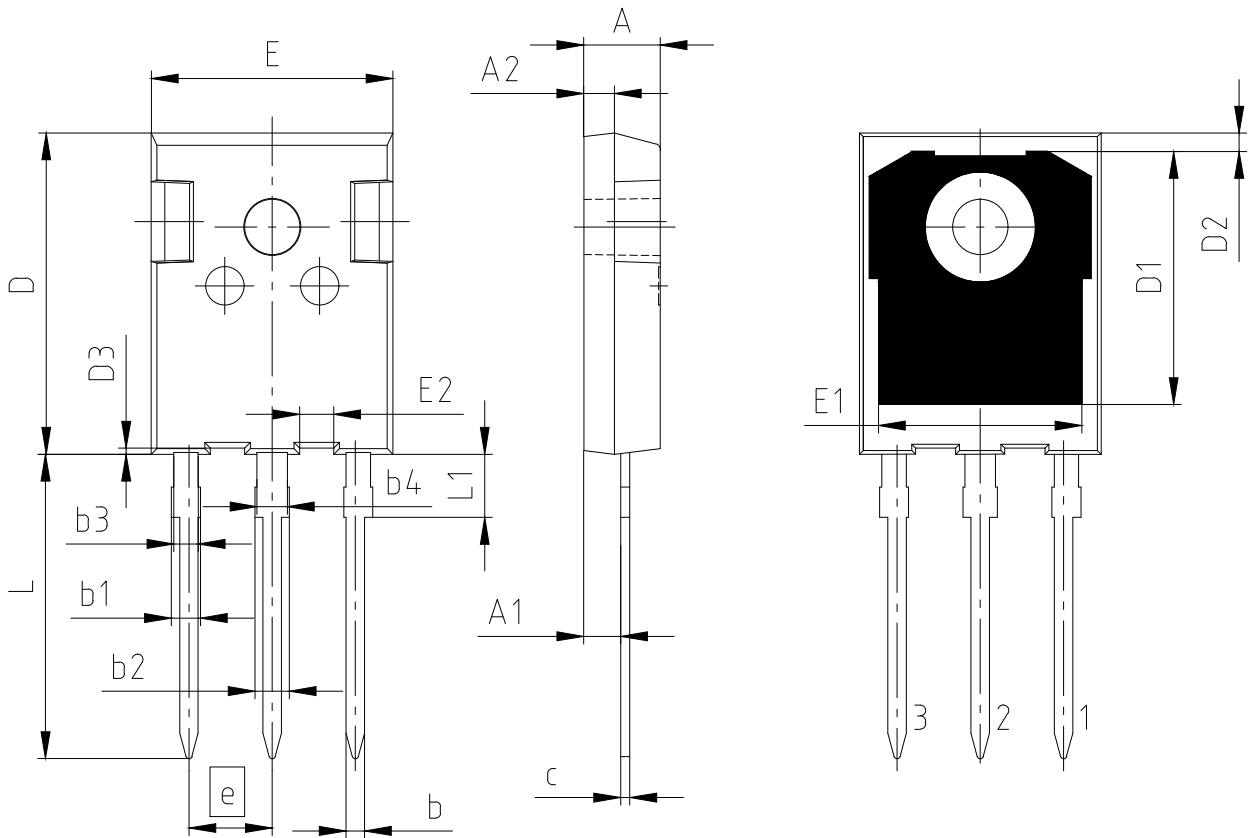

PACKAGE - GROUP NUMBER: <b>PG-TO247-3-U04</b>		
DIMENSIONS	MILLIMETERS	
	MIN.	MAX.
<b>A</b>	4.90	5.10
<b>A1</b>	2.31	2.51
<b>A2</b>	1.90	2.10
<b>b</b>	1.16	1.26
<b>b1</b>		1.90
<b>b2</b>		2.30
<b>b3</b>	1.55	1.65
<b>b4</b>	1.96	2.06
<b>c</b>	0.59	0.66
<b>D</b>	20.90	21.10
<b>D1</b>	16.25	16.85
<b>D2</b>	1.05	1.35
<b>D3</b>	0.55	0.65
<b>E</b>	15.70	15.90
<b>E1</b>	13.10	13.50
<b>E2</b>	2.14	2.34
<b>e</b>	5.44	
<b>N</b>	3	
<b>L</b>	19.80	20.10
<b>L1</b>	3.95	4.30

**Figure 1**

## 6 Testing conditions

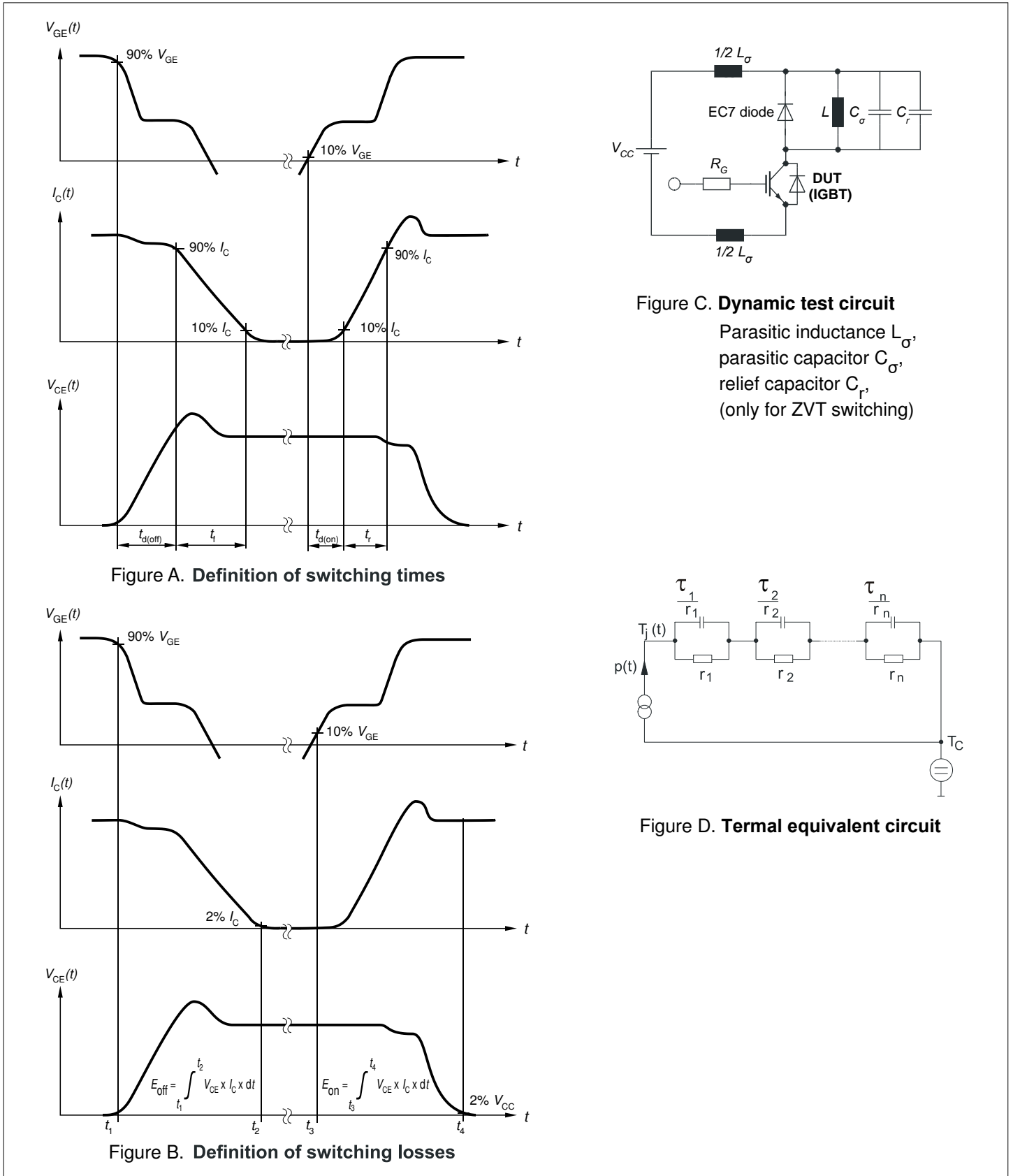

Figure 2

**Revision history**

<b>Document revision</b>	<b>Date of release</b>	<b>Description of changes</b>
0.10	2024-08-13	Preliminary datasheet
1.00	2024-09-23	Final datasheet

## Trademarks

All referenced product or service names and trademarks are the property of their respective owners.

**Edition 2024-09-23**

**Published by**

**Infineon Technologies AG**

**81726 Munich, Germany**

**© 2024 Infineon Technologies AG**

**All Rights Reserved.**

**Do you have a question about any aspect of this document?**

**Email: [erratum@infineon.com](mailto:erratum@infineon.com)**

**Document reference**

**IFX-ABJ844-002**

## Important notice

The information given in this document shall in no event be regarded as a guarantee of conditions or characteristics ("Beschaffheitsgarantie").

With respect to any examples, hints or any typical values stated herein and/or any information regarding the application of the product, Infineon Technologies hereby disclaims any and all warranties and liabilities of any kind, including without limitation warranties of non-infringement of intellectual property rights of any third party.

In addition, any information given in this document is subject to customer's compliance with its obligations stated in this document and any applicable legal requirements, norms and standards concerning customer's products and any use of the product of Infineon Technologies in customer's applications.

The data contained in this document is exclusively intended for technically trained staff. It is the responsibility of customer's technical departments to evaluate the suitability of the product for the intended application and the completeness of the product information given in this document with respect to such application.

Please note that this product is not qualified according to the AEC Q100 or AEC Q101 documents of the Automotive Electronics Council.

## Warnings

Due to technical requirements products may contain dangerous substances. For information on the types in question please contact your nearest Infineon Technologies office.

Except as otherwise explicitly approved by Infineon Technologies in a written document signed by authorized representatives of Infineon Technologies, Infineon Technologies' products may not be used in any applications where a failure of the product or any consequences of the use thereof can reasonably be expected to result in personal injury.

## X-ON Electronics

Largest Supplier of Electrical and Electronic Components

*Click to view similar products for [Infineon manufacturer](#):*

Other Similar products are found below :

[076295C](#) [111-4190PBF](#) [1EBN1001AEXUMA1](#) [1ED020I12-B2](#) [1ED020I12B2XUMA1](#) [1ED020I12-BT](#) [1ED020I12BTXUMA1](#) [1ED020I12-F](#) [1ED020I12-F2](#) [1ED020I12F2XUMA1](#) [1ED020I12FA2](#) [1ED020I12FA2XUMA2](#) [1ED020I12-FT](#) [1ED020I12FTA](#) [1ED020I12FTAXUMA2](#) [1ED21271S65FXUMA1](#) [1ED2127S65FXUMA1](#) [1ED21471S65FXUMA1](#) [1ED2147S65FXUMA1](#) [1ED3120MC12HXUMA1](#) [1ED3120MU12HXUMA1](#) [1ED3121MC12HXUMA1](#) [1ED3121MU12HXUMA1](#) [1ED3122MC12HXUMA1](#) [1ED3122MU12HXUMA1](#) [1ED3123MC12HXUMA1](#) [1ED3123MU12HXUMA1](#) [1ED3124MU12FXUMA1](#) [1ED3124MU12HXUMA1](#) [1ED3125MU12FXUMA1](#) [1ED3131MC12HXUMA1](#) [1ED3131MU12HXUMA1](#) [1ED3140MU12FXUMA1](#) [1ED3141MU12FXUMA1](#) [1ED3142MU12FXUMA1](#) [1ED3240MC12HXUMA1](#) [1ED3241MC12HXUMA1](#) [1ED3250MC12HXUMA1](#) [1ED3321MC12NXUMA1](#) [1ED3323MC12NXUMA1](#) [1ED3431MC12MXUMA1](#) [1ED3431MU12MXUMA1](#) [1ED3461MC12MXUMA1](#) [1ED3461MU12MXUMA1](#) [1ED3491MC12MXUMA1](#) [1ED3491MU12MXUMA1](#) [1ED3860MC12MXUMA1](#) [1ED3860MU12MXUMA1](#) [1ED3890MC12MXUMA1](#) [1ED3890MU12MXUMA1](#)