

### Final datasheet

### Short circuit rugged 1200 V TRENCHSTOP™ IGBT 7 technology

#### Features

- $V_{CE} = 1200\text{ V}$
- $I_C = 15\text{ A}$
- Low saturation voltage  $V_{CEsat} = 2\text{ V}$  at  $T_{vj} = 150^\circ\text{C}$
- Short circuit ruggedness  $8\ \mu\text{s}$
- Wide range of  $dv/dt$  controllability
- Complete product spectrum and PSpice Models: <http://www.infineon.com/igbt/>

#### Potential applications

- Industrial drives

#### Product validation

- Qualified for industrial applications according to the relevant tests of JEDEC47/20/22
- Encapsulation for the application required

#### Description

Package pin definition:

- Pin 1 (G) - gate
- Pin 2 (E) - emitter
- TAB (C) - collector

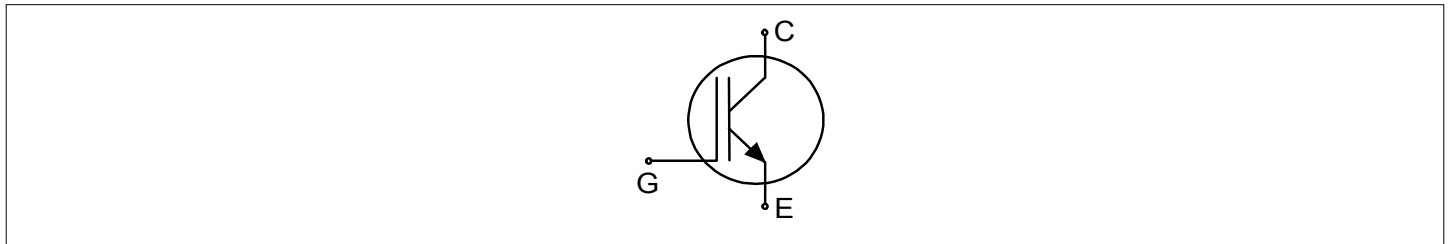
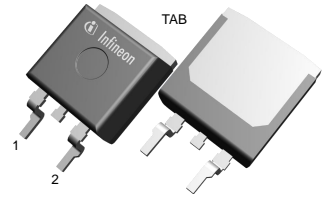

Type	Package	Marking
IGB15N120S7	PG-TO263-3-STD-C1.6	G15MS7

## Table of contents

	<b>Description</b> .....	1
	<b>Features</b> .....	1
	<b>Potential applications</b> .....	1
	<b>Product validation</b> .....	1
	<b>Table of contents</b> .....	2
<b>1</b>	<b>Package</b> .....	3
<b>2</b>	<b>IGBT</b> .....	3
<b>3</b>	<b>Characteristics diagrams</b> .....	6
<b>4</b>	<b>Package outlines</b> .....	11
<b>5</b>	<b>Testing conditions</b> .....	12
	<b>Revision history</b> .....	13
	<b>Disclaimer</b> .....	14

## 1 Package

**Table 1** Characteristic values

Parameter	Symbol	Note or test condition	Values			Unit
			Min.	Typ.	Max.	
Internal emitter inductance measured 5 mm (0.197 in.) from case	$L_E$			7		nH
Storage temperature	$T_{stg}$		-55		150	°C
Soldering temperature	$T_{sold}$	reflow soldering (MSL1 according to JEDEC J-STA-020)			260	°C
Thermal resistance, 6 cm <sup>2</sup> Cu on PCB junction to ambient	$R_{th(j-a)}$				40	K/W
IGBT thermal resistance, junction-case	$R_{th(j-c)}$			0.66	0.89	K/W

## 2 IGBT

**Table 2** Maximum rated values

Parameter	Symbol	Note or test condition	Values	Unit
Collector-emitter voltage	$V_{CE}$	$T_{vj} \geq 25 \text{ °C}$	1200	V
DC collector current, limited by $T_{vjmax}$	$I_C$	$T_c = 25 \text{ °C}$	34 <sup>1)</sup>	A
		$T_c = 100 \text{ °C}$	22	
Pulsed collector current, $t_p$ limited by $T_{vjmax}$	$I_{Cpulse}$		45	A
Turn-off safe operating area		$V_{CE} \leq 1200 \text{ V}, T_{vj} \leq 150 \text{ °C}$	45	A
Gate-emitter voltage	$V_{GE}$		±20	V
Transient gate-emitter voltage	$V_{GE}$	$t_p \leq 0.5 \text{ } \mu\text{s}, D < 0.001$	±25	V
Short-circuit withstand time	$t_{SC}$	$V_{CC} \leq 600 \text{ V}, V_{GE} = 15 \text{ V}$ , Allowed number of short circuits < 1000, Time between short circuits $\geq 1.0 \text{ s}, T_{vj} = 150 \text{ °C}$	8	μs
Power dissipation	$P_{tot}$	$T_c = 25 \text{ °C}$	141	W
		$T_c = 100 \text{ °C}$	56	

1) Limited by bondwire

**Table 3 Characteristic values**

Parameter	Symbol	Note or test condition		Values			Unit
				Min.	Typ.	Max.	
Collector-emitter saturation voltage	$V_{CEsat}$	$I_C = 15\text{ A}, V_{GE} = 15\text{ V}$	$T_{vj} = 25\text{ °C}$		1.65	2	V
			$T_{vj} = 150\text{ °C}$		2		
Gate-emitter threshold voltage	$V_{GETh}$	$I_C = 0.3\text{ mA}, V_{CE} = V_{GE}$		5.15	5.7	6.45	V
Zero gate-voltage collector current	$I_{CES}$	$V_{CE} = 1200\text{ V}, V_{GE} = 0\text{ V}$	$T_{vj} = 25\text{ °C}$			20	$\mu\text{A}$
			$T_{vj} = 150\text{ °C}$		260		
Gate-emitter leakage current	$I_{GES}$	$V_{CE} = 0\text{ V}, V_{GE} = 20\text{ V}$				100	nA
Transconductance	$g_{fs}$	$I_C = 15\text{ A}, V_{CE} = 20\text{ V}, T_{vj} = 150\text{ °C}$			6.7		S
Short-circuit collector current	$I_{SC}$	$V_{CC} \leq 600\text{ V}, V_{GE} = 15\text{ V}, t_{SC} \leq 8\text{ }\mu\text{s}$ , Allowed number of short circuits < 1000, Time between short circuits $\geq 1.0\text{ s}$ , $T_{vj} = 150\text{ °C}$			72		A
Input capacitance	$C_{ies}$	$V_{CE} = 25\text{ V}, V_{GE} = 0\text{ V}, f = 100\text{ kHz}$			2.5		nF
Output capacitance	$C_{oes}$	$V_{CE} = 25\text{ V}, V_{GE} = 0\text{ V}, f = 100\text{ kHz}$			41		pF
Reverse transfer capacitance	$C_{res}$	$V_{CE} = 25\text{ V}, V_{GE} = 0\text{ V}, f = 100\text{ kHz}$			27		pF
Gate charge	$Q_G$	$V_{CC} = 960\text{ V}, I_C = 15\text{ A}, V_{GE} = 15\text{ V}$			97		nC
Turn-on delay time	$t_{d(on)}$	$V_{CC} = 600\text{ V}, V_{GE} = 0/15\text{ V}, R_{G(on)} = 10\text{ }\Omega, R_{G(off)} = 10\text{ }\Omega$	$T_{vj} = 25\text{ °C}, I_C = 15\text{ A}$		16		ns
			$T_{vj} = 150\text{ °C}, I_C = 15\text{ A}$		16		
Rise time (inductive load)	$t_r$	$V_{CC} = 600\text{ V}, V_{GE} = 0/15\text{ V}, R_{G(on)} = 10\text{ }\Omega, R_{G(off)} = 10\text{ }\Omega$	$T_{vj} = 25\text{ °C}, I_C = 15\text{ A}$		17		ns
			$T_{vj} = 150\text{ °C}, I_C = 15\text{ A}$		19		
Turn-off delay time	$t_{d(off)}$	$V_{CC} = 600\text{ V}, V_{GE} = 0/15\text{ V}, R_{G(on)} = 10\text{ }\Omega, R_{G(off)} = 10\text{ }\Omega$	$T_{vj} = 25\text{ °C}, I_C = 15\text{ A}$		156		ns
			$T_{vj} = 150\text{ °C}, I_C = 15\text{ A}$		223		
Fall time (inductive load)	$t_f$	$V_{CC} = 600\text{ V}, V_{GE} = 0/15\text{ V}, R_{G(on)} = 10\text{ }\Omega, R_{G(off)} = 10\text{ }\Omega$	$T_{vj} = 25\text{ °C}, I_C = 15\text{ A}$		111		ns
			$T_{vj} = 150\text{ °C}, I_C = 15\text{ A}$		216		
Turn-on energy	$E_{on}$	$V_{CC} = 600\text{ V}, V_{GE} = 0/15\text{ V}, R_{G(on)} = 10\text{ }\Omega, R_{G(off)} = 10\text{ }\Omega$	$T_{vj} = 25\text{ °C}, I_C = 15\text{ A}$		0.9		mJ
			$T_{vj} = 150\text{ °C}, I_C = 15\text{ A}$		1.3		

**(table continues...)**

**Table 3 (continued) Characteristic values**

Parameter	Symbol	Note or test condition	Values			Unit
			Min.	Typ.	Max.	
Turn-off energy	$E_{off}$	$V_{CC} = 600\text{ V}, V_{GE} = 0/15\text{ V},$ $R_{G(on)} = 10\ \Omega,$ $R_{G(off)} = 10\ \Omega$	$T_{vj} = 25\text{ }^\circ\text{C},$ $I_C = 15\text{ A}$		0.68	mJ
			$T_{vj} = 150\text{ }^\circ\text{C},$ $I_C = 15\text{ A}$		1.3	
Total switching energy	$E_{ts}$	$V_{CC} = 600\text{ V}, V_{GE} = 0/15\text{ V},$ $R_{G(on)} = 10\ \Omega,$ $R_{G(off)} = 10\ \Omega$	$T_{vj} = 25\text{ }^\circ\text{C},$ $I_C = 15\text{ A}$		1.58	mJ
			$T_{vj} = 150\text{ }^\circ\text{C},$ $I_C = 15\text{ A}$		2.63	
Operating junction temperature	$T_{vj}$		-40		150	$^\circ\text{C}$

**Note:** For optimum lifetime and reliability, Infineon recommends operating conditions that do not exceed 80% of the maximum ratings stated in this datasheet.

Electrical Characteristic at  $T_{vj} = 25\text{ }^\circ\text{C}$ , unless otherwise specified.

Dynamic test circuit, parasitic inductance  $L_\sigma = 45\text{ nH}$ , parasitic capacitor  $C_\sigma = 25\text{ pF}$  from Fig. E. Energy losses include “tail” and diode (IKW15N120CS7) reverse recovery.

### 3 Characteristics diagrams

**Typical output characteristic**

$I_C = f(V_{CE})$

$T_{vj} = 25\text{ °C}$

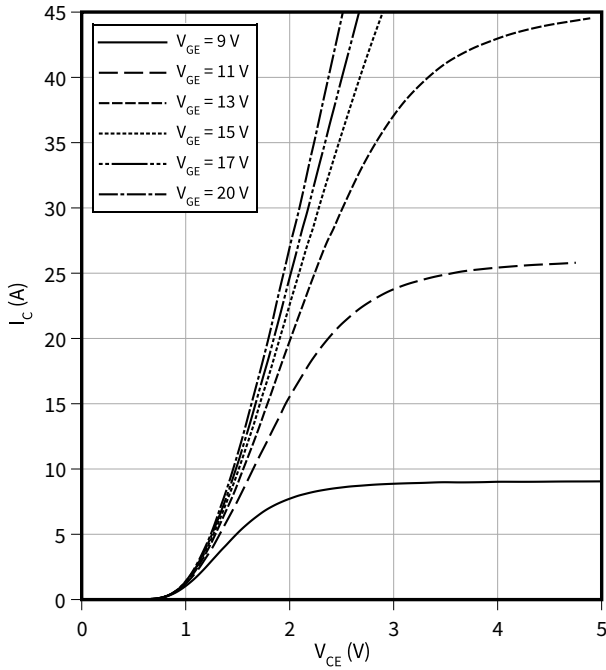

**Typical output characteristic**

$I_C = f(V_{CE})$

$T_{vj} = 150\text{ °C}$

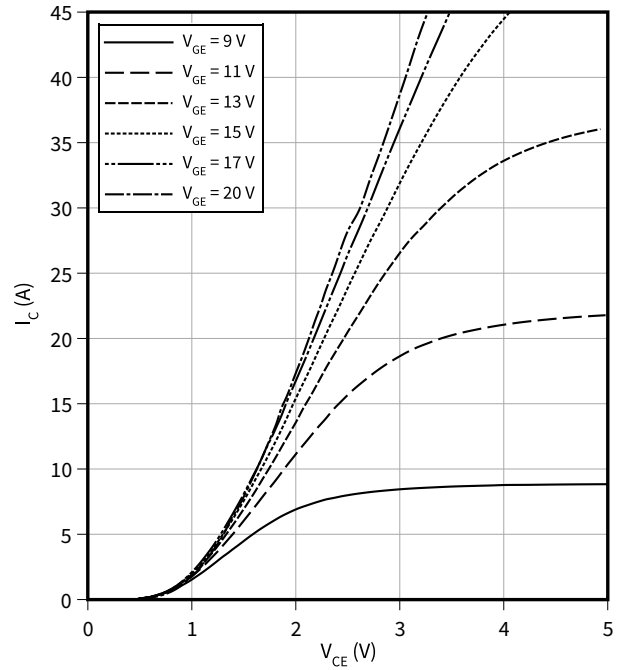

**Typical transfer characteristic**

$I_C = f(V_{GE})$

$V_{CE} = 20\text{ V}$

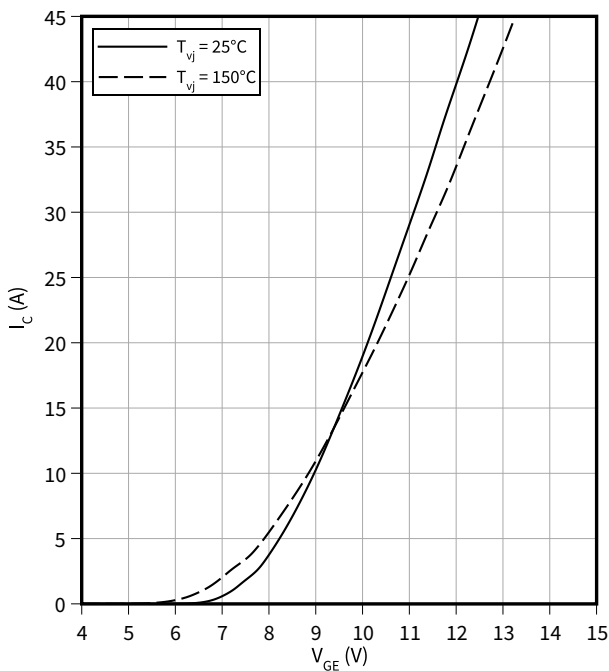

**Typical collector-emitter saturation voltage as a function of junction temperature**

$V_{CEsat} = f(T_{vj})$

$V_{GE} = 15\text{ V}$

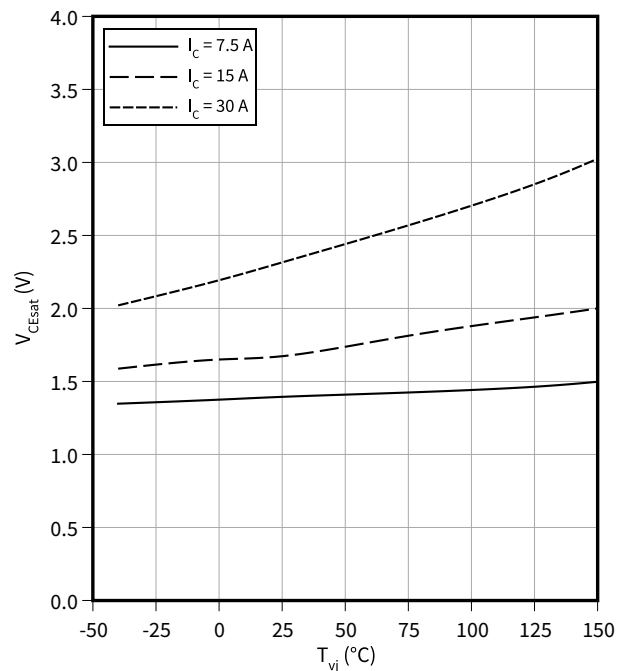

3 Characteristics diagrams

**Gate-emitter threshold voltage as a function of junction temperature**

$V_{GEth} = f(T_{vj})$   
 $I_C = 0.3 \text{ mA}$

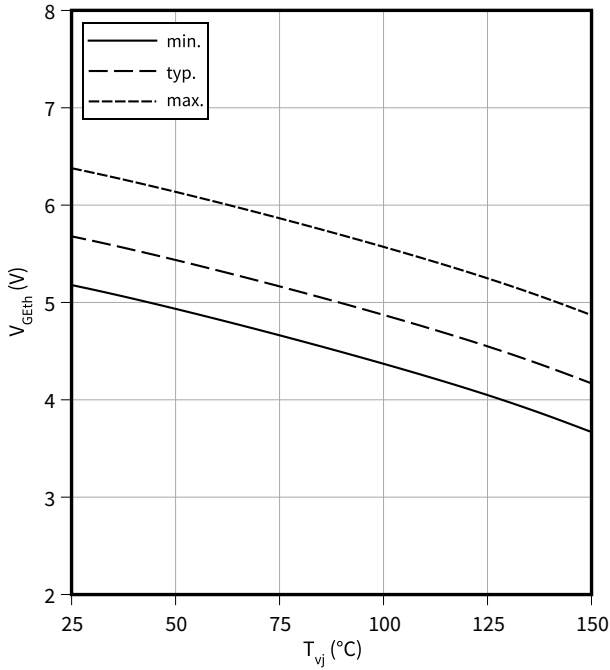

**Typical switching times as a function of collector current**

$t = f(I_C)$   
 $V_{CC} = 600 \text{ V}, T_{vj} = 150 \text{ °C}, V_{GE} = 0/15 \text{ V}, R_G = 10 \text{ } \Omega$

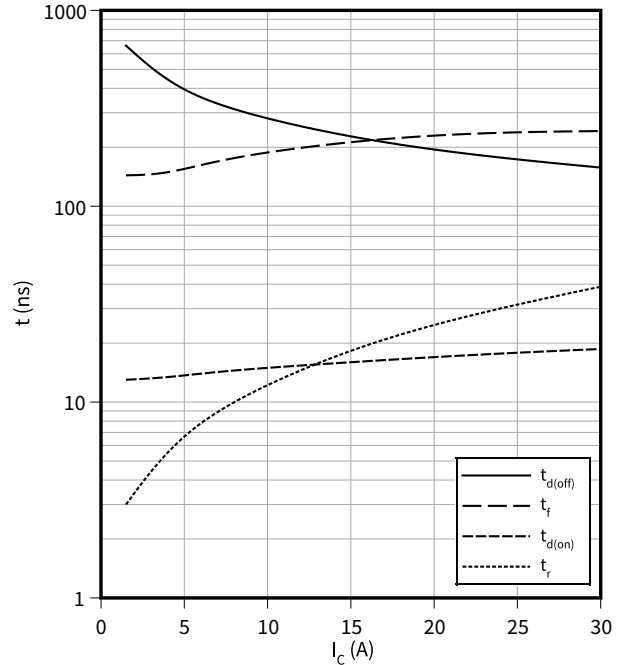

**Typical switching times as a function of gate resistor**

$t = f(R_G)$   
 $I_C = 15 \text{ A}, V_{CC} = 600 \text{ V}, T_{vj} = 150 \text{ °C}, V_{GE} = 0/15 \text{ V}$

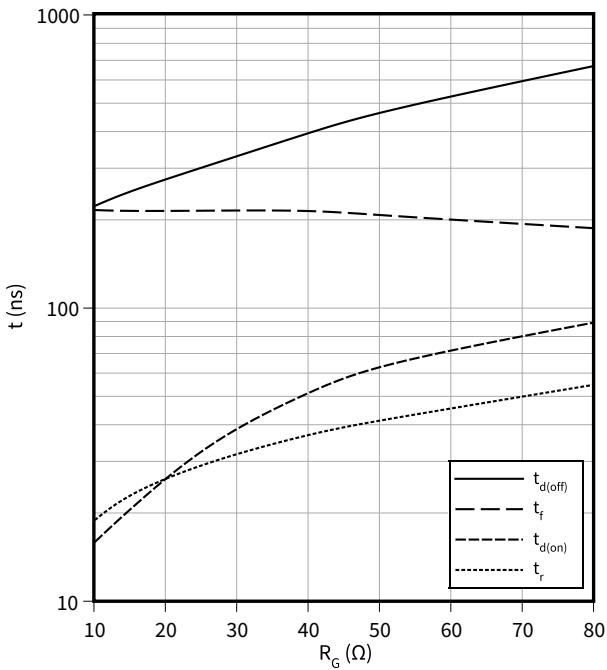

**Typical switching times as a function of junction temperature**

$t = f(T_{vj})$   
 $I_C = 15 \text{ A}, V_{CC} = 600 \text{ V}, V_{GE} = 0/15 \text{ V}, R_G = 10 \text{ } \Omega$

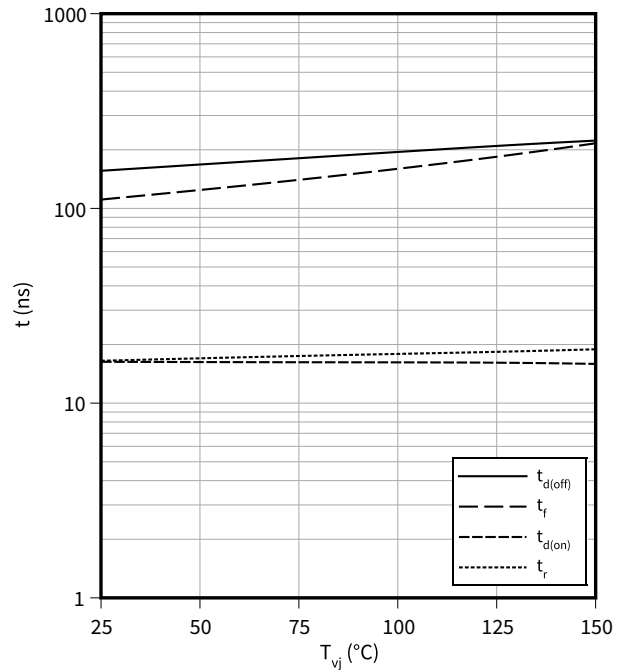

3 Characteristics diagrams

**Typical switching energy losses as a function of collector current**

$E = f(I_C)$

$V_{CC} = 600\text{ V}, T_{vj} = 150\text{ °C}, V_{GE} = 0/15\text{ V}, R_G = 10\text{ }\Omega$

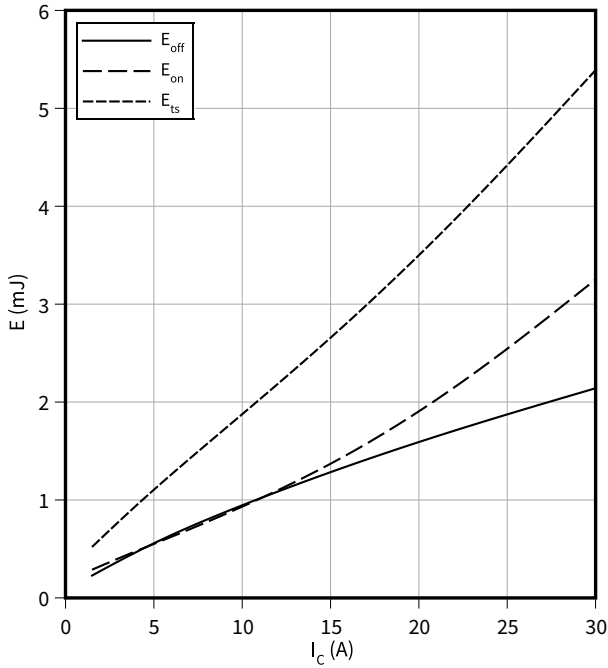

**Typical switching energy losses as a function of gate resistor**

$E = f(R_G)$

$I_C = 15\text{ A}, V_{CC} = 600\text{ V}, T_{vj} = 150\text{ °C}, V_{GE} = 0/15\text{ V}$

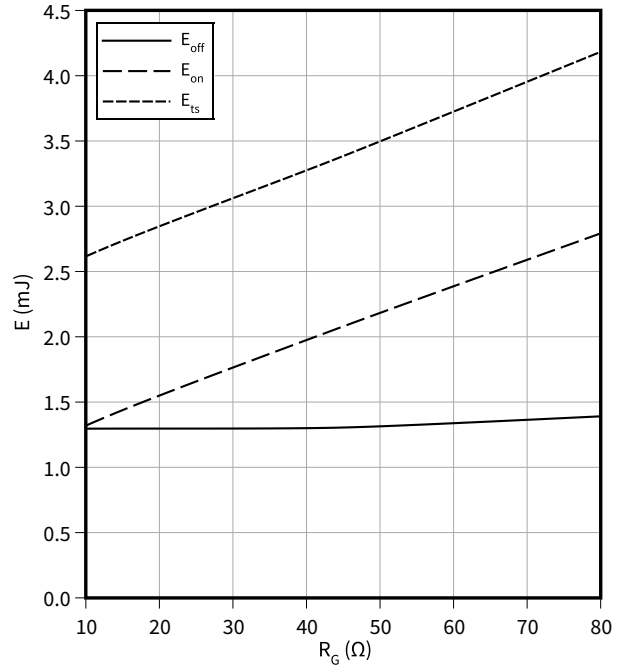

**Typical switching energy losses as a function of junction temperature**

$E = f(T_{vj})$

$I_C = 15\text{ A}, V_{CC} = 600\text{ V}, V_{GE} = 0/15\text{ V}, R_G = 10\text{ }\Omega$

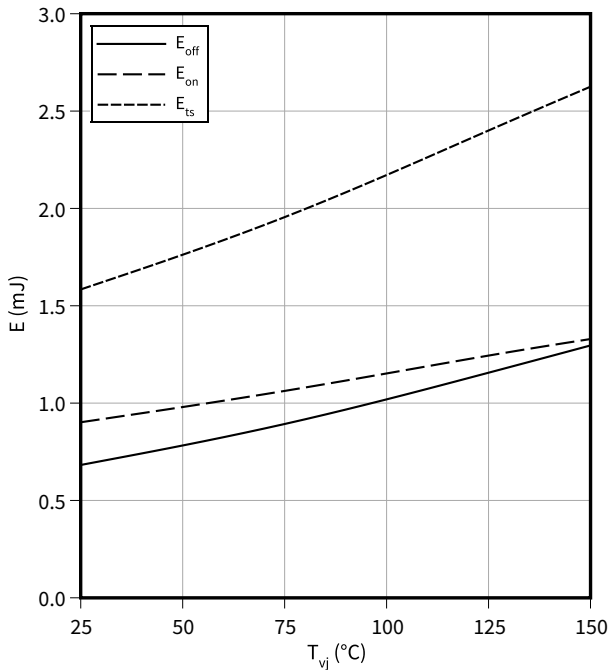

**Typical switching energy losses as a function of collector emitter voltage**

$E = f(V_{CE})$

$I_C = 15\text{ A}, T_{vj} = 150\text{ °C}, V_{GE} = 0/15\text{ V}, R_G = 10\text{ }\Omega$

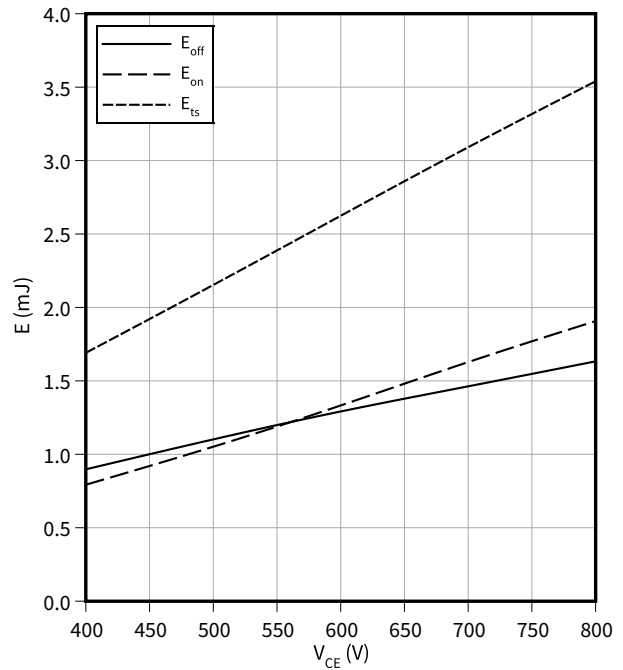

3 Characteristics diagrams

**Typical gate charge**

$V_{GE} = f(Q_G)$

$I_C = 15 \text{ A}$

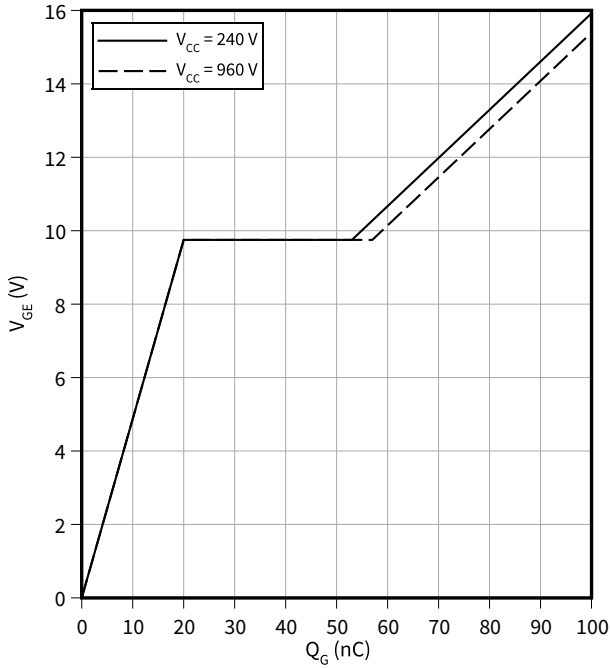

**Typical capacitance as a function of collector-emitter voltage**

$C = f(V_{CE})$

$f = 100 \text{ kHz}, V_{GE} = 0 \text{ V}$

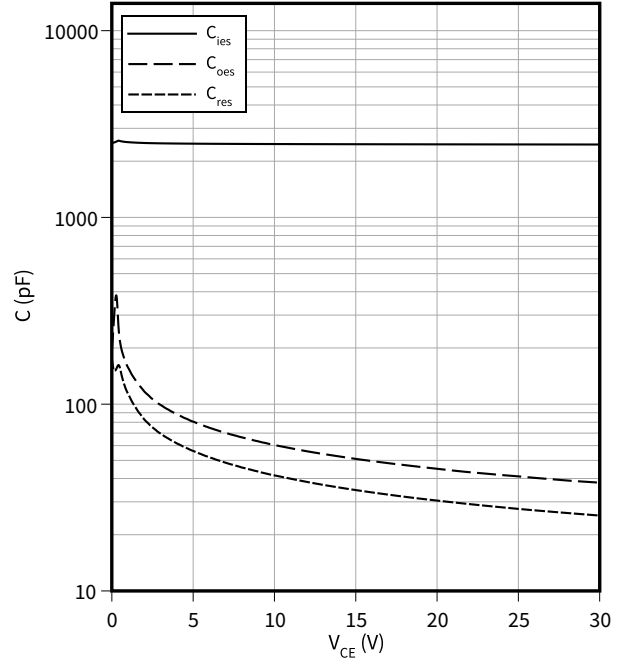

**Typical short circuit collector current as a function of gate-emitter voltage**

$I_{C(SC)} = f(V_{GE})$

$T_{vj} = 150 \text{ }^\circ\text{C}, V_{CC} = 600 \text{ V}$

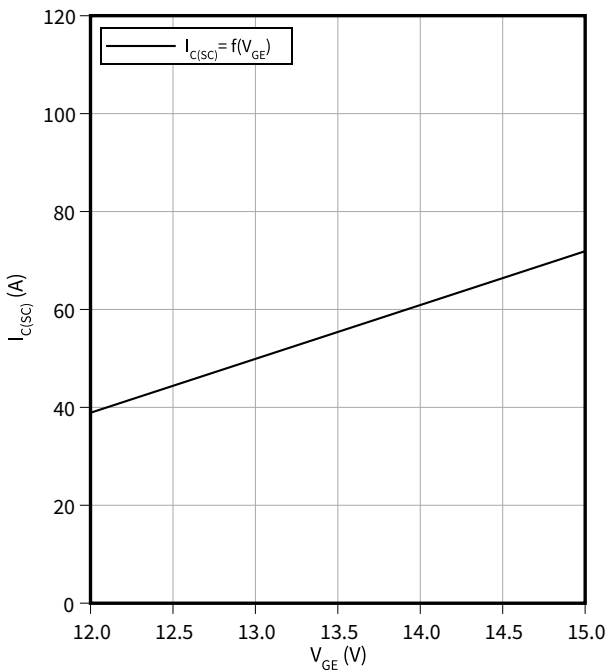

**Short circuit withstand time as a function of gate-emitter voltage**

$t_{SC} = f(V_{GE})$

$T_{vj} = 150 \text{ }^\circ\text{C}, V_{CC} = 600 \text{ V}$

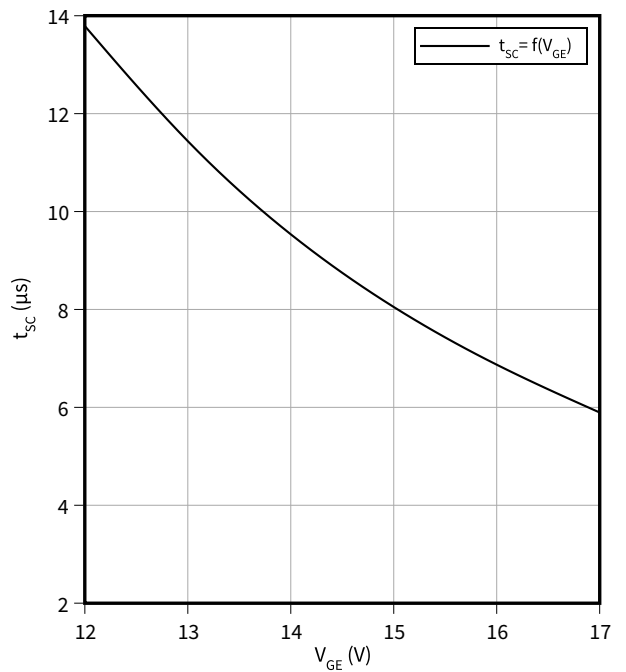

3 Characteristics diagrams

**IGBT transient thermal impedance as a function of pulse width**

$$Z_{th(j-c)} = f(t_p)$$

$$D = t_p/T$$

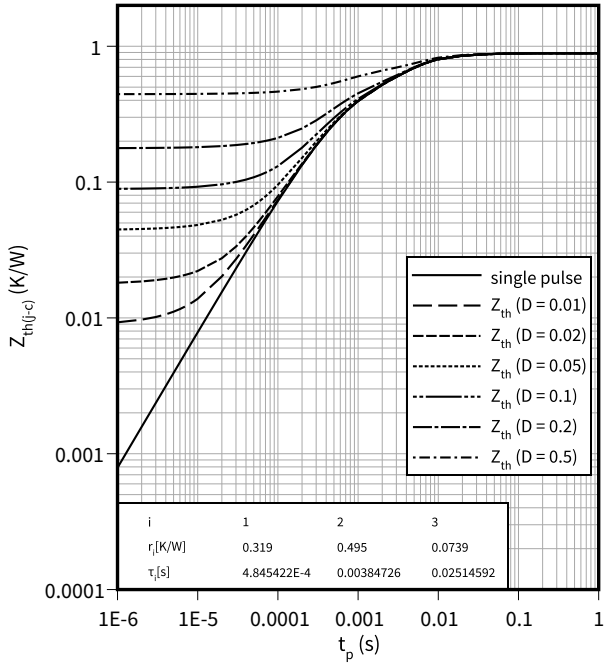

4 Package outlines

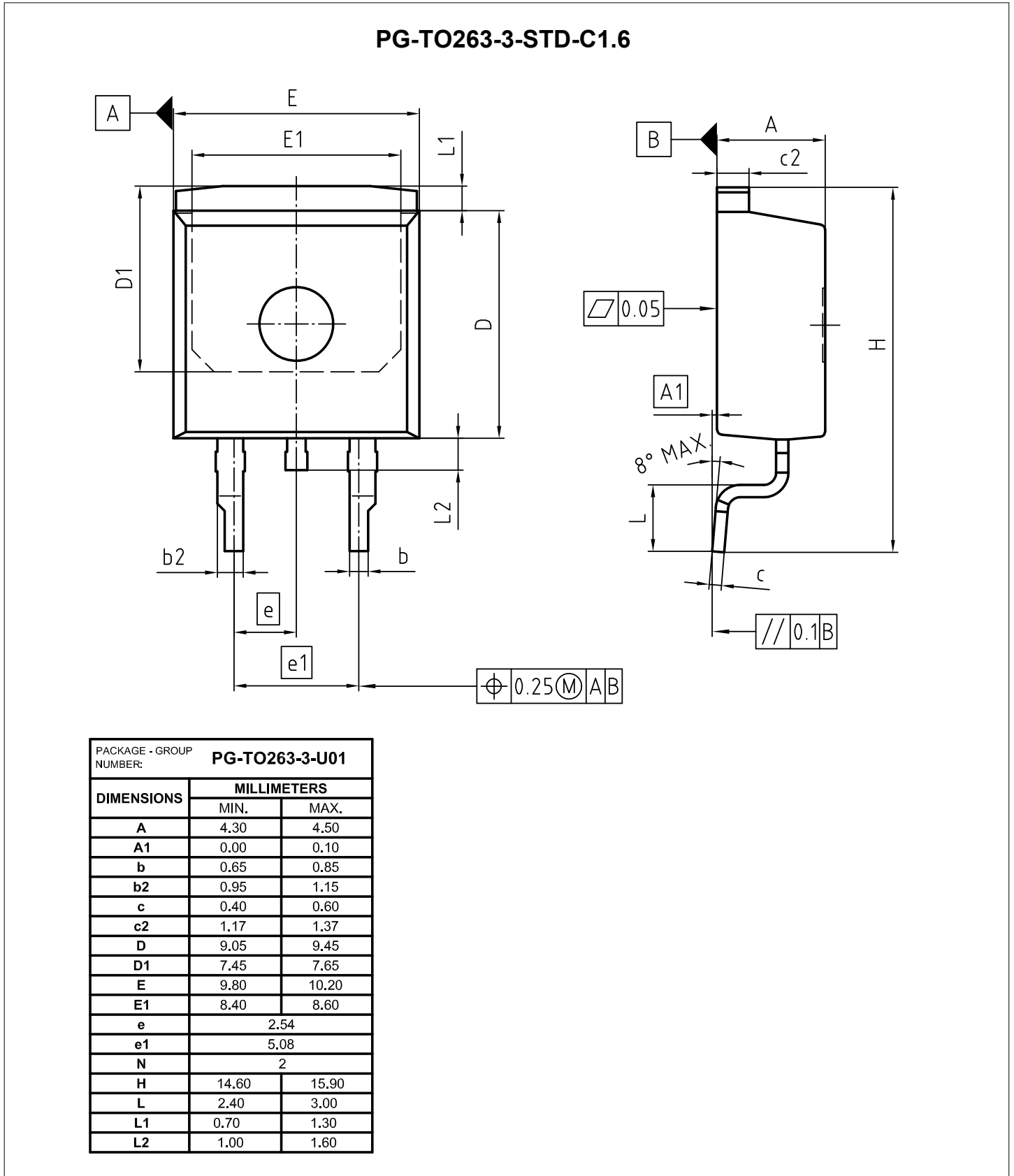
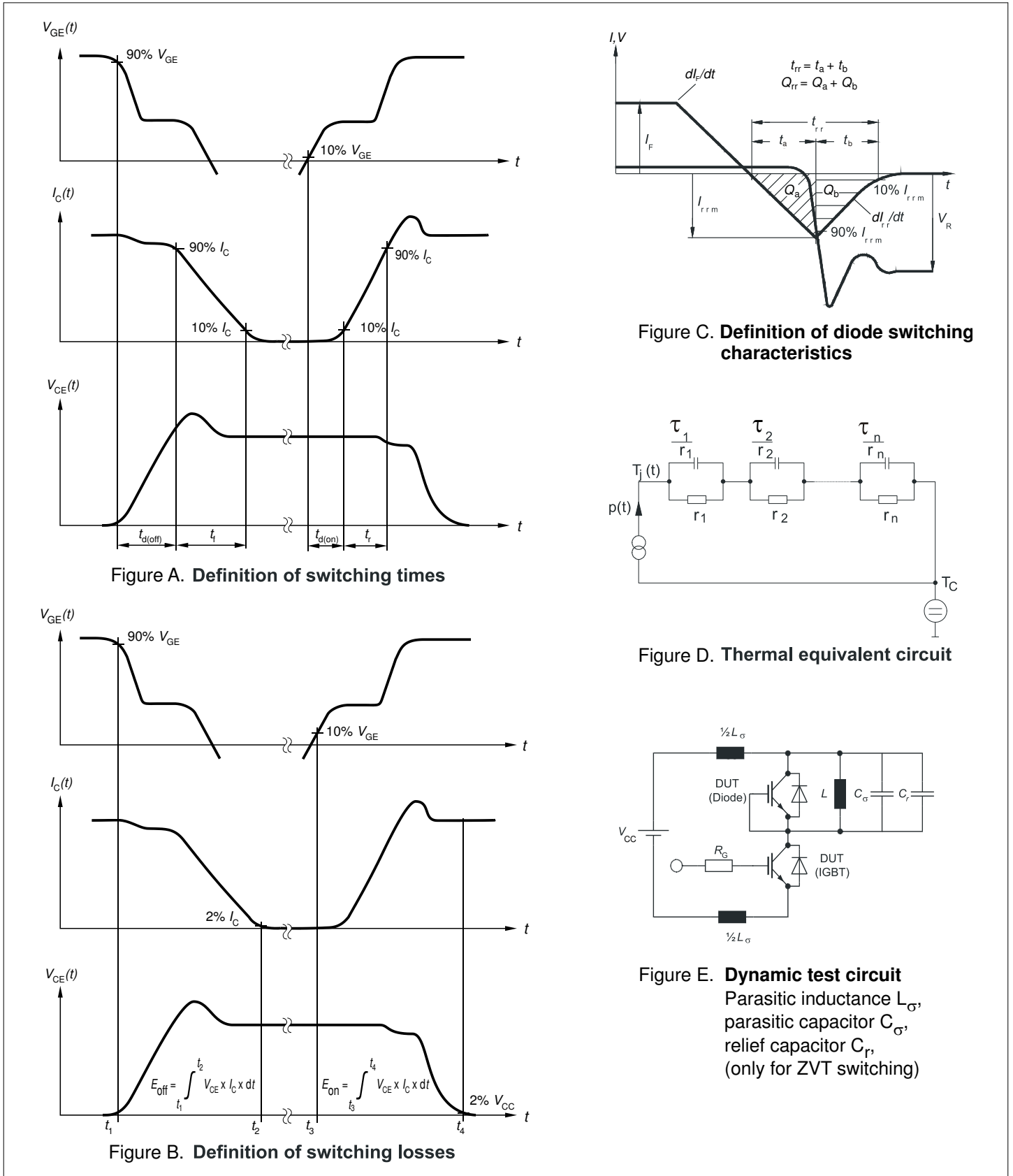

Figure 1

**5 Testing conditions**



**Figure 2**

## Revision history

Document revision	Date of release	Description of changes
1.00	2024-03-11	Final datasheet

## Trademarks

All referenced product or service names and trademarks are the property of their respective owners.

**Edition 2024-03-11**

**Published by**

**Infineon Technologies AG**

**81726 Munich, Germany**

**© 2024 Infineon Technologies AG**

**All Rights Reserved.**

**Do you have a question about any aspect of this document?**

**Email: [erratum@infineon.com](mailto:erratum@infineon.com)**

**Document reference**

**IFX-ABJ882-001**

## Important notice

The information given in this document shall in no event be regarded as a guarantee of conditions or characteristics ("Beschaffheitsgarantie").

With respect to any examples, hints or any typical values stated herein and/or any information regarding the application of the product, Infineon Technologies hereby disclaims any and all warranties and liabilities of any kind, including without limitation warranties of non-infringement of intellectual property rights of any third party.

In addition, any information given in this document is subject to customer's compliance with its obligations stated in this document and any applicable legal requirements, norms and standards concerning customer's products and any use of the product of Infineon Technologies in customer's applications.

The data contained in this document is exclusively intended for technically trained staff. It is the responsibility of customer's technical departments to evaluate the suitability of the product for the intended application and the completeness of the product information given in this document with respect to such application.

Please note that this product is not qualified according to the AEC Q100 or AEC Q101 documents of the Automotive Electronics Council.

## Warnings

Due to technical requirements products may contain dangerous substances. For information on the types in question please contact your nearest Infineon Technologies office.

Except as otherwise explicitly approved by Infineon Technologies in a written document signed by authorized representatives of Infineon Technologies, Infineon Technologies' products may not be used in any applications where a failure of the product or any consequences of the use thereof can reasonably be expected to result in personal injury.

## X-ON Electronics

Largest Supplier of Electrical and Electronic Components

*Click to view similar products for [Infineon manufacturer](#):*

Other Similar products are found below :

[076295C](#) [111-4190PBF](#) [1EBN1001AEXUMA1](#) [1ED020I12-B2](#) [1ED020I12B2XUMA1](#) [1ED020I12-BT](#) [1ED020I12BTXUMA1](#) [1ED020I12-F](#) [1ED020I12-F2](#) [1ED020I12F2XUMA1](#) [1ED020I12FA2](#) [1ED020I12FA2XUMA2](#) [1ED020I12-FT](#) [1ED020I12FTA](#) [1ED020I12FTAXUMA2](#) [1ED21271S65FXUMA1](#) [1ED2127S65FXUMA1](#) [1ED21471S65FXUMA1](#) [1ED2147S65FXUMA1](#) [1ED3120MC12HXUMA1](#) [1ED3120MU12HXUMA1](#) [1ED3121MC12HXUMA1](#) [1ED3121MU12HXUMA1](#) [1ED3122MC12HXUMA1](#) [1ED3122MU12HXUMA1](#) [1ED3123MC12HXUMA1](#) [1ED3123MU12HXUMA1](#) [1ED3124MU12FXUMA1](#) [1ED3124MU12HXUMA1](#) [1ED3125MU12FXUMA1](#) [1ED3131MC12HXUMA1](#) [1ED3131MU12HXUMA1](#) [1ED3140MU12FXUMA1](#) [1ED3141MU12FXUMA1](#) [1ED3142MU12FXUMA1](#) [1ED3240MC12HXUMA1](#) [1ED3241MC12HXUMA1](#) [1ED3250MC12HXUMA1](#) [1ED3321MC12NXUMA1](#) [1ED3323MC12NXUMA1](#) [1ED3431MC12MXUMA1](#) [1ED3431MU12MXUMA1](#) [1ED3461MC12MXUMA1](#) [1ED3461MU12MXUMA1](#) [1ED3491MC12MXUMA1](#) [1ED3491MU12MXUMA1](#) [1ED3860MC12MXUMA1](#) [1ED3860MU12MXUMA1](#) [1ED3890MC12MXUMA1](#) [1ED3890MU12MXUMA1](#)