



### Features

- 3rd generation SiC MOSFET technology
- Optimized package with separate driver source pin
- High blocking voltage with low on-resistance
- High-speed switching with low capacitances
- Fast intrinsic diode with low reverse recovery ( $Q_{rr}$ )
- Halogen free, RoHS compliant

### Benefits

- Reduce switching losses and minimize gate ringing
- Higher system efficiency
- Reduce cooling requirements
- Increase power density
- Increase system switching frequency

### Applications

- Renewable energy
- EV battery chargers
- High voltage DC/DC converters
- Switch Mode Power Supplies

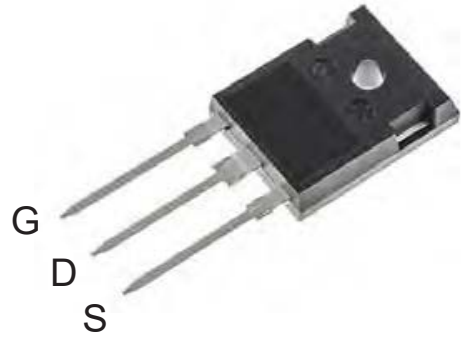

TO-247  
Package

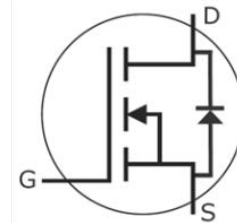

| Ordering Part Number | Package | Marking    |
|----------------------|---------|------------|
| HC1M60120D           | TO-247  | HC1M60120D |

### Maximum Ratings ( $T_C = 25^\circ\text{C}$ unless otherwise specified)

| Parameter   | Symbol         | Value      | Unit             |
|---|----------------|------------|------------------|
| Drain-source voltage  | $V_{DS}$       | 1200       | V                |
| Continuous drain current  | $I_D$          | 40         | A                |
| $T_C = 25^\circ\text{C}$  |                | 28         |                  |
| $T_C = 100^\circ\text{C}$   |                |            |                  |
| Pulsed drain current ( $T_C = 25^\circ\text{C}$ , $t_p$ limited by $T_{jmax}$ ) | $I_{D\ pulse}$ | 80         | A                |
| Avalanche energy, single pulse ( $L=10\text{mH}$ )                              | $E_{AS}$       | 600        | mJ               |
| Gate-Source voltage   | $V_{GS}$       | -4/+18     | V                |
| Gate-Source voltage (Absolute maximum values)                                   | $V_{GSmax}$    | -8/+22     | V                |
| Power dissipation ( $T_C = 25^\circ\text{C}$ )                                  | $P_{tot}$      | 214        | W                |
| Operating junction and storage temperature                                      | $T_j, T_{stg}$ | -55...+175 | $^\circ\text{C}$ |

• Example of acceptable  $V_{GS}$  waveform





**Thermal Resistance**

| Parameter                                   | Symbol     | Value | Unit |
|---|------------|-------|------|
| Thermal resistance, junction – case. Max    | $R_{thJC}$ | 0.70  | °C/W |
| Thermal resistance, junction – ambient. Max | $R_{thJA}$ | 40    |      |

**Electrical Characteristic** (at  $T_J = 25\text{ }^\circ\text{C}$ , unless otherwise specified)

| Parameter | Symbol | Value |      |      | Unit | Test Condition |
|-----------|--------|-------|------|------|------|----------------|
|           |        | min.  | typ. | max. |      |                |

**Static Characteristic**

|                                  |              |      |     |     |            |   |
|----------------------------------|--------------|------|-----|-----|------------|---|
| Drain-source breakdown voltage   | $BV_{DSS}$   | 1200 | -   | -   | V          | $V_{GS}=0V, I_D=100\mu A$                     |
| Gate threshold voltage           | $V_{GS(th)}$ | 2.3  | 2.8 | 3.6 | V          | $V_{DS}=V_{GS}, I_D=5mA$                      |
| Zero gate voltage drain current  | $I_{DSS}$    | -    | 1   | 10  | $\mu A$    | $V_{DS}=1200V, V_{GS}=0V$<br>$T_C=25^\circ C$ |
|                                  |              | -    | 5   | -   |            | $T_C=175^\circ C$                             |
| Gate-source leakage current      | $I_{GSS}$    | -    | -   | 100 | nA         | $V_{GS}=18V, V_{DS}=0V$                       |
| Drain-source on-state resistance | $R_{DS(on)}$ | -    | 60  | 75  | m $\Omega$ | $V_{GS}=18V, I_D=20A,$<br>$T_J=25^\circ C$    |
|                                  |              | -    | 120 | -   |            | $T_J=175^\circ C$                             |
| Transconductance                 | $g_{fs}$     | -    | 10  | -   | S          | $V_{DS}=20V, I_D=20A$                         |

**Dynamic Characteristic**

|                              |              |   |     |   |          |   |                         |
|------------------------------|--------------|---|-----|---|----------|---|-------------------------|
| Input Capacitance            | $C_{iss}$    | - | 940 | - | pF       | $V_{DS} = 1000V$<br>$V_{GS} = 0V$<br>$T_J = 25^\circ C$<br>$V_{AC} = 25mV$<br>$f = 1MHz$  |                         |
| Output Capacitance           | $C_{oss}$    | - | 59  | - |          |   |                         |
| Reverse Transfer Capacitance | $C_{riss}$   | - | 4.1 | - |          |   |                         |
| Gate Total Charge            | $Q_G$        | - | 42  | - | nC       | $V_{DS} = 800V$<br>$V_{GS} = -4/+18V$<br>$I_D = 20A$                                      |                         |
| Gate-Source charge           | $Q_{gs}$     | - | 8   | - |          |   |                         |
| Gate-Drain charge            | $Q_{gd}$     | - | 20  | - |          |   |                         |
| Turn-On Switching Energy     | $E_{ON}$     | - | 330 | - | $\mu J$  | $V_{DD} = 800V$<br>$V_{GS} = -4/+15V$<br>$I_D = 20A$<br>$R_G = 0\Omega$<br>$L = 120\mu H$ |                         |
| Turn-Off Switching Energy    | $E_{OFF}$    | - | 51  | - |          |   |                         |
| Turn-on delay time           | $t_{d(on)}$  | - | 21  | - | ns       |   |                         |
| Rise time                    | $t_r$        | - | 23  | - |          |   |                         |
| Turn-off delay time          | $t_{d(off)}$ | - | 16  | - |          |   |                         |
| Fall time                    | $t_f$        | - | 19  | - |          |   |                         |
| Gate resistance              | $R_G$        | - | 1.7 | - | $\Omega$ |   | $V_{AC} = 25mV, f=1MHz$ |



Body Diode Characteristic

| Parameter                          | Symbol   | Value |      |      | Unit | Test Condition  |
|------------------------------------|----------|-------|------|------|------|---|
|                                    |          | min.  | typ. | max. |      |   |
| Body Diode Forward Voltage         | $V_{SD}$ |       | 4.3  |      | V    | $V_{GS}=-4V, I_{SD}=10A, T_J=25^{\circ}C$   |
|                                    |          |       | 3.8  |      |      | $V_{GS}=-4V, I_{SD}=10A, T_J=175^{\circ}C$  |
| Body Diode Reverse Recovery Time   | $t_{rr}$ | -     | 43   | -    | ns   | $V_R = 800V, V_{GS} = -4V$<br>$I_D = 20A$<br>$di/dt = 700A/\mu S$<br>$T_J = 150^{\circ}C$ |
| Body Diode Reverse Recovery Charge | $Q_{rr}$ | -     | 413  | -    | nC   |   |

Typical Performance Characteristics

Fig 1. Output Characteristic ( $T_J=-40^{\circ}C$ )

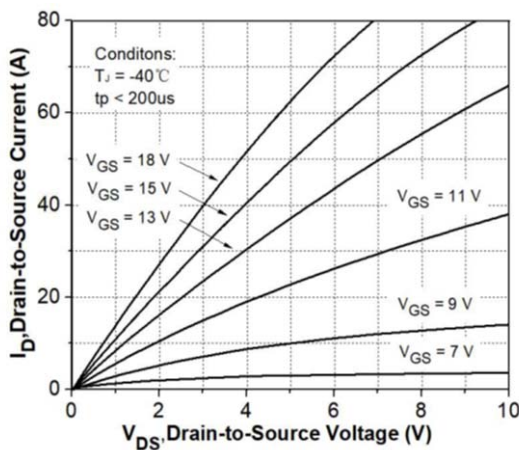

Fig 2. Output Characteristic ( $T_J=25^{\circ}C$ )

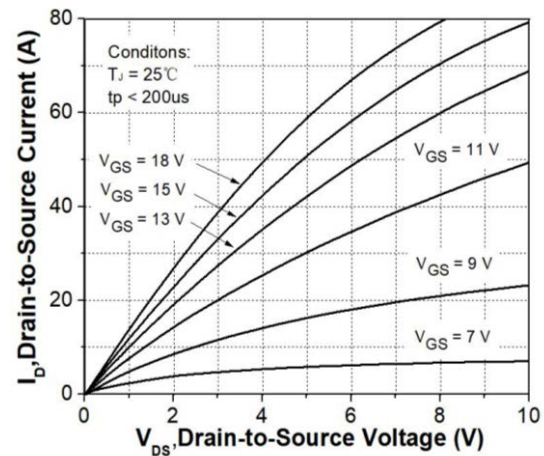

Fig 3. Output Characteristic ( $T_J=175^{\circ}C$ )

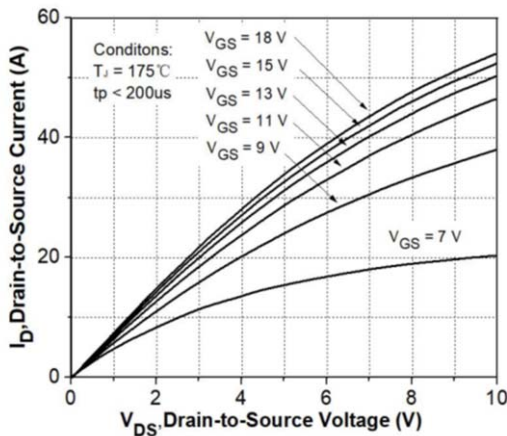

Fig 4:  $R_{ds(on)}$  Vs  $I_{ds}$  Characteristic

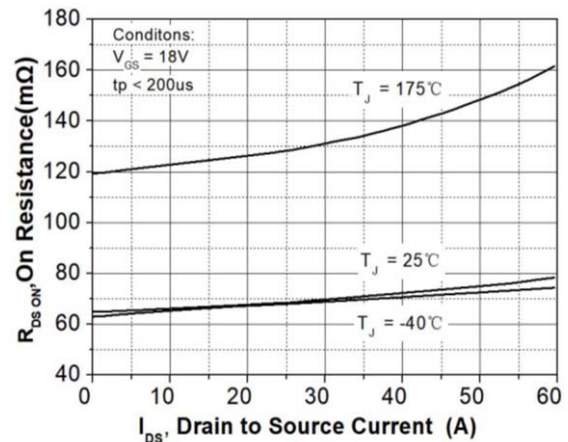



Fig 5: Rds(on) vs. Temperature

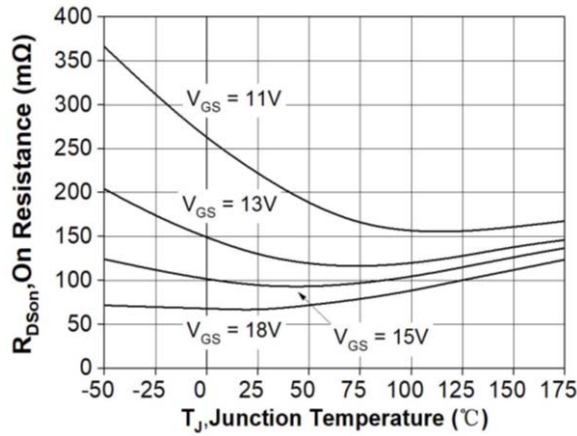

Fig 6: Transfer Characteristic

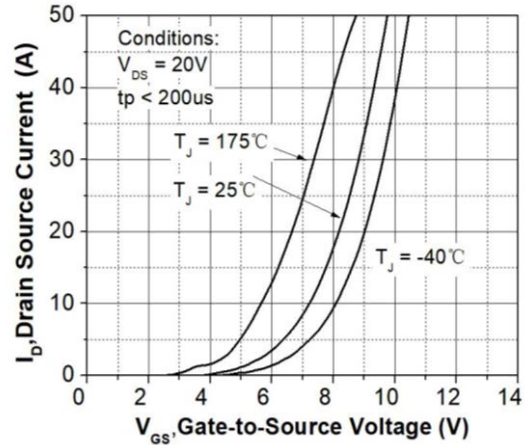

Fig 7: Body-diode Characteristic ( $T_J = -40^\circ C$ )

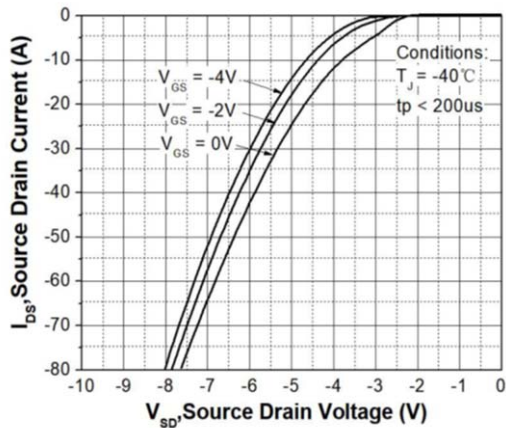

Fig 8: Body-diode Characteristic ( $T_J = 25^\circ C$ )

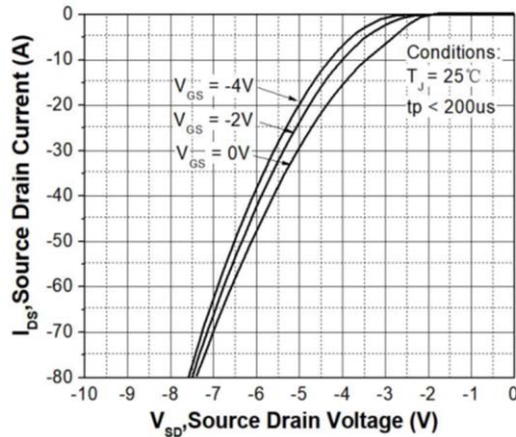

Fig 9: Body-diode Characteristic ( $T_J = 175^\circ C$ )

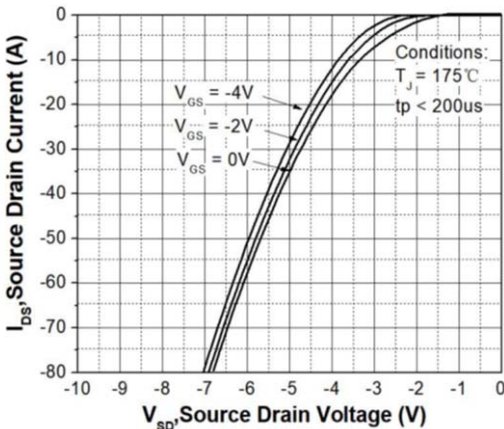

Fig 10:  $V_{TH}$  Vs  $T_J$  Temperature Characteristic

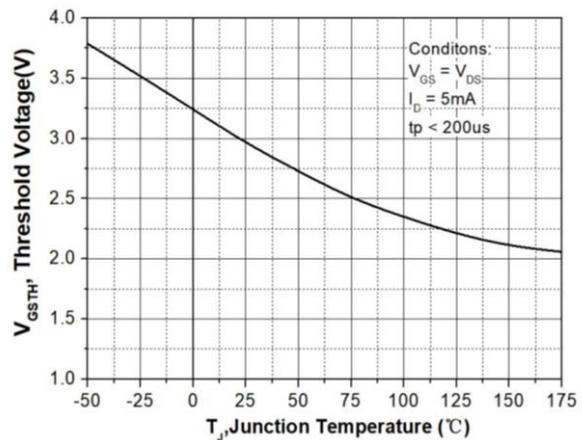



Fig 11: Gate Charge Characteristics

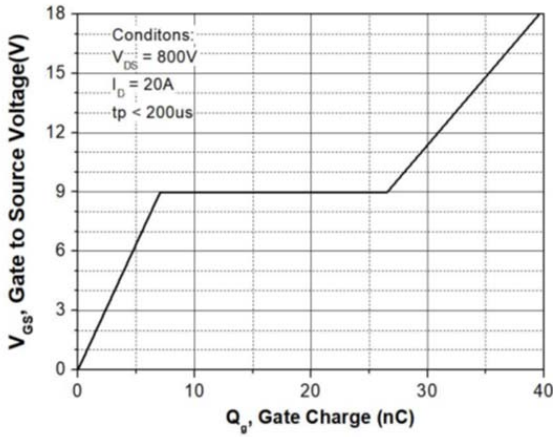

Fig 12: 3rd Quadrant Characteristic( $T_J = -40^\circ C$ )

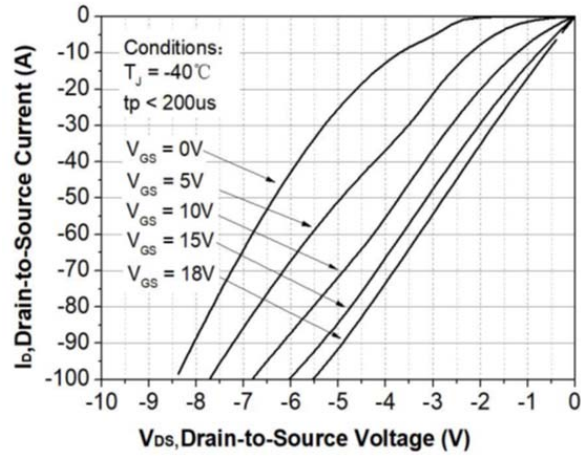

Fig 13: 3rd Quadrant Characteristic( $T_J = 25^\circ C$ )

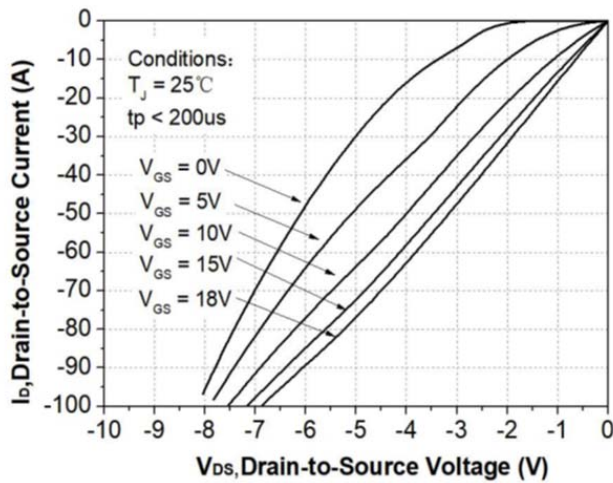

Fig 14: 3rd Quadrant Characteristic( $T_J = 175^\circ C$ )

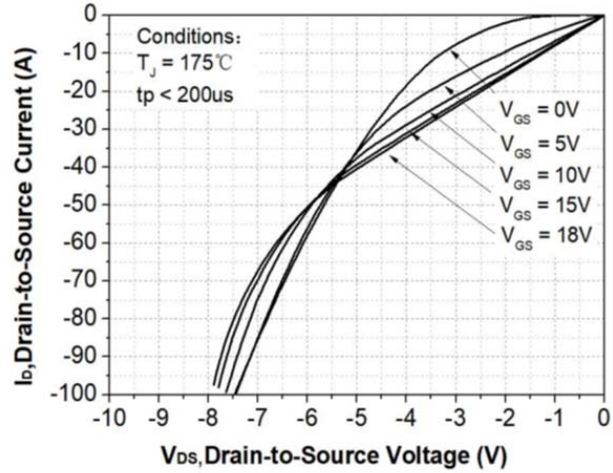

Fig 15: Capacitance Characteristic

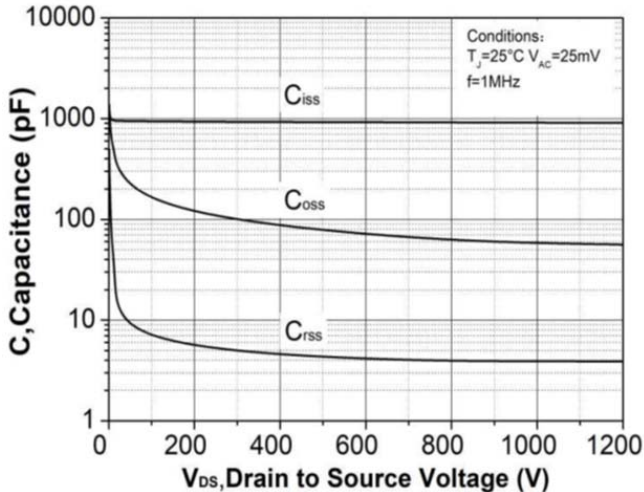

Fig 16: Safe Operating Area

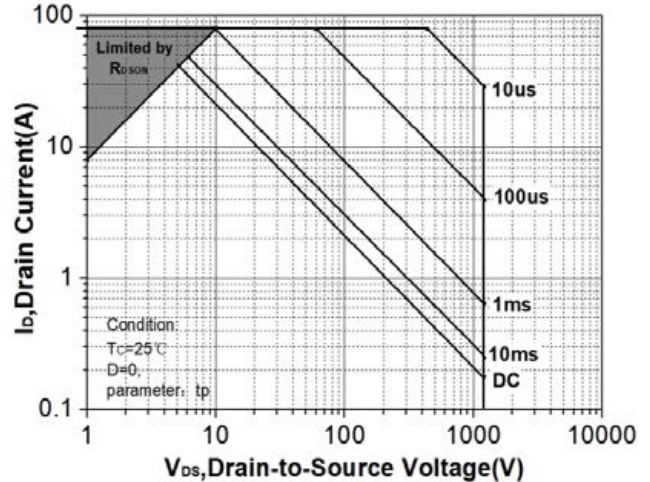
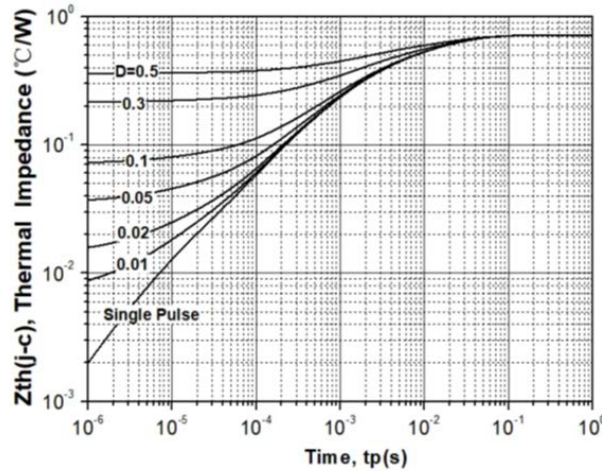



Fig 17: Transient Thermal Impedance



### Test Circuit & Waveform

Figure A. Definition of switching times

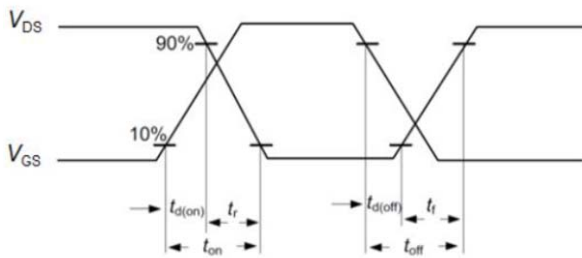

Figure B. Dynamic test circuit

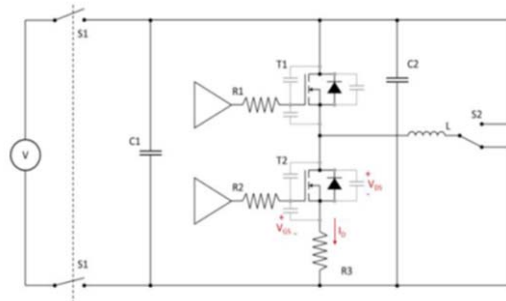

Figure C. Definition of body diodeswitching characteristics

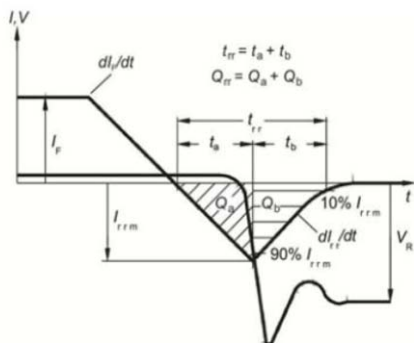
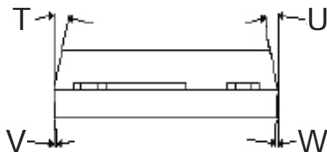
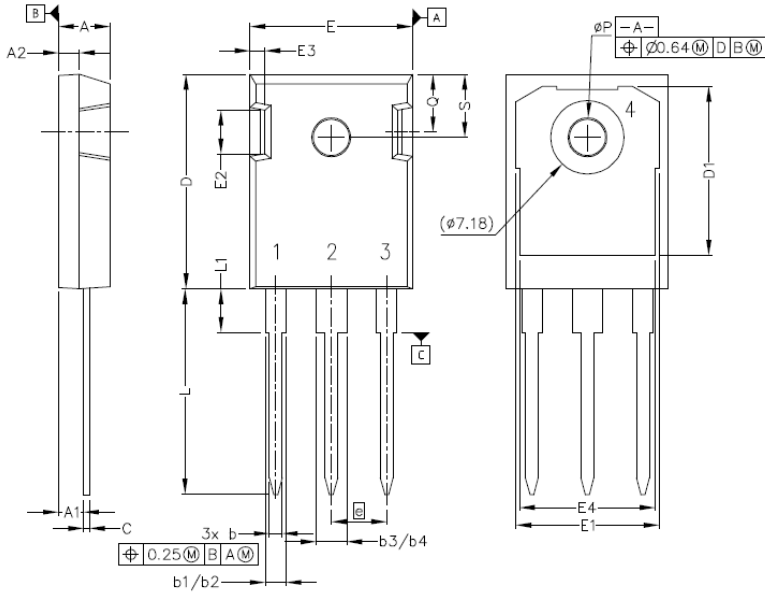

Figure C. Definition of diode switching characteristics



## Package Dimensions

### Package TO-247



#### Pinout Information:

- Pin 1 = Gate
- Pin 2, 4 = Drain
- Pin 3 = Source

| POS | Inches   |      | Millimeters |       |
|-----|----------|------|-------------|-------|
|     | Min      | Max  | Min         | Max   |
| A   | .190     | .205 | 4.83        | 5.21  |
| A1  | .090     | .100 | 2.29        | 2.54  |
| A2  | .075     | .085 | 1.91        | 2.16  |
| b   | .042     | .052 | 1.07        | 1.33  |
| b1  | .075     | .095 | 1.91        | 2.41  |
| b2  | .075     | .085 | 1.91        | 2.16  |
| b3  | .113     | .133 | 2.87        | 3.38  |
| b4  | .113     | .123 | 2.87        | 3.13  |
| c   | .022     | .027 | 0.55        | 0.68  |
| D   | .819     | .831 | 20.80       | 21.10 |
| D1  | .640     | .695 | 16.25       | 17.65 |
| D2  | .037     | .049 | 0.95        | 1.25  |
| E   | .620     | .635 | 15.75       | 16.13 |
| E1  | .516     | .557 | 13.10       | 14.15 |
| E2  | .145     | .201 | 3.68        | 5.10  |
| E3  | .039     | .075 | 1.00        | 1.90  |
| E4  | .487     | .529 | 12.38       | 13.43 |
| e   | .214 BSC |      | 5.44 BSC    |       |
| N   | 3        |      | 3           |       |
| L   | .780     | .800 | 19.81       | 20.32 |
| L1  | .161     | .173 | 4.10        | 4.40  |
| ØP  | .138     | .144 | 3.51        | 3.65  |
| Q   | .216     | .236 | 5.49        | 6.00  |
| S   | .238     | .248 | 6.04        | 6.30  |
| T   | 9°       | 11°  | 9°          | 11°   |
| U   | 9°       | 11°  | 9°          | 11°   |
| V   | 2°       | 8°   | 2°          | 8°    |
| W   | 2°       | 8°   | 2°          | 8°    |

### Recommended Solder Pad Layout

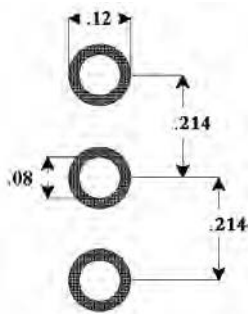

TO-247



### **Attention**

- Any and all HUA XUAN YANG ELECTRONICS products described or contained herein do not have specifications that can handle applications that require extremely high levels of reliability, such as life-support systems, aircraft's control systems, or other applications whose failure can be reasonably expected to result in serious physical and/or material damage. Consult with your HUA XUAN YANG ELECTRONICS representative nearest you before using any HUA XUAN YANG ELECTRONICS products described or contained herein in such applications.
  
- HUA XUAN YANG ELECTRONICS assumes no responsibility for equipment failures that result from using products at values that exceed, even momentarily, rated values (such as maximum ratings, operating condition ranges, or other parameters) listed in products specifications of any and all HUA XUAN YANG ELECTRONICS products described or contained herein.
  
- Specifications of any and all HUA XUAN YANG ELECTRONICS products described or contained herein stipulate the performance, characteristics, and functions of the described products in the independent state, and are not guarantees of the performance, characteristics, and functions of the described products as mounted in the customer's products or equipment. To verify symptoms and states that cannot be evaluated in an independent device, the customer should always evaluate and test devices mounted in the customer's products or equipment.
  
- HUA XUAN YANG ELECTRONICS CO.,LTD. strives to supply high-quality high-reliability products. However, any and all semiconductor products fail with some probability. It is possible that these probabilistic failures could give rise to accidents or events that could endanger human lives, that could give rise to smoke or fire, or that could cause damage to other property. When designing equipment, adopt safety measures so that these kinds of accidents or events cannot occur. Such measures include but are not limited to protective circuits and error prevention circuits for safe design, redundant design, and structural design.
  
- In the event that any or all HUA XUAN YANG ELECTRONICS products(including technical data, services) described or contained herein are controlled under any of applicable local export control laws and regulations, such products must not be exported without obtaining the export license from the authorities concerned in accordance with the above law.
  
- No part of this publication may be reproduced or transmitted in any form or by any means, electronic or mechanical, including photocopying and recording, or any information storage or retrieval system, or otherwise, without the prior written permission of HUA XUAN YANG ELECTRONICS CO.,LTD.
  
- Information (including circuit diagrams and circuit parameters) herein is for example only ; it is not guaranteed for volume production. HUA XUAN YANG ELECTRONICS believes information herein is accurate and reliable, but no guarantees are made or implied regarding its use or any infringements of intellectual property rights or other rights of third parties.
  
- Any and all information described or contained herein are subject to change without notice due to product/technology improvement, etc. When designing equipment, refer to the "Delivery Specification" for the HUA XUAN YANG ELECTRONICS product that you intend to use.

## X-ON Electronics

Largest Supplier of Electrical and Electronic Components

*Click to view similar products for [SiC MOSFETs](#) category:*

*Click to view products by [HXY MOS](#) manufacturer:*

Other Similar products are found below :

[SCT055HU65G3AG](#) [ADR065N028AH](#) [SCT4036KRC15](#) [CI72N170SM](#) [HC1M40120J](#) [SCT2160KEGC11](#) [IMZ120R090M1H](#)  
[HC1M320120D](#) [HC2M0045170P](#) [SC102N170T8L](#) [HC1M30065D](#) [HC1M60120D](#) [HC2M0650170D](#) [HC1M40120D](#) [SC060N065T8L](#)  
[SC015N065TCL](#) [SC013N120TCL](#) [SC021N120T8L](#) [SC032N120T8L](#) [YJD212080NCTG1](#) [YJD212040NCFG2](#) [SC015N065T8L](#)  
[SC160N120T8L](#) [SC075N120T8L](#) [HC1M15120S](#) [SCT3080ALGC11](#) [C3M0120100K](#) [C2M1000170J](#) [C3M0120090J](#) [C3M0065090J](#)  
[C3M0280090J](#) [SCT2750NYTB](#) [SCT2H12NYTB](#) [CDMS24783-120 SL](#) [C3M0016120K](#) [C3M0045065D](#) [C3M0045065K](#) [E3M0120090J](#)  
[C3M0120100J](#) [C3M0075120J](#) [DMWS120H100SM4](#) [DMWSH120H90SM4Q](#) [DMWSH120H28SM4Q](#) [DMWSH120H90SCT7](#)  
[DMWSH120H28SM3](#) [DMWSH120H28SM3Q](#) [DMWSH120H90SM3Q](#) [DIF065SIC020](#) [DIF120SIC022-AQ](#) [DIF065SIC030](#)