

■ 技术参数 SPECIFICATIONS

- 线数 (Poles) : 2~9
- 适用线规 (Applicable wires) : AWG24#~18#
- 适应基板厚度 (Applicable PC board thickness) : 1.6mm
- 温度范围 (Temperature range) : -25℃~85℃
- 额定电压 (Voltage rating) : 250V.Ac/Dc
- 额定电流 (Current rating) : 7A
- 接触电阻 (Contact resistance) : ≤0.015Ω
- 绝缘电阻 (Insulation resistance) : ≥1000MΩ
- 耐压 (Withstand voltage) : 1500V.Ac/1min
- 材料 (Material) :
 - 孔座 (Housing) : 尼龙 (PA66) UL94V-2(0)
 - 针座 (Wafer) : 尼龙 (PA66) UL94V-2(0)
 - 端子 (Terminal) : 磷青铜 (Phos.bronze Tin/plated)

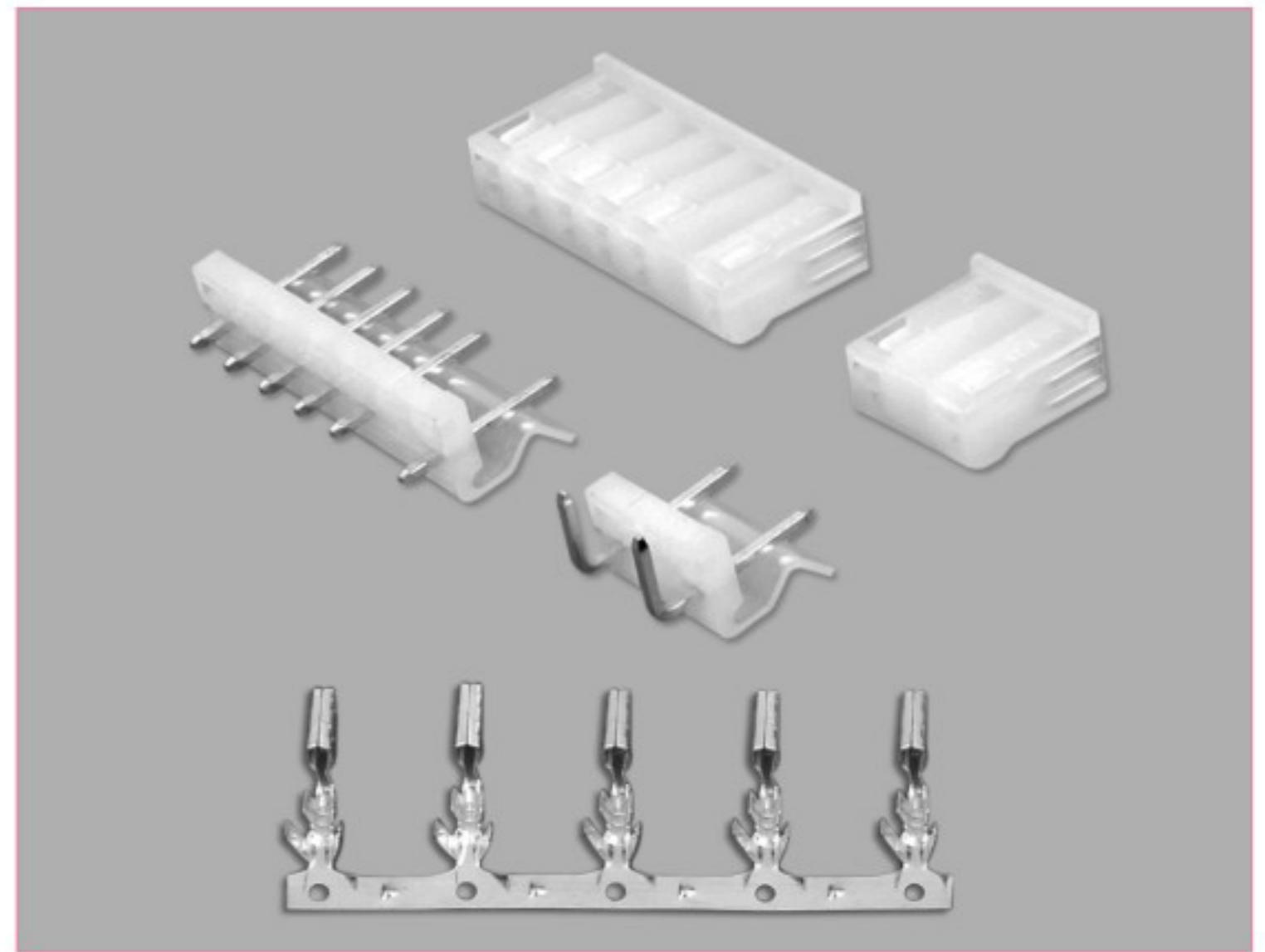

端子 TERMINAL (5225、5194)

型号 Type	适用线规 Applicable wires		电线外径 O.D of wire ins mm	数量 Quantity
	mm ²	AWG#		
HX39606-PT	0.2~0.75	24~18	1.5~2.8	3500PCS/盘

HX39606-PT (5225、5194)

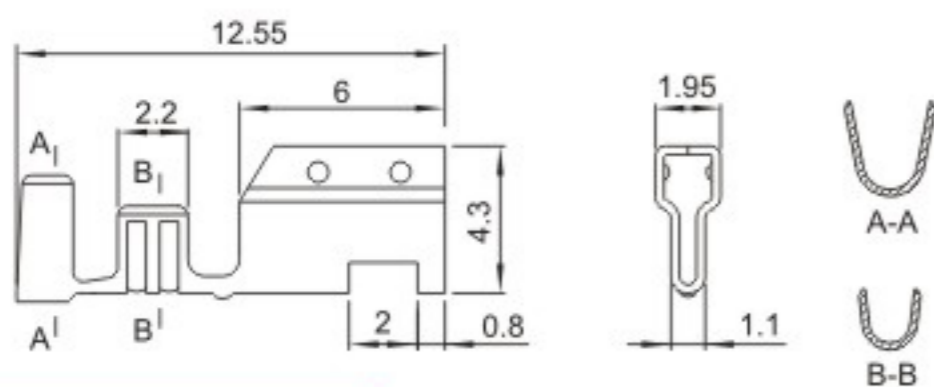

HX50808-Y (5198)

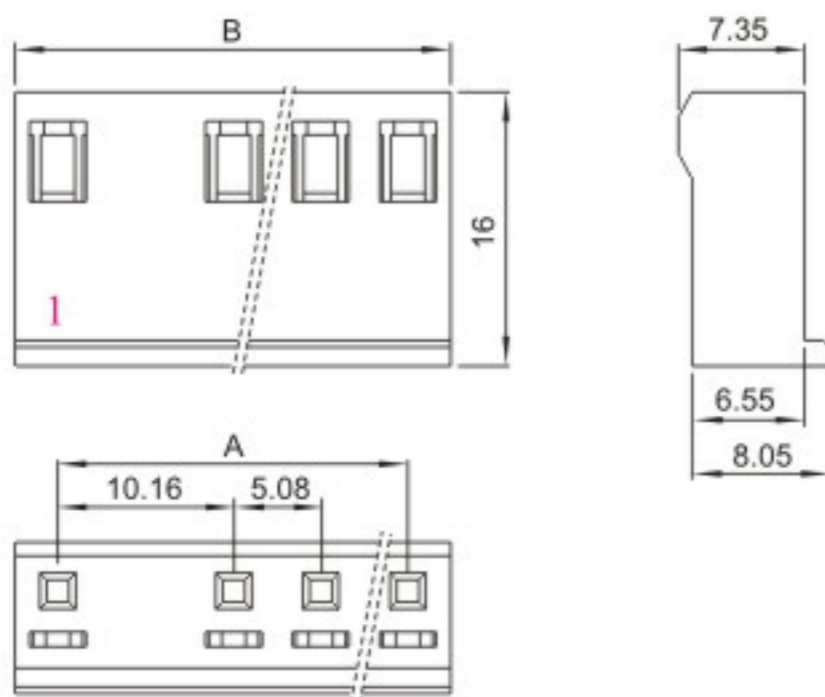

HX50808-NA (5283/5198)

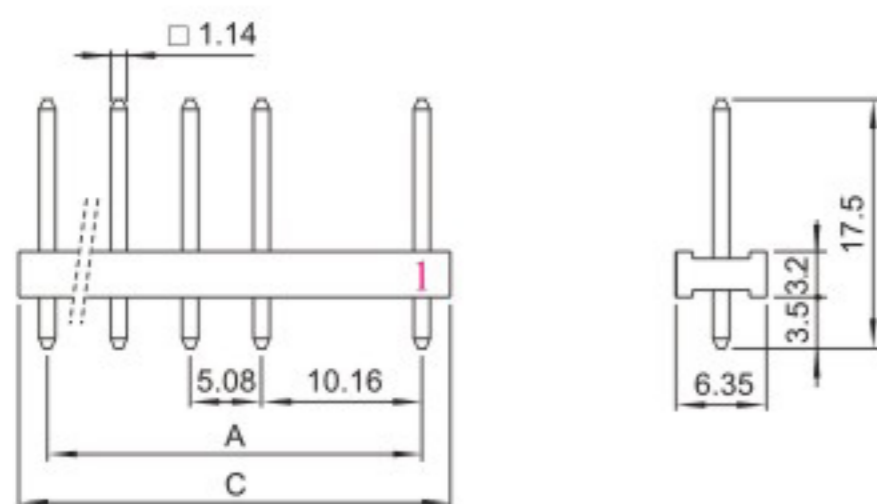

HX50808-A (5285/5198)

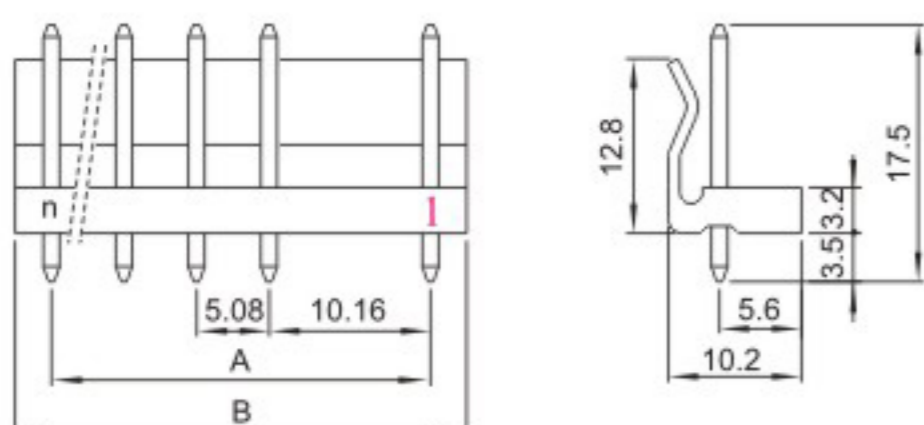

HX50808-WAP (5285/5198)

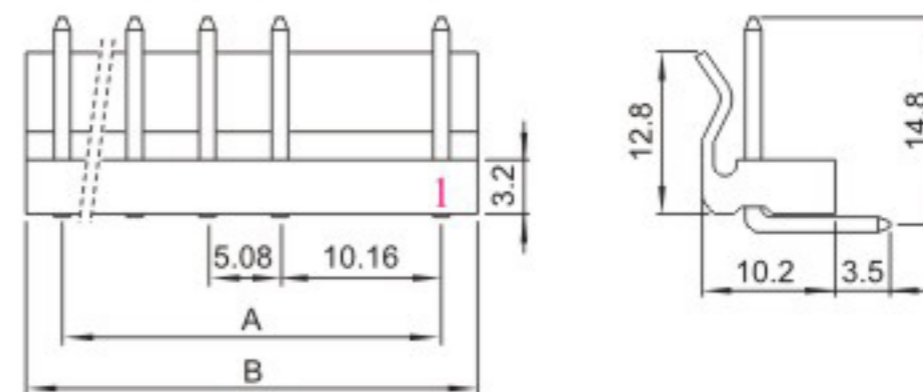

HX50808-WAG (5285/5198)

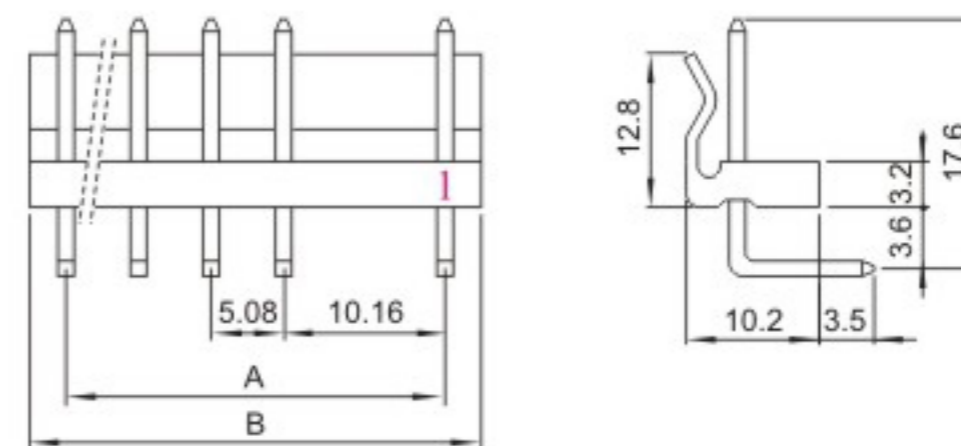

注: 5198-A针座=5.08-A空第二针(如5198-3A=5.08-4A3针空2)

■ 安装尺寸 MOUNTING MEASUREMENT

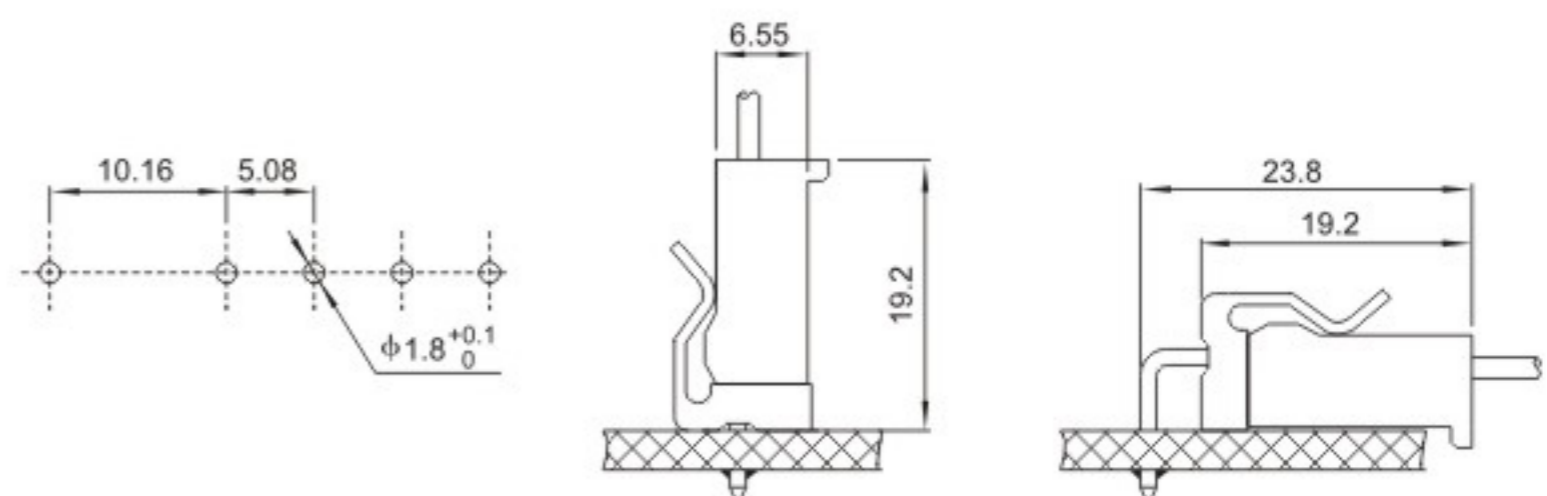

孔座 HOUSING (5198)

线数 Poles	型号 Type	尺寸Dimensions(mm)	
		A	B
2	HX50808-2Y	10.16	15.16
3	HX50808-3Y	15.24	20.24
4	HX50808-4Y	20.32	25.32
5	HX50808-5Y	25.40	30.40
6	HX50808-6Y	30.48	35.48
7	HX50808-7Y	35.56	40.56
8	HX50808-8Y	40.64	45.64
9	HX50808-9Y	45.72	50.72

针座 WAFER (5285/5283/5198)

线数 Poles	型号 Type	尺寸Dimensions(mm)			
		直式/弯式	横条(180°)	A	B
2	HX50808-2A/WA	HX50808-2NA	10.16	15.24	14.16
3	HX50808-3A/WA	HX50808-3NA	15.24	20.32	19.24
4	HX50808-4A/WA	HX50808-4NA	20.32	25.40	24.32
5	HX50808-5A/WA	HX50808-5NA	25.40	30.48	29.40
6	HX50808-6A/WA	HX50808-6NA	30.48	35.56	34.48
7	HX50808-7A/WA	HX50808-7NA	35.56	40.64	39.56
8	HX50808-8A/WA	HX50808-8NA	40.64	45.72	44.64
9	HX50808-9A/WA	HX50808-9NA	45.72	50.80	49.72

X-ON Electronics

Largest Supplier of Electrical and Electronic Components

Click to view similar products for [Headers & Wire Housings](#) category:

Click to view products by [Hongxing](#) manufacturer:

Other Similar products are found below :

[57102-F02-18ULF](#) [58102-G61-06LF](#) [0009485154](#) [009176003701906](#) [0050291907](#) [02.125.8002.8](#) [609-3404](#) [61062-3](#) [622-0430](#) [622-3653LF](#)
[63453-116](#) [636-1030](#) [636-1427](#) [636-3427](#) [636-4007](#) [641938-9](#) [644827-2](#) [65495-038](#) [65692-001LF](#) [65781-018](#) [65781-047](#) [65817-010LF](#)
[65817-015LF](#) [66207-023LF](#) [67016-026LF](#) [67095-007LF](#) [68631-112](#) [68645-018](#) [68648-049](#) [699319-000](#) [70.362.1628.0](#) [70-4210](#) [70-4226B](#)
[70-4853B](#) [707-5020](#) [707-5028](#) [71.350.2428.0](#) [71961-016LF](#) [733-134](#) [754199-000](#) [760-3052](#) [787-8014-00](#) [FCN-367T-T012/H](#) [80.063.4001.1](#)
[800-90-001-10-001000](#) [800-90-010-10-002000](#) [801-43-002-10-013000](#) [801-43-006-10-002000](#) [803-41-018-10-001000](#) [803-43-014-20-001000](#)