

标记 MARK	ECN编号/变更内容 ECN NO/DEFINITION					修改 REVISE		日期 DATE		核准 APPROVE	
PIN	DIM A	DIM B	PIN	DIM A	DIM B	PIN	DIM A	DIM B	PIN	DIM A	DIM B
1	—	—	11	12.70	13.97	21	25.40	26.67	31	38.10	39.37
2	1.27	2.54	12	13.97	15.24	22	26.67	27.94	32	39.37	40.64
3	2.54	3.81	13	15.24	16.51	23	27.94	29.21	33	40.64	41.91
4	3.81	5.08	14	16.51	17.78	24	29.21	30.48	34	41.91	43.18
5	5.08	6.35	15	17.78	19.05	25	30.48	31.75	35	43.18	44.45
6	6.35	7.62	16	19.05	20.32	26	31.75	33.02	36	44.45	45.72
7	7.62	8.89	17	20.32	21.59	27	33.02	34.29	37	45.72	46.99
8	8.89	10.16	18	21.59	22.86	28	34.29	35.56	38	46.99	48.26
9	10.16	11.43	19	22.86	24.13	29	35.56	36.83	39	48.26	49.53
10	11.43	12.70	20	24.13	25.40	30	36.83	38.10	40	49.53	50.80

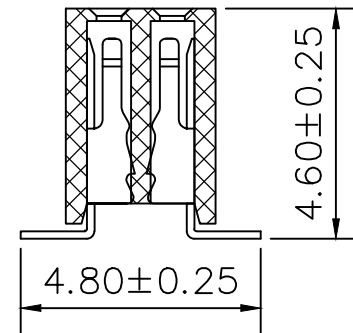

SPECIFICATIONS
 Current Rating: 1.0 Amps
 Withstanding Voltage: AC 500V
 Insulation Resistance: 1000MΩ Min
 Contact Resistance: 20mΩ Max
 Operation Temperature: -40°to+105°
 Insulator Material: Polyester
 Contact Material: Phosphor bronze
 Standard: PA6T
 Contact Plating: Gold Flash
 Max.Processing Temp: 200°C for 30-60seconds
 (255°C for 5seconds)

H	PC	PB
4.3	4.8	4.6

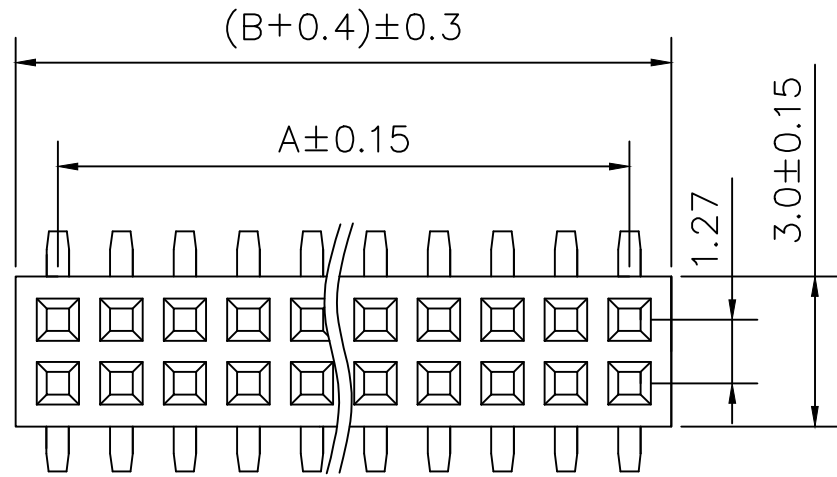
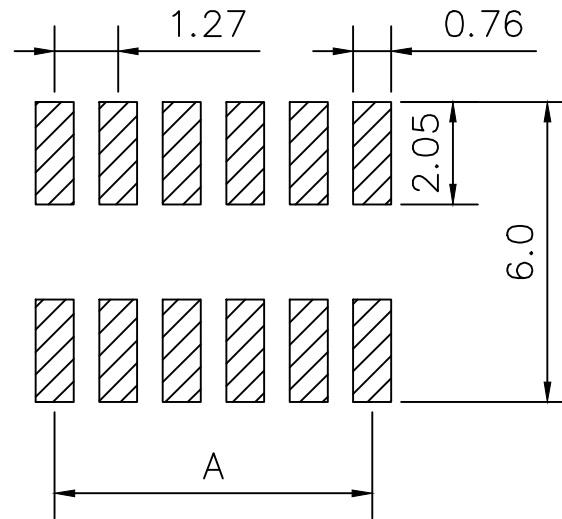
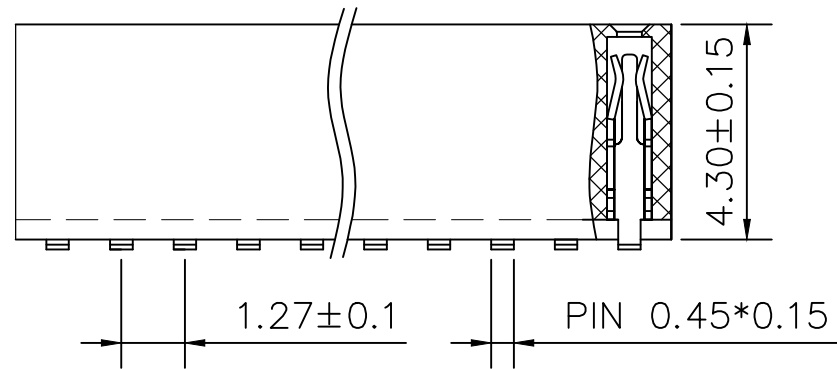

RECOMMEND P. C. B LAYOUT
 PCB TOLERANCE: ±0.05 (TOP VIEW)

2	接触	铜	镀金	
1	基座	PA6T	本色	
序号	品名	材质	电镀/颜色	备注

	深圳市虹成电子有限公司		品名 TITLE	排母	
			料号 PART NO	HC-PM127-4.3H-2x23PS	
一般公差 TOLERANCE		比列 SCALE	1:1		
X : ±0.30	X° : ±5°	单位 UNIT	MM		
X.X : ±0.25	X.X° : ±1°	张数 PART NO	1 OF 1		
X.XX : ±0.20	X.XX° : ±0.5°	版本 REV	A	制图 DRAW	AhYe
			审核 CHECKED	夏操云	
			批准 APPROVE	赵亮亮	



X-ON Electronics

Largest Supplier of Electrical and Electronic Components

Click to view similar products for [Headers & Wire Housings](#) category:

Click to view products by [Hong Cheng](#) manufacturer:

Other Similar products are found below :

[892-18-020-10-001101](#) [0010894062](#) [0010977306](#) [0015477636](#) [0015917161](#) [0022104068](#) [0022121042](#) [0022155065](#) [0022281023](#) [57102-F02-18ULF](#) [PCN6B-10P-2.5DS](#) [58102-G61-06LF](#) [582553-1](#) [0015911208](#) [01.001.5753.1](#) [0022285048](#) [0050291907](#) [02.125.8002.8](#)
[CSU011177004](#) [622-0430](#) [63453-116](#) [636-1030](#) [636-1427](#) [636-3427](#) [636-4007](#) [641938-9](#) [65495-038](#) [65692-001LF](#) [65781-018](#) [65781-047](#)
[65817-010LF](#) [67095-007LF](#) [67601157](#) [68631-112](#) [68645-018](#) [699319-000](#) [70.362.1628.0](#) [70-4210](#) [70-4226B](#) [70-4853B](#) [707-5028](#)
[71.350.2428.0](#) [733-134](#) [733-162](#) [760-3052](#) [80.063.4001.1](#) [800-90-001-10-001000](#) [801-43-002-10-013000](#) [801-43-006-10-002000](#)
[803-43-024-10-001000](#)