

GT16 Series

Small Coaxial Cable Connector for Automotive Antenna

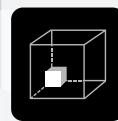

Antenna



Space Saving



3 GHz

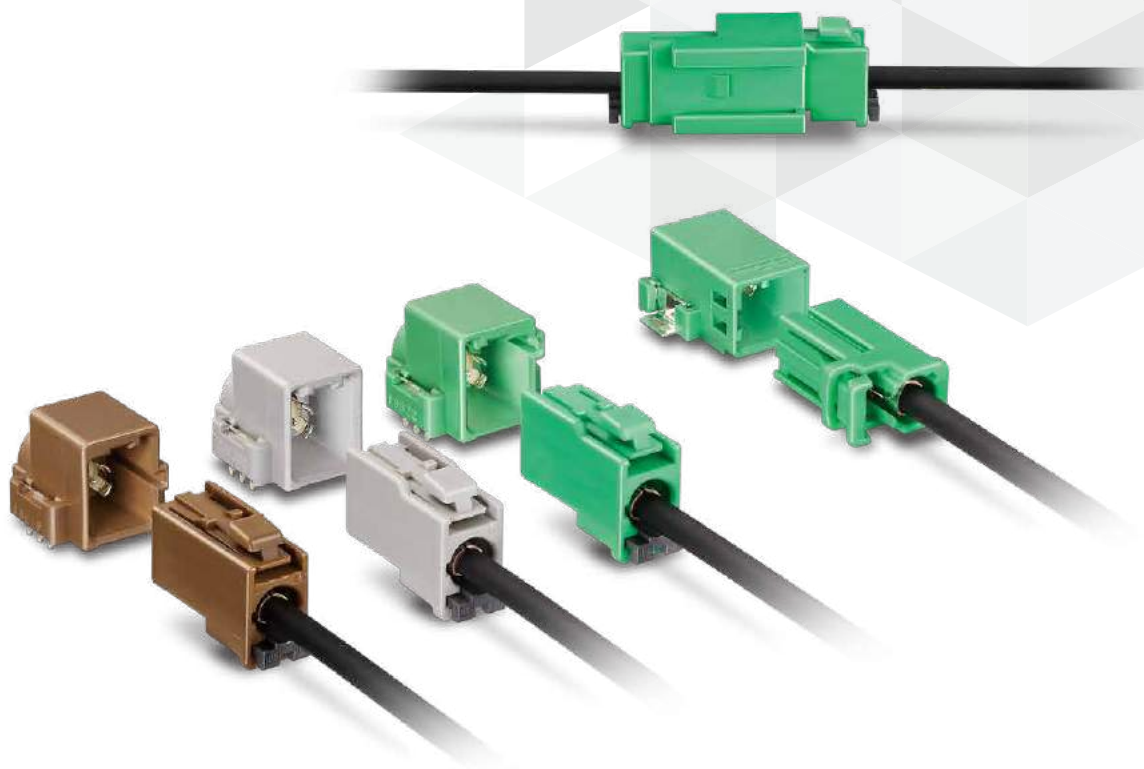

Apr. 1. 2024 Copyright 2024 HIROSE ELECTRIC CO., LTD. All Rights Reserved.



Features

1. Space-saving Design
2. Compact and light compared to the HRS GT5 Series.
3. Superior High Frequency Performance : up to 3GHz

Applications

In-car communication, Automotive sensors (Temperature, Pressure, etc.), Automotive audio systems, GPS antenna systems, RACS antenna, Audio/Video antenna systems, Measuring instruments, Communication equipment, Office automation equipment, LAN systems, etc.

Product Specifications

Rated Current	1A	Operating Temperature (Note 1)	-40 to +105°C
Rated Voltage	250V AC		

Items	Specifications	Conditions
Contact Resistance	30m Ω Max.	Measured at 1A DC
Insulation Resistance	100M Ω Min.	Measured at 500V DC
Withstanding Voltage	No insulation breakdown	650V AC for 1 min.
Mating Durability	Contact Resistance : 60m Ω Max.	30 Insertion/Extraction cycles

Note : Includes temperature rise due to current flow.

High Frequency Characteristics (V.S.W.R.)

TEST DATA (Using 1.5D-2W cable)

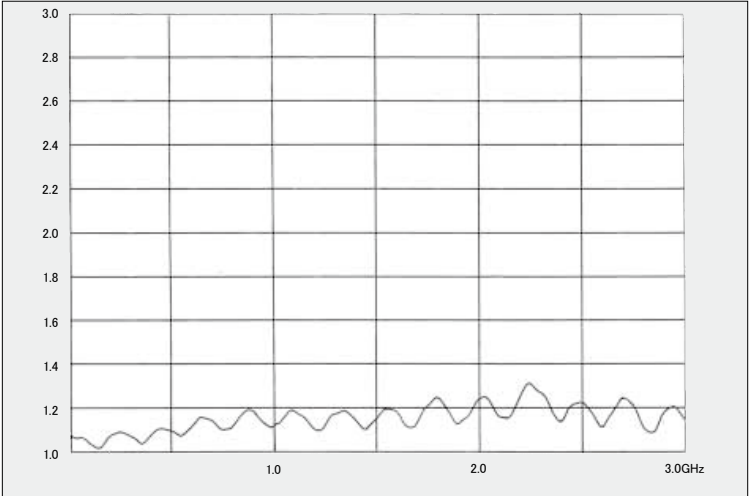

Note : Typical data using fully assembled and connected GT16C-1P-H and the GT16C-1S-HU.

Mating Combinations

Type	Plug	Receptacle, In-line Jack
Without Retainer	GT16F-1S-HU(A)	GT16F-1P-H(A)(55)
		GT16F-1P-HU(A)
	GT16F-1S-HU(B)	GT16F-1P-H(B)(55)
		GT16F-1P-HU(B)
With Retainer	GT16C-1S-HU	GT16C-1P-H(55)
		GT16C-1PP-HU
	GT16C-1S-HU(A)	GT16C-1P-H(A)(55)
		GT16C-1PP-HU(A)
	GT16C-1S-HU(B)	GT16C-1P-H(B)(55)
		GT16C-1PP-HU(B)

GT16F Plug

The product consists of four parts.
(Housing, Insulation Case, Outer Terminal and Center Terminal)

Without Retainer



● Housing

Part No.	HRS No.	Material	Color	Mating Key	Purchase Unit
GT16F-1S-HU(A)	CL0766-0082-4-00	PBT	Brown	A Key	100pcs per bag
GT16F-1S-HU(B)	CL0766-0083-7-00		Green	B Key	

● Insulation Case

Part No.	HRS No.	Material	Color	Purchase Unit
GT16-SC	CL0766-0002-5-00	PBT	White	100pcs per bag

● Outer Terminal

Part No.	HRS No.	Material / Finish	Insulation Outer Diameter	Jacket Outer Diameter	Purchase Unit
GT16-/1.6-2.9SC	CL0766-0003-8-00	Phosphor Bronze / Tin Plating	φ 1.5 to 2.0	φ 2.6 to 3.4	100pcs per bag
GT16-/0.7-1.5SC	CL0766-0056-4-00		φ 0.6 to 0.9	φ 1.4 to 1.8	

● Center Terminal

Part No.	HRS No.	Material / Finish	Wire Size	Purchase Unit
GT16-2428SCF	CL0766-0001-2-00	Phosphor Bronze / Tin Plating	24 to 28 AWG	10,000pcs per reel
GT16-30SCF	CL0766-0055-1-00		30 AWG	

GT16F Receptacle

SMT Type

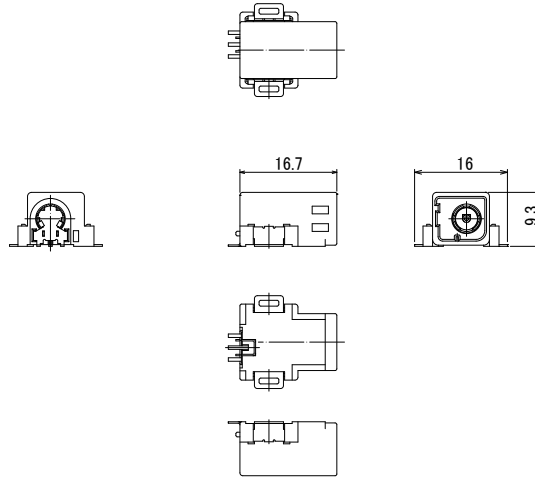

Part No.	HRS No.	Material / Finish	Color	Mating Key	Purchase Unit
GT16F-1P-H(A)(55)	CL0766-0078-7-55	Housing : PPS	Brown	A Key	72pcs per tray
GT16F-1P-H(B)(55)	CL0766-0079-0-55	Center Terminal : Phosphor Bronze / Tin Plating Outer Terminal : Phosphor Bronze / Tin Plating Insulator : PPS / Natural Shield Plate : Phosphor Bronze / Tin Plating Retention Tab : Brass / Tin Plating	Green	B Key	

GT16F In-line Jack

The product consists of four parts.
(Housing, Insulation Case, Outer Terminal and Center Terminal)

Without Retainer

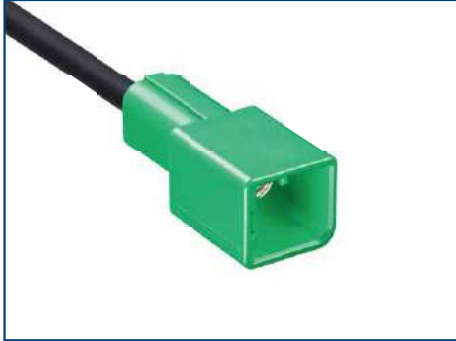

● Housing

Part No.	HRS No.	Material	Color	Mating Key	Purchase Unit
GT16F-1P-HU(A)	CL0766-0086-5-00	PBT	Brown	A Key	100pcs per bag
GT16F-1P-HU(B)	CL0766-0087-8-00		Green	B Key	

● Insulation Case

Part No.	HRS No.	Material	Color	Purchase Unit
GT16-PC	CL0766-0007-9-00	PBT	White	100pcs per bag

● Outer Terminal

Part No.	HRS No.	Material / Finish	Insulation Outer Diameter	Jacket Outer Diameter	Purchase Unit
GT16C-/1.6-2.9PC	CL0766-0019-8-00	Phosphor Bronze / Tin Plating	ϕ 1.5 to 2.0	ϕ 2.6 to 3.4	100pcs per bag
GT16C-/0.7-1.5PC	CL0766-0018-5-00		ϕ 0.6 to 0.9	ϕ 1.4 to 1.8	

● Center Terminal

Part No.	HRS No.	Material / Finish	Wire Size	Purchase Unit
GT16-2428PCF	CL0766-0006-6-00	Brass / Tin Plating	24 to 28 AWG	10,000pcs per reel
GT16-30PCF	CL0766-0015-7-00		30 AWG	

GT16C Plug

The product consists of five parts.
(Housing, Insulation Case, Outer Terminal, Retainer and Center Terminal)

With Retainer



● Housing

Part No.	HRS No.	Material	Color	Mating Key	Purchase Unit
GT16C-1S-HU	CL0766-0010-3-00	PBT	Light Gray	Standard	100pcs per bag
GT16C-1S-HU(A)	CL0766-0060-1-00		Brown	A Key	
GT16C-1S-HU(B)	CL0766-0061-4-00		Green	B Key	

● Insulation Case

Part No.	HRS No.	Material	Color	Purchase Unit
GT16-SC	CL0766-0002-5-00	PBT	White	100pcs per bag

● Outer Terminal

Part No.	HRS No.	Material / Finish	Insulation Outer Diameter	Jacket Outer Diameter	Purchase Unit
GT16C-/1.6-2.9SC	CL0766-0012-9-00	Phosphor Bronze / Tin Plating	ϕ 1.5 to 2.0	ϕ 2.6 to 3.4	100pcs per bag
GT16C-/0.7-1.5SC	CL0766-0057-7-00		ϕ 0.6 to 0.9	ϕ 1.4 to 1.8	

● Retainer

Part No.	HRS No.	Material	Color	Purchase Unit
GT16C-1P/S-R	CL0766-0011-6-00	PBT	Dark Gray	100pcs per bag

● Center Terminal

Part No.	HRS No.	Material / Finish	Wire Size	Purchase Unit
GT16-2428SCF	CL0766-0001-2-00	Phosphor Bronze / Tin Plating	24 to 28 AWG	10,000pcs per reel
GT16-30SCF	CL0766-0055-1-00		30 AWG	

GT16C Receptacle

SMT+THR (Through Hole Reflow) Type

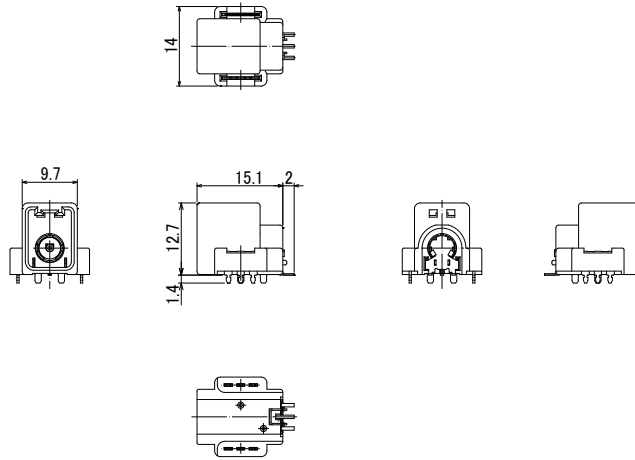

Part No.	HRS No.	Material / Finish	Color	Mating Key	Purchase Unit
GT16C-1P-H(55)	CL0766-0102-0-55	Housing : PPS	Light Gray	Standard	200pcs per reel
GT16C-1P-H(A)(55)	CL0766-0106-0-55	Center Terminal : Phosphor Bronze / Tin Plating Outer Terminal : Phosphor Bronze / Tin Plating	Brown	A Key	
GT16C-1P-H(B)(55)	CL0766-0107-3-55	Insulator : PPS / Natural Shield Plate : Phosphor Bronze / Tin Plating Retention Tab : Brass / Tin Plating	Green	B Key	

GT16C In-line Jack

The product consists of five parts.

(Housing, Insulation Case, Outer Terminal, Retainer and Center Terminal)

With Retainer



● Housing

Part No.	HRS No.	Material	Color	Mating Key	Purchase Unit
GT16C-1PP-HU	CL0766-0029-1-00	PBT	Light Gray	Standard	100pcs per bag
GT16C-1PP-HU(A)	CL0766-0064-2-00		Brown	A Key	
GT16C-1PP-HU(B)	CL0766-0065-5-00		Green	B Key	

● Insulation Case

Part No.	HRS No.	Material	Color	Purchase Unit
GT16-PC	CL0766-0007-9-00	PBT	White	100pcs per bag

● Outer Terminal

Part No.	HRS No.	Material / Finish	Insulation Outer Diameter	Jacket Outer Diameter	Purchase Unit
GT16C-/1.6-2.9PC	CL0766-0019-8-00	Phosphor Bronze / Tin Plating	ϕ 1.5 to 2.0	ϕ 2.6 to 3.4	100pcs per bag
GT16C-/0.7-1.5PC	CL0766-0018-5-00		ϕ 0.6 to 0.9	ϕ 1.4 to 1.8	

● Retainer

Part No.	HRS No.	Material	Color	Purchase Unit
GT16C-1P/S-R	CL0766-0011-6-00	PBT	Dark Gray	100pcs per bag

● Center Terminal

Part No.	HRS No.	Material / Finish	Wire Size	Purchase Unit
GT16-2428PCF	CL0766-0006-6-00	Brass / Tin Plating	24 to 28 AWG	10,000pcs per reel
GT16-30PCF	CL0766-0015-7-00		30 AWG	

Crimping Tools

Please ask your Hirose Electric representative for a user manual.

Automatic Crimping Machine



Product number CM-105C

Note 1 : Photo for reference only. Subject to change.

Note 2 : Please refer to the table below for applicator part numbers.

Specifications

Item	Specifications	Remarks
Press Capacity	1.5ton	-
Stroke Length	30mm	-
Number of Strokes	200spm (50Hz)	240spm (60Hz)
Weight	75kg	-
Motor	0.2kw	100V AC
Crimping Speed	2,000 to 4,000pcs/H	-

Applicator (for Mounting to Automatic Crimping Machines)

Terminal Part No.	Terminal HRS No.	Applicator Part No.	Applicator HRS No.
GT16-2428SCF	CL0766-0001-2-00	AP105-GT16-2428	CL0901-5108-4-00
GT16-2428PCF	CL0766-0006-6-00		
GT16-30SCF	CL0766-0055-1-00	AP105-GT16-30	CL0901-5124-0-00
GT16-30PCF	CL0766-0015-7-00		

Note 1 : Different contact crimp heights are available for different cable types.

Please contact your Hirose Electric account representative for details.

Other cables will require different crimp height settings. Please note that this may take a few days.

Note 2 : When purchasing HRS equipment, please contact your Hirose Electric account representative to confirm that the cable that you plan to use for the applicable terminal has been evaluated.

Note 3 : The applicators and tools listed here may not be applicable depending on the specifications of the cable you use.

Hand Press

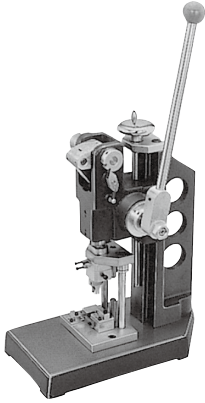

Product number HOS-7

Outer Terminal Caulking Tool (for Mounting Hand Press)

Terminal Part No.	Terminal HRS No.	Outer Terminal Caulking Tool Part No.	Outer Terminal Caulking Tool HRS No.
GT16-/1.6-2.9SC	CL0766-0003-8-00	GT16-1.6-2.9/CK-MP	CL0902-5058-4-00
GT16C-/1.6-2.9SC	CL0766-0012-9-00		
GT16C-/1.6-2.9PC	CL0766-0019-8-00		
GT16-/0.7-1.5SC	CL0766-0056-4-00	GT16-0.7-1.5/CK-MP	CL0902-5064-7-00
GT16C-/0.7-1.5SC	CL0766-0057-7-00		
GT16C-/0.7-1.5PC	CL0766-0018-5-00		

Note 1 : Different contact crimp heights are available for different cable types.

Please contact your Hirose Electric account representative for details.

Please note that we will need to define new crimp heights for novel cables and this may take a few days.

Note 2 : When purchasing HRS equipment, please contact your Hirose Electric account representative to confirm that the cable that you plan to use for the applicable terminal has been evaluated.

Note 3 : The applicators and tools listed here may not be applicable depending on the specifications of the cable you use.

While Taking into Consideration

Specifications mentioned in this catalog are reference values.

When considering to order or use this product, please review the Drawing and Product Specifications sheets.

Use an appropriate cable when using the connector in combination with cables.

If considering usage of a non-specified cable, please contact your sales representative.

If assembly process is done by jigs & tools which are not identified by Hirose, the warranty of the product may be affected.

If considering usage for below mentioned applications, please contact your sales representative.

In cases where the application will demand a high level of reliability, such as automotive, medical instruments, public infrastructure, aerospace/defense etc. Hirose must review before assurance of reliability can be given.

HIROSE



HIROSE ELECTRIC CO.,LTD.

2-6-3 Nakagawa Chuoh, Tsuzuki-Ku, Yokohama-Shi 224-8540, JAPAN
<https://www.hirose.com>

* The contents of this catalog are current as of date of 11/2023. Contents are subject to change without notice for the purpose of improvements.

* The HRS logo and "HIROSE" are trademarks of HIROSE ELECTRIC CO., LTD.

X-ON Electronics

Largest Supplier of Electrical and Electronic Components

Click to view similar products for [Automotive Connectors](#) category:

Click to view products by [Hirose](#) manufacturer:

Other Similar products are found below :

[72.330.1035.1](#) [776880-1](#) [827153-1](#) [9-1326729-8](#) [9-221607-5](#) [925474-1](#) [968782-1](#) [98891-1012](#) [98989-1011](#) [12004468](#) [12004475-L](#)
[12004483](#) [12033816](#) [12052466](#) [12066163](#) [12015909](#) [12077753](#) [12047958](#) [12084688](#) [12336-12](#) [12343-16-20](#) [13669373](#) [13681974](#)
[13688972](#) [13779834](#) [13796274](#) [13843152](#) [13581967](#) [13667961](#) [13669624](#) [13675513](#) [13753471](#) [13946876](#) [13955963](#) [13971791](#) [13979933](#)
[13797473](#) [13805590](#) [13888202](#) [1428188-1](#) [1437287-3](#) [1428188-2](#) [DS07-19S-5020](#) [1456987-7](#) [APD-7CP-H](#) [APK-SB25A10L](#) [1452931-2](#)
[15317331](#) [15326397](#) [15336198](#)