

SPECIFICATIONS

Current Rating: 3Amps
 Insulation Resistance: 1000MΩ Min
 Contact Resistance: 20mΩ Max
 Withstanding Voltage: AC 1000V
 Operation Temperature: -40° to +105°
 Contact Material: Brass
 Insulator Material: Polyester (UL 94V-0)
 Contact plating: Gold Flash
 Standard: PA6T
 Max. Processing Temp: 240° C for 30-60 seconds
 (260° C for 10 seconds)

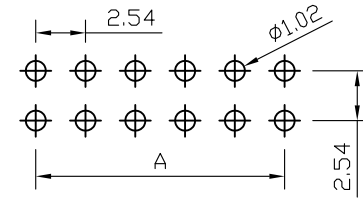
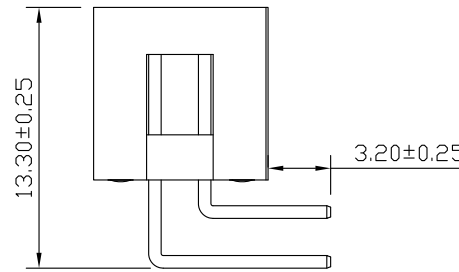
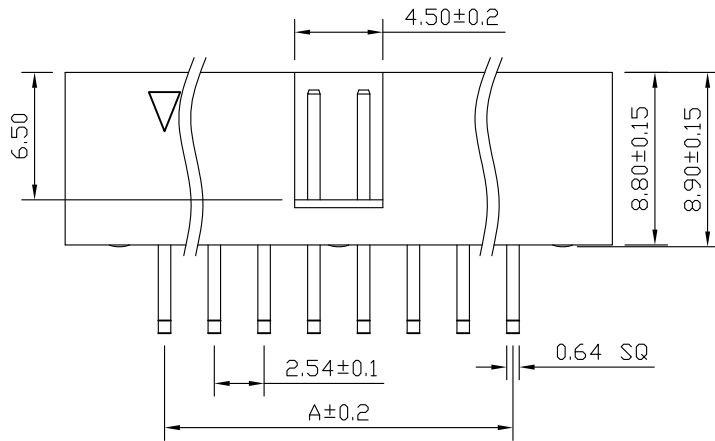
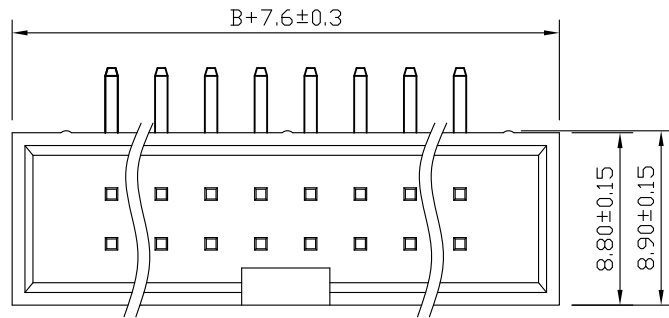

RECOMMEND P. C. B LAYOUT
 PCB TOLERANCE: ±0.05 (TOP VIEW)

韩下 深圳市韩下电子有限公司

No. of	DIM. A	DIM. B	No. of	DIM. A	DIM. B	No. of	DIM. A	DIM. B
6	5.08	7.62	20	22.86	25.40	36	43.18	45.72
8	7.62	10.16	24	27.94	30.48	40	48.26	50.80
10	10.16	12.70	26	30.48	33.02	44	53.34	55.88
12	12.70	15.24	28	33.02	35.56	50	60.96	63.50
14	15.24	17.78	30	35.56	38.10	60	73.66	76.20
16	17.78	20.32	32	38.10	40.64	64	78.74	81.28
18	20.32	22.86	34	40.64	43.18			

UNLESS OTHERWISE SPECIFIED TOLERANCE

X : ±0.30 X° : ±5°
 X.X : ±0.25 X.X° : ±1°
 X.XX : ±0.20 X.XX° : ±0.5°

DRAWN NAME:

HX JN2.54-2x9P WZ H8.9

SIZE	A4	SCALE	N:1	PROUCT NO.	
REV	A	UNIT	mm	PROJECT	⊕
				PAGE	1/1

DRAWN : 黄彬 2020.6.24 CHECKED : 张伟 2020.6.24 APPROVED : 罗小春 2020.6.24

X-ON Electronics

Largest Supplier of Electrical and Electronic Components

Click to view similar products for [Headers & Wire Housings](#) category:

Click to view products by [hanxia](#) manufacturer:

Other Similar products are found below :

[892-18-020-10-001101](#) [0010894062](#) [0010977306](#) [0015477636](#) [0015917161](#) [0022104068](#) [0022121042](#) [0022155065](#) [0022281023](#) [57102-F02-18ULF](#) [PCN6B-10P-2.5DS](#) [58102-G61-06LF](#) [582553-1](#) [0015911208](#) [01.001.5753.1](#) [0022285048](#) [0050291907](#) [02.125.8002.8](#)
[CSU011177004](#) [622-0430](#) [63453-116](#) [636-1030](#) [636-1427](#) [636-3427](#) [636-4007](#) [641938-9](#) [65495-038](#) [65692-001LF](#) [65781-018](#) [65781-047](#)
[65817-010LF](#) [67095-007LF](#) [67601157](#) [68631-112](#) [68645-018](#) [699319-000](#) [70.362.1628.0](#) [70-4210](#) [70-4226B](#) [70-4853B](#) [707-5028](#)
[71.350.2428.0](#) [733-134](#) [733-162](#) [760-3052](#) [80.063.4001.1](#) [800-90-001-10-001000](#) [801-43-002-10-013000](#) [801-43-006-10-002000](#)
[803-43-024-10-001000](#)