

REV.	ECN.	NO.	APPD.
A	HC961280	C. CHEN	09-06-'96
B	HC981629	Dick Lee	6/29'98
C	HC982138	Dick Lee	8/26'98
D	HC990798	Dick Lee	3/7'99
E	BC087032802	Jake.W.Yuan	
F	BC087079956	Jake.W.Yuan	
G	BC097127826	Yihsin Chen	

NOTE: UNLESS OTHERWISE SPECIFIED

1. DIMENSION SHALL BE INTERPRETED PER ASME Y14.5-2009.
2. ALL DIMENSIONS ARE IN MILLIMETERS WITH INCH EQUIVALENT SHOWN IN BRACKET.
3. MATERIAL OF ① AND ② ARE SHOWN ON DRAWING NO. 307-0700-030
4. HARMFUL MATERIAL PLEASE FOLLOWED FOXCONN'S DOC. "EP112".
5. THE CONCENTRATIONS OF Br&Cl CAN SATISFY THE REQUIREMENTS OF HALOGEN-FREE IN FOXCONN'S DOC "EP112".
6. PLEASE CONTACT FOXCONN SALES REPRESENTATIVE TO VERIFY PRODUCT DETAILS&AVAILABILITY

△ SJ052\*\*\_\*\*\*\*

SEE DWG. NO. 307-0700-030

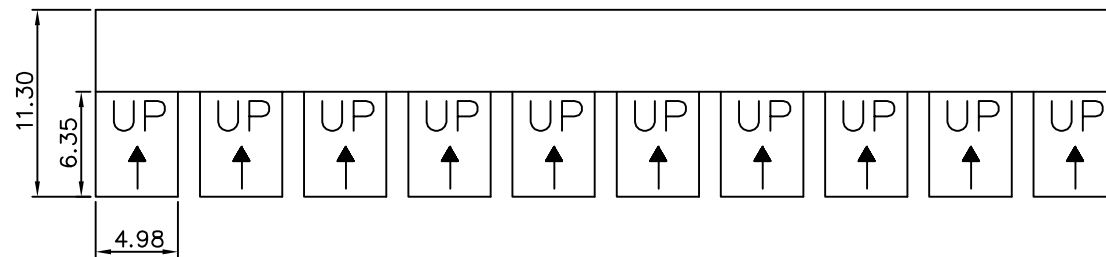
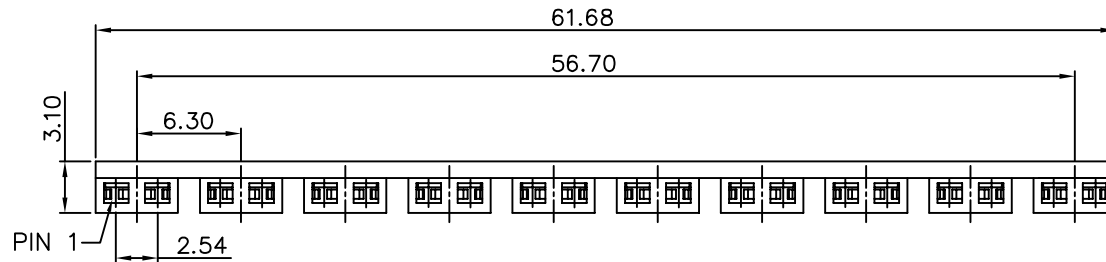

STRIP TYPE

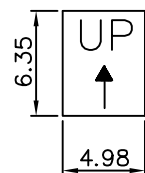
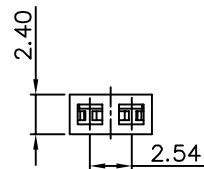
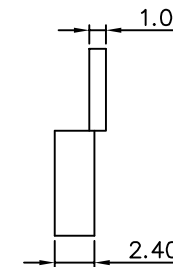

LOOSE TYPE

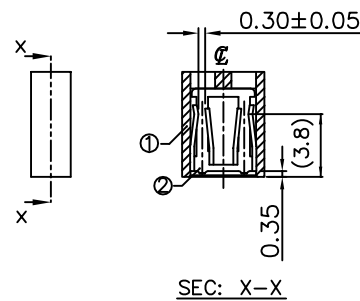

X.±	X°.±	UNITS mm	NAME(INTENDED USE)	<b>FOXCONN</b> HON HAI PRECISION IND. CO.,LTD. TAIPEI, TAIWAN, R.O.C.
.X± 0.25	.X°.±	MAT'L	JUMPER CONN.	
.XX± 0.13	.XX°.±	FINISH	PART NO.(INTENDED USE)	TITLE:
.XXX±	.XXX°.±		SJ05 SERIES	CUSTOMER DRAWING
THESE DRAWINGS AND SPECIFICATIONS ARE THE PROPERTY OF HON HAI PRECISION IND. CO., LTD. AND SHALL NOT BE REPRODUCED, COPIED OR USED IN ANY MANNER WITHOUT THE PRIOR WRITTEN CONSENT OF HON HAI PRECISION IND. CO., LTD.			APPD: Yihsin Chen	DWG NO.:
			Q'TY	CHKD: Max S.H. Yang
			DR: Yuke Chen 11/19'09	SCALE SHEET REV.
				N/A 1/1 G

△ SJ052\*\*\_\*\*\*\*  
PART NO.

REV.	ECN NO.	APPD.
A	HC961280	C.CHEN 9/6'96
B	HC98746	DICK LEE 3/26'98
C	HC981629	DICK LEE 6/29'98
D	HC990797	DICK LEE 3/11'99
E	IC021132	YIHSIN CHEN 3/28'02
F	IC021132	YIHSIN CHEN 1/25'03
G	BC06742238	YuSan 7/25'06
H	BC097127845	Yihsin Chen

NOTES :

- HARMFUL MATERIAL CONTROL PLEASE FOLLOW FOXCONN'S DOC. "EPI12".
- PRODUCT NO. MATRIX:

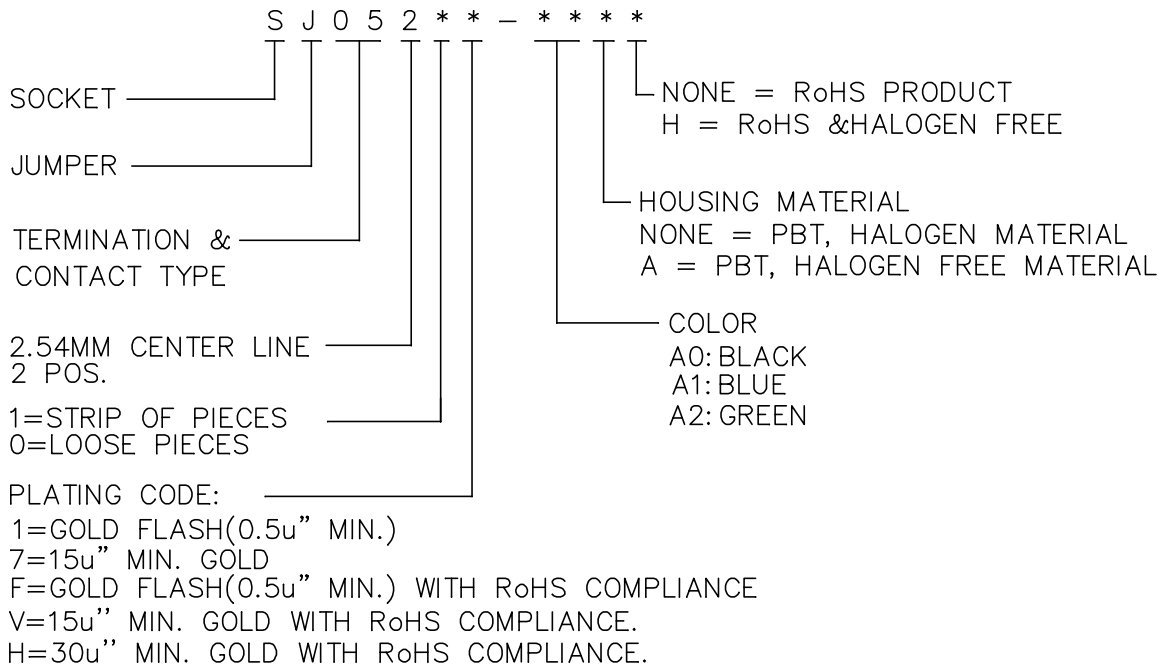

- THE CONCENTRATIONS OF Br&Cl CAN SATISFY THE REQUIREMENTS OF HALOGEN-FREE IN FOXCONN'S DOC "EPI12".
- PLEASE CONTACT FOXCONN SALES REPRESENTATIVE TO VARIETY PRODUCT DETAIL&AVAILABILITY.

2	CONTACT	10	COPPER ALLOY	PLATING CODE SEE ABOVE	
1	HOUSING	1	THERMOPLASTIC, UL 94V-0 RATING	SEE ABOVE FOR DETAIL	
ITEM	DESC.	Q'TY	MATERIAL	TREATMENT	REMARK
X. ±	X. * ±	UNITS mm	NAME(INTENDED USE)	<b>FOXCONN®</b> FOXCONN INTERCONNECT TECHNOLOGY LIMITED.	
.X ±	.X * ±	MAT'L	JUMPER CONNECTOR		
.XX ±	.XX * ±	FINISH	PART NO.(INTENDED USE)	CLASS: <input type="checkbox"/> CONFIDENTIAL <input type="checkbox"/> SECRET <input checked="" type="checkbox"/> GENERAL	
.XXX ±	.XXX * ±		SJ05 SERIES	TITLE: MATERIAL SHEET	
THESE DRAWINGS AND SPECIFICATIONS ARE THE PROPERTY OF FOXCONN INTERCONNECT TECHNOLOGY LIMITED. AND SHALL NOTBE REPRODUCED, COPIED OR USED IN ANY MANNER WITHOUT THE PRIOR WRITTEN CONSENT OF FOXCONN INTERCONNECT TECHNOLOGY LIMITED.			APPD: Shih-Wei Hsiao	DWG NO.: 307-0700-030	
			CHKD: Yen-Chih Chang		
			DRAW: Tao Shen 11/7'16		
				SCALE	SHEET
				N/A	1/1
					REV. HX3

# PRODUCT SPECIFICATIONS

1. PHYSICAL :

1-1. HOUSING :

THERMOPLASTIC, PBT,UL94 V-0 RATING.

1-2. CONTACT :

COPPER ALLOY, 50u" MIN. NICKEL PLATING OVER ALL,  
GOLD PLATING WITH LEAD FREE OVER NICKEL PATLING

2. ELECTRICAL :

2-1. CONTACT CURRENT RATING :3 AMPERES MAX.

2-2. INSULATION RESISTANCE:1000 MEGAOHMS MIN. INITIAL

2-3. DIELECTRIC WITHSTANDING VOLTAGE : 750 VAC RMS MIN. AT SEA LEVEL.

2. ELECTRICAL :

3-1. CONTACT RETENTION FORCE: 0.50KGf MIN.

3-2. INSERTION FORCE: 0.60 KGf MAX. PER CONTACT.

3-3. WITHDRAWAL FORCE: 0.028 KGf MIN. PER CONTACT.

4. ENVIRONMENTAL:

4-1. OPERATING TEMPERATURE : -55° C TO +105° C.

4-2. HARMFUL MATERIAL PLEASE FOLLOW FOXCONN'S DOC. "EPI12".

5. THE CONCENTRATIONS OF Br&Cl CAN SATISFY THE REQUIREMENTS OF HALOGEN-FREE IN FOXCONN'S DOC "EPI12".

6. PLEASE CONTACT FOXCONN SALES REPRESENTATIVE TO VERIFY PRODUCT DETAIL&AVAILABILITY.

C	BC-11-0139892	Yihsin Chen
B	BC06779394	Yusan
A	BC0355890	Ivan Laiw
REV.	ECN NO.	APPD.

<b>FOXCONN</b> HON HAI PRECISION IND. CO.,LTD. TAIPEI, TAIWAN, R.O.C.	
APPD. : Yihsin Chen	TITLE : SPECIFICATION, JUMPER CONN.
CHKD. : Wolfe Liu	PROD. SERIES : SJ05/06 SERIES
DR. : Yuke Chen	DWG. NO : 307-0100-432
12/21'11	REV. : C SHEET : 1/1

## X-ON Electronics

Largest Supplier of Electrical and Electronic Components

*Click to view similar products for [Headers & Wire Housings](#) category:*

*Click to view products by [Foxconn](#) manufacturer:*

Other Similar products are found below :

[0015917161](#) [0022155065](#) [57102-F02-18ULF](#) [58102-G61-06LF](#) [582553-1](#) [01.001.5753.1](#) [0050291907](#) [02.125.8002.8](#) [609-3404](#) [61062-3](#)  
[CSU011177004](#) [622-0430](#) [622-3653LF](#) [63453-116](#) [636-1030](#) [636-1427](#) [636-3427](#) [636-4007](#) [641938-9](#) [65495-038](#) [65692-001LF](#) [65781-018](#)  
[65781-047](#) [65817-010LF](#) [65817-015LF](#) [67095-007LF](#) [67601157](#) [68631-112](#) [68645-018](#) [699319-000](#) [70.362.1628.0](#) [70-4210](#) [70-4226B](#) [70-](#)  
[4853B](#) [71.350.2428.0](#) [733-134](#) [733-162](#) [MHR-64-VUAL](#) [80.063.4001.1](#) [800-90-001-10-001000](#) [801-43-002-10-013000](#) [801-43-006-10-](#)  
[002000](#) [803-43-024-10-001000](#) [803-93-012-10-001000](#) [8-1437020-4](#) [819-22-004-30-001101](#) [820-22-006-30-001101](#) [820-22-008-30-001101](#)  
[821-22-002-10-001101](#) [821-22-003-10-002101](#)