

OBSOLETE – PART DISCONTINUED

General Description

- DCX4710H is best suited for applications where the load needs to be turned on and off using micro-controllers, comparators or other control circuits, particularly at a point of load. It features a discrete pre-biased PNP transistor which can support continuous maximum current of 100 mA. It also contains a pre-biased NPN transistor which can be used as a control and can be biased using a higher supply. The component devices can be used as a part of circuit or as stand alone discrete devices.

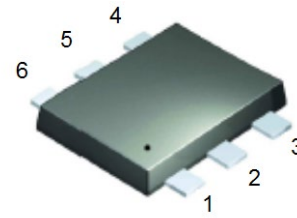

SOT-563

Features

- Built in Biasing Resistors
- Epitaxial Planar Die Construction
- Ideally Suited for Automated Assembly Processes
- Lead Free By Design/RoHS Compliant (Note 1)**
- "Green" Device (Note 2)**

Mechanical Data

- Case: SOT-563
- Case Material: Molded Plastic. "Green Molding" Compound. UL Flammability Classification Rating 94V-0
- Moisture Sensitivity: Level 1 per J-STD-020C
- Terminal Connections: See Fig. 2
- Terminals: Finish - Matte Tin annealed over Copper leadframe. Solderable per MIL-STD-202, Method 208
- Marking & Type Code Information: See Page 7
- Ordering Information: See Page 7
- Weight: 0.005 grams (approximate)

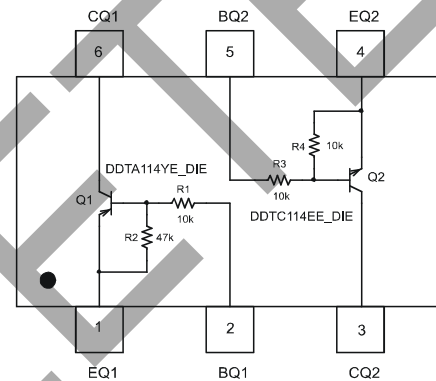

Schematic and Pin Configuration

Reference	Device Type	R1 (NOM)	R2 (NOM)	R3 (NOM)	R4 (NOM)
Q1	PNP	10KΩ	47KΩ	—	—
Q2	NPN	—	—	10KΩ	10KΩ

Maximum Ratings: Total Device @_{T_A} = 25°C unless otherwise specified

Characteristic	Symbol	Value	Unit
Output Current	I_{out}	100	mA
Power Dissipation (Note 3)	P_d	150	mW
Power Derating Factor above 45°C	P_{der}	1.43	mW/°C
Junction Operation and Storage Temperature Range	P_d	-55 to +150	°C
Thermal Resistance, Junction to Ambient Air (Note 3) (Equivalent to one heated junction of PNP transistor) @ $T_A = 25^\circ\text{C}$	$R_{\theta JA}$	833	°C/W

- Notes:
- No purposefully added lead.
 - Diodes Inc.'s "Green" policy can be found on our website at http://www.diodes.com/products/lead_free/index.php.
 - Device mounted on FR-4 PCB, 1 inch x 0.85 inch x 0.062 inch; as per Diodes Inc. suggested pad layout document AP02001 on our website at <http://www.diodes.com/datasheets/ap02001.pdf>.

Sub-Component Device – Pre-Biased PNP Transistor (Q1) @ $T_A = 25^\circ\text{C}$ unless otherwise specified

Characteristic	Symbol	Value	Unit
Collector-Base Voltage	V_{CBO}	-50	V
Collector-Emitter Voltage	V_{CEO}	-50	V
Supply Voltage	V_{CC}	-50	V
Input Voltage	V_{IN}	+6 to -40	V
Output Current (dc)	$I_{C(max)}$	-100	mA

Sub-Component Device – Pre-Biased NPN Transistor (Q2) @ $T_A = 25^\circ\text{C}$ unless otherwise specified

Characteristic	Symbol	Value	Unit
Collector-Base Voltage	V_{CBO}	50	V
Collector-Emitter Voltage	V_{CEO}	50	V
Supply Voltage	V_{CC}	50	V
Input Voltage	V_{IN}	-10 to +40	V
Output Current (dc)	$I_{C(max)}$	100	mA

Electrical Characteristics: Pre-Biased PNP Transistor (Q1) @ $T_A = 25^\circ\text{C}$ unless otherwise specified

Characteristic	Symbol	Min	Typ	Max	Unit	Test Condition
OFF CHARACTERISTICS						
Collector-Base Cut Off Current	I_{CBO}	—	—	-100	nA	$V_{CB} = -50\text{V}, I_E = 0$
Collector-Base Breakdown Voltage	$V_{(BR)CBO}$	-50	—	—	V	$I_C = -10\mu\text{A}, I_E = 0$
Collector-Emitter Breakdown Voltage	$V_{(BR)CEO}$	-50	—	—	V	$I_C = -4\text{mA}, I_B = 0$
Input Off Voltage	$V_{I(OFF)}$	—	—	-0.3	V	$V_{CE} = -5\text{V}, I_C = -100\mu\text{A}$
Output Off Current	$I_{O(OFF)}$	—	—	-0.5	μA	$V_{CC} = -50\text{V}, V_I = 0\text{V}$
ON CHARACTERISTICS						
DC Current Gain	h_{FE}	80	—	—	—	$V_{CE} = -5\text{V}, I_C = -5\text{mA}$
Collector-Emitter Saturation Voltage	$V_{CE(sat)}$	—	—	-0.25	V	$I_C = -10\text{mA}, I_B = -0.3\text{mA}$
Output On Voltage	$V_{O(ON)}$	—	-0.1	-0.3	V	$I_O/I_I = -10\text{mA}/-0.5\text{mA}$
Input On Voltage (Load is present)	$V_{I(ON)}$	-1.4	-0.9	—	V	$V_O = -0.3\text{V}, I_C = -2\text{mA}$
Input Current	I_I	—	—	-0.88	mA	$V_I = -5\text{V}$
Input Resistor +/- 30% (Base)	$\Delta R1$	7	10	13	$\text{K}\Omega$	—
Pull-up Resistor (Base to Vcc supply)	R2	32	47	62	$\text{K}\Omega$	—
Resistor Ratio	$\Delta(R2/R1)$	20	—	20	%	—
SMALL SIGNAL CHARACTERISTICS						
Transition Frequency (gain bandwidth product)	f_T	—	250	—	MHz	$V_{CE} = -10\text{V}, I_E = -5\text{mA}, f = 100\text{MHz}$

*Pulse Test: Pulse width, $t_p < 300 \mu\text{s}$, Duty Cycle, $d \leq 0.02$

Pre-Biased NPN Transistor (Q2) @ $T_A = 25^\circ\text{C}$ unless otherwise specified

Characteristic	Symbol	Min	Typ	Max	Unit	Test Condition
OFF CHARACTERISTICS						
Collector-Base Cut Off Current	I_{CBO}	—	—	100	nA	$V_{CB} = 50\text{V}, I_E = 0$
Collector-Base Breakdown Voltage	$V_{(BR)CBO}$	50	—	—	V	$I_C = 10\mu\text{A}, I_E = 0$
Collector-Emitter Breakdown Voltage	$V_{(BR)CEO}$	50	—	—	V	$I_C = 2\text{mA}, I_B = 0$
Input Off Voltage	$V_{I(OFF)}$	—	1.2	0.5	V	$V_{CE} = 5\text{V}, I_C = 100\mu\text{A}$
Output Current	$I_{O(OFF)}$	—	—	0.5	μA	$V_{CC} = 50\text{V}, V_I = 0\text{V}$
ON CHARACTERISTICS						
DC Current Gain	h_{FE}	35	—	—	—	$V_{CE} = 5\text{V}, I_C = 5\text{mA}$
Collector-Emitter Saturation Voltage	$V_{CE(sat)}$	—	—	0.25	V	$I_C = -10\text{mA}, I_B = -0.3\text{mA}$
Output On Voltage	$V_{O(ON)}$	—	0.1	0.3	V	$I_O/I_I = 10\text{mA}/0.5\text{mA}$
Input On Voltage	$V_{I(ON)}$	3	1.6	—	V	$V_O = 0.3\text{V}, I_C = 2\text{mA}$
Input Current	I_I	—	—	0.88	mA	$V_I = 5\text{V}$
Input Resistor +/- 30% (Base)	R1	7	10	13	$\text{K}\Omega$	—
Resistor Ratio	(R2/R1)	0.8	1	1.2	—	—
SMALL SIGNAL CHARACTERISTICS						
Transition Frequency (Gain bandwidth product)	f_T	—	250	—	MHz	$V_{CE} = 10\text{V}, I_E = 5\text{mA}, f = 100\text{MHz}$

*Pulse Test: Pulse width, $t_p < 300 \mu\text{s}$, Duty Cycle, $d < 0.02$

Typical Characteristics @ $T_{amb} = 25^\circ\text{C}$ unless otherwise specified

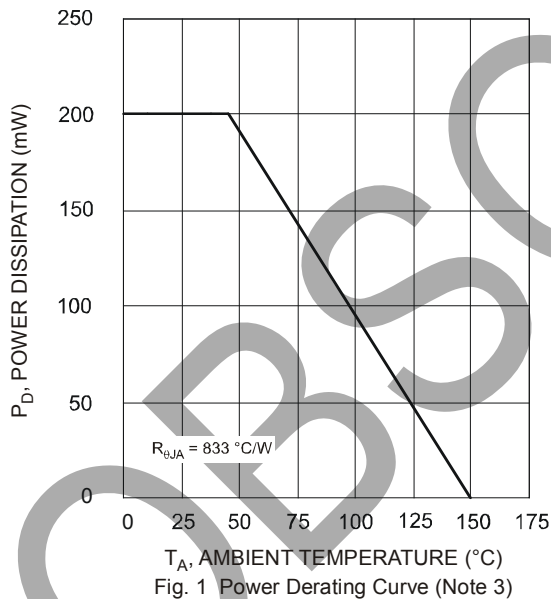

Fig. 1 Power Derating Curve (Note 3)

Notes: 3. Device mounted on FR-4 PCB, 1 inch x 0.85 inch x 0.062 inch; as per Diodes Inc. suggested pad layout document AP02001 on our website at <http://www.diodes.com/datasheets/ap02001.pdf>.

Characteristics Curves of PNP Transistor (Q1) @ $T_{amb} = 25^{\circ}C$ unless otherwise specified

OBSOLETE - PART DISCONTINUED

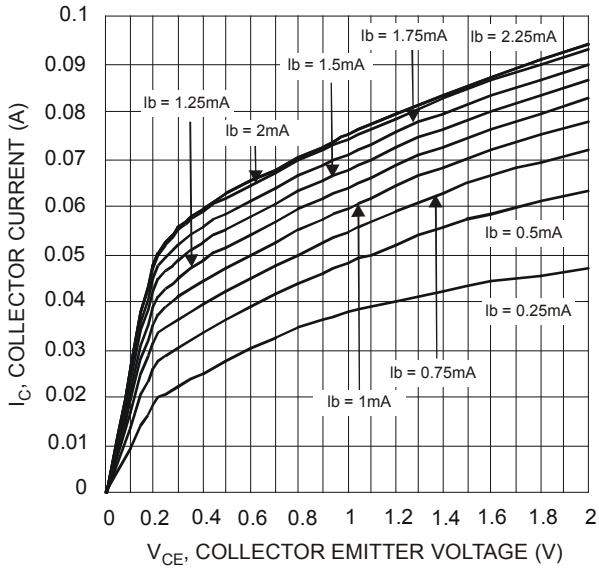

Fig. 2 V_{CE} vs. I_C

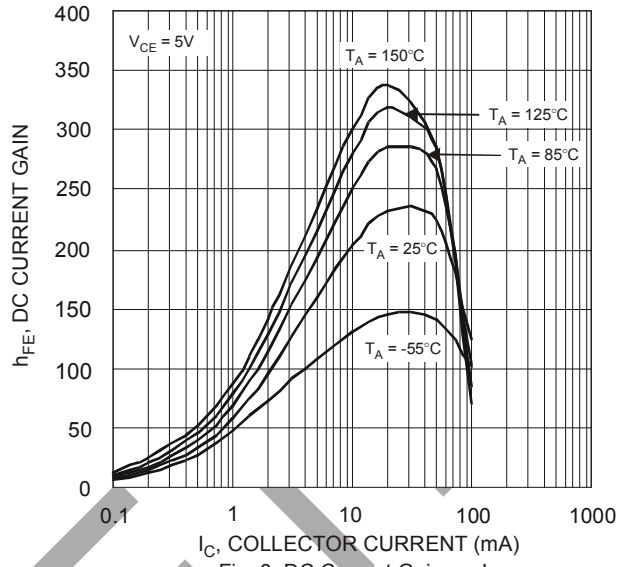

Fig. 3 DC Current Gain vs. I_C

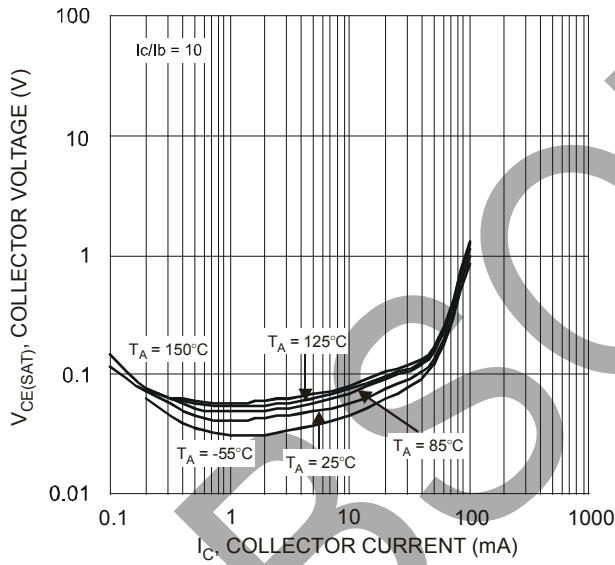

Fig. 4 I_C vs. $V_{CE(SAT)}$

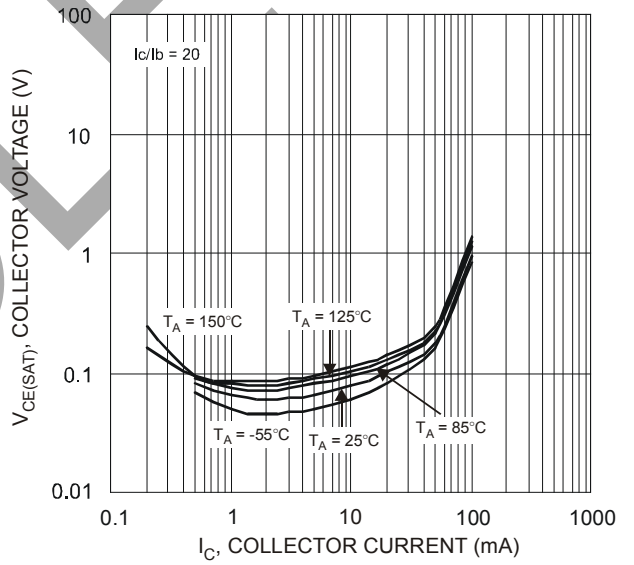

Fig. 5 I_C vs. $V_{CE(SAT)}$

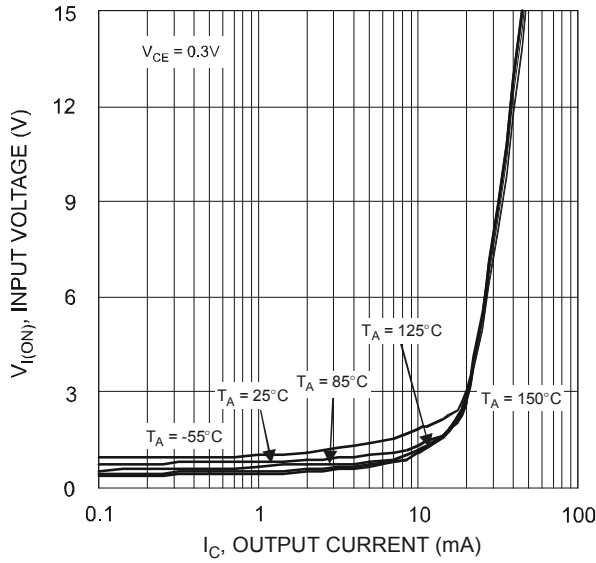

Fig. 6 Input Voltage vs. Collector Current

Characteristics Curves of NPN Transistor (Q2) @ $T_{amb} = 25^\circ\text{C}$ unless otherwise specified

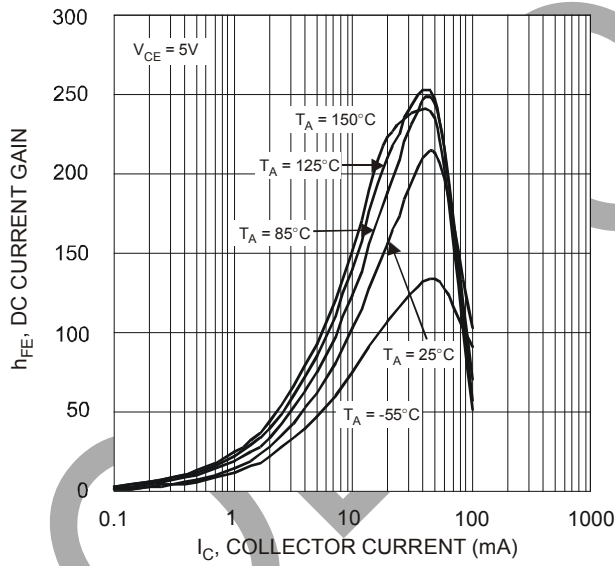

Fig. 7 DC Current Gain vs. I_C

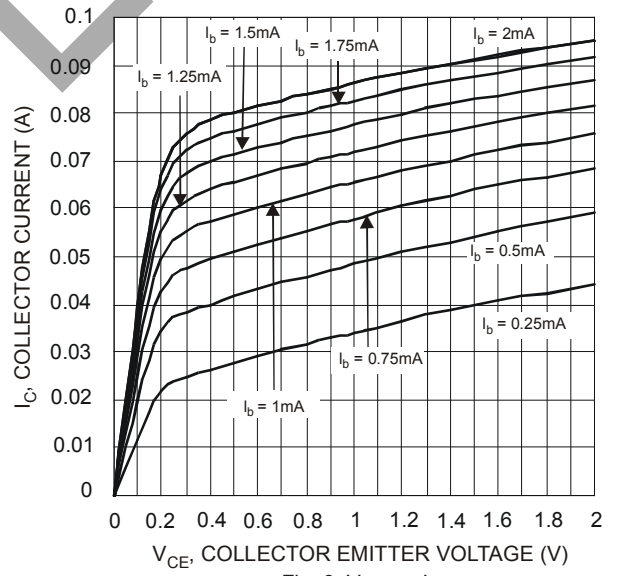

Fig. 8 V_{CE} vs. I_C

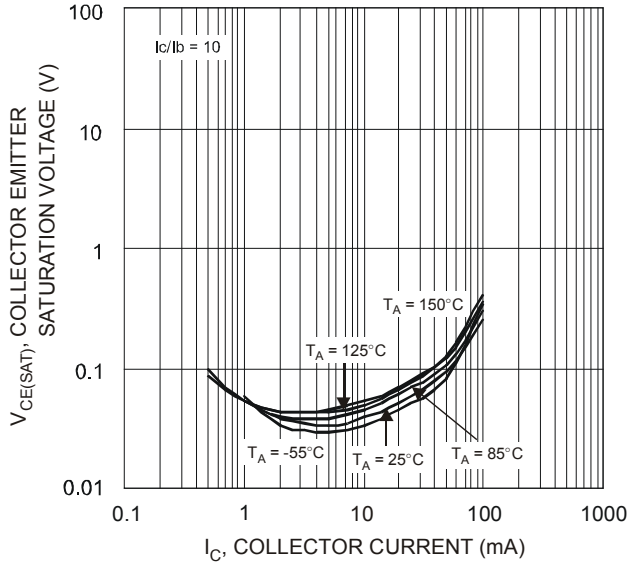

Fig. 9 I_C vs. $V_{CE(SAT)}$

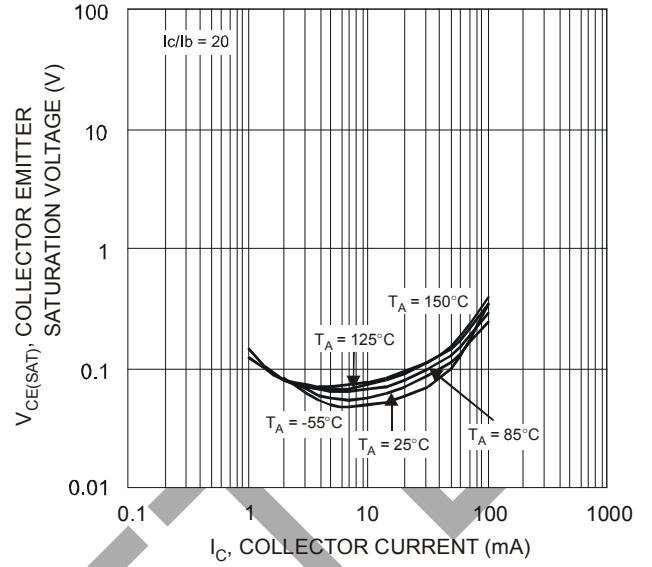

Fig. 10 I_C vs. $V_{CE(SAT)}$

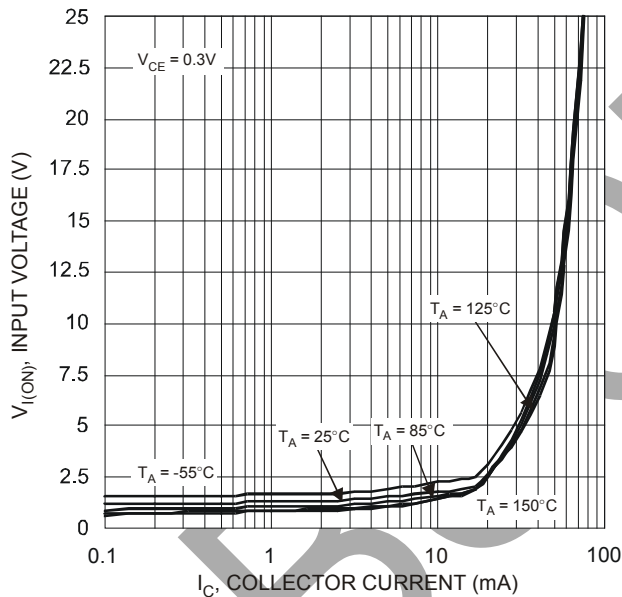

Fig. 11 Input Voltage vs. Output Current

Ordering Information (Note 5)

Device	Marking Code	Packaging	Shipping
DCX4710H-7	C02	SOT-563	3000/Tape & Reel

Notes: 5. For Packaging Details, go to our website at <http://www.diodes.com/datasheets/ap02007.pdf>.

Marking Information

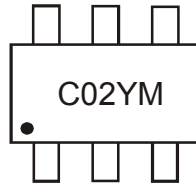

Fig. 12

C02 = Product Type Marking Code
 YM = Date Code Marking
 Y = Year e.g., T = 2006
 M = Month e.g., 9 = September

Date Code Key

Year	2006	2007	2008	2009	2010	2011	2012
Code	T	U	V	W	X	Y	Z

Month	Jan	Feb	Mar	Apr	May	Jun	Jul	Aug	Sep	Oct	Nov	Dec
Code	1	2	3	4	5	6	7	8	9	O	N	D

OBSOLETE - PART DISCONTINUED

OBSOLETE

IMPORTANT NOTICE

1. DIODES INCORPORATED AND ITS SUBSIDIARIES ("DIODES") MAKE NO WARRANTY OF ANY KIND, EXPRESS OR IMPLIED, WITH REGARDS TO ANY INFORMATION CONTAINED IN THIS DOCUMENT, INCLUDING, BUT NOT LIMITED TO, THE IMPLIED WARRANTIES OF MERCHANTABILITY, FITNESS FOR A PARTICULAR PURPOSE OR NON-INFRINGEMENT OF THIRD PARTY INTELLECTUAL PROPERTY RIGHTS (AND THEIR EQUIVALENTS UNDER THE LAWS OF ANY JURISDICTION).
2. The Information contained herein is for informational purpose only and is provided only to illustrate the operation of Diodes products described herein and application examples. Diodes does not assume any liability arising out of the application or use of this document or any product described herein. This document is intended for skilled and technically trained engineering customers and users who design with Diodes products. Diodes products may be used to facilitate safety-related applications; however, in all instances customers and users are responsible for (a) selecting the appropriate Diodes products for their applications, (b) evaluating the suitability of the Diodes products for their intended applications, (c) ensuring their applications, which incorporate Diodes products, comply the applicable legal and regulatory requirements as well as safety and functional-safety related standards, and (d) ensuring they design with appropriate safeguards (including testing, validation, quality control techniques, redundancy, malfunction prevention, and appropriate treatment for aging degradation) to minimize the risks associated with their applications.
3. Diodes assumes no liability for any application-related information, support, assistance or feedback that may be provided by Diodes from time to time. Any customer or user of this document or products described herein will assume all risks and liabilities associated with such use, and will hold Diodes and all companies whose products are represented herein or on Diodes' websites, harmless against all damages and liabilities.
4. Products described herein may be covered by one or more United States, international or foreign patents and pending patent applications. Product names and markings noted herein may also be covered by one or more United States, international or foreign trademarks and trademark applications. Diodes does not convey any license under any of its intellectual property rights or the rights of any third parties (including third parties whose products and services may be described in this document or on Diodes' website) under this document.
5. Diodes products are provided subject to Diodes' Standard Terms and Conditions of Sale (<https://www.diodes.com/about/company/terms-and-conditions/terms-and-conditions-of-sales/>) or other applicable terms. This document does not alter or expand the applicable warranties provided by Diodes. Diodes does not warrant or accept any liability whatsoever in respect of any products purchased through unauthorized sales channel.
6. Diodes products and technology may not be used for or incorporated into any products or systems whose manufacture, use or sale is prohibited under any applicable laws and regulations. Should customers or users use Diodes products in contravention of any applicable laws or regulations, or for any unintended or unauthorized application, customers and users will (a) be solely responsible for any damages, losses or penalties arising in connection therewith or as a result thereof, and (b) indemnify and hold Diodes and its representatives and agents harmless against any and all claims, damages, expenses, and attorney fees arising out of, directly or indirectly, any claim relating to any noncompliance with the applicable laws and regulations, as well as any unintended or unauthorized application.
7. While efforts have been made to ensure the information contained in this document is accurate, complete and current, it may contain technical inaccuracies, omissions and typographical errors. Diodes does not warrant that information contained in this document is error-free and Diodes is under no obligation to update or otherwise correct this information. Notwithstanding the foregoing, Diodes reserves the right to make modifications, enhancements, improvements, corrections or other changes without further notice to this document and any product described herein. This document is written in English but may be translated into multiple languages for reference. Only the English version of this document is the final and determinative format released by Diodes.
8. Any unauthorized copying, modification, distribution, transmission, display or other use of this document (or any portion hereof) is prohibited. Diodes assumes no responsibility for any losses incurred by the customers or users or any third parties arising from any such unauthorized use.

Copyright © 2021 Diodes Incorporated

www.diodes.com

X-ON Electronics

Largest Supplier of Electrical and Electronic Components

Click to view similar products for [Bipolar Transistors - Pre-Biased](#) category:

Click to view products by [Diodes Incorporated](#) manufacturer:

Other Similar products are found below :

[RN1607\(TE85L,F\)](#) [DTA124GKAT146](#) [DTA144WETL](#) [DTA144WKAT146](#) [DTC113EET1G](#) [DTC115TETL](#) [DTC115TKAT146](#)
[DTC124TETL](#) [DTC144ECA-TP](#) [DTC144VUAT106](#) [MUN5241T1G](#) [NSBA114TDP6T5G](#) [NSBA143ZF3T5G](#) [NSBC114YF3T5G](#)
[NSBC123TF3T5G](#) [SMUN5330DW1T1G](#) [SSVMUN5312DW1T2G](#) [RN1303\(TE85L,F\)](#) [RN4605\(TE85L,F\)](#) [TTEPROTOTYPE79](#)
[DDTC114EUAQ-7-F](#) [EMH15T2R](#) [SMUN2214T3G](#) [NSBC114TF3T5G](#) [NSBC143ZPDP6T5G](#) [NSVMUN5113DW1T3G](#)
[SMUN5230DW1T1G](#) [SMUN5133T1G](#) [SMUN2214T1G](#) [DTC114EUA-TP](#) [NSBA144EF3T5G](#) [NSVDTA114EET1G](#) [2SC2223-T1B-A](#)
[2SC3912-TB-E](#) [SMUN5237DW1T1G](#) [SMUN5213DW1T1G](#) [SMUN5114DW1T1G](#) [SMUN2111T1G](#) [NSVDTC144EM3T5G](#) [DTC124ECA-](#)
[TP](#) [DTC123TM3T5G](#) [DTA114ECA-TP](#) [DTA113EM3T5G](#) [DCX115EK-7-F](#) [DTC113EM3T5G](#) [NSVMUN5135DW1T1G](#)
[NSVDTC143ZM3T5G](#) [SMUN5216DW1T1G](#) [NSVMUN5312DW1T2G](#) [NSVMUN5215DW1T1G](#)