

# MINIATURE MICROSWITCHES - POSITIVE BREAK

## 831607

- › Coil spring snap-action mechanism with wiping contacts
- › Positive opening action according to IEC 60947-5-1 Annex K
- › Ratings from 10 mA 4 V<sub>DC</sub> to 6 A 250 V<sub>AC</sub>
- › Very long life
- › Extended range of terminals
- › cURus approved
- › Choice of actuators: stainless steel or plastic

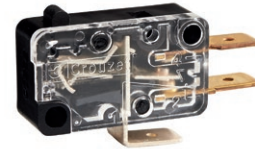

### Main specifications

		Positive break 831607	
		Standard	Dual-current (DORE)
<b>Function</b>	<b>Connections</b>		
I (changeover)	W2 (solder)	83160702	83160796
I (changeover)	W3 (QC 6.3x0.8)	83160704	83160786
I (changeover)	W6 (QC 4.8x0.5)	83160706	●
I (changeover)	X1 (PCB, straight)	●	●
I (changeover)	X2 (PCB, rear)	●	●
I (changeover)	X3 (PCB, front)	83160708	●
R (normally closed)	W2 (solder)	83160701	83160794
R (normally closed)	W3 (QC 6.3x0.8)	83160703	83160797
R (normally closed)	W6 (QC 4.8x0.5)	83160705	●
R (normally closed)	X2 (PCB, rear)	83160732	●
R (normally closed)	X3 (PCB, front)	83160707	●
<b>Electrical characteristics</b>			
Positive opening action		⊞	⊞
Rating nominal / 250 V <sub>AC</sub> (A)		6	6*
Thermal current (I <sub>th</sub> ) (A)		10	10
<b>Mechanical characteristics</b>			
Maximum operating force (N)		4	4
Min. Release force (N)		1.5	1.5
Minimum positive opening force (N)		18	18
Max. Allowable overtravel force (N)		200	200
Rest position max. (mm)		15.7	15.7
Operating position (mm)		14.8±0.3	14.8±0.3
Positive opening position (mm)		13.5	13.5
Maximum differential travel (mm)		0.3	0.3
Min. overtravel (mm)		1.3	1.3
Ambient operating temperature (°C)		-40 → +85	-40 → +85
Mechanical life (operations)		10 <sup>7</sup>	10 <sup>7</sup>
Contact gap (mm)		1.2	1.2
Weight (g)		7	7

### Additional specifications

- Case, Button: PBT GF (UL 94-V0 / GWFI 960 °C)
- Cover: PC (UL 94-V0 / GWFI 850 °C), transparent
- Contacts: silver alloy, gold-plated silver alloy (dual-current)
- Terminals: brass (except W2/X: copper nickel), silver plated common
- Levers: stainless steel or polyamide, polyamide roller
- Degree of protection: IP40 (mechanism)
- Recommended actuating speed: 0.1 mm/s to 0.5 m/s
- Rated insulation voltage U<sub>i</sub>: 250 V
- Impulse withstand voltage U<sub>imp</sub>: 4 kV
- Certification marks:

### Product adaptations



- › **Special levers : special shapes and lengths**
- › **Special connections : angled, screw with clamp (W5), full wiring with custom connector....**
- › **Adjustable fixing by metal threaded barrel (SP9627)**
- › **Variant for irradiated environment**

Standard product

Product made to order

Contact us

## Principles

Single break snap-action switch with positive opening action on NC contacts (1-2) according to IEC 60947-5-1 Annex K

Changeover - SPDT (form C)

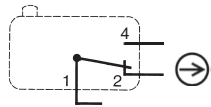

Normally closed - SPST-NC (form B)

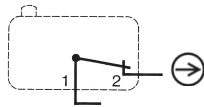

## Curves

### Electrical life

- Resistive load: 250 V $\sim$  6 A: 10<sup>5</sup> cycles
- Inductive load (IEC 60947-5-1) : AC15: 250 V $\sim$  6 A: 0.3 x 10<sup>5</sup> cycles  
 DC13: 24 V $\text{---}$  20 W L/R = 40 ms: 3 x 10<sup>5</sup> cycles  
 120 V $\text{---}$  20 W L/R = 40 ms: 5 x 10<sup>5</sup> cycles

\* Dual-current models are designed to operate equally well on low current (10 mA 4 V minimum recommended) or medium-current (6 A maximum) circuits. However, a given product should only be used to switch one type of circuit during its working life

## Dimensions

### Product

831607

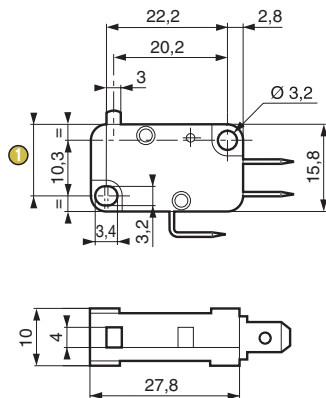

① Total travel position = 13.2 max.

## Connections

### W2 solder

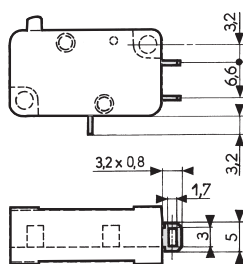

### W3 quick-connect 6.3 x 0.8

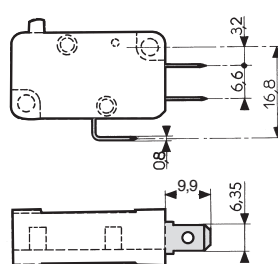

### W6 quick-connect 4.8x0.5

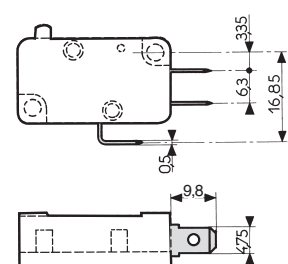

### X1 for PCB, straight output

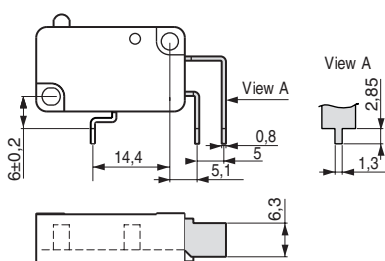

### X2 for PCB, rear output

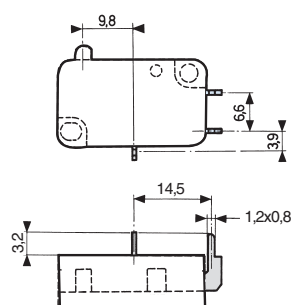

### X3 for PCB, front output

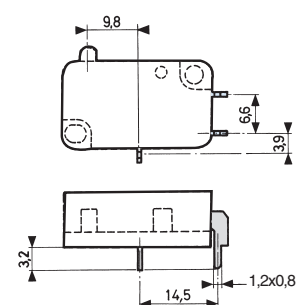

## Actuator mounting position

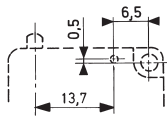

## Actuators

153AX flat

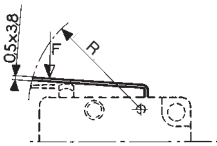

153EX roller

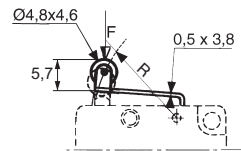

153FX dummy roller

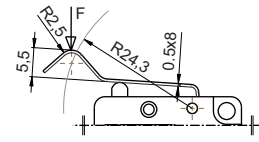

## Actuators and mounting accessories

### Part numbers for standard actuators

**79211670\***

**79211672\***

**79211668\***

Actuators

Flat **153AX** R16.2

Roller **153EX** R15.8

Dummy roller **153FX** R24.3



Operating force - max.	N	4	4	2.4
Release force - min.	N	1	1	0.9
Min. positive opening force	N	18	18	11
Maximum rest position	mm	16.2	21.3	21.8
Operating position	mm	15.3 ±0.3	20.5 ±0.45	20.3 ±0.6
Positive opening position	mm	14	19.2	18
Maximum total travel position	mm	13.9	19.1	17.6

\* We recommend that levers are mounted in our factories. See preferred part numbers in table below.  
For unmounted supply, please also order associated pin **79210424**.

### Part numbers for standard actuators

**79211694\***

Actuators

Two-pole **153A2XB** R 24\*\*

Flexible with roller **153B\*\***

Plastic **153V\*\***

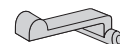
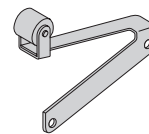
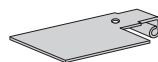

\*\* Consult us

## 831607 microswitches with referenced actuators

Actuators	153AX R16.2	153EX R15.8	153FX R24.3
	79211670	79211672	79211668
<b>831607 Standard</b>	I W2	●	●
	I W3	●	●
	I X3	●	●
	R W2	●	●
	R W3	●	●
	R X3	●	●

Standard product

Product made to order

● Contact us

## Installation recommendations

See “Basic technical concepts”

## How to order

Use the 8 digit part numbers when they are defined

Other cases, precise: Type of microswitch - Function - Connection - Contact\* - Actuator\* - Adaptation\*  
\* if needed

Example: 831607 R W3 DORE 153AX R16.2

## Examples of special adaptations



Metal plunger and threaded barrel for heavy duty and precise setting (SP9627)

### Warning:

The product information contained in this catalogue is given purely as information and does not constitute a representation, warranty or any form of contractual commitment. Crouzet Automatismes SAS and its subsidiaries reserve the right to modify their products without notice. It is imperative that we should be consulted over any particular use or application of our products and it is the responsibility of the buyer to establish, particularly through all the appropriate tests, that the product is suitable for the use or application. Under no circumstances will our warranty apply, nor shall we be held responsible for any application (such as any modification, addition, deletion, use in conjunction with other electrical or electronic components, circuits or assemblies, or any other unsuitable material or substance) which has not been expressly agreed by us prior to the sale of our products.

## X-ON Electronics

Largest Supplier of Electrical and Electronic Components

*Click to view similar products for [Basic / Snap Action Switches](#) category:*

*Click to view products by [Crouzet](#) manufacturer:*

Other Similar products are found below :

[5SM901-S12](#) [5SM9-S12N195](#) [602EN532](#) [602EN535-RB](#) [602HE5-RB1](#) [604HE162](#) [604HE223-6B](#) [624HE17-RB](#) [6HM82](#) [6HM89](#) [6SE1](#)  
[6SX1-H58](#) [70500216](#) [70599106](#) [MBD5B1](#) [MBH2731](#) [73-316-0012](#) [EXD-AR20](#) [79211923](#) [79218589](#) [7AS12](#)  
[MIL30126AB6BBMD4A12XAU](#) [ML-1155](#) [ML-1376](#) [831010C3.0](#) [831090C2.EL](#) [83131904](#) [84212012](#) [8AS239](#) [8HM73-3](#) [8SX26-H33](#)  
[914CE1-6G](#) [PL-100](#) [11SM1077-H4](#) [11SM1077-H58](#) [11SM1-TN107](#) [11SM405](#) [11SM8423-H2](#) [11SX37-T](#) [11SX48-H58](#) [11SM2442-T](#)  
[11SM76-T](#) [11SM77-H58](#) [11SM77-T](#) [11SM863-T](#) [11SM866](#) [A7CN-1M-1-LEFT](#) [A831700C7.0](#) [121EN188-R](#) [1245.0120](#)