

# XLamp® XHP35.2 Pro9™ LEDs

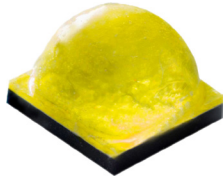

XHP35.2 High-Density Pro9 LED

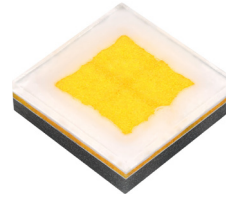

XHP35.2 High-Intensity Pro9 LED

## PRODUCT DESCRIPTION

The XLamp® XHP35.2 Pro9™ LED is the next generation of Extreme High Power LEDs available in the XP footprint. Built on Cree LED's latest high-power LED array technology, the XHP35.2 Pro9 LED improves the voltage characteristics, efficacy and reliability of the XHP35 LED in the same 3.45 mm x 3.45 mm footprint. The new XHP35.2 Pro9 LED provides an easy drop-in upgrade so that lighting manufacturers can achieve higher system LPW on existing XHP35 designs with minimal system redesign cost.

The XHP35.2 Pro9 LED offers a high-intensity option. In this document, the term XHP35.2 Pro9 denotes the XHP35.2 Pro9 LED without regard to high density or high intensity. The terms High Density and High Intensity are used when necessary to differentiate the performance of the two options.

## FEATURES

- Available in 3-step & 2-step EasyWhite® bins at 2700 K–4000 K CCT
- Available in 90- & 95-CRI minimum
- Binned at 85 °C
- Maximum drive current: 700 mA
- Low thermal resistance: 0.7 °C/W
- Wide viewing angle - High Density: 130°, High Intensity: 120°
- Unlimited floor life at ≤ 30 °C/85% RH
- Reflow solderable - JEDEC J-STD-020C
- RoHS and REACH compliant

## TABLE OF CONTENTS

Characteristics .....	2
Flux Characteristics, Order Codes & Bins - High-Density Pro9™ .....	3
Flux Characteristics, Order Codes & Bins - High-Intensity Pro9™ .....	4
Relative Spectral Power Distribution .....	5
Relative Flux vs. Junction Temperature.....	6
Electrical Characteristics.....	6
Relative Flux vs. Current.....	7
Relative Chromaticity vs. Current.....	8
Relative Chromaticity vs. Temperature.....	8
Typical Spatial Distribution.....	9
Thermal Design.....	9
Performance Groups - Luminous Flux.....	10
Performance Groups - Chromaticity .....	11
Bin and Order Code Formats.....	13
Reflow Soldering Characteristics.....	14
Notes .....	15
Mechanical Dimensions .....	17
Tape and Reel.....	19
Packaging.....	22



## CHARACTERISTICS

Characteristics	Unit	Minimum	Typical	Maximum
Thermal resistance, junction to solder point	°C/W		0.7	
Viewing angle (FWHM) - High Density	degrees		130	
Viewing angle (FWHM) - High Intensity	degrees		120	
Temperature coefficient of voltage	mV/°C		-5	
ESD withstand voltage (HBM per Mil-Std-883D)			Class 3B	
DC forward current	mA			700
Reverse voltage	V			1
Forward voltage (@ 350 mA, 85 °C)	V		11.2	12.2
LED junction temperature	°C			150

### Note

- Thermal resistance measurement was performed per the JEDEC JESD51-14 standard. See the [Thermal Resistance Measurement application note](#) for more details.

**FLUX CHARACTERISTICS, ORDER CODES & BINS - HIGH-DENSITY PRO9™ (I<sub>F</sub> = 350 mA, T<sub>J</sub> = 85 °C)**

The following table provides order codes for XLamp XHP35.2 High-Density Pro9 LEDs. For a complete description of how the flux and chromaticity groups are reflected in the bin code and order code nomenclature, please see the Bin and Order Code Formats section (page 13).

Nominal CCT	CRI		Minimum Luminous Flux (lm)	2-Step		3-Step	
	Min.	Typ		Group	Order Code	Group	Order Code
4000 K	90	92	510	40H	XHP35B-00-0000-ODPUD240H	40G	XHP35B-00-0000-ODPUD240G
			475	40H	XHP35B-00-0000-ODPUC440H	40G	XHP35B-00-0000-ODPUC440G
	95	98	475	40H	XHP35B-00-0000-ODPZC440H	40G	XHP35B-00-0000-ODPZC440G
			440	40H	XHP35B-00-0000-ODPZC240H	40G	XHP35B-00-0000-ODPZC240G
			410	40H	XHP35B-00-0000-ODPZB440H	40G	XHP35B-00-0000-ODPZB440G
3500 K	90	92	510	35H	XHP35B-00-0000-ODPUD235H	35G	XHP35B-00-0000-ODPUD235G
			475	35H	XHP35B-00-0000-ODPUC435H	35G	XHP35B-00-0000-ODPUC435G
	95	98	475	35H	XHP35B-00-0000-ODPZC435H	35G	XHP35B-00-0000-ODPZC435G
			440	35H	XHP35B-00-0000-ODPZC235H	35G	XHP35B-00-0000-ODPZC235G
			410	35H	XHP35B-00-0000-ODPZB435H	35G	XHP35B-00-0000-ODPZB435G
3000 K	90	92	475	30H	XHP35B-00-0000-ODPUC430H	30G	XHP35B-00-0000-ODPUC430G
			440	30H	XHP35B-00-0000-ODPUC230H	30G	XHP35B-00-0000-ODPUC230G
	95	98	440	30H	XHP35B-00-0000-ODPZC230H	30G	XHP35B-00-0000-ODPZC230G
			410	30H	XHP35B-00-0000-ODPZB430H	30G	XHP35B-00-0000-ODPZB430G
2700 K	90	92	440	27H	XHP35B-00-0000-ODPUC227H	27G	XHP35B-00-0000-ODPUC227G
			410	27H	XHP35B-00-0000-ODPUB427H	27G	XHP35B-00-0000-ODPUB427G
	95	98	410	27H	XHP35B-00-0000-ODPZB427H	27G	XHP35B-00-0000-ODPZB427G
			380	27H	XHP35B-00-0000-ODPZB227H	27G	XHP35B-00-0000-ODPZB227G

**Notes:**

- Cree LED maintains a tolerance of ±7% on flux and power measurements, ±0.005 on chromaticity (CC<sub>x</sub>, CC<sub>y</sub>) measurements and ±2 on CRI measurements. See the Measurements section (page 15).
- XLamp XHP35.2 Pro9 LED order codes specify only a minimum flux bin and not a maximum. Cree LED may ship reels in flux bins higher than the minimum specified by the order code without advance notice. Shipments will always adhere to the chromaticity bin restrictions specified by the order code.

**FLUX CHARACTERISTICS, ORDER CODES & BINS - HIGH-INTENSITY PRO9™ (I<sub>F</sub> = 350 mA, T<sub>J</sub> = 85 °C)**

The following table provides order codes for XLamp XHP35.2 High-Intensity Pro9 LEDs. For a complete description of how the flux and chromaticity groups are reflected in the bin code and order code nomenclature, please see the Bin and Order Code Formats section (page 13).

Nominal CCT	CRI		Minimum Luminous Flux (lm)	2-Step		3-Step	
	Min.	Typ		Group	Order Code	Group	Order Code
4000 K	90	92	440	40H	XHP35B-H0-0000-0DPUC240H	40G	XHP35B-H0-0000-0DPUC240G
			410	40H	XHP35B-H0-0000-0DPUB440H	40G	XHP35B-H0-0000-0DPUB440G
	95	98	380	40H	XHP35B-H0-0000-0DPZB240H	40G	XHP35B-H0-0000-0DPZB240G
			355	40H	XHP35B-H0-0000-0DPZA440H	40G	XHP35B-H0-0000-0DPZA440G
3500 K	90	92	440	35H	XHP35B-H0-0000-0DPUC235H	35G	XHP35B-H0-0000-0DPUC235G
			410	35H	XHP35B-H0-0000-0DPUB435H	35G	XHP35B-H0-0000-0DPUB435G
	95	98	380	35H	XHP35B-H0-0000-0DPZB235H	35G	XHP35B-H0-0000-0DPZB235G
			355	35H	XHP35B-H0-0000-0DPZA435H	35G	XHP35B-H0-0000-0DPZA435G
3000 K	90	92	440	30H	XHP35B-H0-0000-0DPUC230H	30G	XHP35B-H0-0000-0DPUC230G
			410	30H	XHP35B-H0-0000-0DPUB430H	30G	XHP35B-H0-0000-0DPUB430G
	95	98	380	30H	XHP35B-H0-0000-0DPZB230H	30G	XHP35B-H0-0000-0DPZB230G
			355	30H	XHP35B-H0-0000-0DPZA430H	30G	XHP35B-H0-0000-0DPZA430G
2700 K	90	92	410	27H	XHP35B-H0-0000-0DPUB427H	27G	XHP35B-H0-0000-0DPUB427G
			380	27H	XHP35B-H0-0000-0DPUB227H	27G	XHP35B-H0-0000-0DPUB227G
	95	98	380	27H	XHP35B-H0-0000-0DPZB227H	27G	XHP35B-H0-0000-0DPZB227G
			355	27H	XHP35B-H0-0000-0DPZA427H	27G	XHP35B-H0-0000-0DPZA427G

**Notes:**

- Cree LED maintains a tolerance of ±7% on flux and power measurements, ±0.005 on chromaticity (CCx, CCy) measurements and ±2 on CRI measurements. See the Measurements section (page 15).
- XLamp XHP35.2 Pro9 LED order codes specify only a minimum flux bin and not a maximum. Cree LED may ship reels in flux bins higher than the minimum specified by the order code without advance notice. Shipments will always adhere to the chromaticity bin restrictions specified by the order code.

RELATIVE SPECTRAL POWER DISTRIBUTION

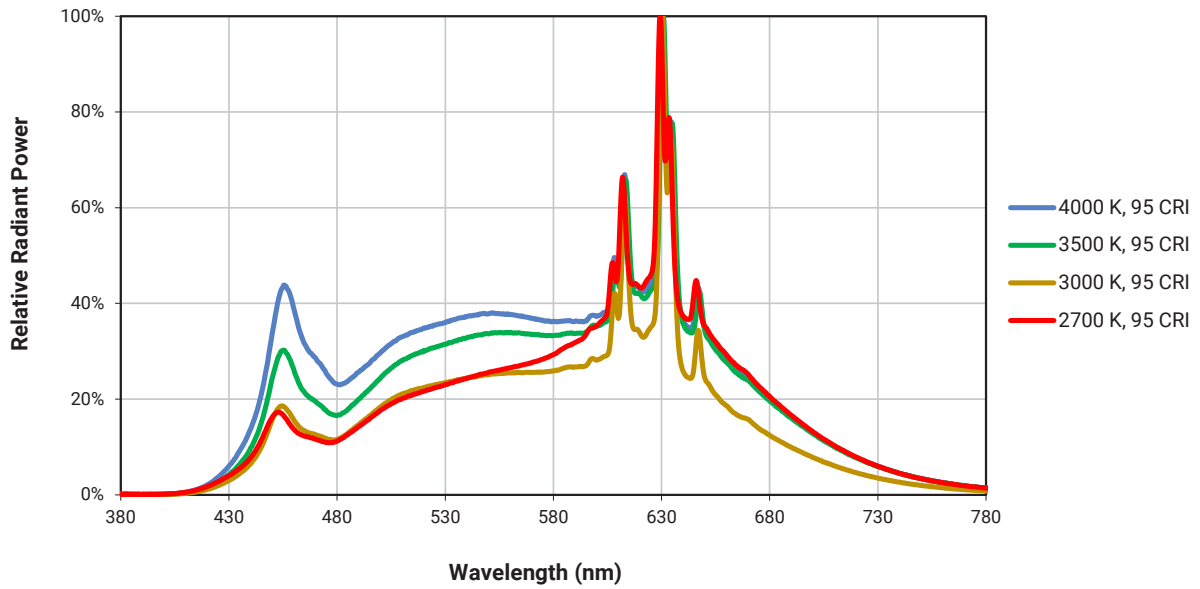
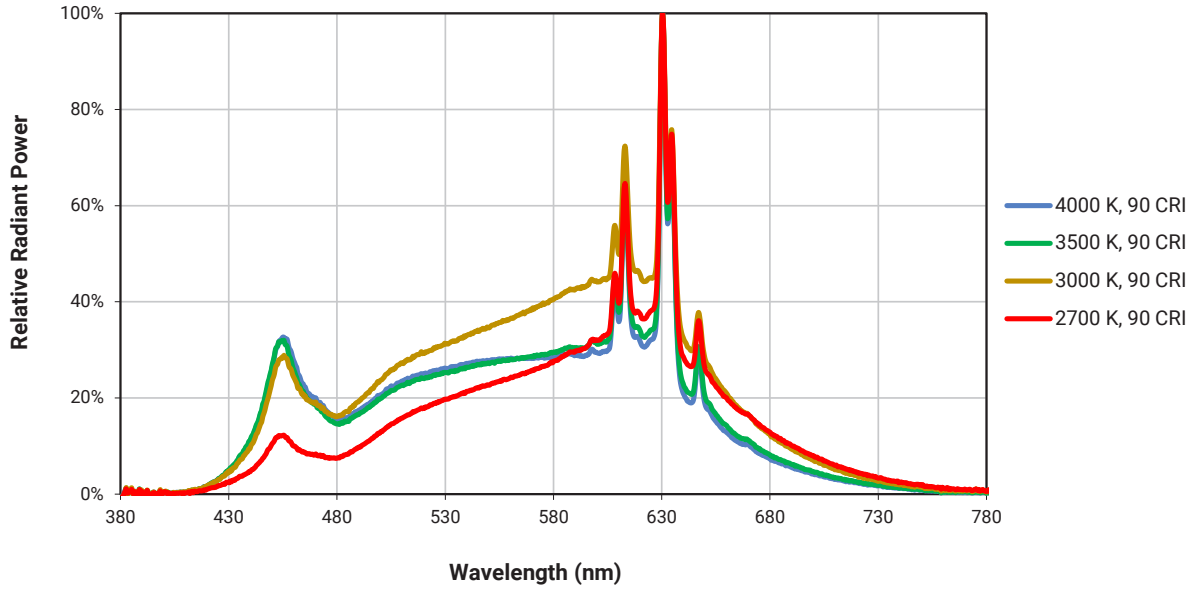

**RELATIVE FLUX VS. JUNCTION TEMPERATURE ( $I_f = 350 \text{ mA}$ )**

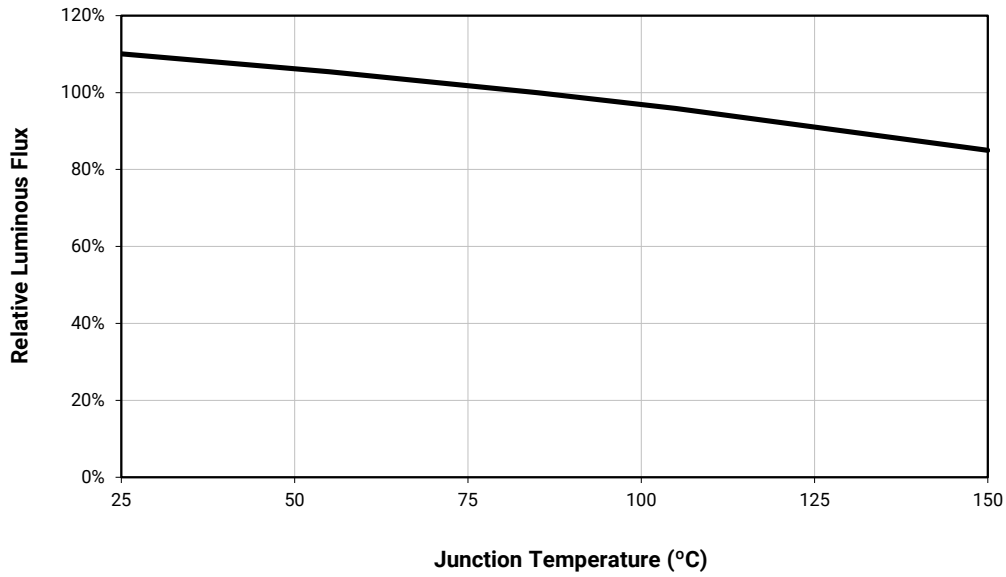

**ELECTRICAL CHARACTERISTICS ( $T_j = 85 \text{ °C}$ )**

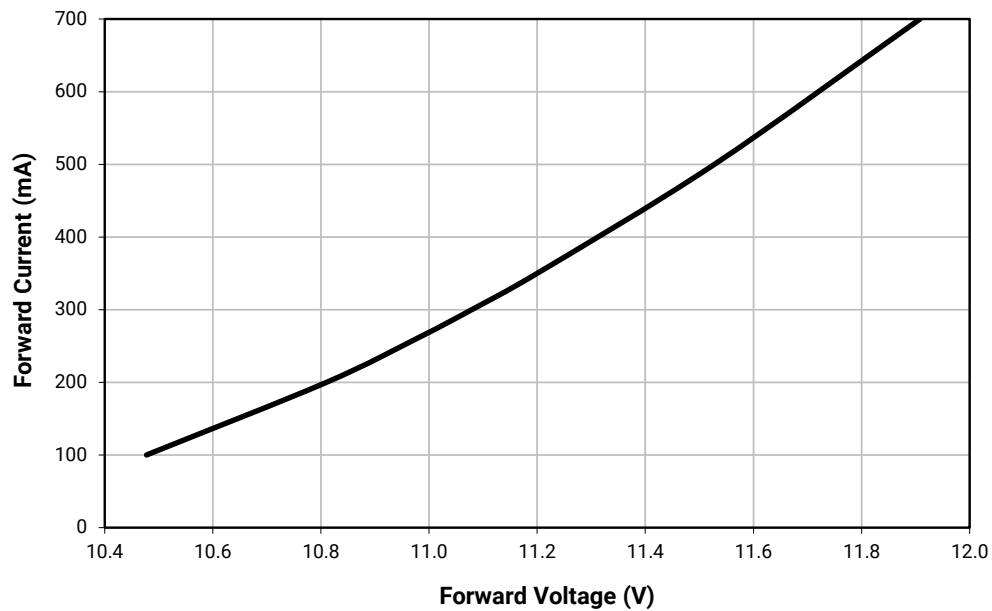

RELATIVE FLUX VS. CURRENT ( $T_j = 85\text{ }^\circ\text{C}$ )

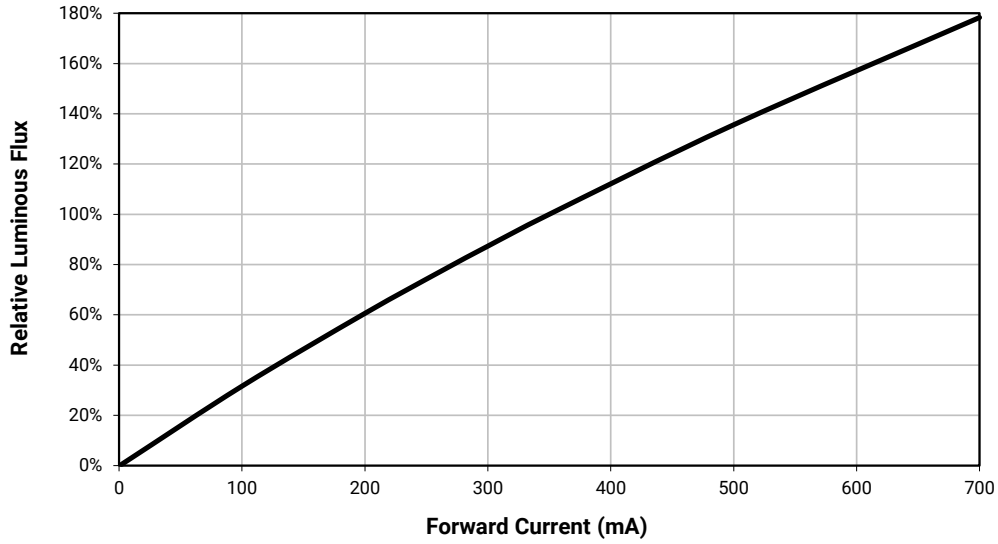

### RELATIVE CHROMATICITY VS. CURRENT (WARM WHITE)

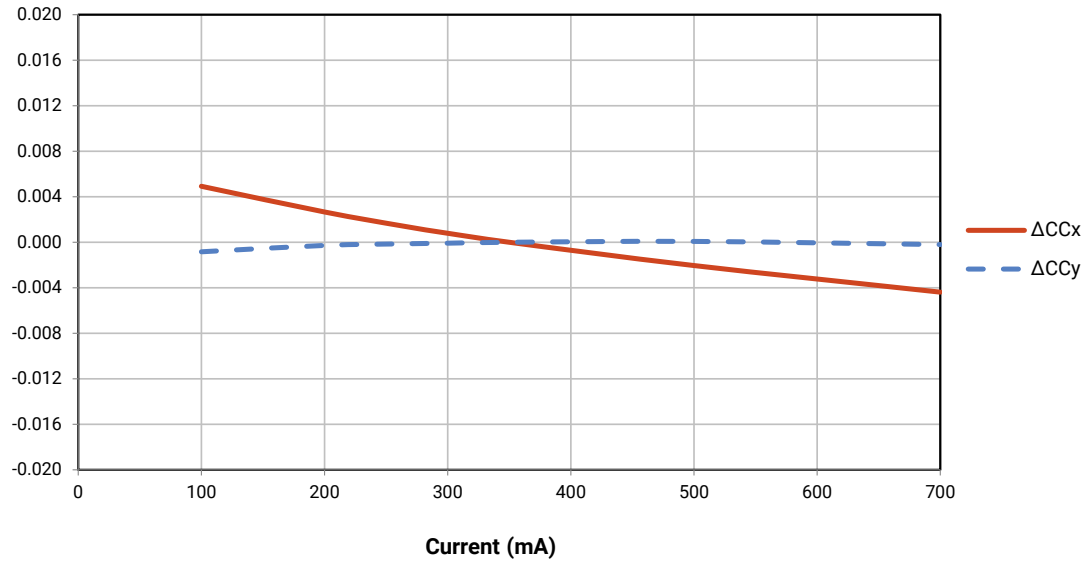

### RELATIVE CHROMATICITY VS. TEMPERATURE (WARM WHITE)

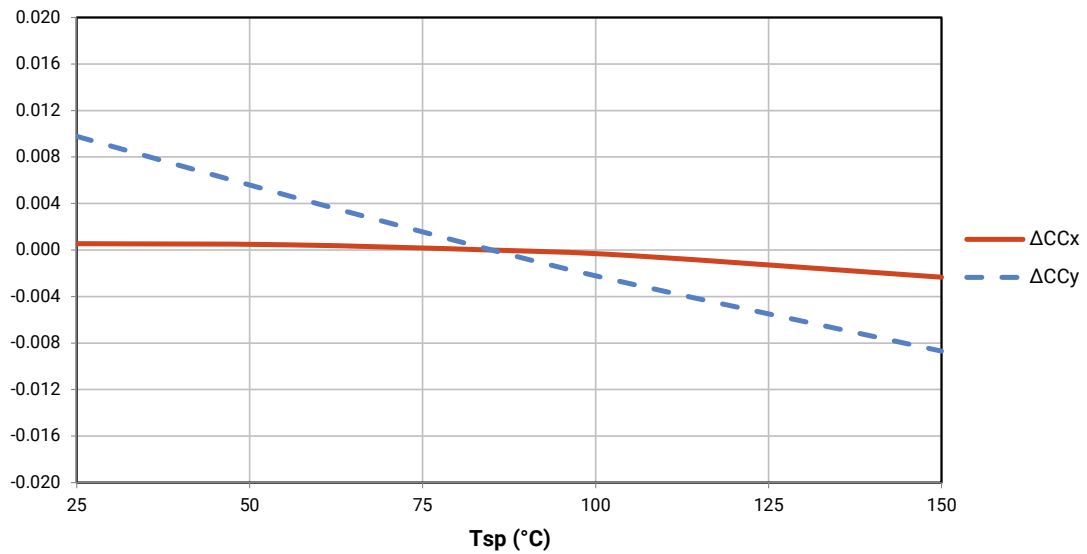

## TYPICAL SPATIAL DISTRIBUTION

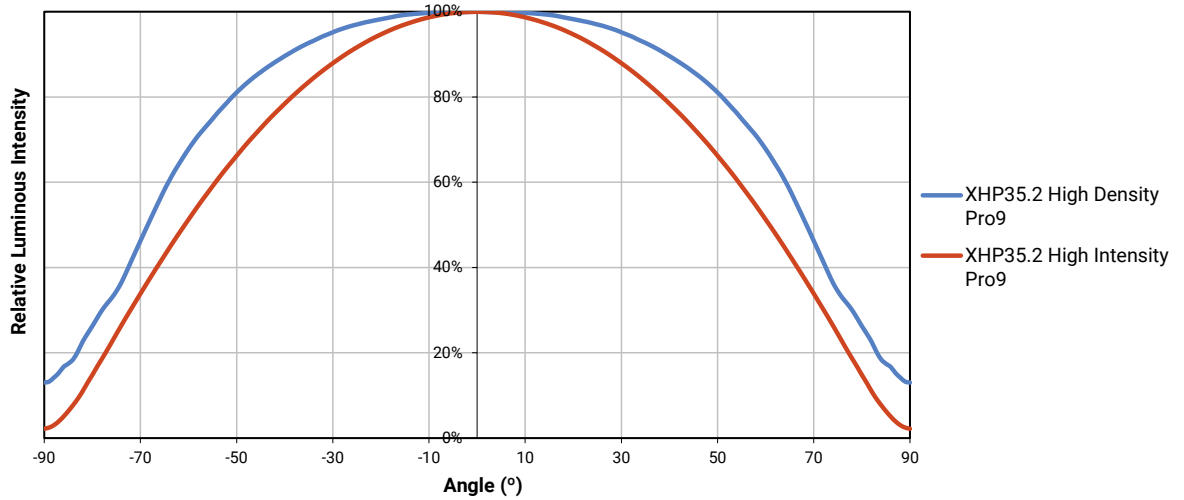

## THERMAL DESIGN

The maximum forward current is determined by the thermal resistance between the LED junction and ambient. It is crucial for the end product to be designed in a manner that minimizes the thermal resistance from the solder point to ambient in order to optimize lamp life and optical characteristics.

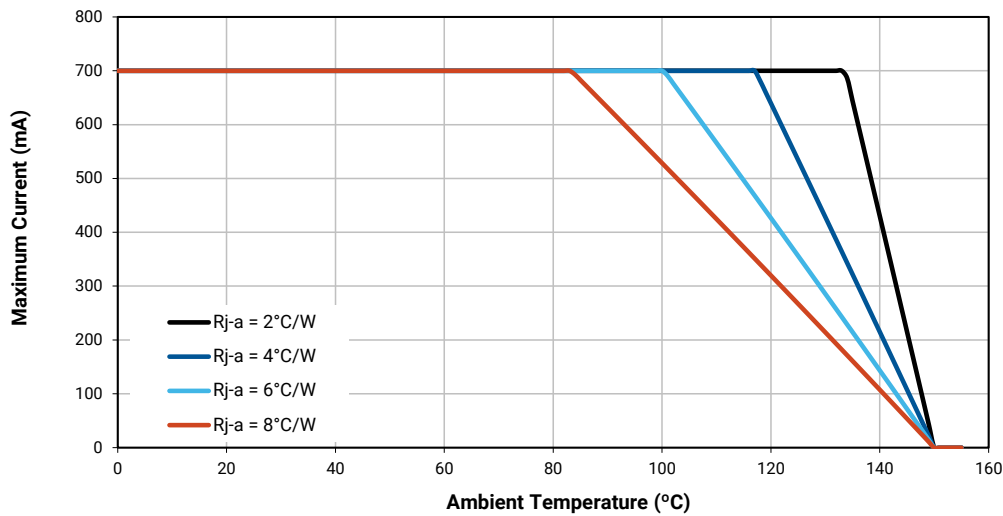

## PERFORMANCE GROUPS - LUMINOUS FLUX ( $T_j = 85\text{ °C}$ )

XLamp XHP35.2 Pro9 LEDs are tested for luminous flux and placed into one of the following luminous-flux groups.

Group Code	Minimum Luminous Flux (lm) @ 350 mA	Maximum Luminous Flux (lm) @ 350 mA
A4	355	380
B2	380	410
B4	410	440
C2	440	475
C4	475	510
D2	510	550
D4	550	590

## PERFORMANCE GROUPS - CHROMATICITY

XLamp XHP35.2 Pro9 LEDs are tested for chromaticity and placed into one of the regions defined by the following bounding coordinates.

EasyWhite Color Temperatures – 2-Step			
Bin Code	CCT	x	y
40H	4000 K	0.3777	0.3739
		0.3797	0.3816
		0.3861	0.3855
		0.3838	0.3777
35H	3500 K	0.4022	0.3858
		0.4053	0.3942
		0.4125	0.3977
		0.4091	0.3891
30H	3000 K	0.4287	0.3975
		0.4328	0.4064
		0.4390	0.4086
		0.4347	0.3996
27H	2700 K	0.4524	0.4048
		0.4574	0.4140
		0.4633	0.4154
		0.4581	0.4062

EasyWhite Color Temperatures – 3-Step Ellipse						
Bin Code	CCT	Center Point		Major Axis	Minor Axis	Rotation Angle (°)
		x	y	a	b	
40G	4000 K	0.3818	0.3797	0.00939	0.00402	53.7
35G	3500 K	0.4073	0.3917	0.00927	0.00414	54.0
30G	3000 K	0.4338	0.4030	0.00834	0.00408	53.2
27G	2700 K	0.4577	0.4099	0.00834	0.00420	48.5

EASYWHITE® CHROMATICITY REGIONS PLOTTED ON THE 1931 CIE CURVE

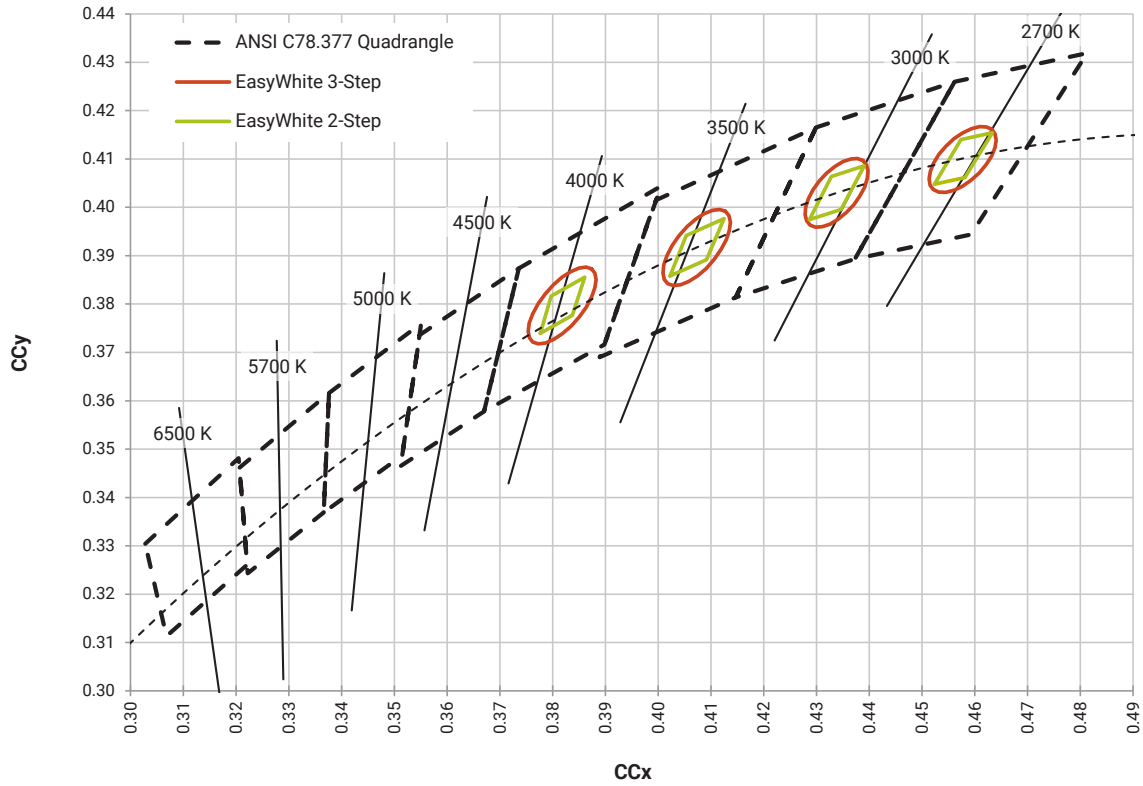

## BIN AND ORDER CODE FORMATS

Bin codes and order codes for XHP35.2 Pro9 LEDs are configured in the following manner:

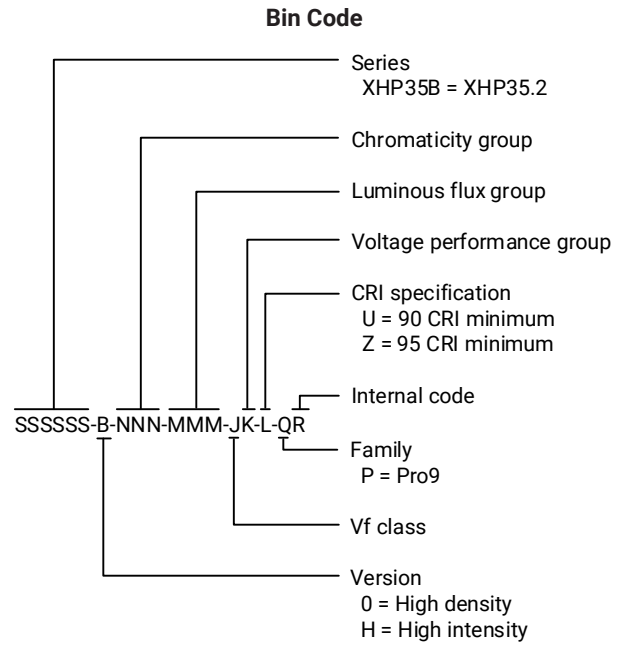
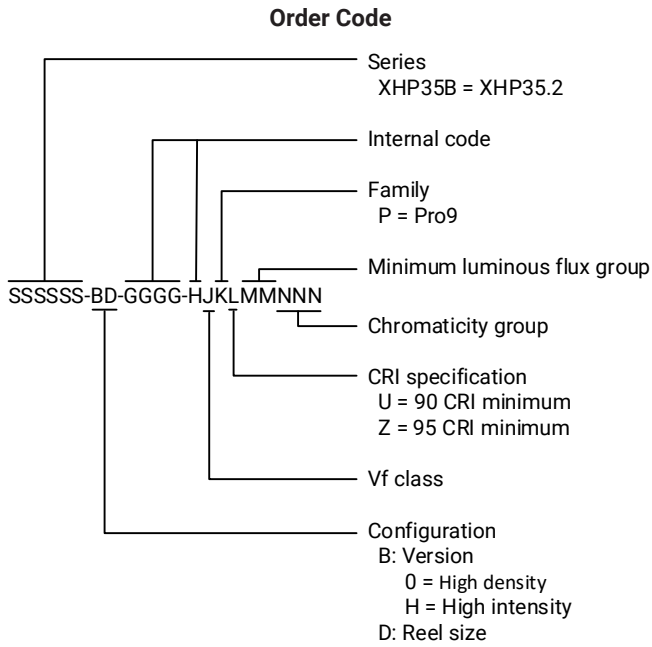

## REFLOW SOLDERING CHARACTERISTICS

In testing, Cree LED has found XLamp XHP35.2 Pro9 LEDs to be compatible with JEDEC J-STD-020C, using the parameters listed below. As a general guideline, Cree LED recommends that users follow the recommended soldering profile provided by the manufacturer of the solder paste used, and therefore it is the lamp or luminaire manufacturer’s responsibility to determine applicable soldering requirements.

Note that this general guideline may not apply to all PCB designs and configurations of reflow soldering equipment.

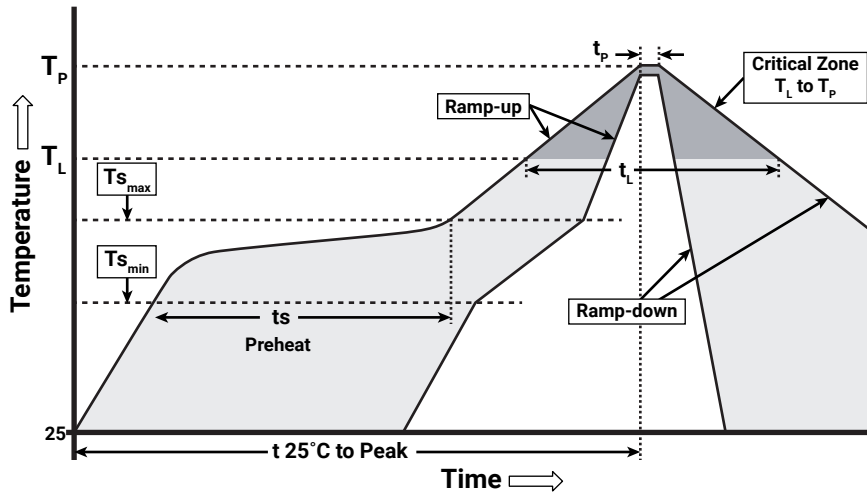

IPC/JEDEC J-STD-020C

Profile Feature	Lead-Free Solder
Average Ramp-Up Rate ( $T_{s_{max}}$ to $T_P$ )	1.2 °C/second
Preheat: Temperature Min ( $T_{s_{min}}$ )	120 °C
Preheat: Temperature Max ( $T_{s_{max}}$ )	170 °C
Preheat: Time ( $t_{s_{min}}$ to $t_{s_{max}}$ )	65-150 seconds
Time Maintained Above: Temperature ( $T_L$ )	217 °C
Time Maintained Above: Time ( $t_L$ )	45-90 seconds
Peak/Classification Temperature ( $T_P$ )	235 - 245 °C
Time Within 5 °C of Actual Peak Temperature ( $t_p$ )	20-40 seconds
Ramp-Down Rate	1 - 6 °C/second
Time 25 °C to Peak Temperature	4 minutes max.

Note: All temperatures refer to the topside of the package, measured on the package body surface.

## NOTES

---

### LED Use

Use of this LED in information displays utilizing LCD Backlights and other emissive pixel display technology is prohibited (“Use Restrictions”).

### Measurements

The luminous flux, radiant power, chromaticity, forward voltage and CRI measurements in this document are binning specifications only and solely represent product measurements as of the date of shipment. These measurements will change over time based on a number of factors that are not within Cree LED’s control and are not intended or provided as operational specifications for the products. Calculated values are provided for informational purposes only and are not intended or provided as specifications.

### Pre-Release Qualification Testing

Please read the [LED Reliability Overview](#) for details of the qualification process Cree LED applies to ensure long-term reliability for XLamp LEDs and details of Cree LED’s pre-release qualification testing for XLamp LEDs.

### Lumen Maintenance

Cree LED now uses standardized IES LM-80-08 and TM-21-11 methods for collecting long-term data and extrapolating LED lumen maintenance. For information on the specific LM-80 data sets available for this LED, refer to the public [LM-80 results document](#).

Please read the [Long-Term Lumen Maintenance application note](#) for more details on Cree LED’s lumen maintenance testing and forecasting. Please read the [Thermal Management application note](#) for details on how thermal design, ambient temperature, and drive current affect the LED junction temperature.

### Moisture Sensitivity

Cree LED recommends keeping XLamp LEDs in the provided, resealable moisture-barrier packaging (MBP) until immediately prior to soldering. Unopened MBPs that contain XLamp LEDs do not need special storage for moisture sensitivity.

Once the MBP is opened, XLamp XHP35.2 Pro9 LEDs may be stored as MSL 1 per JEDEC J-STD-033, meaning they have unlimited floor life in conditions of  $\leq 30$  °C/85% relative humidity (RH). Regardless of the storage condition, Cree LED recommends sealing any unsoldered LEDs in the original MBP.

### RoHS Compliance

The levels of RoHS restricted materials in this product are below the maximum concentration values (also referred to as the threshold limits) permitted for such substances, or are used in an exempted application, in accordance with EU Directive 2011/65/EC (RoHS2), as implemented January 2, 2013. RoHS Declarations for this product can be obtained from your Cree LED representative or from the [Product Ecology](#) section of the Cree LED website.

### REACH Compliance

REACH substances of very high concern (SVHCs) information is available for this product. Since the European Chemical Agency (ECHA) has published notice of their intent to frequently revise the SVHC listing for the foreseeable future, please contact a Cree LED

## NOTES - CONTINUED

---

representative to insure you get the most up-to-date REACH SVHC Declaration. REACH banned substance information (REACH Article 67) is also available upon request.

### **Vision Advisory**

**WARNING:** Do not look at an exposed lamp in operation. Eye injury can result. For more information about LEDs and eye safety, please refer to the [LED Eye Safety application note](#).

**MECHANICAL DIMENSIONS**

Thermal vias, if present, are not shown on these drawings.

All dimensions are  $\pm 0.13$  mm unless otherwise indicated.

**XHP35.2 High-Density Pro9**

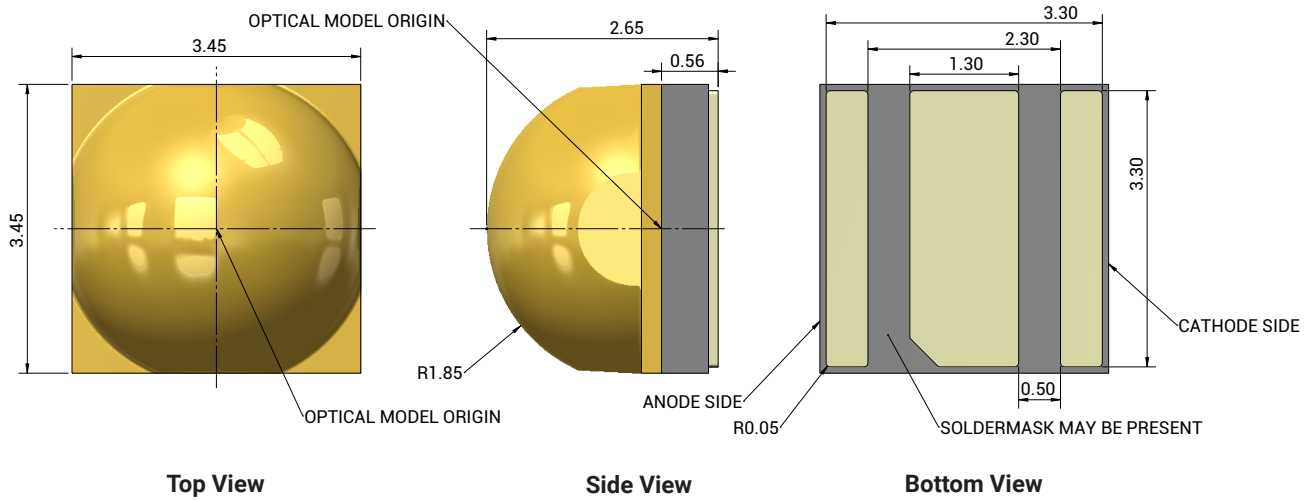

**XHP35.2 High-Intensity Pro9**

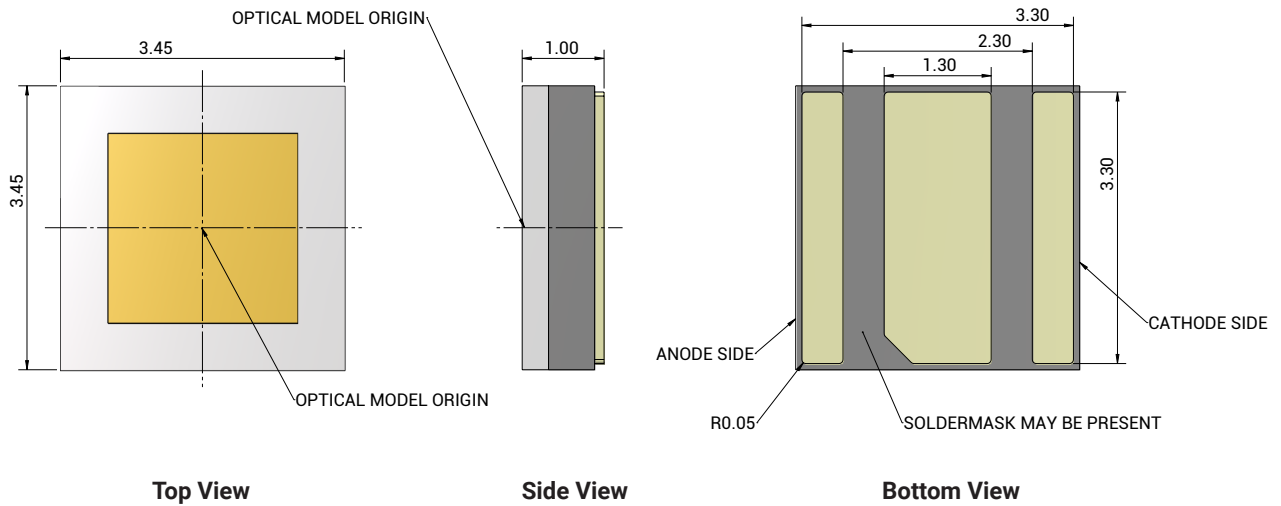

## MECHANICAL DIMENSIONS - CONTINUED

## XHP35.2 High-Density Pro9 and XHP35.2 High-Intensity Pro9

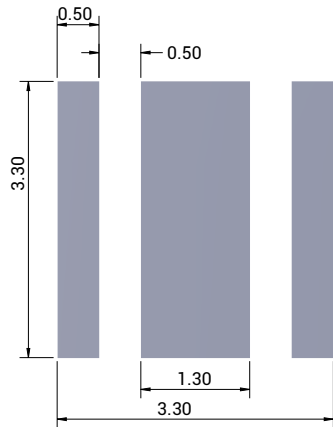

Recommended PCB Footprint

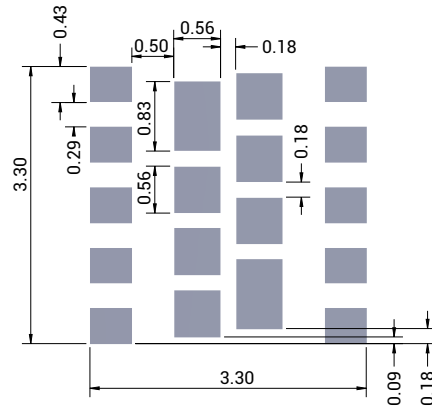

Recommended Stencil Openings\*

## Notes:

- Cree LED recommends using thermal pad kickouts to maximize component thermal performance.
- Cree LED recommends using white solder mask material to minimize system optical loss.
- \* This stencil has been tested and optimized for the avoidance of voiding when using ALPHA® LUMET® P30 Maxrel solder paste. For other solder pastes, a "window pane" design for the thermal pad stencil may result in a lower voiding percentage. Contact your local Cree LED Field Applications Engineer for consultation regarding your specific application.



**TAPE AND REEL - CONTINUED**

**XHP35.2 High-Density Pro9**

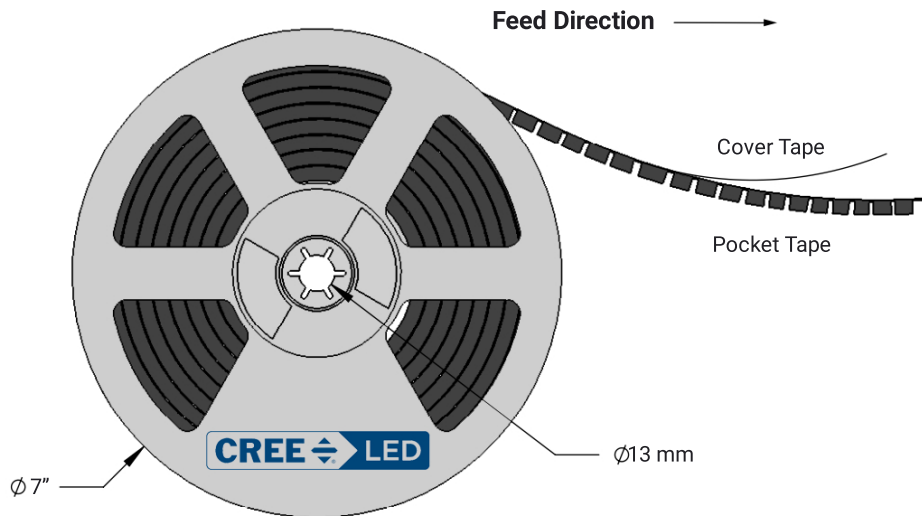
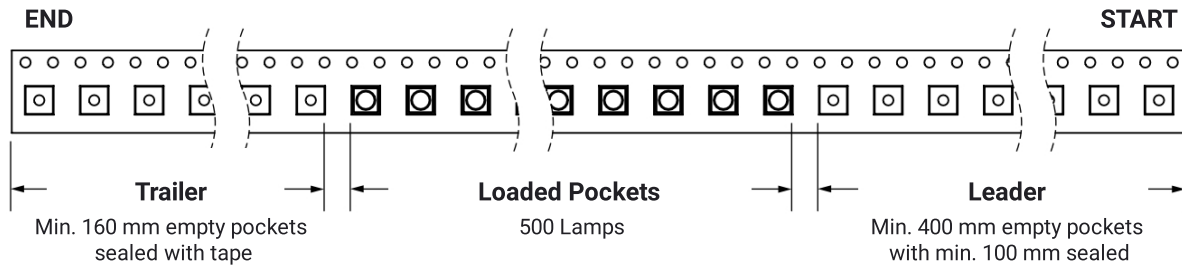

**TAPE AND REEL - CONTINUED**

**XHP35.2 High-Intensity Pro9**

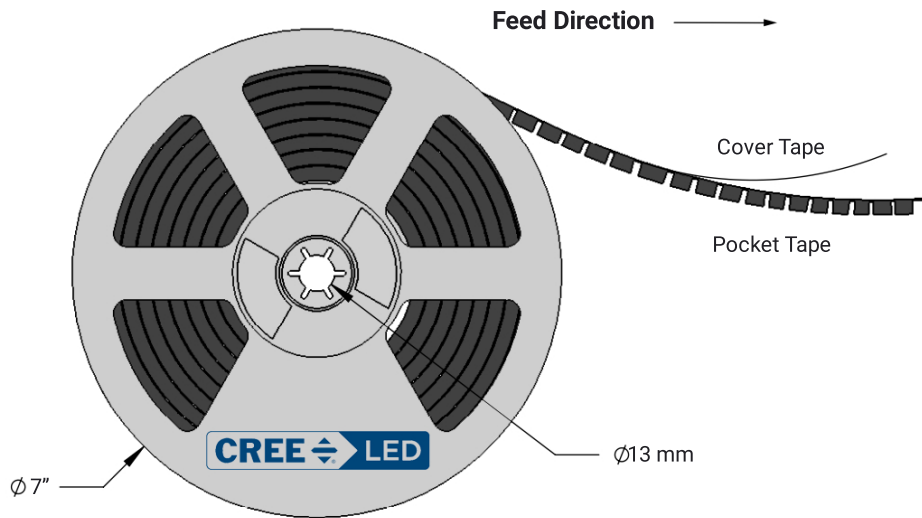
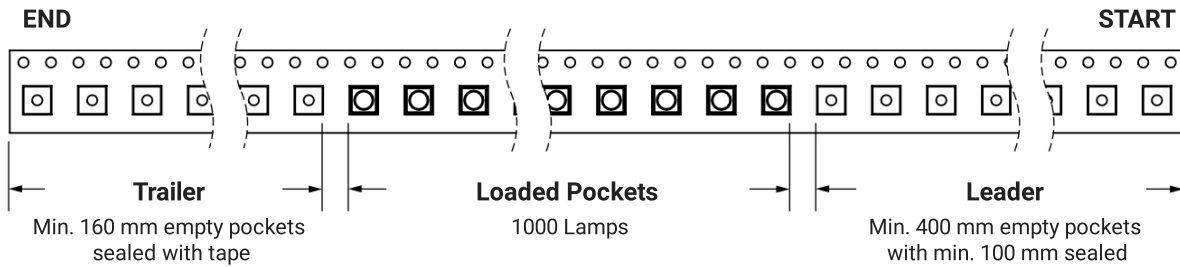

## PACKAGING

### Unpackaged Reel

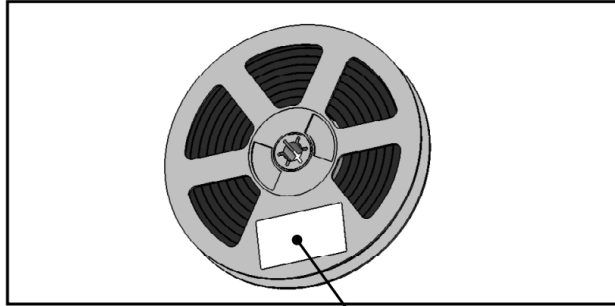

Label with Cree LED Bin Code, Quantity, Reel ID

### Packaged Reel

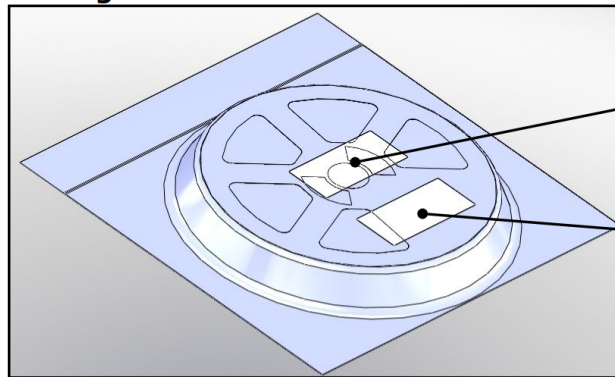

Label with Cree LED Order Code, Quantity, Reel ID, PO#

Label with Cree LED Bin Code, Quantity, Reel ID

### Boxed Reel

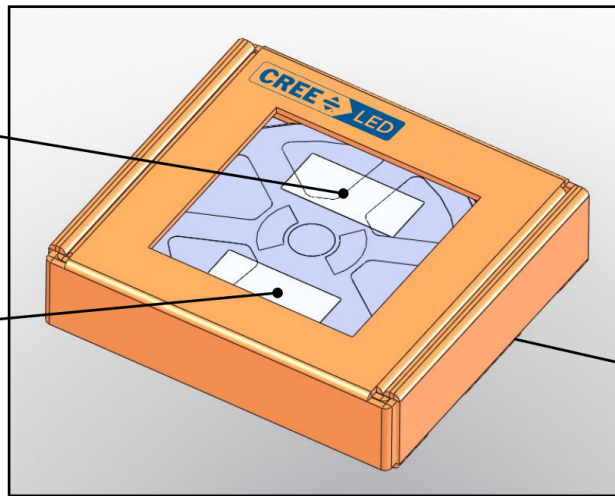

Label with Cree LED Order Code, Quantity, Reel ID, PO#

Label with Cree LED Bin Code, Quantity, Reel ID

Patent Label (on bottom of box)

## X-ON Electronics

Largest Supplier of Electrical and Electronic Components

*Click to view similar products for Cree manufacturer:*

Other Similar products are found below :

[C4SMA-BGF-CR2T3452](#) [C4SMA-BGF-CR34Q4S2](#) [C4SMA-BGY-CR2T3452](#) [C4SMA-BGY-CR34Q4S1](#) [C4SMA-GGF-CV14Q7C2](#)  
[C4SMA-GGY-CU2W37A1](#) [C4SMA-RGF-CS4V1BB1](#) [C4SMA-RGF-CT34QBB2](#) [C4SMA-RGY-CS4V1BB1](#) [C4SMA-RGY-CT24QBB2](#)  
[C4SMB-BGF-CT24Q3S2](#) [C4SMB-BGY-CT24Q4S1](#) [C4SMB-GGF-CX3Z4791](#) [C4SMB-GGF-CY14Q8S2](#) [C4SMB-RGF-CU4X1BB1](#)  
[C4SMB-RGY-CV14QBB1](#) [C4SMG-BJS-CQ0T0451](#) [C4SMG-BJS-CQ14Q4T1](#) [C4SMH-RJS-CR0T0BB1](#) [C4SMK-GJS-CU34Q8T2](#) [C4SMM-](#)  
[BJF-CP14Q3C1](#) [C4SMM-GJF-CT2V1791](#) [C4SMM-GJF-CT44Q7C1](#) [C4SMM-GJF-CT44Q7C2](#) [C4SMM-RJF-CS24QBB2](#) [C4SMN-GJF-](#)  
[CW24Q7C2](#) [C503B-AAN-CA0B0341](#) [C503B-AAN-CA0C0252-015](#) [C503B-AAN-CA0C0341-015](#) [C503B-AAN-CA0C0342-015](#) [C503B-](#)  
[AAN-CY0B0251](#) [C503B-AAN-CY0B0252](#) [C503B-AAN-CZ0B0342](#) [C503B-AAS-CA0B0341](#) [C503B-AAS-CA0C0251-015](#) [C503B-AAS-](#)  
[CA0C0252-015](#) [C503B-AAS-CA0C0341-015](#) [C503B-AAS-CY0B0251](#) [C503B-AAS-CY0B0252](#) [C503B-AAS-CZ0B0342](#) [C503B-ABN-](#)  
[CW0Z0251](#) [C503B-ABN-CW0Z0252](#) [C503B-ABN-CX0Y0341](#) [C503B-ABN-CX0Y0342](#) [C503B-ABN-CY0Z0341](#) [C503B-ABN-CY0Z0342](#)  
[C503B-ABS-CW0Z0251](#) [C503B-ABS-CX0Y0342](#) [C503B-ACN-CX0Y0251](#) [C503B-ACN-CX0Y0341](#)