

J Series® JR5050C 6-V E Class LEDs

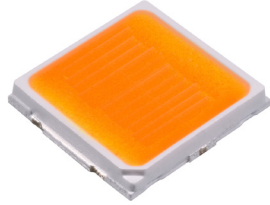

PRODUCT DESCRIPTION

The third-generation J Series® JR5050C LED sets a new industry benchmark for light output and efficacy in a standard, high-reliability package. JR5050C LEDs enable up to 70% reduction in LED count at the same delivered LPW when compared to other available 5050 LEDs. This part count reduction enables radical cost savings for high-LPW luminaire designs by also reducing PCB, optic and heat sink costs.

J Series 5050 LEDs are optimized for medium-density lighting applications where high efficacy and long lifetime are critical, such as street lights, outdoor area and indoor directional lights.

FEATURES

- Industry-compatible size: 5.0 x 5.2 x 0.75 mm
- 6-V configuration
- Flux binned at 25 °C, chromaticity binned at 85 °C
- 6500 K–2200 K ANSI CCTs available
- 70, 80 & 90 CRI available for all CCTs
- RoHS and REACH compliant
- UL® recognized component (E495478)

PRODUCT SUMMARY

Product	Power Class	Test Temperature	Test Current	Typical Forward Voltage	4000 K, 70 CRI		Maximum Current
					Typical Flux	Typical Efficacy	
JR5050C 6-V E Class	5 W	25 °C	400 mA	5.63 V	480 lm	213 LPW	1000 mA



J Series® Products are sold exclusively by Cree Venture LED Company Limited (“Cree Venture”), regardless of geography. Any orders for J Series Products that are submitted to Cree LED or any of its other subsidiaries will be directed to Cree Venture for acknowledgment and order fulfillment.

Cree LED / 4001 E. Hwy. 54, Suite 2000 / Durham, NC 27709 USA / +1.919.313.5330 / www.cree-led.com

TABLE OF CONTENTS

Order Code & Bin Code Formats	3
Characteristics	4
Operating Limits.....	4
Flux Characteristics, Order Codes and Bins	5
Relative Luminous Flux vs. Current.....	6
Electrical Characteristics.....	6
Relative Chromaticity vs. Current.....	7
Relative Chromaticity vs. Junction Temperature	7
Relative Luminous Flux vs. Junction Temperature	8
Typical Spatial Distribution.....	8
Relative Spectral Power Distribution	9
Performance Groups - Luminous Flux	10
Performance Groups - Forward Voltage.....	10
Performance Groups - Chromaticity	11
Reflow Soldering Characteristics.....	20
Notes	21
Mechanical Dimensions	23
Tape & Reel.....	24
Packaging.....	25

ORDER CODE & BIN CODE FORMATS

Order codes and bin codes for J Series 5050 LEDs are configured in the following manner:

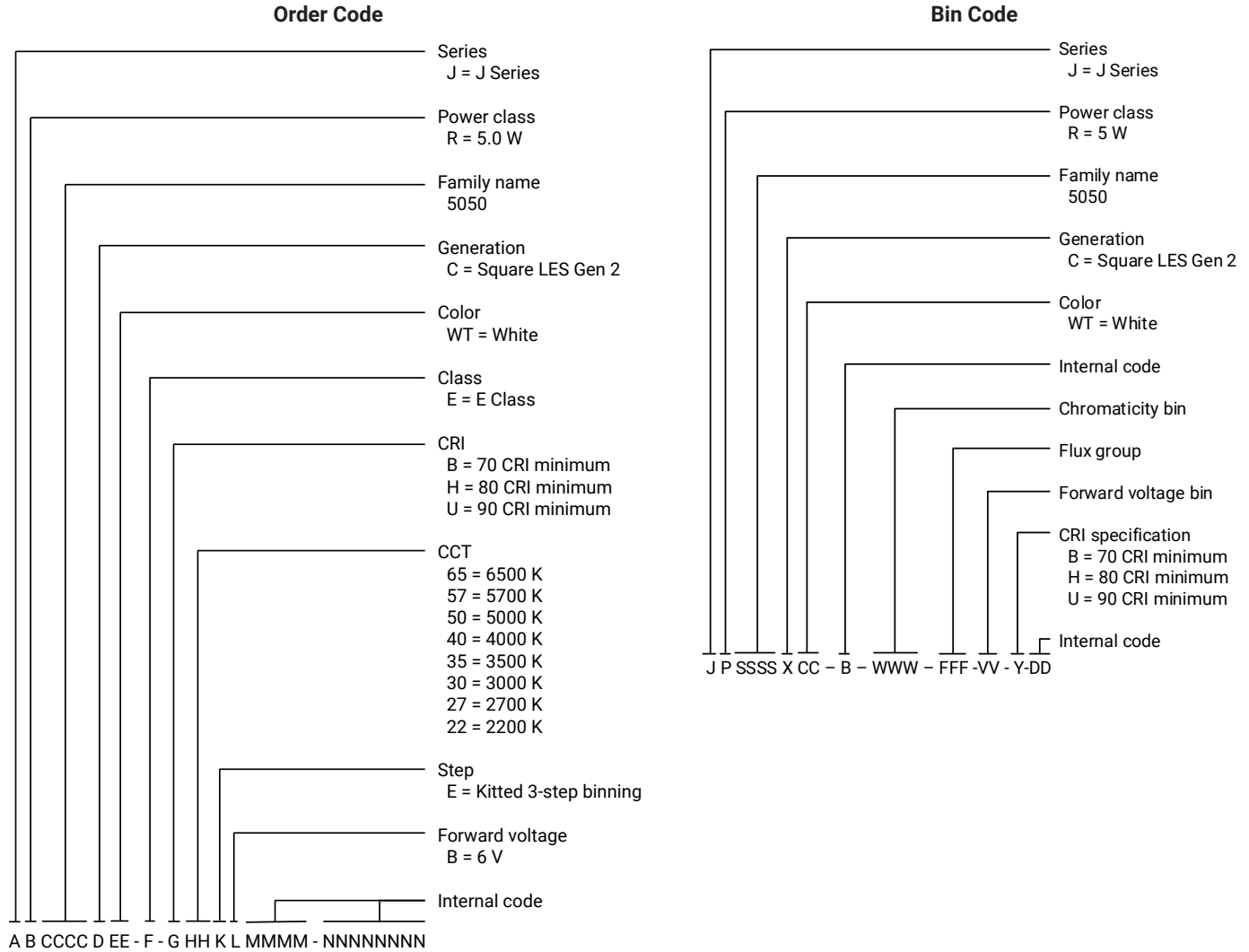

CHARACTERISTICS

Characteristics	Unit	Minimum	Typical	Maximum
Thermal resistance, junction to solder point	°C/W		1.2	
Viewing angle (FWHM)	degrees		120	
Temperature coefficient of voltage	mV/°C		-1.6	
ESD withstand voltage (HBM per Mil-Std-883L)			Class 2	
DC forward current	mA			1000
Reverse voltage	V			5
Forward voltage (@ 400 mA, 25 °C)	V		5.63	6.0
LED junction temperature	°C			125
Operating temperature	°C	-40		105

Notes

- Thermal resistance measurement was performed per the JEDEC JESD51-14 standard. See the [Thermal Resistance Measurement application note](#) for more details.
- Continuous reverse voltage can cause LED damage.

OPERATING LIMITS

The maximum forward current is determined by the thermal resistance between the LED junction and ambient.

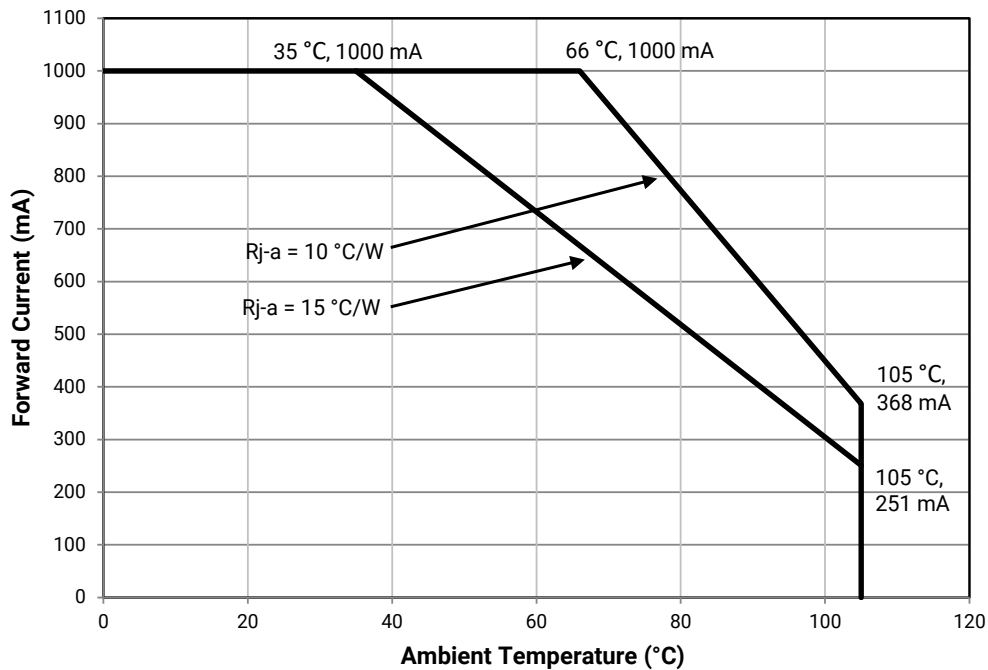

FLUX CHARACTERISTICS, ORDER CODES AND BINS ($I_F = 400 \text{ mA}$, $T_j = 25 \text{ }^\circ\text{C}$)

The following table provides order codes for J Series JR5050C 6-V E Class LEDs. For a complete description of the order code nomenclature, please see the Order Code and Bin Code Formats section (page 3). For definitions of the chromaticity kits, please see the Performance Groups - Chromaticity section (page 11).

Nominal CCT	Minimum CRI	Minimum Luminous Flux (lm) @ 25 °C	Typical Luminous Flux (lm) @ 25 °C	Typical Luminous Flux (lm) @ 85 °C*	Kitted 3-Step Order Code**
6500 K	70	400	472	444	JR5050CWT-E-B65EB0000-N0000001
	80	350	443	417	JR5050CWT-E-H65EB0000-N0000001
	90	300	374	352	JR5050CWT-E-U65EB0000-N0000001
5700 K	70	450	480	451	JR5050CWT-E-B57EB0000-N0000001
	80	350	448	421	JR5050CWT-E-H57EB0000-N0000001
	90	300	376	354	JR5050CWT-E-U57EB0000-N0000001
5000 K	70	450	480	451	JR5050CWT-E-B50EB0000-N0000001
	80	350	448	421	JR5050CWT-E-H50EB0000-N0000001
	90	300	376	354	JR5050CWT-E-U50EB0000-N0000001
4000 K	70	450	480	451	JR5050CWT-E-B40EB0000-N0000001
	80	350	448	421	JR5050CWT-E-H40EB0000-N0000001
	90	300	376	354	JR5050CWT-E-U40EB0000-N0000001
3500 K	70	400	465	437	JR5050CWT-E-B35EB0000-N0000001
	80	350	436	410	JR5050CWT-E-H35EB0000-N0000001
	90	300	365	343	JR5050CWT-E-U35EB0000-N0000001
3000 K	70	400	448	421	JR5050CWT-E-B30EB0000-N0000001
	80	350	424	399	JR5050CWT-E-H30EB0000-N0000001
	90	300	355	334	JR5050CWT-E-U30EB0000-N0000001
2700 K	70	350	432	406	JR5050CWT-E-B27EB0000-N0000001
	80	350	408	384	JR5050CWT-E-H27EB0000-N0000001
	90	300	345	325	JR5050CWT-E-U27EB0000-N0000001
2200 K	70	300	380	357	JR5050CWT-E-B22EB0000-N0000001
	80	300	350	329	JR5050CWT-E-H22EB0000-N0000001
	90	250	295	277	JR5050CWT-E-U22EB0000-N0000001

Notes:

- Cree Venture maintains a tolerance of $\pm 7\%$ on flux and power measurements, ± 0.005 on chromaticity (CCx, CCy) measurements and ± 2 on CRI measurements. See the Measurements section (page 21).
- Cree Venture J Series JR5050C 6-V E Class LED order codes specify only a minimum flux bin and not a maximum. Cree Venture may ship reels in flux bins higher than the minimum specified by the order code without advance notice. Shipments will always adhere to the chromaticity restrictions specified by the order code.
- * Flux values @ 85 °C are calculated and for reference only.
- ** Contact your Cree sales representative for kitted 3-step order code details.

RELATIVE LUMINOUS FLUX VS. CURRENT

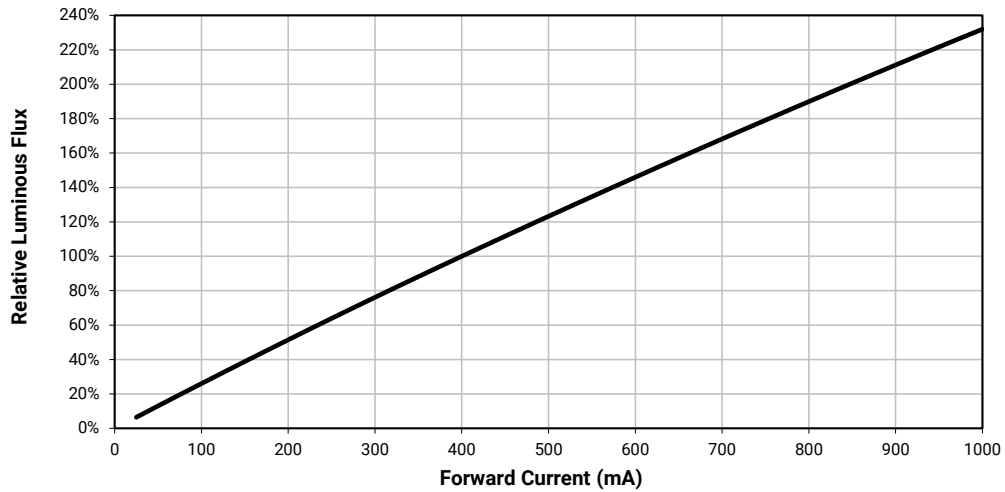

ELECTRICAL CHARACTERISTICS

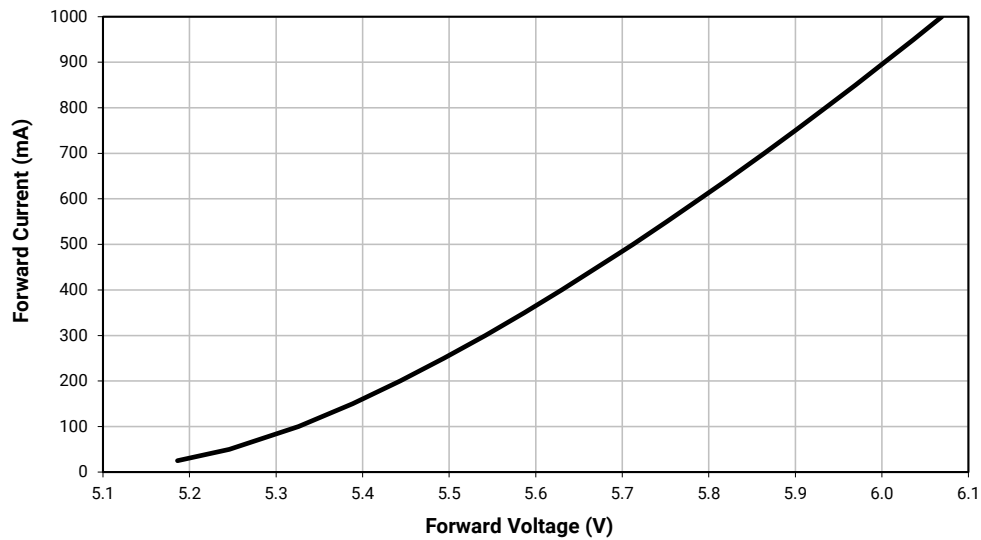

RELATIVE CHROMATICITY VS. CURRENT

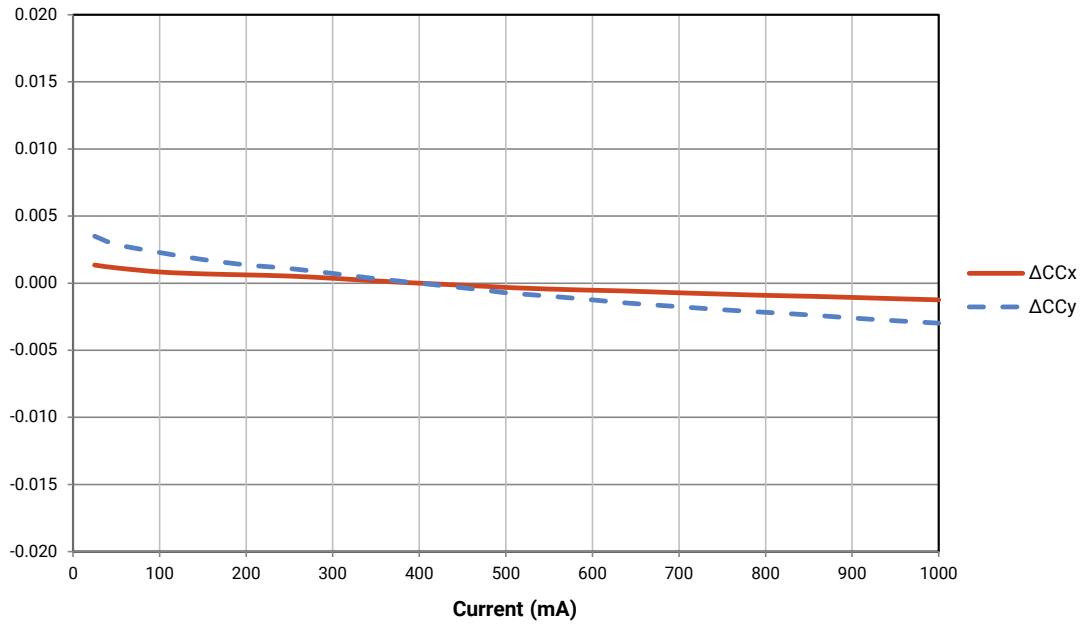

RELATIVE CHROMATICITY VS. JUNCTION TEMPERATURE

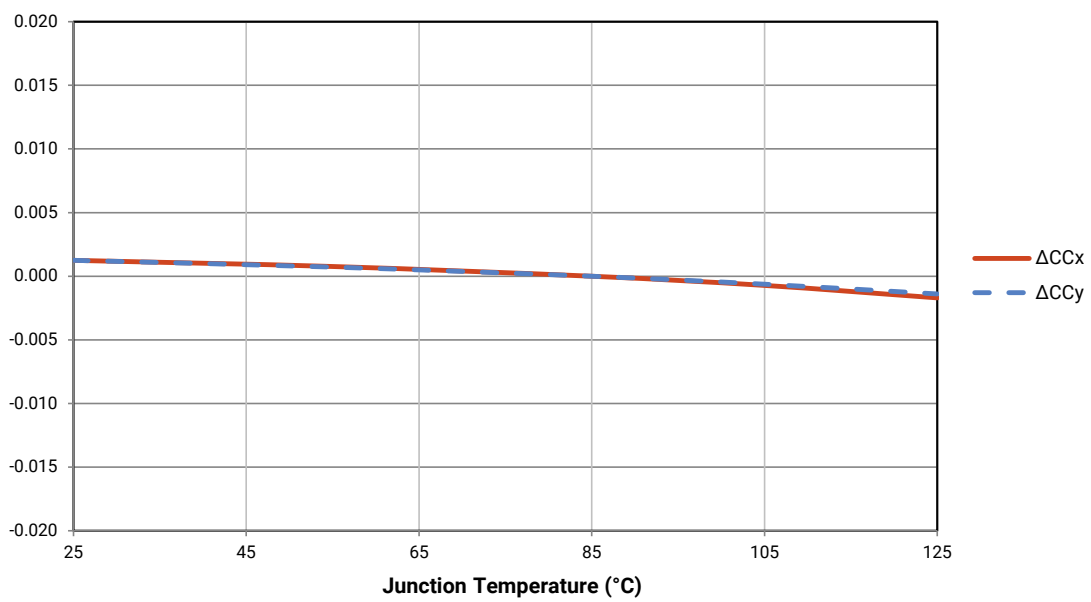

RELATIVE LUMINOUS FLUX VS. JUNCTION TEMPERATURE

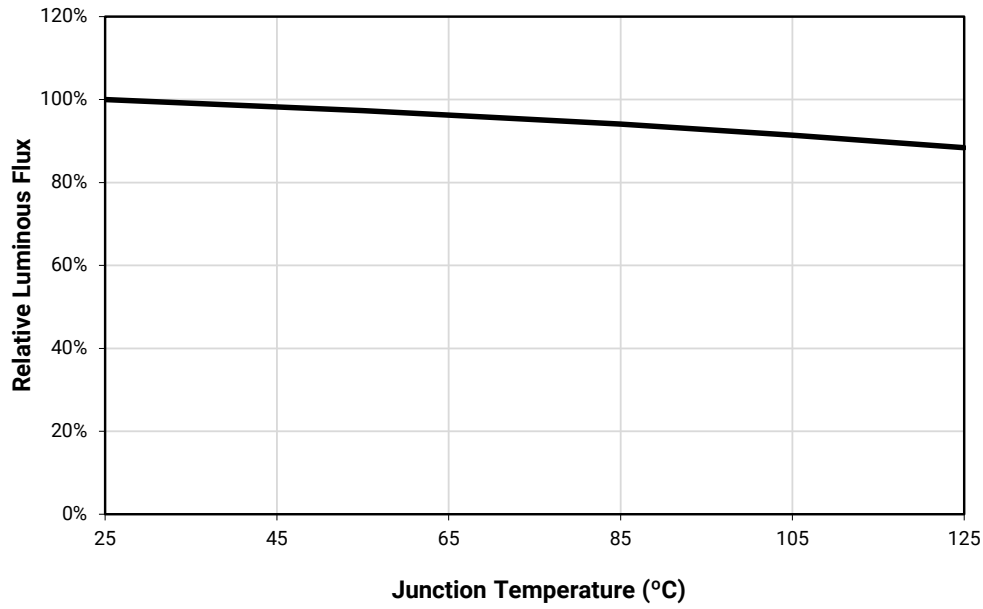

TYPICAL SPATIAL DISTRIBUTION

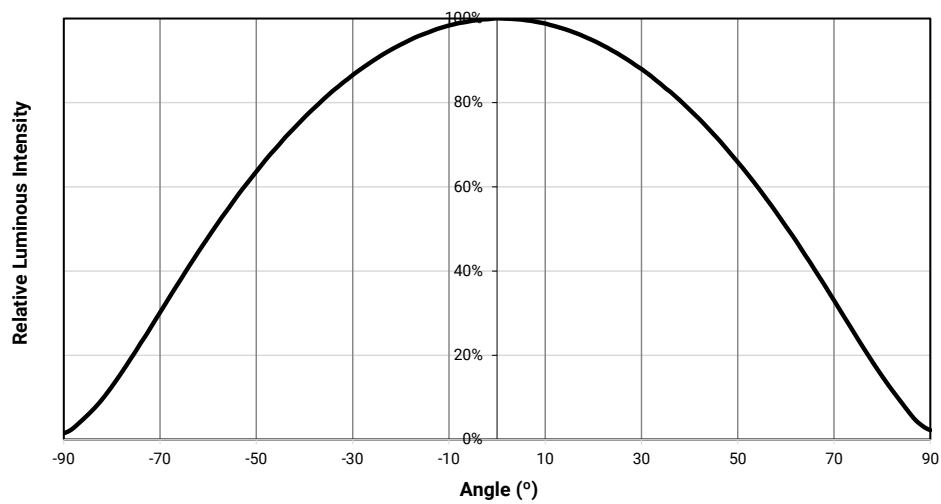

RELATIVE SPECTRAL POWER DISTRIBUTION

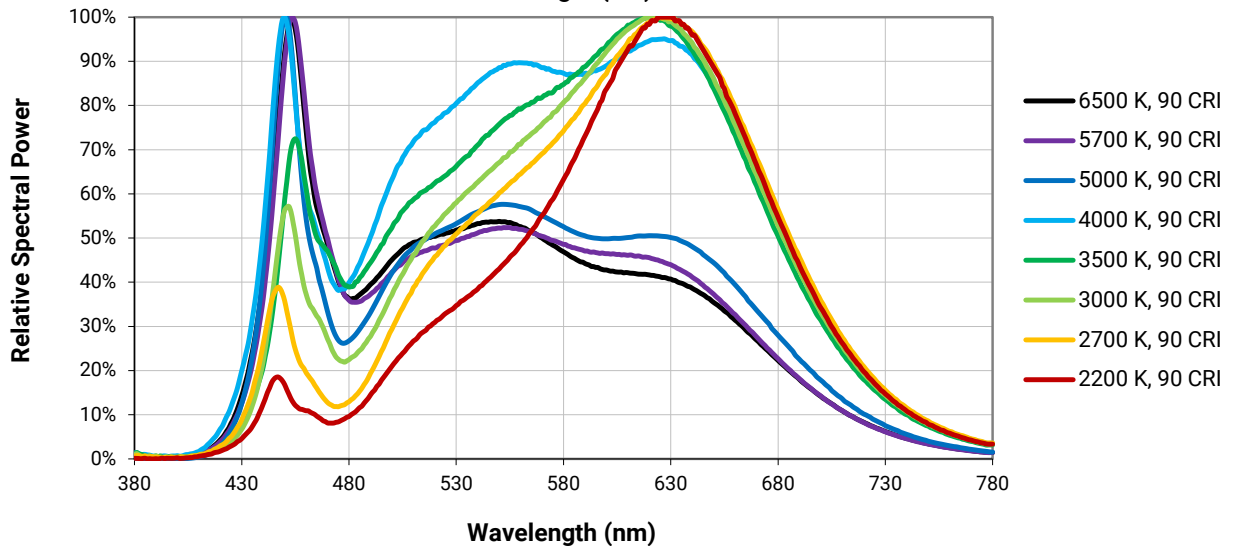
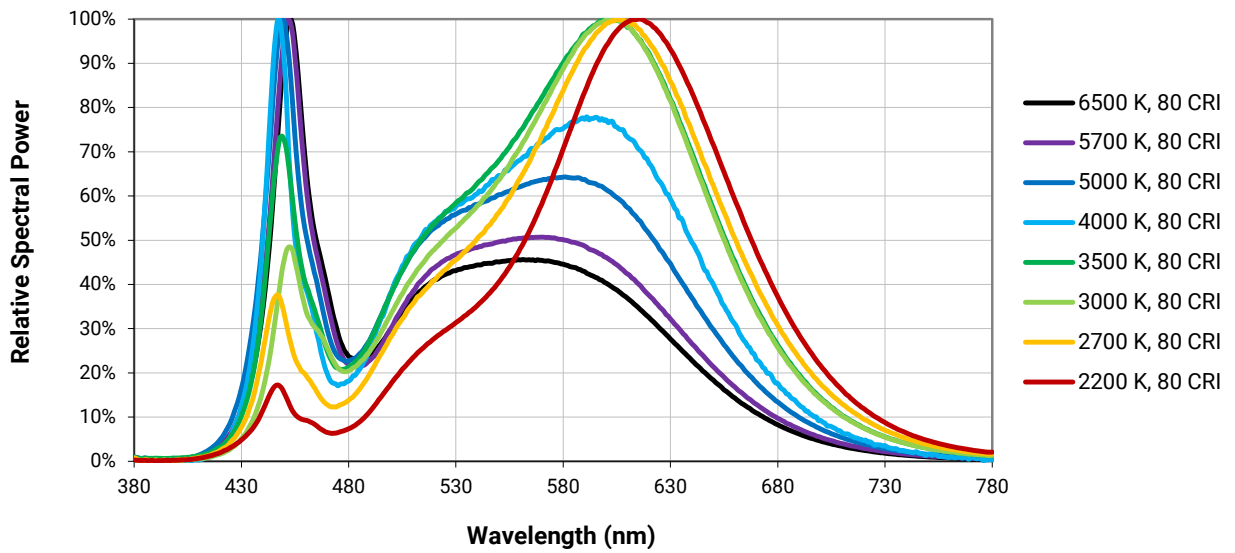
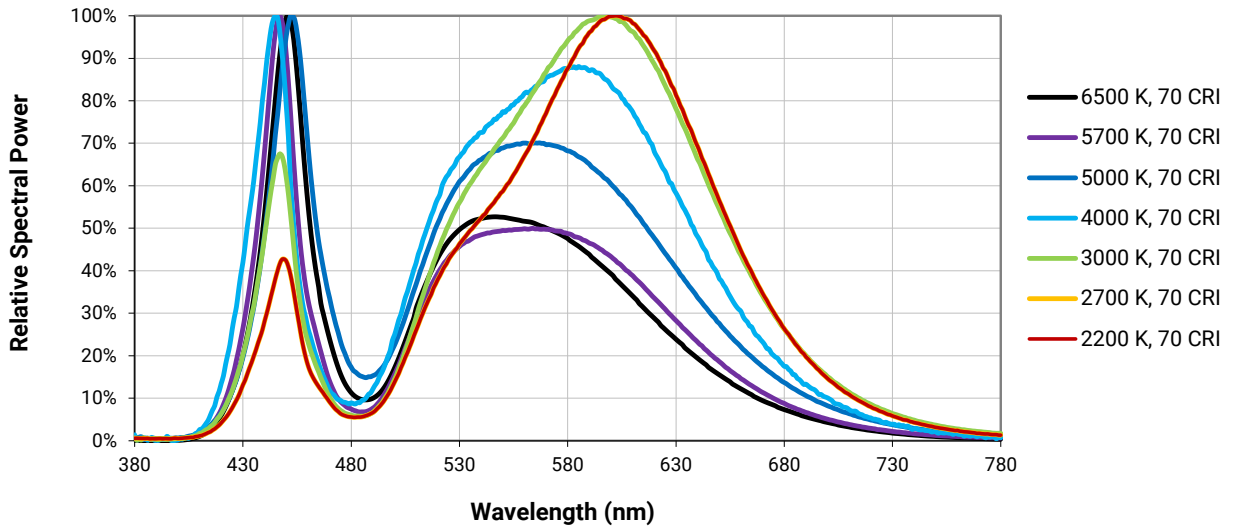

PERFORMANCE GROUPS - LUMINOUS FLUX ($T_j = 25\text{ }^\circ\text{C}$)

J Series JR5050 LEDs are tested for luminous flux at the following current level.

JR5050 LED	Tested For Luminous Flux At
6 V	400 mA

Once tested, J Series JR5050C 6-V E Class LEDs are placed into one of the following luminous-flux groups.

Group Code	Minimum Luminous Flux (lm)	Maximum Luminous Flux (lm)
P4	250	300
Q2	300	350
Q4	350	400
R2	400	450
R4	450	500
S2	500	550

PERFORMANCE GROUPS - FORWARD VOLTAGE ($T_j = 25\text{ }^\circ\text{C}$)

J Series 5050 LEDs are tested for forward voltage and placed into one of the following voltage bins.

The following voltage bins are indicated in the Forward Voltage Bin field in the bin code for JR5050C 6-V E Class LEDs.

Voltage Bin	Minimum Forward Voltage (V)	Maximum Forward Voltage (V)
BM	5.4	5.6
BN	5.6	5.8
BP	5.8	6

PERFORMANCE GROUPS - CHROMATICITY ($T_j = 85\text{ }^\circ\text{C}$)

J Series 5050 LEDs are tested for chromaticity and placed into one of the regions defined by the following bounding coordinates.

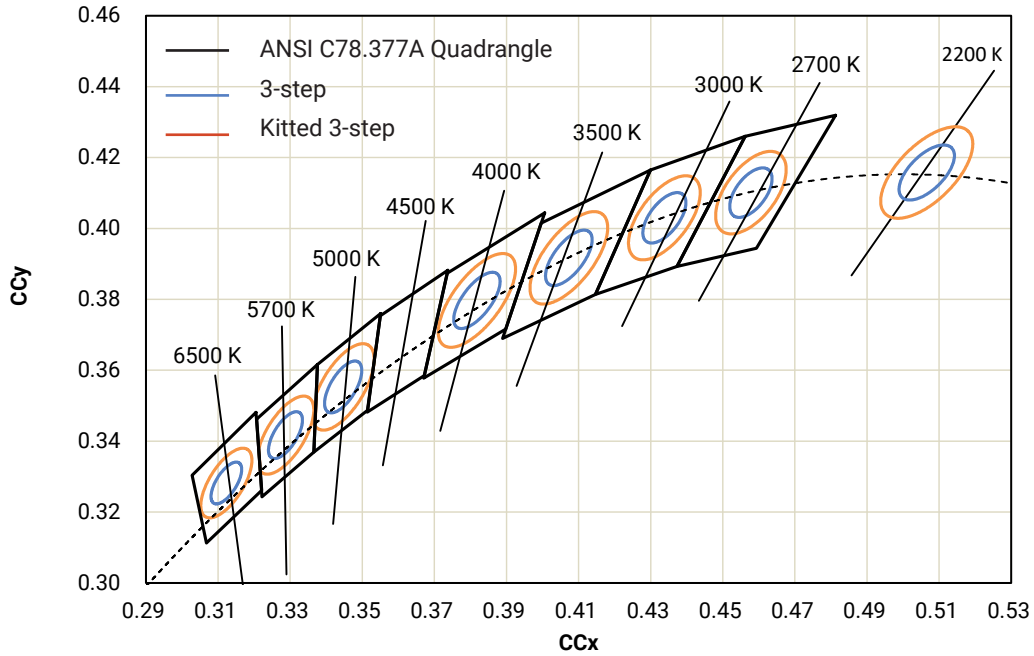

PERFORMANCE GROUPS - CHROMATICITY - CONTINUED ($T_j = 85\text{ }^\circ\text{C}$)

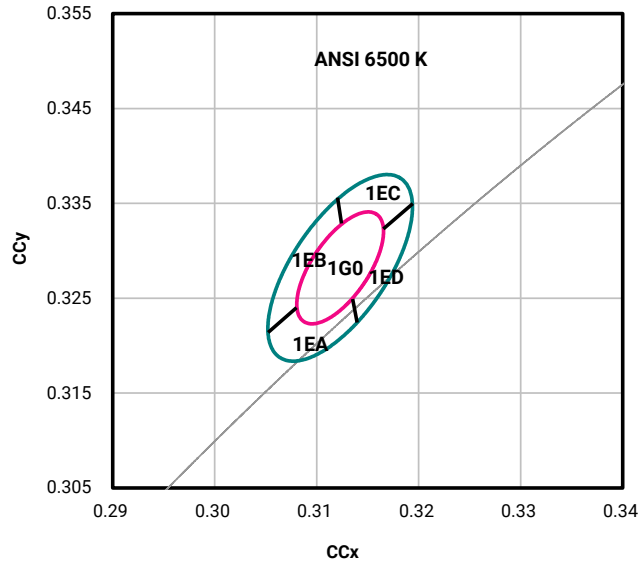

CCT	MacAdam Ellipse	Included Bins	Center Point		Major Axis	Minor Axis	Rotation Angle (°)
			x	y	a	b	
6500 K	3-step	1G0	0.3123	0.3282	0.00669	0.00285	58.57
	Kitted 3-step	1G0, 1EA, 1EB, 1EC, 1ED	0.3123	0.3282	0.01115	0.00475	58.57

PERFORMANCE GROUPS - CHROMATICITY - CONTINUED ($T_j = 85\text{ }^\circ\text{C}$)

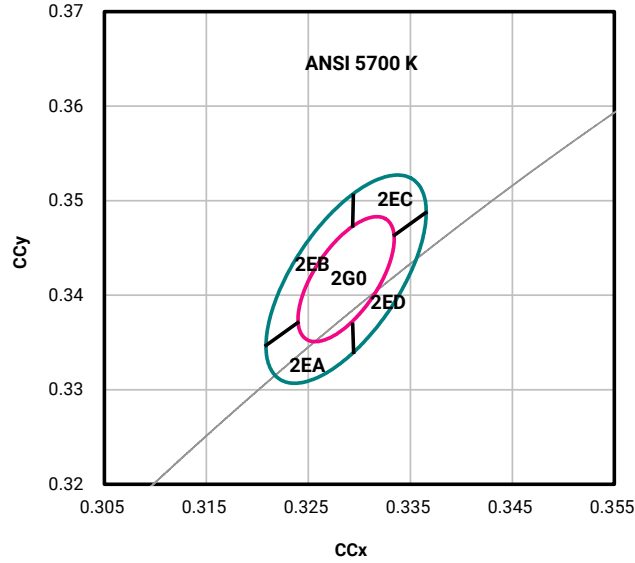

CCT	MacAdam Ellipse	Included Bins	Center Point		Major Axis	Minor Axis	Rotation Angle (°)
			x	y	a	b	
5700 K	3-step	2G0	0.3287	0.3417	0.00746	0.00320	59.09
	Kitted 3-step	2G0, 2EA, 2EB, 2EC, 2ED	0.3287	0.3417	0.01243	0.00533	59.09

PERFORMANCE GROUPS - CHROMATICITY - CONTINUED ($T_j = 85\text{ }^\circ\text{C}$)

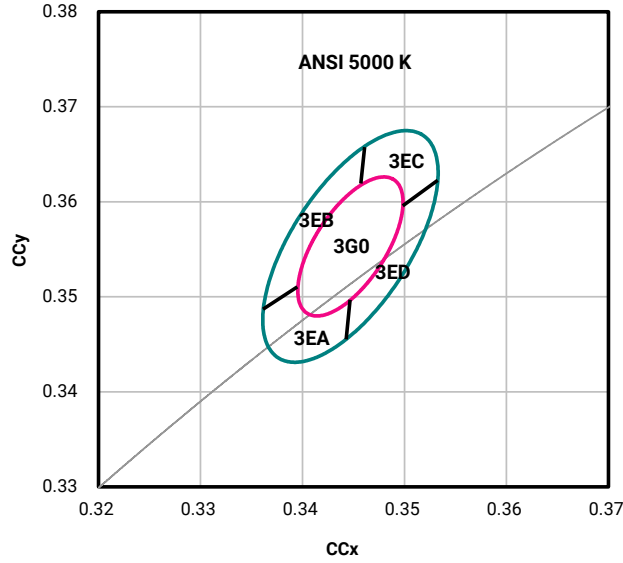

CCT	MacAdam Ellipse	Included Bins	Center Point		Major Axis	Minor Axis	Rotation Angle (°)
			x	y	a	b	
5000 K	3-step	3G0	0.3447	0.3553	0.00822	0.00354	59.62
	Kitted 3-step	3G0, 3EA, 3EB, 3EC, 3ED	0.3447	0.3553	0.01370	0.00590	59.62

PERFORMANCE GROUPS - CHROMATICITY - CONTINUED ($T_j = 85\text{ }^\circ\text{C}$)

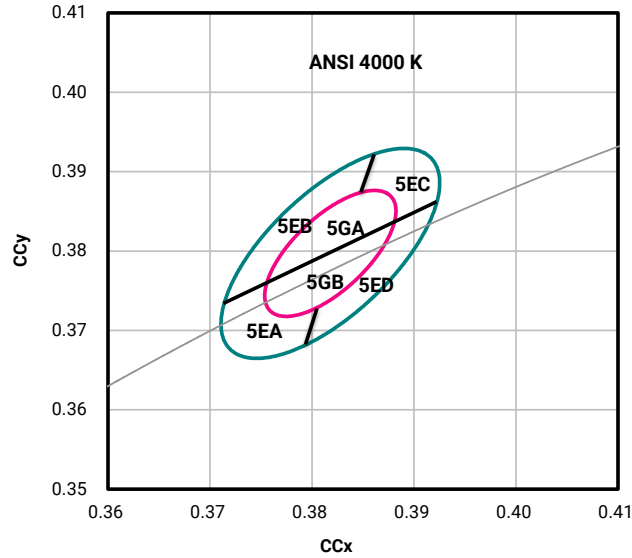

CCT	MacAdam Ellipse	Included Bins	Center Point		Major Axis	Minor Axis	Rotation Angle (°)
			x	y	a	b	
4000 K	3-step	5GA, 5GB	0.3818	0.3797	0.00939	0.00402	53.72
	Kitted 3-step	5GA, 5GB, 5EA, 5EB, 5EC, 5ED	0.3818	0.3797	0.01565	0.00670	53.72

PERFORMANCE GROUPS - CHROMATICITY - CONTINUED ($T_j = 85\text{ }^\circ\text{C}$)

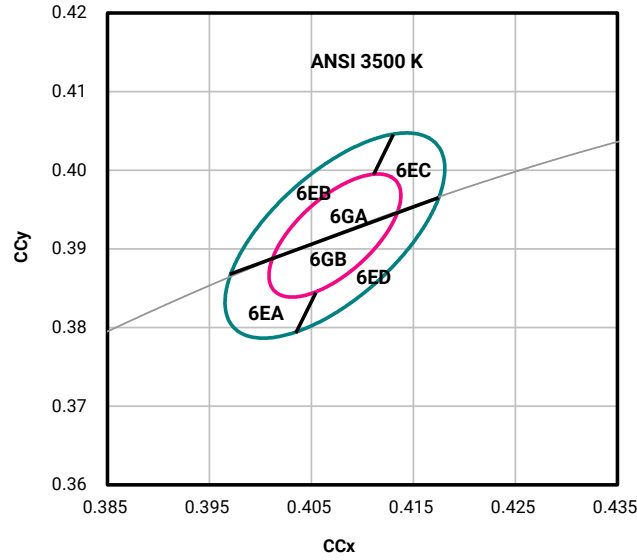

CCT	MacAdam Ellipse	Included Bins	Center Point		Major Axis	Minor Axis	Rotation Angle (°)
			x	y	a	b	
3500 K	3-step	6GA, 6GB	0.4073	0.3917	0.00927	0.00414	54.00
	Kitted 3-step	6GA, 6GB, 6EA, 6EB, 6EC, 6ED	0.4073	0.3917	0.01545	0.00690	54.00

PERFORMANCE GROUPS - CHROMATICITY - CONTINUED ($T_j = 85\text{ }^\circ\text{C}$)

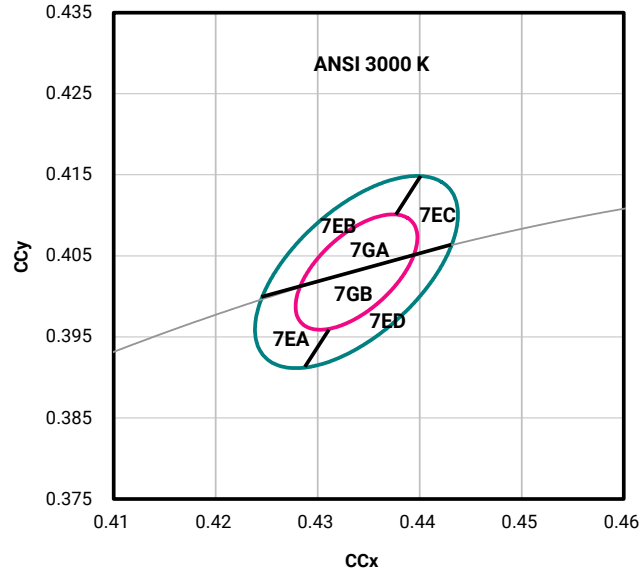

CCT	MacAdam Ellipse	Included Bins	Center Point		Major Axis	Minor Axis	Rotation Angle (°)
			x	y	a	b	
3000 K	3-step	7GA, 7GB	0.4338	0.4030	0.00834	0.00408	53.22
	Kitted 3-step	7GA, 7GB, 7EA, 7EB, 7EC, 7ED	0.4338	0.4030	0.01390	0.00680	53.22

PERFORMANCE GROUPS - CHROMATICITY - CONTINUED ($T_j = 85\text{ }^\circ\text{C}$)

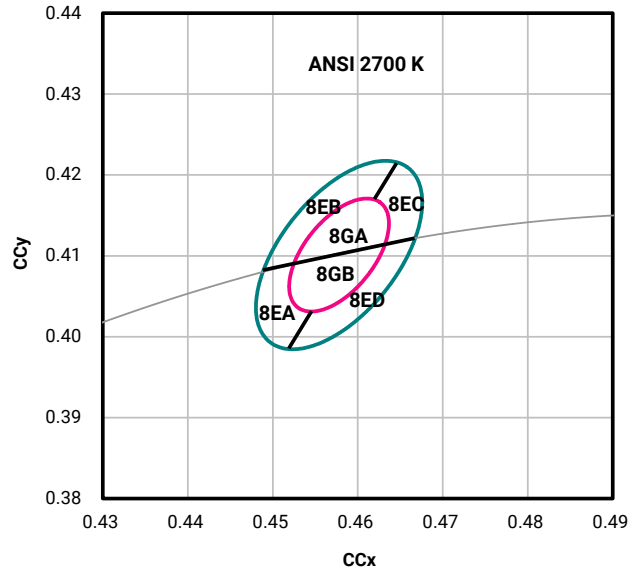

CCT	MacAdam Ellipse	Included Bins	Center Point		Major Axis	Minor Axis	Rotation Angle (°)
			x	y	a	b	
2700 K	3-step	8GA, 8GB	0.4578	0.4101	0.00810	0.00420	53.70
	Kitted 3-step	8GA, 8GB, 8EA, 8EB, 8EC, 8ED	0.4578	0.4101	0.01350	0.00700	53.70

PERFORMANCE GROUPS - CHROMATICITY - CONTINUED ($T_j = 85\text{ }^\circ\text{C}$)

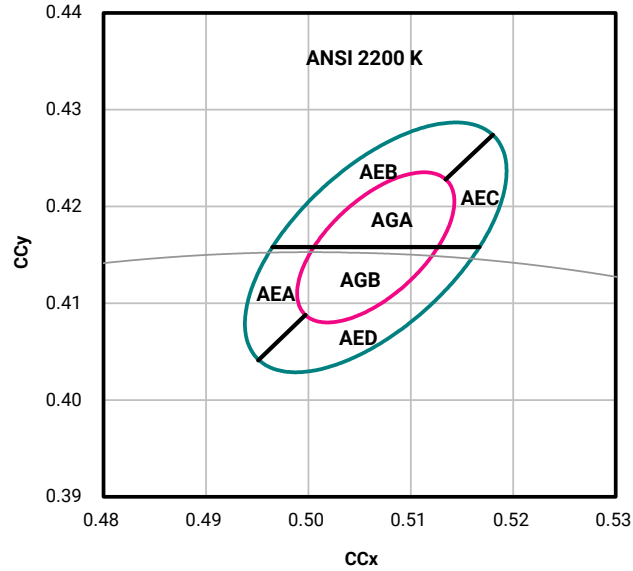

CCT	MacAdam Ellipse	Included Bins	Center Point		Major Axis	Minor Axis	Rotation Angle (°)
			x	y	a	b	
2200 K	3-step	AGA, AGB	0.5066	0.4158	0.0098	0.0048	45.5
	Kitted 3-step	AGA, AGB, AEA, AEB, AEC, AED	0.5066	0.4158	0.0163	0.0080	45.5

REFLOW SOLDERING CHARACTERISTICS

In testing, Cree Venture has found J Series 5050 LEDs to be compatible with JEDEC J-STD-020C, using the parameters listed below. As a general guideline, Cree Venture recommends that users follow the recommended soldering profile provided by the manufacturer of the solder paste used, and therefore it is the lamp or luminaire manufacturer’s responsibility to determine applicable soldering requirement.

Note that this general guideline may not apply to all PCB designs and configurations of reflow soldering equipment.

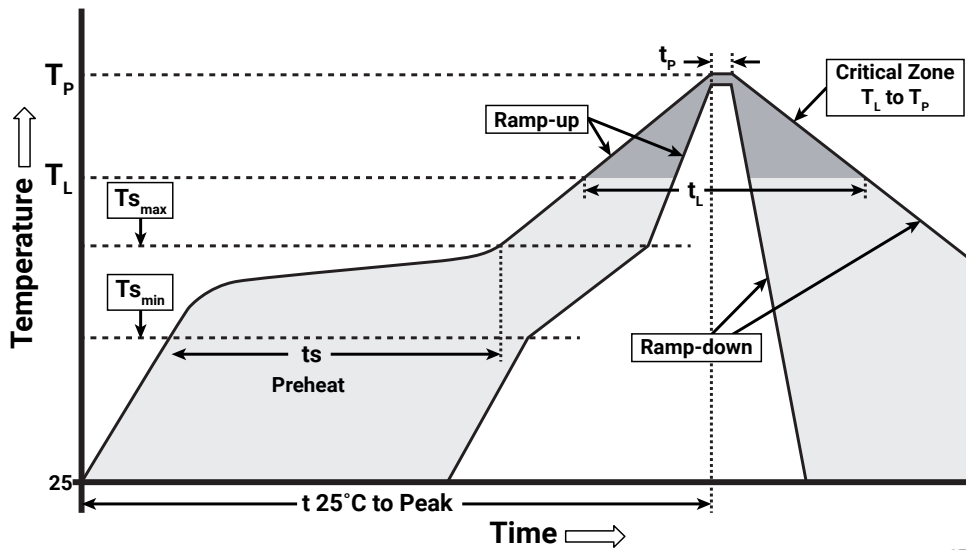

IPC/JEDEC J-STD-020C

Profile Feature	Lead-Free Solder
Average Ramp-Up Rate ($T_{s_{max}}$ to T_P)	1.2 °C/second
Preheat: Temperature Min ($T_{s_{min}}$)	120 °C
Preheat: Temperature Max ($T_{s_{max}}$)	170 °C
Preheat: Time ($t_{s_{min}}$ to $t_{s_{max}}$)	65-150 seconds
Time Maintained Above: Temperature (T_L)	217 °C
Time Maintained Above: Time (t_L)	45-90 seconds
Peak/Classification Temperature (T_P)	235 - 245 °C
Time Within 5 °C of Actual Peak Temperature (t_p)	20-40 seconds
Ramp-Down Rate	1 - 6 °C/second
Time 25 °C to Peak Temperature	4 minutes max.

Note: All temperatures refer to the topside of the package, measured on the package body surface.

NOTES

Measurements

The luminous flux, radiant power, chromaticity, forward voltage and CRI measurements in this document are binning specifications only and solely represent product measurements as of the date of shipment. These measurements will change over time based on a number of factors that are not within Cree Venture's control and are not intended or provided as operational specifications for the products. Calculated values are provided for informational purposes only and are not intended or provided as specifications.

Pre-Release Qualification Testing

Please read the [J Series Reliability Overview](#) for the details of the pre-release qualification testing for J Series LEDs

Lumen Maintenance

Cree Venture uses standardized IES LM-80-08 and TM-21-11 methods for collecting long-term data and extrapolating LED lumen maintenance. For information on the specific LM-80 data sets available for this LED, refer to the public [J Series LM-80 results document](#).

Please read the [Thermal Management application note](#) for details on how thermal design, ambient temperature, and drive current affect the LED junction temperature.

Moisture Sensitivity

Cree Venture recommends keeping J Series 5050 LEDs in the provided, resealable moisture-barrier packaging (MBP) until immediately prior to soldering. Unopened MBP that contains J Series 5050 LEDs does not need special storage for moisture sensitivity.

Once the MBP is opened, J Series 5050 LEDs should be handled and stored as MSL 3 per JEDEC J-STD-033, meaning they have limited exposure time before damage to the LED may occur during the soldering operation. The table on the right specifies the maximum exposure time in days depending on temperature and humidity conditions. LEDs with exposure time longer than the specified maximums must be baked according to the baking conditions listed below.

Moisture Sensitivity Level	Temp.	Maximum Percent Relative Humidity				
		50%	60%	70%	80%	90%
Level 3	35 °C	8	5	1	0.5	0.5
Level 3	30 °C	11	7	1	1	1
Level 3	25 °C	14	10	2	1	1
Level 3	20 °C	20	13	2	1	1

Baking Conditions

It is not necessary to bake all J Series 5050 LEDs. Only the LEDs that meet all of the following criteria must be baked:

1. LEDs that have been removed from the original MBP.
2. LEDs that have been exposed to a humid environment longer than listed in the Moisture Sensitivity section above.
3. LEDs that have not been soldered.

LEDs should be baked at 60 °C for 24 hours. LEDs may be baked in the original reels. Remove LEDs from the MBP before baking. Do not bake parts at temperatures higher than 60 °C. This baking operation resets the exposure time as defined in the Moisture Sensitivity section above.

NOTES - CONTINUED

RoHS Compliance

The levels of RoHS restricted materials in this product are below the maximum concentration values (also referred to as the threshold limits) permitted for such substances, or are used in an exempted application, in accordance with EU Directive 2011/65/EC (RoHS2), as implemented January 2, 2013. RoHS Declarations for this product can be obtained from your Cree Venture representative or from the [Product Ecology](#) section of the Cree LED website.

REACH Compliance

REACH substances of very high concern (SVHCs) information is available for this product. Since the European Chemical Agency (ECHA) has published notice of their intent to frequently revise the SVHC listing for the foreseeable future, please contact a Cree LED representative to insure you get the most up-to-date REACH SVHC Declaration. REACH banned substance information (REACH Article 67) is also available upon request.

UL® Recognized Component

This product meets the requirements to be considered a UL Recognized Component with Level 4 enclosure consideration. The LED package or a portion thereof has been investigated as a fire and electrical enclosure per ANSI/UL 8750.

Vision Advisory

WARNING: Do not look at an exposed lamp in operation. Eye injury can result. For more information about LEDs and eye safety, please refer to the [J Series LED Eye Safety application note](#).

MECHANICAL DIMENSIONS

Vias, if present, are not shown on these drawings.

The center thermal pad is electrically active and should not be connected to the anode or cathode.

All measurements are ±0.2 mm unless otherwise indicated.

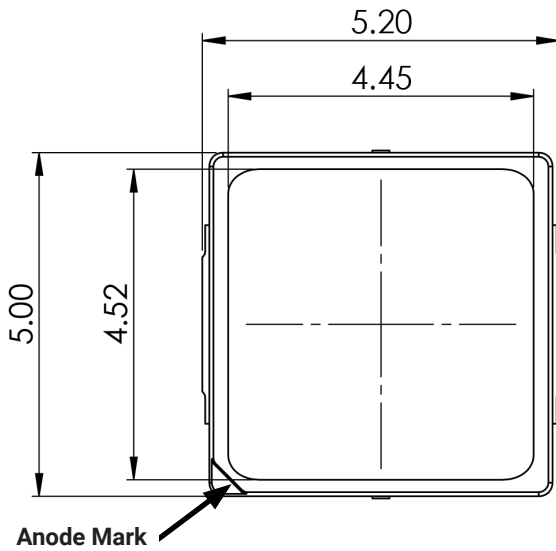

Top View

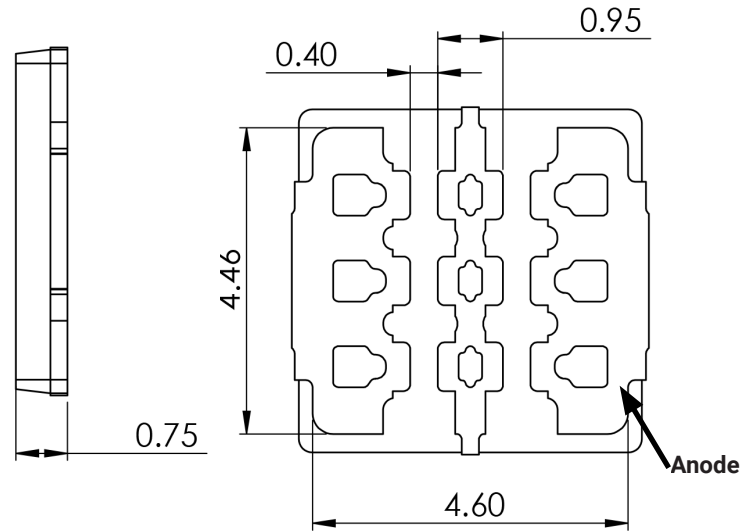

Side View

Bottom View

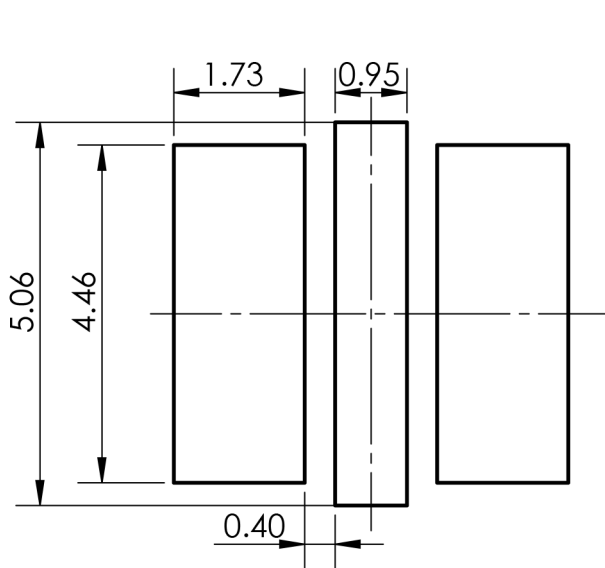

LED Solder Pad

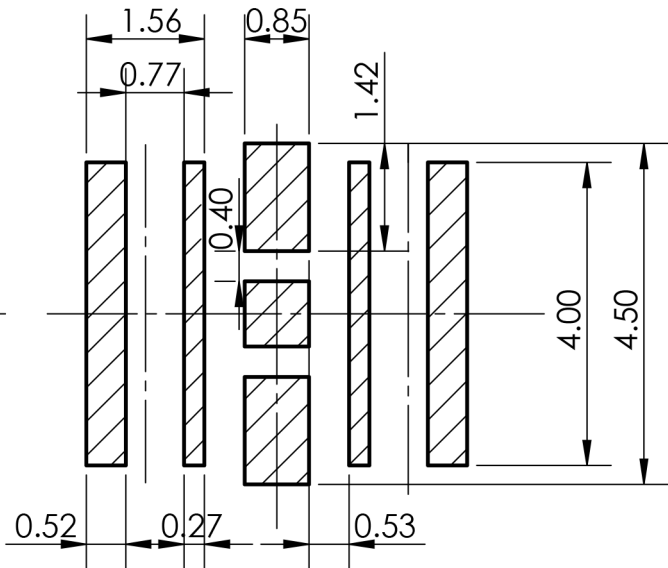

Recommended Stencil Pattern
(Shaded Area Is Open)

TAPE & REEL

All Cree Venture carrier tapes conform to EIA-481D, Automated Component Handling Systems Standard.

All dimensions in mm.

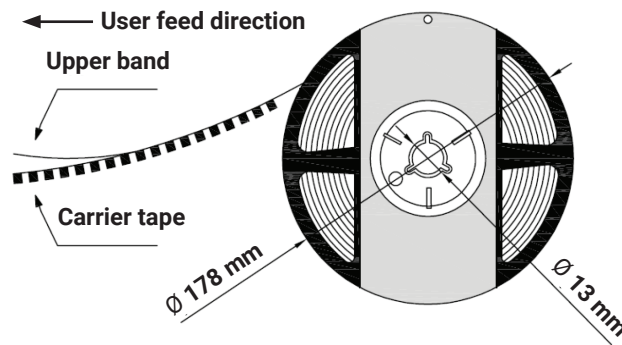
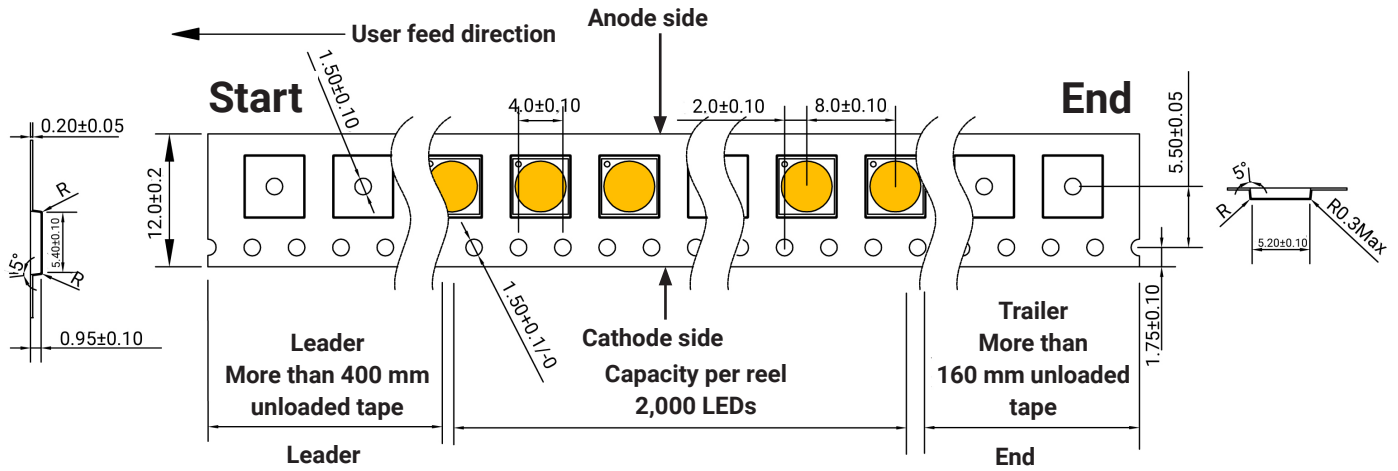

PACKAGING

Unpackaged Reel

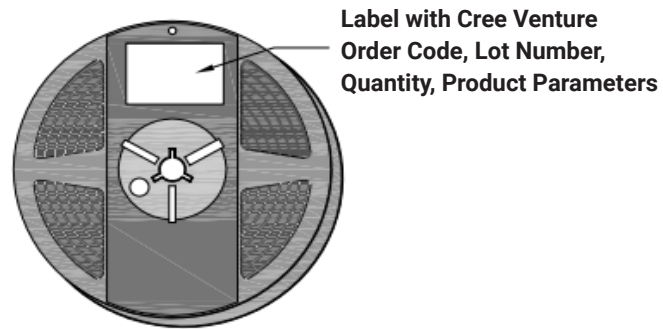

Packaged Reel

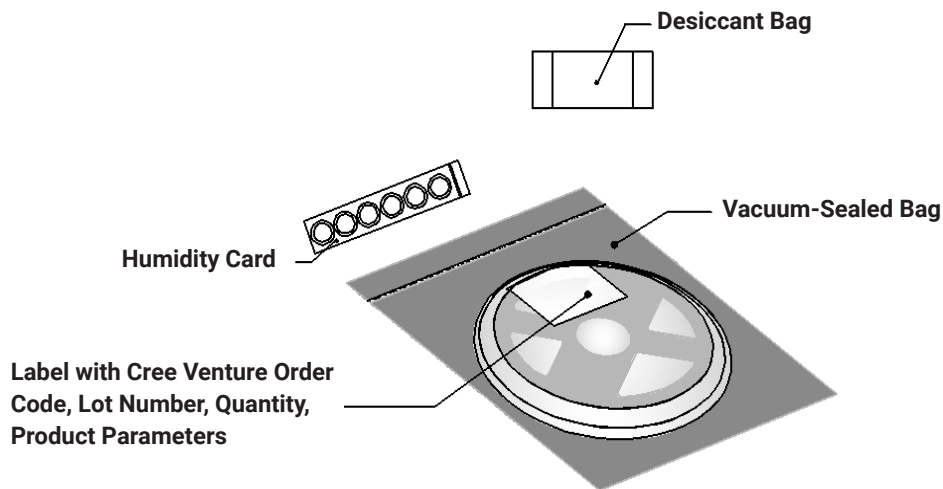

PACKAGING - CONTINUED

J Series 5050 LEDs are packaged in boxes for shipment. Box sizes and the number of reels per box are as follows.

Box	Box Dimensions	Maximum Number of Reels per Box
1	250 x 210 x 30 mm	2
2	250 x 210 x 50 mm	3
3	530 x 230 x 275 mm	32
4	530 x 443 x 275 mm	64

Each box has at least one label (shown as a white square in the diagrams below) showing the order code, lot number, quantity, and product parameters.

Box 1

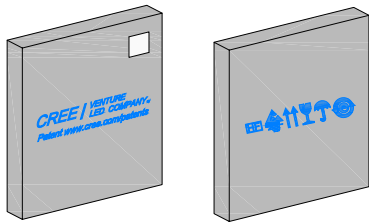

Box 2

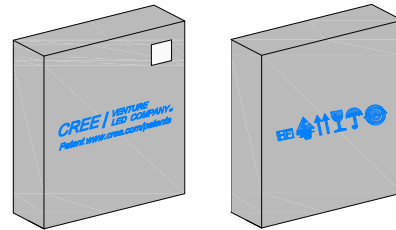

Box 3

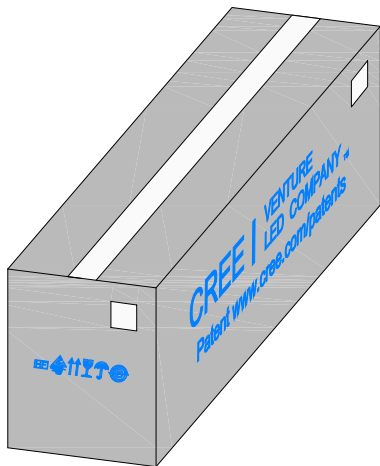

Box 4

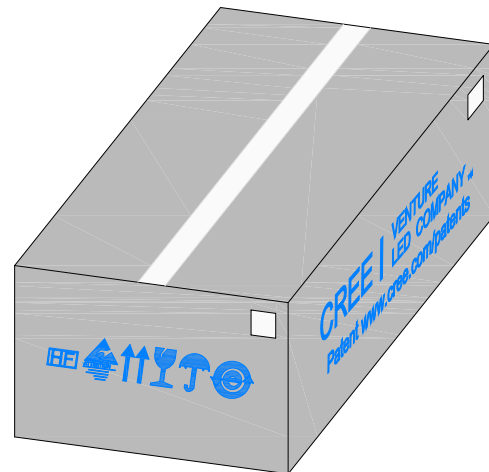

X-ON Electronics

Largest Supplier of Electrical and Electronic Components

Click to view similar products for Cree manufacturer:

Other Similar products are found below :

[C4SMA-BGF-CR2T3452](#) [C4SMA-BGF-CR34Q4S2](#) [C4SMA-BGY-CR2T3452](#) [C4SMA-BGY-CR34Q4S1](#) [C4SMA-GGF-CV14Q7C2](#)
[C4SMA-GGY-CU2W37A1](#) [C4SMA-RGF-CS4V1BB1](#) [C4SMA-RGF-CT34QBB2](#) [C4SMA-RGY-CS4V1BB1](#) [C4SMA-RGY-CT24QBB2](#)
[C4SMB-BGF-CT24Q3S2](#) [C4SMB-BGY-CT24Q4S1](#) [C4SMB-GGF-CX3Z4791](#) [C4SMB-GGF-CY14Q8S2](#) [C4SMB-RGF-CU4X1BB1](#)
[C4SMB-RGY-CV14QBB1](#) [C4SMG-BJS-CQ0T0451](#) [C4SMG-BJS-CQ14Q4T1](#) [C4SMH-RJS-CR0T0BB1](#) [C4SMK-GJS-CU34Q8T2](#) [C4SMM-](#)
[BJF-CP14Q3C1](#) [C4SMM-GJF-CT2V1791](#) [C4SMM-GJF-CT44Q7C1](#) [C4SMM-GJF-CT44Q7C2](#) [C4SMM-RJF-CS24QBB2](#) [C4SMN-GJF-](#)
[CW24Q7C2](#) [C503B-AAN-CA0B0341](#) [C503B-AAN-CA0C0252-015](#) [C503B-AAN-CA0C0341-015](#) [C503B-AAN-CA0C0342-015](#) [C503B-](#)
[AAN-CY0B0251](#) [C503B-AAN-CY0B0252](#) [C503B-AAN-CZ0B0342](#) [C503B-AAS-CA0B0341](#) [C503B-AAS-CA0C0251-015](#) [C503B-AAS-](#)
[CA0C0252-015](#) [C503B-AAS-CA0C0341-015](#) [C503B-AAS-CY0B0251](#) [C503B-AAS-CY0B0252](#) [C503B-AAS-CZ0B0342](#) [C503B-ABN-](#)
[CW0Z0251](#) [C503B-ABN-CW0Z0252](#) [C503B-ABN-CX0Y0341](#) [C503B-ABN-CX0Y0342](#) [C503B-ABN-CY0Z0341](#) [C503B-ABN-CY0Z0342](#)
[C503B-ABS-CW0Z0251](#) [C503B-ABS-CX0Y0342](#) [C503B-ACN-CX0Y0251](#) [C503B-ACN-CX0Y0341](#)