

SMT to SOIC-Wide Header (1.27mm Pitch, for 300 mil IC body)

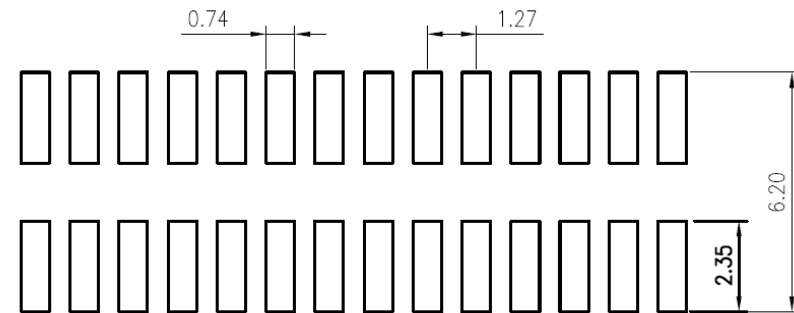

P.C.B. LAYOUT

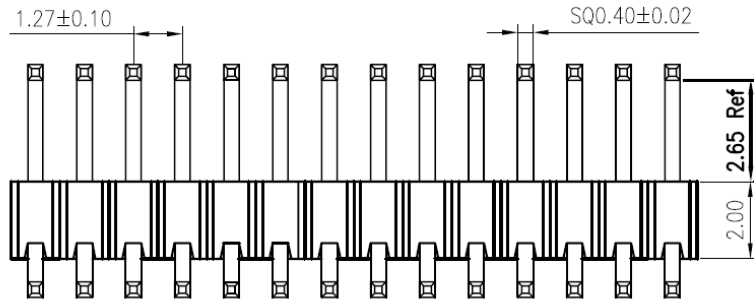
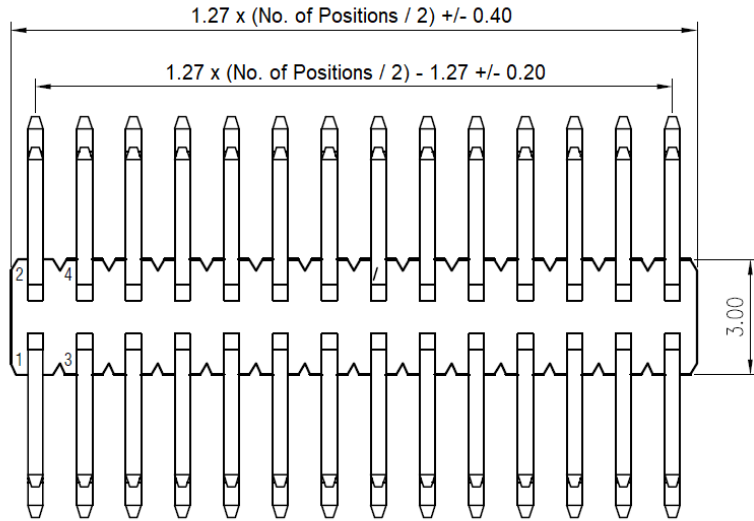
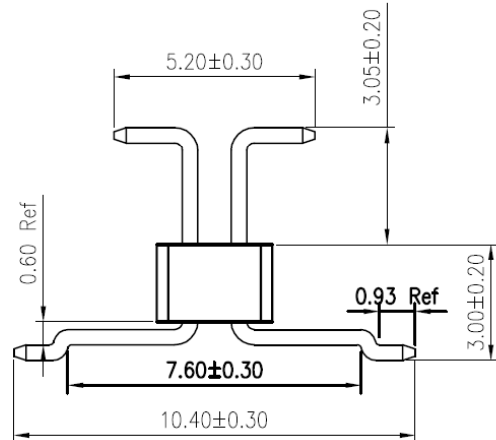

SPECIFICATIONS

Plastic body construction:	PA6T plastic (320°C melting point)
Pin construction:	Gold plated (brass pin, with 1um gold over 50um nickel)
Operating temperature range:	-40°C to +130°C
Reflow maximum temperature:	+260°C
Current rating:	1.0 Amp / contact
Contact resistance:	≤ 20 mΩ / contact
Insulation resistance:	≥ 500 MΩ (at V = 100V)
Withstanding voltage:	300 V AC / minute

AVAILABLE PART NUMBERS

Orderable Part Number	Total Pin Count	Pin Arrangement
HDR-SOICW-08	8	2x4
HDR-SOICW-10	10	2x5
HDR-SOICW-12	12	2x6
HDR-SOICW-14	14	2x7
HDR-SOICW-16	16	2x8
HDR-SOICW-18	18	2x9
HDR-SOICW-20	20	2x10
HDR-SOICW-22	22	2x11
HDR-SOICW-24	24	2x12
HDR-SOICW-26	26	2x13
HDR-SOICW-28	28	2x14
HDR-SOICW-80	80	2x40

PART PHOTOS



HDR-SOICW-08

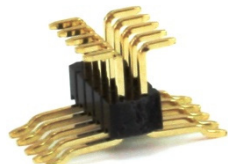

HDR-SOICW-10

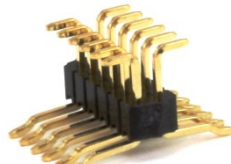

HDR-SOICW-12

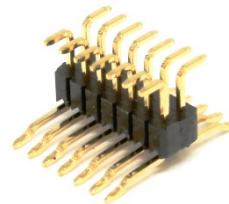

HDR-SOICW-14

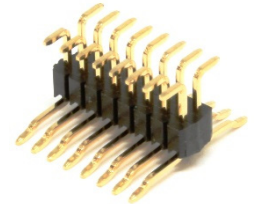

HDR-SOICW-16

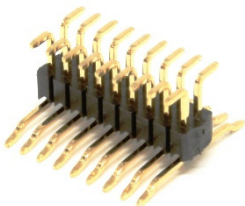

HDR-SOICW-18

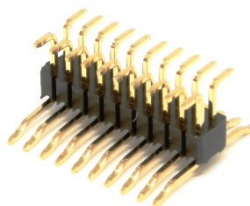

HDR-SOICW-20

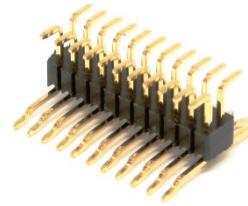

HDR-SOICW-22

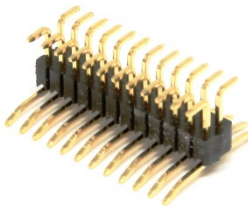

HDR-SOICW-24

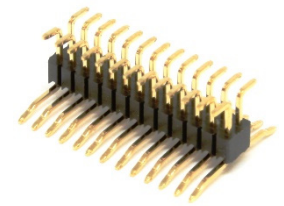

HDR-SOICW-26

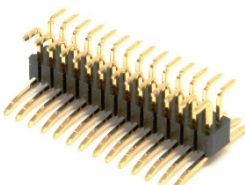

HDR-SOICW-28

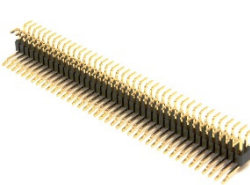

HDR-SOICW-80

X-ON Electronics

Largest Supplier of Electrical and Electronic Components

Click to view similar products for [Headers & Wire Housings](#) category:

Click to view products by [Chip Quik](#) manufacturer:

Other Similar products are found below :

[892-18-020-10-001101](#) [0010894062](#) [0010977306](#) [0015477636](#) [0015917161](#) [0022104068](#) [0022121042](#) [0022155065](#) [0022281023](#) [57102-F02-18ULF](#) [58102-G61-06LF](#) [582553-1](#) [0015911208](#) [01.001.5753.1](#) [0022285048](#) [0050291907](#) [02.125.8002.8](#) [CSU011177004](#) [622-0430](#) [622-3653LF](#) [63453-116](#) [636-1030](#) [636-1427](#) [636-3427](#) [636-4007](#) [641938-9](#) [65495-038](#) [65692-001LF](#) [65781-018](#) [65781-047](#) [65817-010LF](#) [65817-015LF](#) [67095-007LF](#) [67601157](#) [68631-112](#) [68645-018](#) [699319-000](#) [70.362.1628.0](#) [70-4210](#) [70-4226B](#) [70-4853B](#) [707-5028](#) [71.350.2428.0](#) [733-134](#) [733-162](#) [760-3052](#) [MHR-64-VUAL](#) [80.063.4001.1](#) [800-90-001-10-001000](#) [801-43-002-10-013000](#)