



A registered trademark of SNA Europe Group



GREEN CATALOGUE



INDEX

PRUNING ASSORTMENT	2
ICONOGRAPHY	3
BLADE TECHNOLOGY	4
ERGONOMIC CONCEPT	6
ONE-HAND SECATEURS	10
HARVESTING SNIPS	16
PNEUMATIC SECATEUR	18
LOPPERS	20
PRUNING SAWS	26
TOP PRUNERS AND POLES	34
BOWSAWS	36
HEDGE SHEARS	38
GRASS SHEARS	41
KNIVES	44
SCISSORS	45
BORDER AND SMALL GARDEN TOOLS	46
AXES, MAULS AND WEDGES	48
FILES	54
MAINTENANCE AND ACCESSORIES (GRINDING STONES, CLEANERS AND LUBRICANT, HOLSTERS, GLOVES, LANYARDS)	56
HAND TOOLS	62
TOOL STORAGE	67
HYDRAULIC AND LIFTING EQUIPMENT	68
ALPHANUMERICAL INDEX BY PRODUCT CODE	74

AN EXTENSIVE RANGE OF PRUNING TOOLS TO SATISFY THE DEMANDS OF PROFESSIONAL USERS AND DISCERNING GARDENERS

We listen to people who use our tools! Generally speaking these people are concerned with the management of plants. For these users, increased productivity and high quality results are the main features as they reduce fatigue and injuries, meanwhile providing durable performance.

What is more, in recent years, the new generation entering the business is having an increased interest in the design and aesthetics of the tools, whereas functional design used to be an important feature.

In response to customer feedback we have developed a well structured range that satisfies the demands of our end-users whilst maintaining the highest quality and performance of our tools.

The pruning assortment is available in two ranges:

A PROFESSIONAL RANGE WITH SPAREPARTS



A RANGE WITHOUT SPAREPARTS



We are recognized for our expertise in designing professional pruning tools. We are continuously looking for innovative solutions and technical improvements in order to make working life easier. To ensure that our end-users get the expected Bahco quality, our tools are protected by patents.

ICONOGRAPHY

To assist users in selecting the tools which best fit their needs, the assortment has been organized into:

AREAS OF APPLICATION

▶ VITICULTURE ▶ POMOLOGY ▶ LANDSCAPE ▶ FORESTRY ▶ GARDEN ▶ OUTDOOR



TYPES OF VEGETATION

▶ BRANCH MATURE AND DRY WOOD ▶ BRANCH LIVE AND GREEN WOOD ▶ SHRUBS ▶ HEDGES ▶ FLOWERS

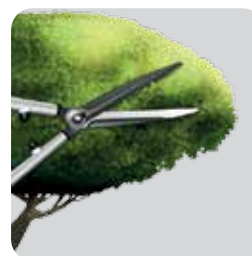

TABLE HEADERS

Product code	EAN code	Package quantity	Cutting capacity	Tool weight	Tool length	Handle size	Battery capacity	Working pressure	Air consumption	Blade length	Blade length
Toothing	Tooth per inch	Handle length	File length	File diameter	Round	Double edge	Flat with 2 straight edges	Flat with 2 round edges	Blade length	Blade length	



Left-handed

BLADE TECHNOLOGY

► **BYPASS:** for cutting live and green wood

Bypass secateurs and loppers are used for cuts that affect the health of the plant. The bypass cutting head owes its name to the fact that the cutting blade “passes-by” the counterblade in a scissor action. Bahco bypass secateurs slice through the wood as they cut it. This motion requires less force than a straight cut, and causes less compression damage to the wood.

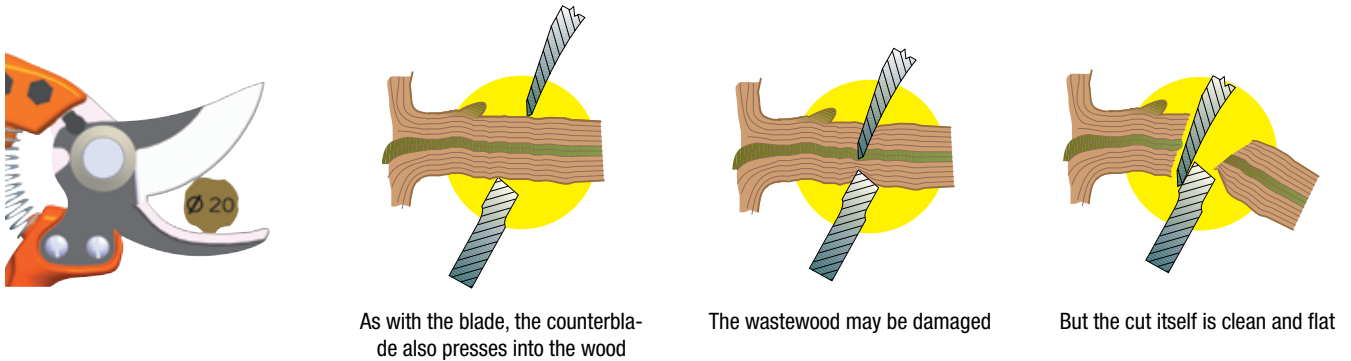

► **ANVIL:** for cutting mature and dry wood

Anvil secateurs and loppers are used where cleanliness of cut is not as important as removal. The blade is narrower and sharper than that of the bypass secateur. When cutting mature and dry wood, the blade must be forced through the wood with greater pressure. The “anvil” supports the branch and spreads the pressure to reduce damage.

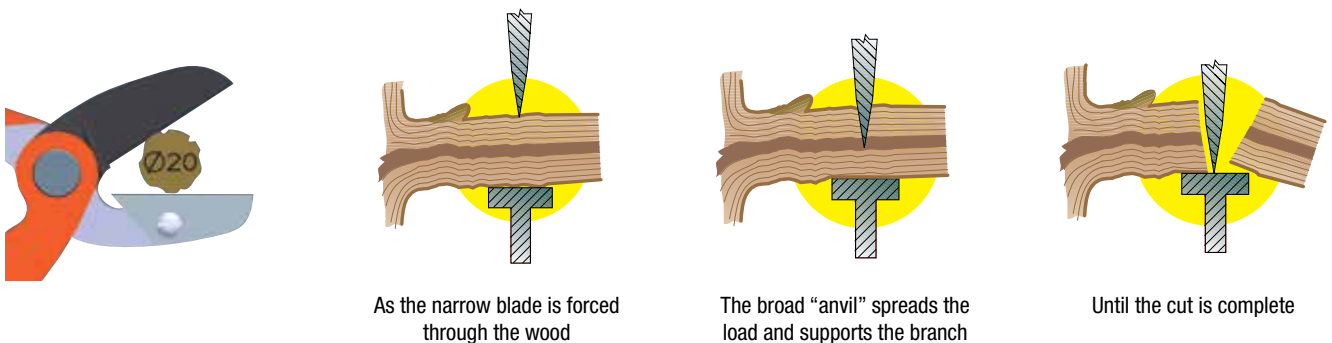

BYPASS



ANVIL



▶ THE CUTTING EDGE

▶ Four separate grinding operations are performed (Drawing A)

- 1- Main bevel, the cutting area of the blade is tapered to a point
- 2- Cavity, a shallow hollow is ground into the inner face of the blade
- 3- Second bevel, the edge is polished to a razor sharp point
- 4- Back bevel, an additional honing angle is ground on the inside edge

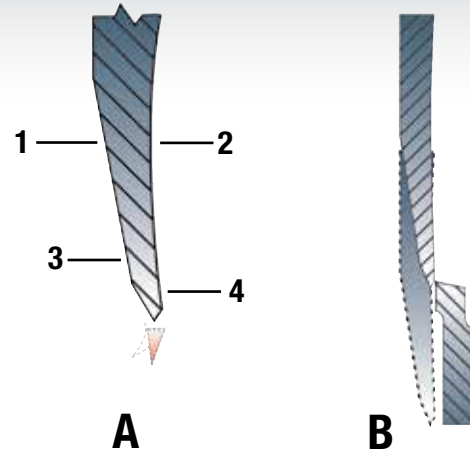

▶ Reduced friction and sticking (Drawing B)

Due to the hollow inner face, the blade only touches the counterblade at the point of cutting. This reduces friction and the risk of sticking and increases the performance of the tool.

▶ SLICING CUT

How it works

- ▶ The sharp upward curve of the blade causes the leading edge to “slice” as it cuts into wood.
- ▶ The off-centered pivot bolt doubles this slicing motion increasing the length of the blade which is used for cutting.



Why it works

- ▶ Imagine cutting a loaf of bread. No matter how sharp the blade, if you attempt to cut without slicing, the bread compresses and becomes harder to cut, therefore requiring more pressure which damages the loaf beyond repair. Bread and live wood are similar in that they can both be cut more efficiently if a slicing motion is added to the downward pressure.

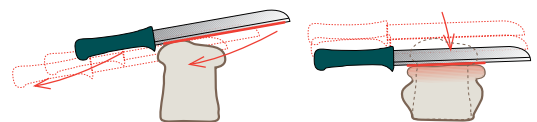

Results

- ▶ Less cutting force required
- ▶ Clean cut without damaging the plants
- ▶ Less wear and longer blade life
- ▶ Fewer broken blades



▶ EVOLVING BEVEL

- ▶ The evolving bevel technology is the latest improvement of the slicing cut. A unique grinding profile of the blade reinforces the slicing motion and facilitates the penetration into the wood, especially at the beginning of the cut. This gives the user a feeling of ease, quickness and efficiency during pruning activities.

The evolving bevel technology is exclusive to Bahco Pradines and utilized in the P116-SL lopper range.

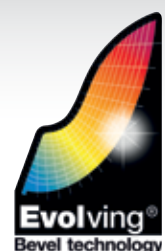

▶ **THE ERGONOMIC SECATEURS IMPROVES YOUR:**

- ▶ *Comfort* ▶ *Security* ▶ *Health* ▶ *Efficiency*

The design of the ergonomic secateurs results from five years of scientific research and hundreds of user tests all over the world. The benefit of the design of the ergonomic secateurs has two major advantages for the end-users: less fatigue at the end of the day and a less painful, longer and more productive working life.

▶ **WHAT MAKES THE PX AND PXR ERGONOMIC?**

FEATURES

- ▶ Vertical and lateral inclinations
- ▶ Shape of the handles
- ▶ Elastomer coating on upper handles
- ▶ Choice of cutting head
- ▶ Choice of spring
- ▶ Hand measuring system

BENEFITS

- ▶ Keeps your wrist in a neutral position
- ▶ Provides comfort
- ▶ Helps to spread pressure evenly
- ▶ Provides the right cutting head for each job
- ▶ Adapts the secateur to the power of your hand
- ▶ Guides you to find the best secateur for you

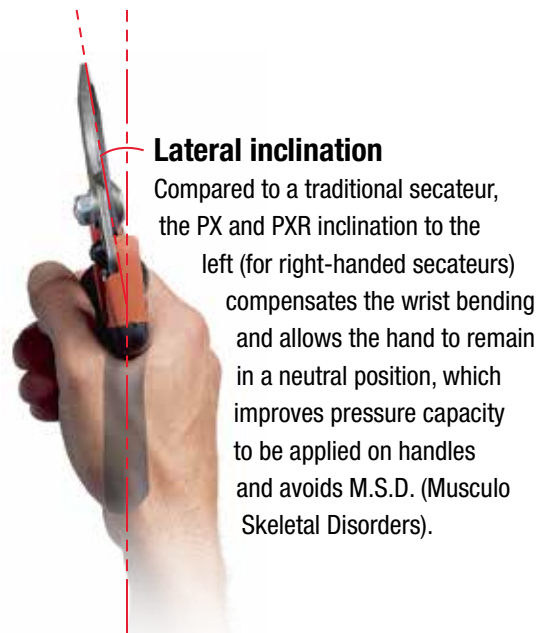

▶ PX TYPE

Fixed handle ergonomic secateurs

The most innovative secateur design in the world. Ergonomic design in a modular system that enables you to build a secateur that fits perfectly into your hand



▶ PXR TYPE

Rotating handle ergonomic secateurs

Same head and palm handle as the PX, but with a comfortable, elastomer coated rotating handle. PXR feels like part of your hand and cuts with optimal accuracy and ease



100% MODULARITY

All spare parts available

Right-handed handles

- PX-S
Fixed handle
Small size
- PX-M
Fixed handle
Medium size
- PX-L
Fixed handle
Large size
- PXR-S
Rotating handle
Small size
- PXR-M
Rotating handle
Medium size

N° 1 Small cutting head
(Cut. cap. 15 mm - 5/8")



Ø 15 mm (5/8")

N° 2 Medium cutting head
(Cut. cap. 20 mm - 3/4")



Ø 20 mm (3/4")

N° 3 Large cutting head
(Cut. cap. 30 mm - 1 1/4")



Ø 30 mm (1 1/4")

Cutting head sizes

Ideal for clearing vines from the trellis system, for young grapevines and for leaf pruning.
ERGO™ tip: highly recommended for users who are already suffering from aches and pains in their hand or arm.

Ideal for most common training methods in vineyards of up to 10 years of age.
ERGO™ tip: recommended for users who do not feel any pain yet, but who wish to avoid it.

Ideal for most common training methods in mature vineyards with strong canes.
ERGO™ tip: not recommended for users who already suffer from pains in the hand or arm. It is then advisable to use a lopper or a pruning saw when cutting large diameters.

Left-handed handles

- PX-M2-L
Fixed handle
Medium size for left handle
- PXR-M2-L
Rotating handle
Medium size for left handle

Cutting head size

N°2 Medium cutting head
(Cut. cap. 20 mm - 3/4")

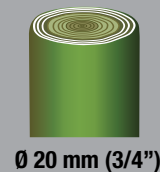

Ø 20 mm (3/4")



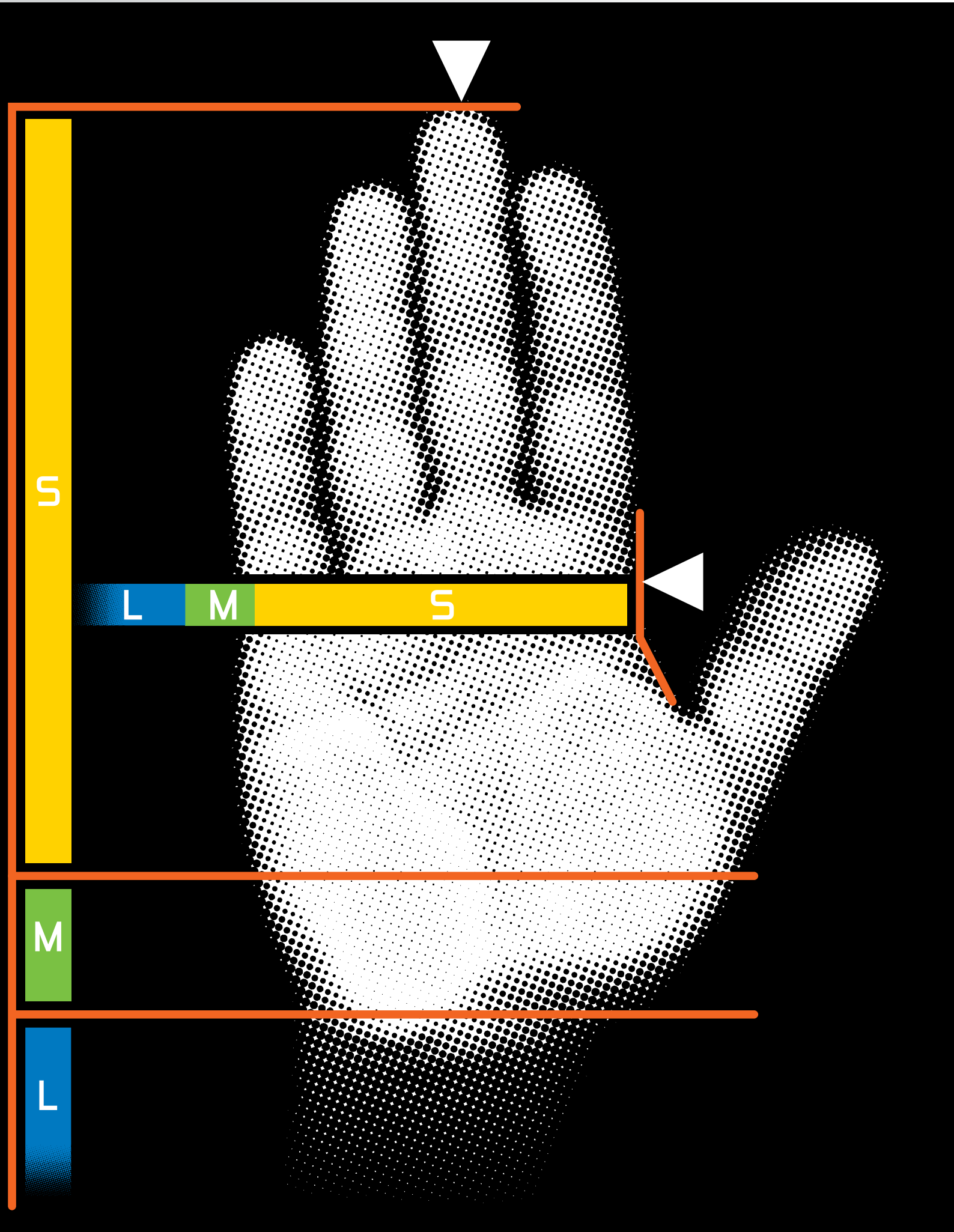

1

Measure hand from top of pointer finger to base of palm to determine the width of the hand

2

Measure finger tip to wrist to determine the length of the hand

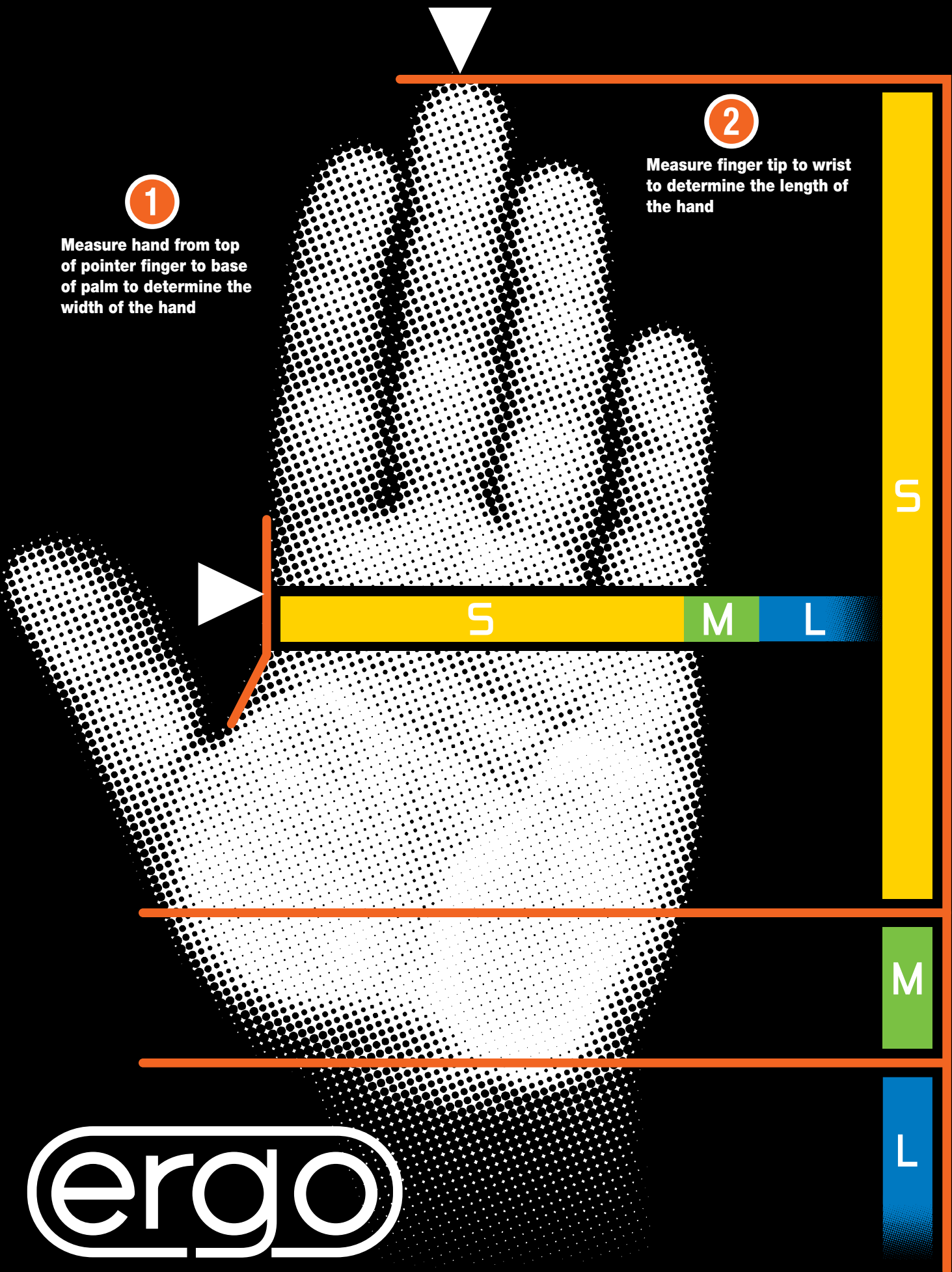

▶ ONE-HAND SECATEURS



▶ PX & PXR **ergo**[®]



- ▶ Size of the cutting head selected to the task to be performed
- ▶ Shape and size of handles selected to the size of the hand
- ▶ Fixed handle made of composite material with soft rubber on upper part
- ▶ All spare parts available



	INCH			mm.	inch	
PX-S1	8233785	2	S	15	1/2	308
PX-S2	8233792	2	S	20	3/4	296
PX-M1	8233815	2	M	15	1/2	322
PX-M2	8233822	2	M	20	3/4	319
PX-M2-L	8240714	2	M	20	3/4	319
PX-M3	8233839	2	M	30	1 1/4	347
PX-L2	8233853	2	L	20	3/4	331
PX-L3	8233860	2	L	30	1 1/4	470



- ▶ Size of the cutting head selected to the task to be performed
- ▶ Shape and size of handles selected to the size of the hand
- ▶ Comfortable elastomer coated rotating handle
- ▶ All spare parts available



	INCH			mm.	inch	
PXR-S1	8240677	2	S	15	1/2	366
PXR-S2	8240684	2	S	20	3/4	377
PXR-M1	8233877	2	M	15	1/2	382
PXR-M2	8233884	2	M	20	3/4	394
PXR-M2-L	8240738	2	M	20	3/4	394
PXR-M3	8233891	2	M	30	1 1/4	407
PXR-L2	8233914	2	L	20	3/4	395



▶ P1



- ▶ Designed for pruning vineyards, orchards and ornamental plants
- ▶ Blades with slicing cut and precision grinding for high performance
- ▶ Handles made of composite material in a comfortable shape
- ▶ Push-button locking device
- ▶ Spare parts available



	INCH			mm.	inch	mm.	inch	
P1-20	8044572	5	20	3/4	200	8	225	
P1-23	8332501	5	30	1 1/4	230	9	255	

▶ P3



- ▶ Larger cutting head for general pruning
- ▶ Very robust design with forged handles
- ▶ Spare parts available



	INCH			mm.	inch	mm.	inch	
P3-20-F	8275259	2	20	3/4	200	8	375	
P3-23-F	8275266	2	25	1	230	9	440	

▶ P110



- ▶ Narrow cutting head for easy reach
- ▶ Stamped and pressed steel handles
- ▶ Spare parts available



	INCH			mm.	inch	mm.	inch	
P110-20-F	8275532	2	20	3/4	200	8	315	
P110-23-F	8275549	2	25	1	230	9	390	

▶ P5



- ▶ General purpose secateur with narrow counter blade giving easy access to the inner branches of dense plants
- ▶ Very robust with a forged frame covered with a bi-material sleeve
- ▶ Spare parts available



	INCH			mm.	inch	mm.	inch	
P5-20-F	8275273	2	20	3/4	210	8 1/4	307	
P5-23-F	8275280	2	25	1	230	9	366	

▶ P108



- ▶ Narrow cutting head for easy reach
- ▶ Handles made of strong composite material with a soft grip on the upper part for maximum comfort
- ▶ Spare parts available



	INCH			mm.	inch	mm.	inch	
P108-20-F	8275518	2	20	3/4	200	8	305	
P108-23-F	8275525	2	25	1	230	9	375	

► **PG & PG-R** **ergo**[®]



- Xylan[®] coated blade for rust protection, less friction and maintenance-free use
- Narrow cutting head for easy reach
- The horizontal and vertical angles of the cutting head follow the natural alignment of the hand and the forearm
- Ergonomic handles available in 3 sizes (S,M,L) and 1 rotating handle for comfort



	PG	PG-R	mm.	inch	mm.	inch	
--	----	------	-----	------	-----	------	--

PG-S1-F	8327743	2	S	15	5/8	175	6 7/8	160
PG-M2-F	8269715	2	M	20	3/4	200	7 7/8	182
PG-L2-F	8269746	2	L	20	3/4	210	8 1/4	185
PG-R-M2-F	8269722	2	M	20	3/4	205	8	264

► **P138**



- Anvil secateur for cutting mature and dry wood
- Stamped and double bevelled blade
- Spare parts available



	PG	mm.	inch	mm.	inch	
--	----	-----	------	-----	------	--

P138-22-F	8301279	6	20	3/4	220	8 1/2	275
-----------	---------	---	----	-----	-----	-------	-----

► **P121**



- Narrow cutting head for easy reach
- Robust and traditional design with stamped and pressed steel handles



	PG	mm.	inch	mm.	inch	
--	----	-----	------	-----	------	--

P121-18-F	8275662	6	15	1/2	180	7	225
P121-20-F	8275631	6	20	3/4	200	8	255
P121-23-F	8275648	6	25	1	230	9	330

► **P126**



- Traditional secateur with robust design for general purpose gardening
- Handles made of stamped and pressed steel



	PG	mm.	inch	mm.	inch	
--	----	-----	------	-----	------	--

P126-19-F	8275297	6	15	1/2	190	7 1/2	245
P126-22-F	8275303	6	20	3/4	220	8 1/2	310

► **PG-01-F / PG-03-L**



- PG-01-F for right-hand use and PG-03-L for left-hand use
- Choice of two openings widths: 12 and 20 mm
- Xylan[®] coated blade for rust protection, less friction and maintenance-free use
- Fibreglass reinforced plastic handles and one-hand locking mechanism



	PG	mm.	inch	mm.	inch	
--	----	-----	------	-----	------	--

PG-01-F	8329334	6	20	3/4	200	7 7/8	220
PG-03-L	8242855	6	20	3/4	200	7 7/8	220

► **P64**



- Light secateur with handles made of composite material for picking roses, especially designed for cut flower production
- A special device on the blade holds on to the stem once cut
- P64-20-BULK12: display of 12 pcs
- Spring and buffers available as spare parts



	PG	mm.	inch	mm.	inch	
--	----	-----	------	-----	------	--

P64-20	8288174	1	12	1/2	210	7 7/8	210
P64-20-BULK12	8288204	12	12	1/2	210	7 7/8	2520



► **PG-12**



- Narrow cutting head for cutting flowers, herbs and shrubs
- Lightweight composite handles



	PG	mm.	inch	mm.	inch	
--	----	-----	------	-----	------	--

PG-12-F	8328122	10	20	3/4	210	8 1/4	165
---------	---------	----	----	-----	-----	-------	-----

► SPARE PARTS FOR ONE-HAND SECATEURS







				
	R300P	8234034	1	PX & PXR n°1 Ø 15 mm - 1/2"
	R211P	8234027	1	PX & PXR n°2 Ø 20 mm - 3/4"
	R211P-BULK80	8252212	80	PX & PXR n°2 Ø 20 mm - 3/4"
	R500P	8234041	1	PX & PXR n°3 Ø 30 mm - 1 1/4"
	R600P	8240783	1	PXR-M2-L, PX-M2-L
	R112PG	8010058	1	P3-20-F
	R122PG	8010072	1	P3-23-F
	R114PG	8010065	1	P110-20-F
	R124PG	8010089	1	P110-23-F
	R223P	8237554	1	P138-22-F
R223P-BULK80	8240646	80	P138-22-F	
	R303P	8234157	1	PX & PXR n°3 Ø 30 mm - 1 1/4"
	R403P	8234164	1	PX & PXR n°1 Ø 15 mm - 1/2"
	R503P	8234171	1	PX & PXR n°2 Ø 20 mm - 3/4"
	R603P	8240790	1	PXR-M2-L, PX-M2-L
	R113PG	8044374	1	P110-20-F
	R123PG	8044381	1	P110-23-F
	R221P	8229412	1	P138-22-F
	R221P-BULK50	8240653	50	P138-22-F
	R900P	8234188	1	PX & PXR
	R142P	8010126	1	P3-20-F, P3-23-F, P110-20-F, P110-23-F
	R141P	8288235	1	P64-20
	R905P* (soft)	8234232	1	PX & PXR, P64-20
	R905P-BULK50* (soft)	8252250	50	PX & PXR, P64-20
	R906P* (medium)	8234249	1	PX & PXR
	R906P-BULK50* (medium)	8252267	50	PX & PXR
	R907P* (hard)	8234256	1	PX & PXR
	R1068	8044398	1	P3-20-F, P3-23-F, P110-20-F, P110-23-F
	R463P*	8223908	1	P3-20-F, P3-23-F, P110-20-F, P110-23-F
	R438P*	8229429	1	P138-22-F
	R438P-BULK50*	8240660	50	P138-22-F

* spring only (without buffer)

	R904P	8234225	1	PX & PXR
	R341P	8011529	1	P3-20-F, P3-23-F
	R474P	8011536	1	P110-20-F, P110-23-F
	R902P	8234201	1	PX & PXR, P64-20
	R903P	8234218	1	PX & PXR, P64-20
	R1269P-BULK50	8240820	50	PX & PXR, P64-20
	R901P	8234195	1	PX & PXR
	R801P	8234126	1	PX & PXR n°1 Ø 15 mm - 1/2"
	R802P	8234133	1	PX & PXR n°2 Ø 20 mm - 3/4"
	R803P	8234140	1	PX & PXR n°3 Ø 30 mm - 1 1/4"
	R804P	8240806	1	PX & PXR n°2 Ø 20 mm - 3/4"
	RT821P	8242237	1	PXR-S1, PXR-S2
	RT822P	8234102	1	PXR-M1, PXR-M2, PXR-M3
	RT823P	8234119	1	PXR-L2
	RT824P	8240776	1	PXR-M2-L
	R811P	8234058	1	PX-S1, PX-S2
	R812P	8234065	1	PX-M1, PX-M2, PX-M3
	R813P	8234072	1	PX-L2, PX-L3
	R815P	8240752	1	PX-M2-L



► FEATURES AND AREAS OF APPLICATION OF SECATEURS

Secateur Type	Description	Cutting head	Application environment						Cutting capacity					Spare parts
*** Highly Recommended ** Recommended * Acceptable									12 mm 1/2"	15 mm 1/2"	20 mm	25 mm	30 mm	

Professional Secateurs Ergo

PX-Ergo	PX-S (range)	Heavy-duty ergonomic secateur with fixed handle	✓		***	***	***													✓	✓				✓																						
	PX-M (range)																			✓				✓						✓												✓					
	PX-L (range)																																										✓				
PXR-Ergo	PXR-S (range)	Heavy-duty ergonomic secateur with rotating handle	✓		***	***	***																		✓																						
	PXR-M (range)																								✓				✓						✓												✓
	PXR-L (range)																																														

Professional Secateurs

P5	P5-20-F	Robust, heavy-duty secateur with bi-material sleeve	✓		**	*	***																		✓
	P5-23-F																								
P108	P108-20-F	Secateur with slim cutting head and soft grip on the upper part of the handle	✓		**	**	*																		✓
	P108-23-F																								
P3	P110-20-F	Robust, heavy-duty secateur with solid forged steel handles	✓		**	*	***																		✓
	P110-23-F																								
P110	P110-20-F	Traditional style secateur with slim cutting head and stamped steel handles	✓		**	***	**																		✓
	P110-23-F																								
P64	P64-20	Light secateur designed for cut flower production	✓																						✓
P138	P138-22-F	Anvil secateur designed for cutting mature and dry wood		✓	**	***	**																		✓

Garden Secateurs

PG-Ergo	PG-S1-F	Ergonomic secateurs for demanding gardeners	✓		*	*	*	***																	✓																								
	PG-M2-F																																															✓	
	PG-L2-F																																																✓
	PG-R-M2-F																																																✓
PG	PG-01-F	Modern designed secateur for all year gardening	✓		*	*	*	***																	✓																								
	PG-03-L																								✓																						✓		
PG-12	PG-12-F	Secateur designed for leisure gardening	✓					***																	✓																								
P121	P121-18-F	Traditional style secateur for all year gardening	✓		**	**	*	***																	✓																								
	P121-20-F																																														✓		
	P121-23-F																																															✓	
P126	P126-19-F	Traditional style secateur for leisure gardening	✓		*	*	*	***																	✓																								
	P126-22-F																																														✓		

▶ ASSORTMENT OF SECATEURS

Professional Secateurs - The only true ergonomic secateurs! **ergo**®

S PX-S2
PX-S1

M PX-M3
PX-M2
PX-M1

L PX-L3
PX-L2

S PXR-S2
PXR-S1

M PXR-M3
PXR-M2
PXR-M1

L PXR-L2

M PXR-M2-L
PX-M2-L

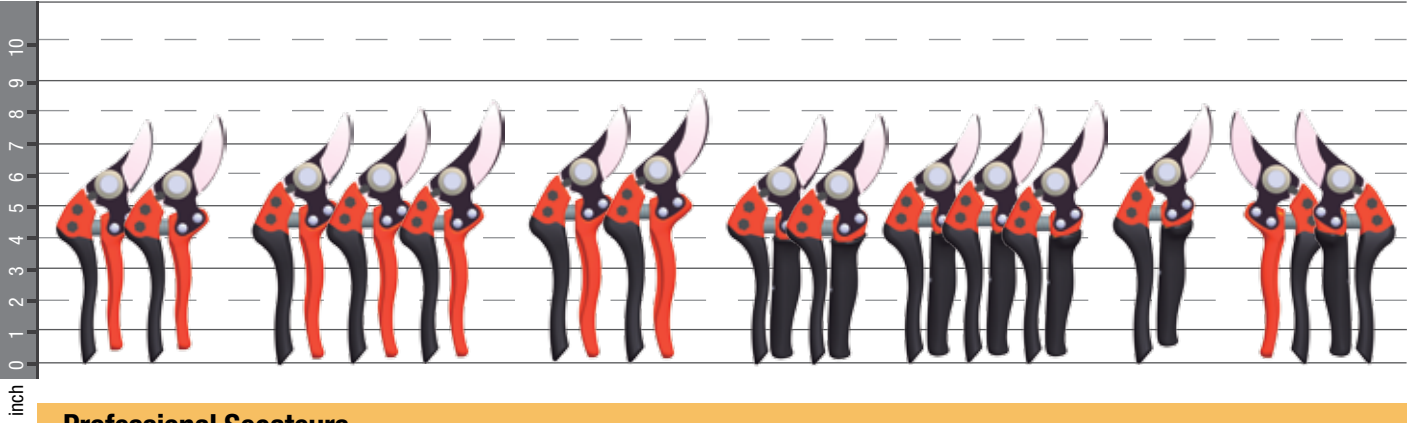

Professional Secateurs

L P5-23-F
M P5-20-F

L P108-23-F
M P108-20-F

L P3-23-F
M P3-20-F

L P110-23-F
M P110-20-F

L P1-23
M P1-20

L P138-22-F

M P64-20

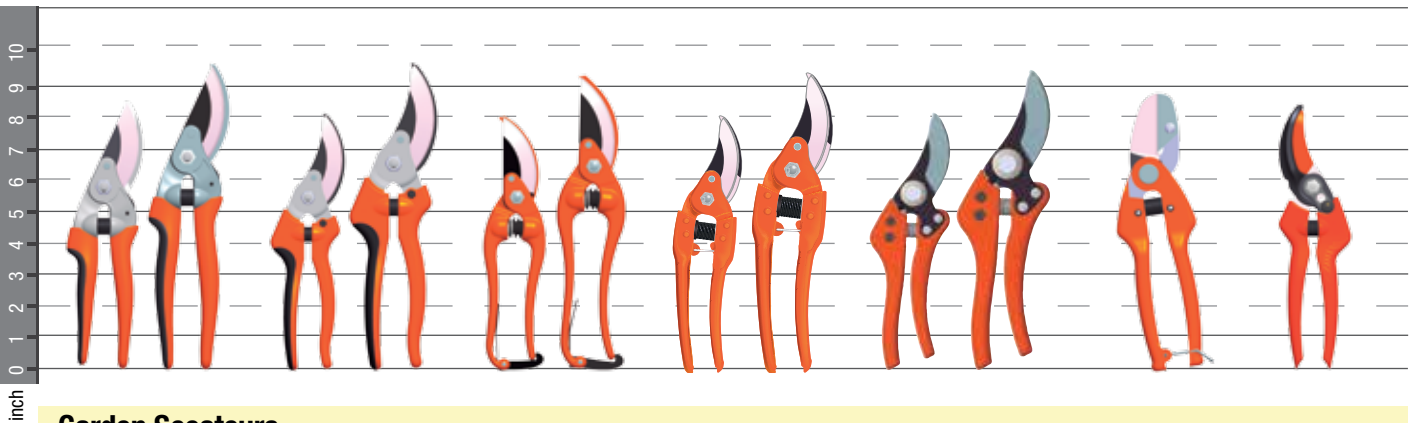

Garden Secateurs

L PG-L2-F
M PG-M2-F
S PG-S1-F
ergo®

M PG-R-M2-F
ergo®

M PG-03-L
M PG-01-F

M PG-12-F

L P121-23-F
M P121-20-F
S P121-18-F

L P126-22-F
S P126-19-F

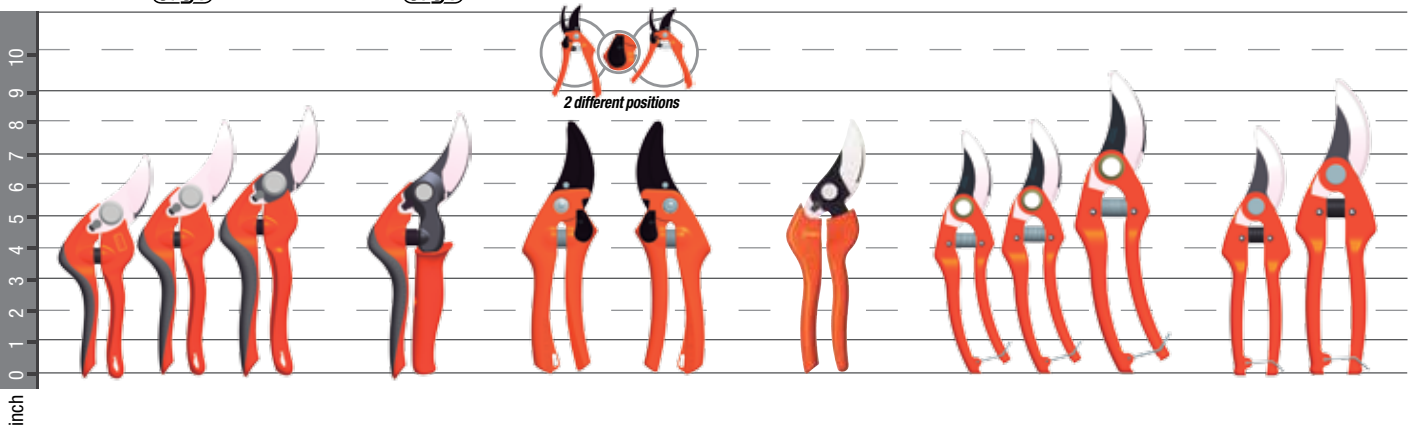

HARVESTING SNIPS

FOUR DIFFERENT CUTTING HEADS

The Bahco handy and light weight harvesting snips suit the needs of different end-users in their respective applications. They have comfortable handles made of fibreglass reinforced material. They are supplied with a light weight plastic holster and are available in different box quantities.

P123

Long and slim bypass cutting head

P127

Short blades, rounded at the tips for safety, with limited opening

P128

Long, slim and straight blades
Wide opening

P129

Same blades as P128 but bent at an 11° angle to give better access to hidden stems



Light weight plastic holster to avoid injuries and loss of the snip. Supplied with all snips models

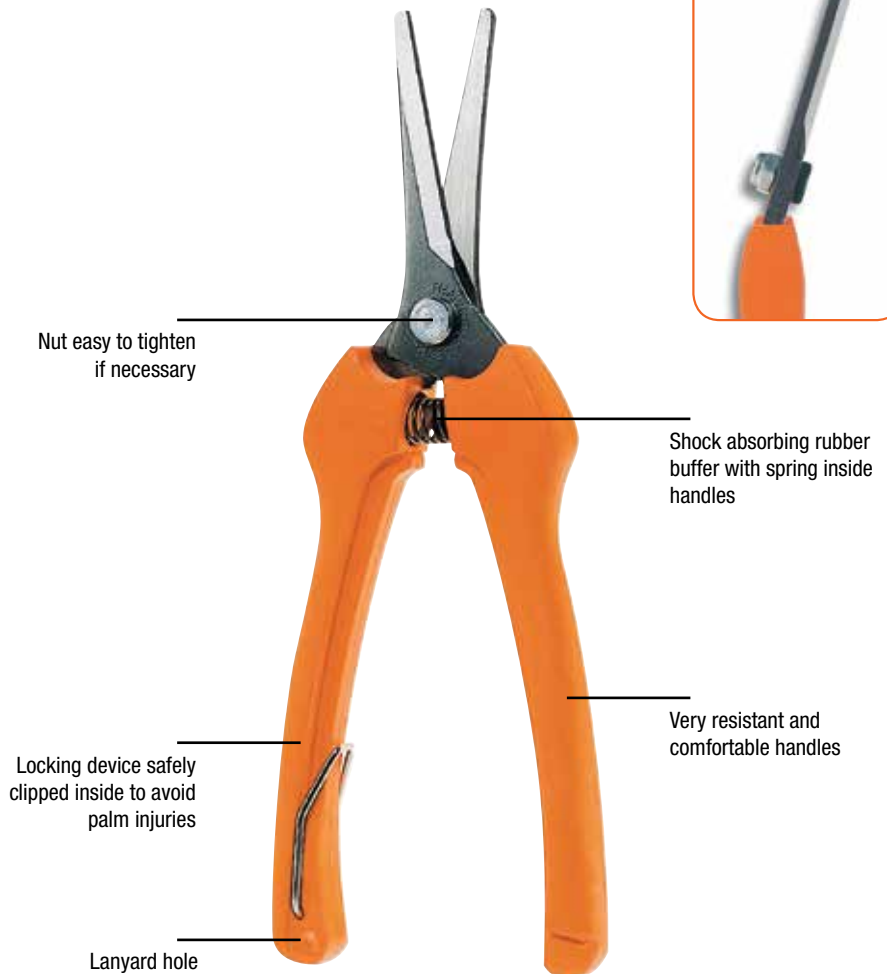



► **P123**



- Used for grape harvesting, soft stem fruit like cucumber, melon, tomato and flowers like tulips
- Long and fine bypass cutting head
- Snips in bulk 15 (P123-19-BULK15) and bulk 30 (P123-19-BULK30) are supplied with light weight plastic holster
- Snips in bulk 56 (P123-19-BULK56) are supplied without light weight plastic holster

		731151*		mm.	inch	mm.	inch	
P123-19-BULK15	8226251	15	10	3/8	190	7 1/2	87	
P123-19-BULK30	8218218	30	10	3/8	190	7 1/2	87	
P123-19-BULK56	8240202	56	10	3/8	190	7 1/2	87	

► **P127**



- Used for grape harvesting but also cuts thin wires
- Safety short and straight blades with rounded tips and a limited opening
- Notched counterblade to avoid slipping when cutting hard materials
- Supplied with light weight plastic holster, 30 pcs in a box

		731151*		mm.	inch	mm.	inch	
P127-19-BULK30	8199333	30	6	1/4	170	6 1/2	70	

► **P128**



- Recommended for thinning out the fruit to ensure a better growth (and bigger fruit size)
- Long, slim and straight blades
- Supplied with light weight plastic holster, 30 pcs in a box only valid for P128-19-BULK30; P128-19 supplied on card

		731151*		mm.	inch	mm.	inch	
P128-19	8160814	6	6	1/4	190	7 1/2	85	
P128-19-BULK30	8172329	30	6	1/4	190	7 1/2	85	

► **P129**



- Used for cutting fresh fruit stems and cleaning out fruit bunches
- Long and slim blades slightly bent (11°) to facilitate access to hidden stems
- Supplied with light weight plastic holster, 30 pcs in a box

		731151*		mm.	inch	mm.	inch	
P129-19-BULK30	8172336	30	6	1/4	190	7 1/2	85	

► **SPARE PARTS FOR HARVESTING SNIPS**

	R1071	8222918	1	P123-19
				P127-19
				P128-19
	R1075-BULK50	8220495	50	P123-19
				P127-19
				P129-19

PNEUMATIC SECATEUR

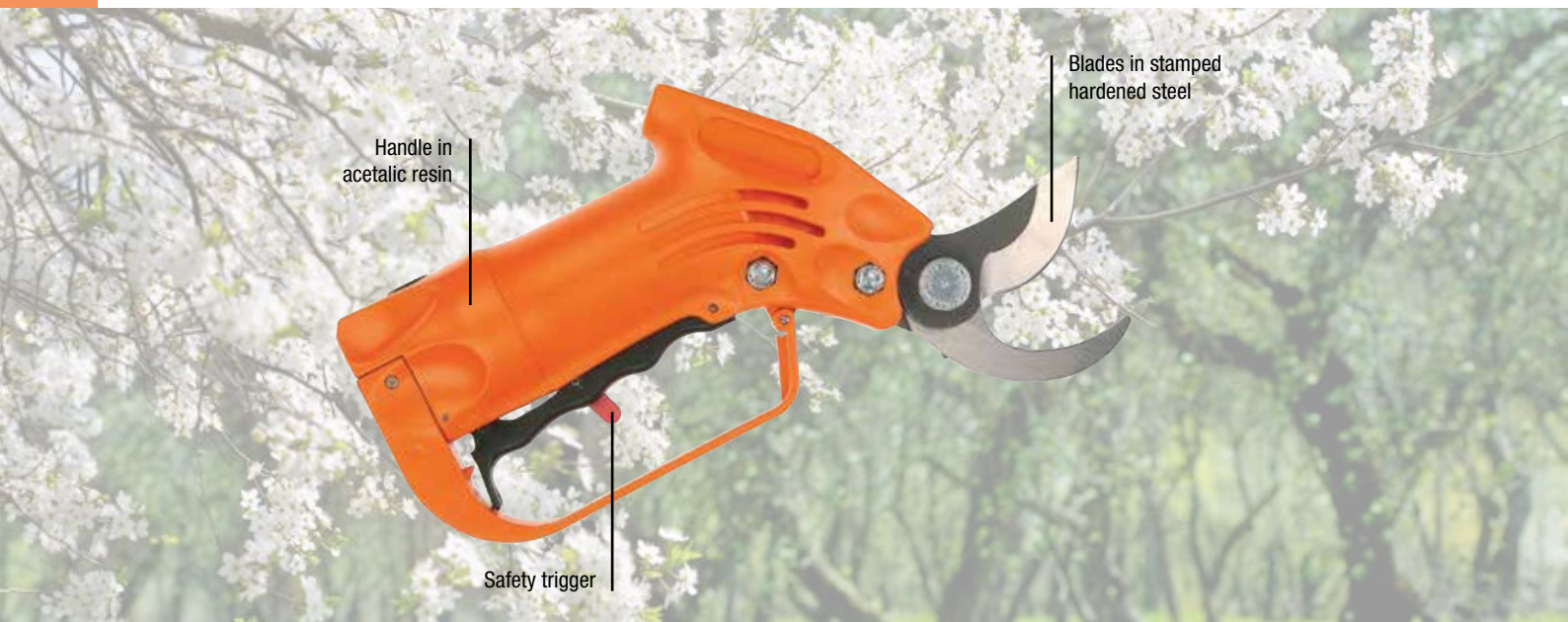

Handle in acetalic resin

Blades in stamped hardened steel

Safety trigger

▶ 9210



- ▶ Cutting head with excellent slicing cut
- ▶ Body made of acetalic resin (POM)
- ▶ Ergonomically designed handle in acetalic resin



- ▶ Blades in stamped hardened steel
- ▶ Centre-bolt locking system prevents loosening of the axis during continuous working
- ▶ Special ice-free valve protects the tool against condensation water freezing inside the tool in cold weather



- ▶ Single piston with a spring return
- ▶ Connecting thread requires a 1/4" male coupler for the air hose
- ▶ Never use above 10 bar air pressure



9210	8278182	1	30 mm.	1 1/4 inch	255 mm	10 inch	BAR	80 1/min	<10	700

The pneumatic secateur with a single cutting blade in hardened steel have been designed for pruning orchards, vineyards, citrus, olive trees, green and ornamental trees, etc.

A pneumatic piston inside a cylinder, with an outer body made of thermoplastic resin, creates the power of the cutting blade. The piston stroke action is driven by compressed air by means of a trigger in the handle. The safety hand guard protects the user from activating the tool accidentally. Whenever the trigger is released, an automatic safety catch, located on the trigger, will lock it.



► SPARE PARTS FOR PNEUMATIC SECATEUR

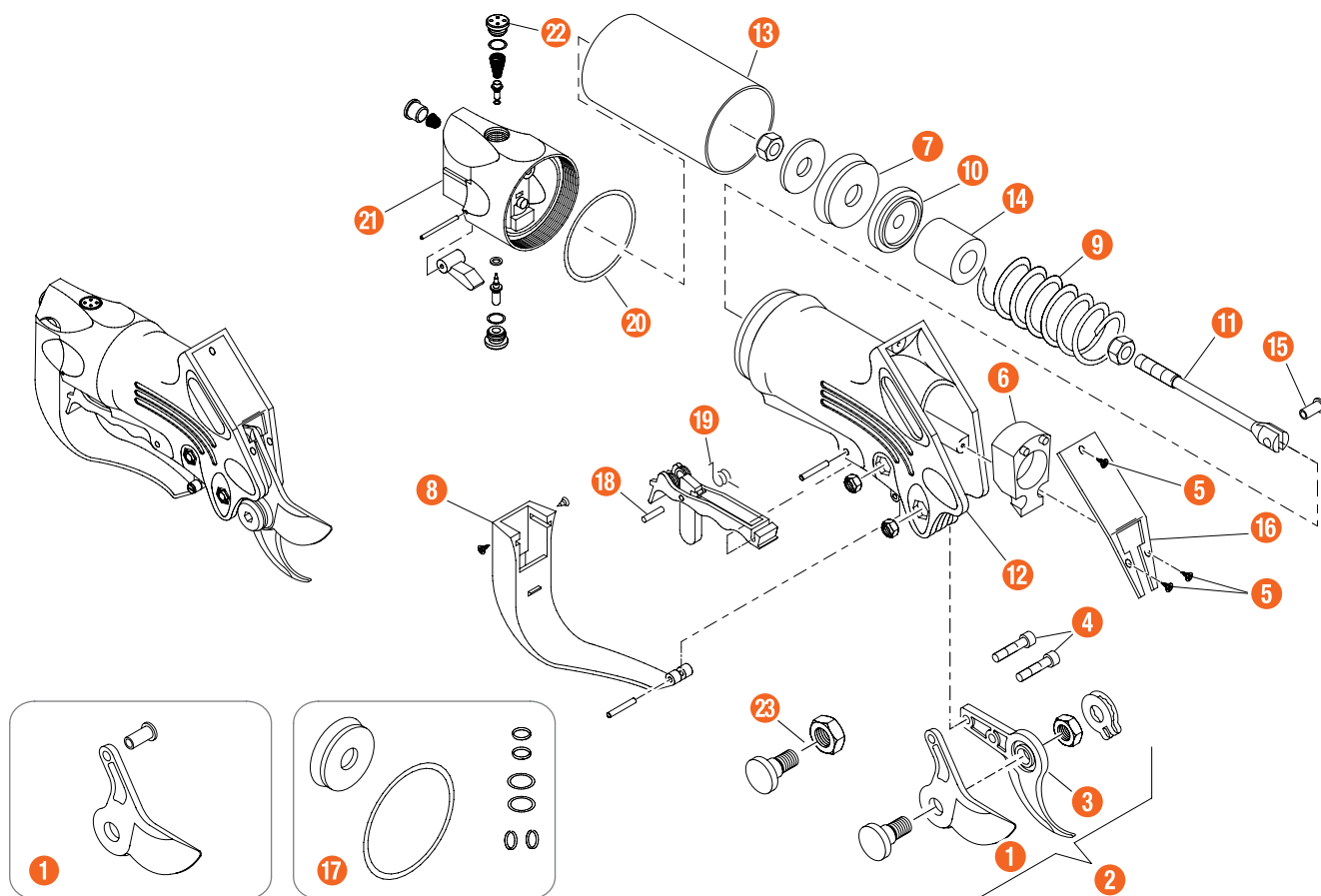

1	9210-1	Cutting blade + rivet	8278212	1
2	9210-10	Cutting head kit	8278229	1
3	9210-11	Counter blade	8296094	1
4	9210-1060177	Screw TCCE M6x20 UNI 5931	8295424	1
5	9210-1060238	Self-tapping screw TSP 2.2x6.5	8295394	20
6	9210-1230219	Dust protection seal	8295387	10
7	9210-1230235	Piston seal	8295325	10
8	9210-1320281	Hand guard	8295431	10
9	9210-1640142	Return spring	8295356	10
10	9210-1690148	Piston	8295332	1
11	9210-1700118	Connecting rod	8295363	1
12	9210-1710266	Secateur body	8295417	1
13	9210-1720100	Brass cylinder	8295295	10
14	9210-1730107	Shock absorber	8295349	10
15	9210-1770106	Rivet ø 6	8295370	40
16	9210-1830137	Front cover	8295400	10
17	9210-20	O-ring kit	8278236	1
18	9210-1590103	Pin 2x14	0248063	1
19	9210-1640141	Safety catch spring	0248070	1
20	9210-1230193	O-ring 2162	0248087	10
21	9210-1710265	Valve body	0263509	6
22	9210-1330110	Cap + seal OR2050	0255757	1
23	R318V	Bolt	8029500	1



Smooth black grips
For a perfect cutting action

Extremely strong, strain resistant, yet very light aluminium handles (different lengths available)

Soft shock absorbing buffers for maximum comfort



Centre bolt locking system for secure fixing

DIFFERENT CUTTING HEADS FOR DIFFERENT APPLICATIONS



30 mm
1 1/4"

P114 style

- ▶ Narrow cutting head for pruning in confined spaces

- ▶ Main areas of application:
 - ▶ Viticulture
 - ▶ Pomology with hedge-like cultivation (apple, pear)



30 mm
1 1/4"

P116 style (P116, P19, P16)

- ▶ Strongly curved large blade with a deep hooked counterblade
- ▶ Designed for pruning below waist height and towards the ground

- ▶ Main areas of application:
 - ▶ Viticulture
 - ▶ Pomology; including soft fruits
 - ▶ Landscaping (P19)



45 mm
1 1/2"

P160 style

- ▶ Narrow blade combined with deep hooked, thin counterblade
- ▶ Well balanced loppers designed for pruning above shoulder height

- ▶ Main areas of application:
 - ▶ Pomology
 - ▶ Landscaping

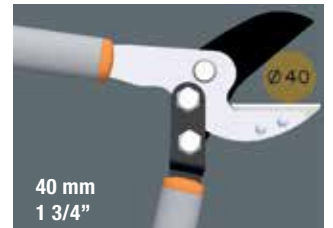

40 mm
1 3/4"

P172 style

- ▶ Strong blade with anti-friction coating (Xylan®), interchangeable anvil
- ▶ Lever action to facilitate the pruning of mature and dry wood

- ▶ Main areas of application:
 - ▶ Landscaping
 - ▶ Occasionally also used in Pomology



The evolving bevel technology is utilized on the P116-SL loppers and reinforces the slicing motion of the blade. This is an advantage when cutting thick branches.

SUPER LIGHT TOOLS

- ▶ Light weight, super-strong aluminium material provides strength and reduces fatigue and discomfort in use

SUPER
LIGHT



► **P19**



- Heavy duty bypass lopper for cutting very thick and large branches on mature trees
- Long handles for long reach and overhead cutting
- Spareparts available



	BAHCO		mm.	inch	mm.	inch	
P19-80-F	8275365	1	50	2	800	31 1/2	1790

► **P160**



- Specially designed for orchards, also recommended for landscaping
- Slim, narrow blade combined with hooked counter blade to benefit from powerful and smooth cut
- Long handles for easy reach and overhead cutting
- Spareparts available



	BAHCO		mm.	inch	mm.	inch	
P160-SL-60	8301170	2	45	1 3/4	600	23 1/2	960
P160-SL-75	8301187	1	45	1 3/4	750	30	1090
P160-SL-90	8301194	1	45	1 3/4	900	35	1160

► **P280**



- Heavy duty bypass lopper
- Xylan® anti-friction coating on the blade facilitates the penetration through the wood
- Lever action sliding system makes cutting easier; 50% power gain
- Spareparts available



	BAHCO		mm.	inch	mm.	inch	
P280-SL-80	8301330	2	55	1 1/2	800	31 1/2	1318

► **P172**



- Heavy duty anvil lopper for cutting mature and dry wood
- Xylan® anti-friction coating on the blade facilitates the penetration through the wood
- Lever action sliding system makes cutting easier; 50% power gain
- Spareparts available



	BAHCO		mm.	inch	mm.	inch	
P172-SL-85	8301200	1	40	1 1/2	850	33 1/2	1220

► **P116**



- Large cutting capacity
- Two edged radii blade with evolving bevel for better durability and easier cut in tough wood
- Spareparts available



	BAHCO		mm.	inch	mm.	inch	
P116-SL-40	8301101	2	30	1 1/4	400	15 3/4	687
P116-SL-50	8301118	2	30	1 1/4	500	19 3/4	735
P116-SL-60	8301125	2	30	1 1/4	600	23 1/2	879
P116-SL-70	8301132	2	30	1 1/4	700	27 1/2	964

► **P114**



- Narrow cutting head for easy access and precise, quick cuts
- Designed for soft and green wood
- Spareparts available



	BAHCO		mm.	inch	mm.	inch	
P114-SL-40	8301149	2	30	1 1/4	400	15 3/4	630
P114-SL-50	8301156	2	30	1 1/4	500	19 3/4	682
P114-SL-60	8301163	2	30	1 1/4	600	23 1/2	826

► **P16**



- For pruning and training fruit trees and grape vines
- Strongly curved blade with slicing cut for quick and powerful cuts
- Robust steel handles with soft rubber buffers to prevent fatigue
- Spareparts available



	BAHCO		mm.	inch	mm.	inch	
P16-40	8013479	2	30	1 1/4	400	15 3/4	790
P16-50-F	8301286	2	30	1 1/4	500	20	935
P16-60-F	8276461	2	30	1 1/4	600	24	1025

► **P16-40W**



- For pruning grape vines
- Special blade (R116VP) with a very thin honing angle
- For neat clean cuts
- Comfortable beech wood handles with soft buffers to prevent fatigue
- Spareparts available



	BAHCO		mm.	inch	mm.	inch	
P16-40W	8043049	2	30	1 1/4	400	16	795



► **PG-19**



- Blade with Xylan® coating for easier cut and rust protection
- For pruning live and green wood
- Super light telescopic bypass lopper for pruning high branches: extendable from 70 to 90 cm
- Special locking system locking by only turning in one direction
- Comfortable bi-material grips



	Icon 1	Icon 2	Icon 3	Icon 4	Icon 5	Icon 6	Icon 7
PG-19-F	8295936	2	40	1 1/2	700-900	27 1/2-35 1/2	1135

► **PG-17**



- For pruning mature and dry wood
- Super light telescopic anvil lopper for pruning high branches: extendable from 70 to 90 cm
- Special locking system locking by only turning in one direction
- Comfortable bi-material grips



	Icon 1	Icon 2	Icon 3	Icon 4	Icon 5	Icon 6	Icon 7
PG-17-F	8324629	2	30	1 1/4	700-900	27 1/2-35 1/2	1120

► **PG-18**



- For pruning shrubs and bushes in gardens
- Aluminium handles with comfortable bi-material grips, buffers integrated
- Available in two lengths



	Icon 1	Icon 2	Icon 3	Icon 4	Icon 5	Icon 6	Icon 7
PG-18-60-F	8288853	2	40	1 1/2	640	25	785
PG-18-45-F	8299033	2	40	1 1/2	450	17 3/4	545

► **P130/140**



- For pruning shrubs and bushes in gardens
- Curved blade with slicing cut for easy cutting
- Robust steel handles with integrated buffers
- Available in two lengths



	Icon 1	Icon 2	Icon 3	Icon 4	Icon 5	Icon 6	Icon 7
P140-F	8275372	2	35	1 3/8	600	24	1010
P130-F	8333980	6	40	1 1/2	450	17 3/4	775



► SPARE PARTS FOR LOPPERS

	R16V	8254513	1	P116-SL-40, P116-SL-50, P116-SL-60, P116-SL-70
	R16V-BULK14	8288334	14	P116-SL-40, P116-SL-50, P116-SL-60, P116-SL-70
	R115V	8243210	1	P114-SL-40, P114-SL-50, P114-SL-60
	R115V-BULK14	8288341	14	P114-SL-40, P114-SL-50, P114-SL-60
	R160A	8201821	1	P160-SL-60, P160-SL-75, P160-SL-90
	R119V	8029487	1	P19-80-F
	R380A	8000066	1	P172-SL-85
	R181P	8296087	1	P280-SL-80
	R116V	8010164	1	P16-50-F, P16-60-F
	R116V-BULK36	8159924	36	P16-50-F, P16-60-F
	R216SL	8301408	1	P116-SL-40, P116-SL-50, P116-SL-60, P116-SL-70
	R214SL	8301392	1	P114-SL-40, P114-SL-50, P114-SL-60
	R260A	8201814	1	P160-SL-60, P160-SL-75, P160-SL-90
	R619V	8029494	1	P19-80-F
	R372H	8235406	18	P172-SL-85
	R716VCB	8255497	1	P16-50-F, P16-60-F
	R166V	8328085	1	P116-SL & P114-SL
	R144PV	8291075	1	P160-SL-60, P160-SL-75, P160-SL-90
	R318V	8029500	1	P19-80-F
	R328V	8296056	1	P172-SL-85, P280-SL-80
	R143PVCB	8255633	1	P16-50-F, P16-60-F
R143PV-BULK50	8240837	50	P16-50-F, P16-60-F *	
	R415V	8243241	1	P116-SL & P114-SL
	R660V	8210281	1	P160-SL-60, P160-SL-75, P160-SL-90
	R519V	8029517	1	P19-80-F
	R772V	8301385	1	P172-SL-85
	R773V	8324414	1	P280-SL-80
	R615V	8010119	1	P16-50-F, P16-60-F
	R430V	8243265	1	P116-SL-40, P114-SL-40
	R440V	8254544	1	P116-SL-50, P116-SL-60, P116-SL-70, P114-SL-50, P114-SL-60
	R515VS	8046514	1	P160-SL-60, P19-80-F, P16-50-F, P16-60-F
	R516V	8200824	1	P160-SL-75, P160-SL-90, P280-SL-80
	R901P	8234195	1	P116-SL & P114-SL, P16-50-F, P16-60-F

* Only for loppers without centre bolt locking system













P160: BYPASS CUTTING HEAD



P172: ANVIL CUTTING HEAD

► FEATURES AND AREAS OF APPLICATION OF LOPPERS

Lopper Type	Application environment	Cutting head	Cutting head type				Lever action	Cutting capacity					Spare parts	
			114	116	160	P172		25-30 1"- 1 1/4"	30-35 1 1/4"- 1 3/4"	35-40 1 3/8"- 1 1/2"	40-45 1 1/2"- 1 3/4"	45-50 1 3/4"- 2"		
*** Highly Recommended ** Recommended * Acceptable	   	 												

Professional Loppers

P19-80-F			***		✓			✓						✓	✓
P160 (range)		***	**		✓			✓				✓	✓		✓
P280-SL-80		*	*	***	✓					✓				✓	✓
P172-SL-85		***	**			✓			✓	✓			✓		✓
P116 (range)	***	***			✓			✓			✓				✓
P114 (range)	***	*			✓		✓				✓				✓
P16 (range)	***	***	*	*	✓			✓				✓			✓

Garden Loppers

PG-19-F			***	✓								✓			
PG-17-F			***		✓							✓			
PG-18 (range)			***	✓								✓			
P140-F			***	✓								✓			
P130-F			***	✓								✓			



► ASSORTMENT OF LOPPERS

Professional Loppers

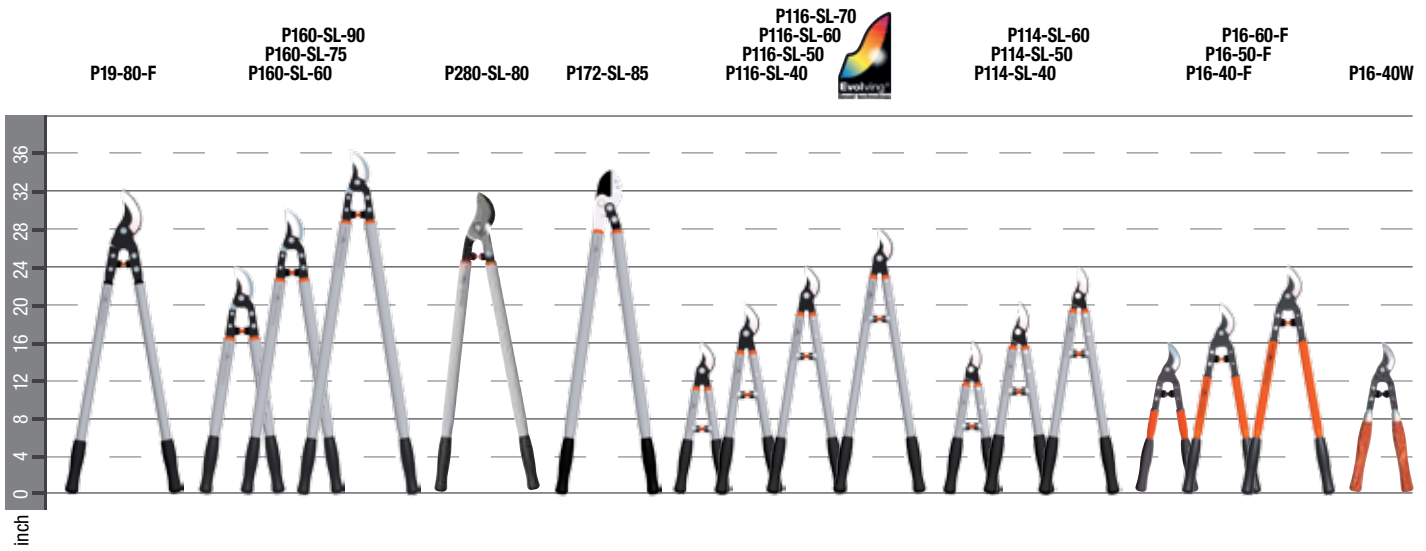

Garden Loppers

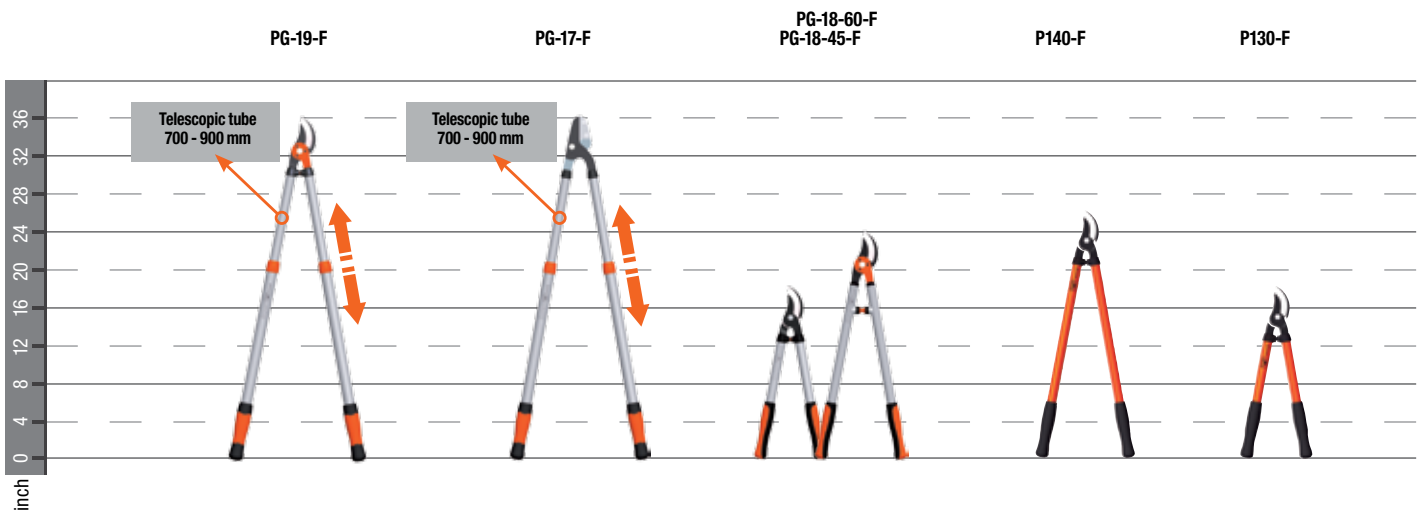

▶ PRUNING SAWS



THE SAW TOOTH PERFORMS THREE FUNCTIONS

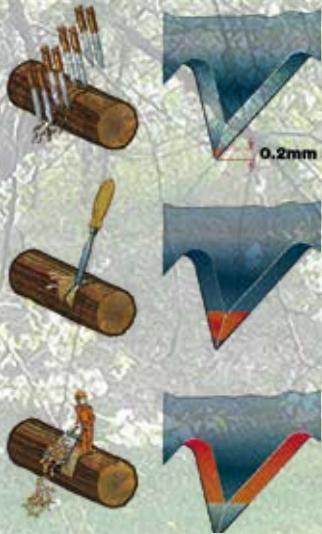

▶ **Cutting**

Teeth tips are small knives which cut through the wood fibres. Only 0,2 mm (0.008 inch) of the tooth is used for this function, which is done by the sharp, ground tip

▶ **Separating**

Teeth edges are chisels that shave wood from between the cuts

▶ **Clearing**

Gullets collect saw dust to deposit it outside the kerf. For this an open and smooth ground surface is needed in the gullet

▶ TOOTH DESIGN

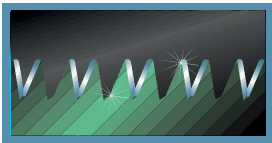

▶ **JT-Tooth**

50° cutting angle, triple grinding, long teeth with narrow bullets, non-set but taper ground blade. Quick and smooth cut and better performance

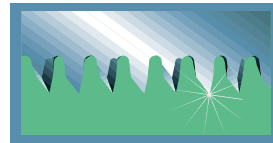

▶ **JS-Tooth**

45° cutting angle, wide gullets for removal of wood chips, taper ground blade with non-set tooth design for very fast and aggressive cutting

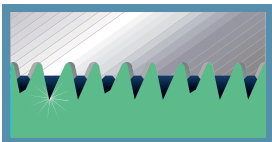

▶ **XT-Tooth**

Triangular shape, every third tooth is cut off and set to help with the removal of wood chips out of the kerf

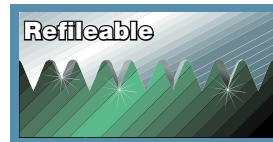

Refileable

▶ **Standard Tooth**

Triangular shape, all teeth are set, with hard points or refileable



Hard-Point

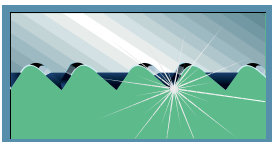

▶ **Hard-Point**

Teeth being heat treated after grinding. Hardened teeth remain 6 to 8 times longer and are more flexible, but cannot be resharpened with a file

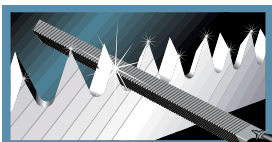

▶ **Fileable**

Teeth can be resharpened with Bahco file 4-272 (see p. 55)



▶ **Flexible and unbreakable blade**

▶ JT BLADES: IMPROVED PERFORMANCE

For a clean and fast pruning of live and green wood. Ideal for winter pruning.



▶ 41-JT



- ▶ Sword saw designed for wine and fruit growing
- ▶ Unset toothing for a smooth cutting surface
- ▶ Two different blade lengths offered
- ▶ Replacement blade available
- ▶ Always supplied with a holster

	73181*	mm.	inch			
4124-JT-H	8267803	4	240	9 1/2	7	365
4128-JT-H	8267810	4	280	11	7	370

▶ 396-JT



- ▶ Folding pruning saw designed for occasional use in viticulture and pomology
- ▶ Safety lock both in opened and closed position
- ▶ Replacement blade available

	73181*	mm	inch			
396-JT	8168056	4	190	7 1/2	7	200





► JS BLADES

Very aggressive toothing for an extremely fast and easy cut for green wood and thick branches

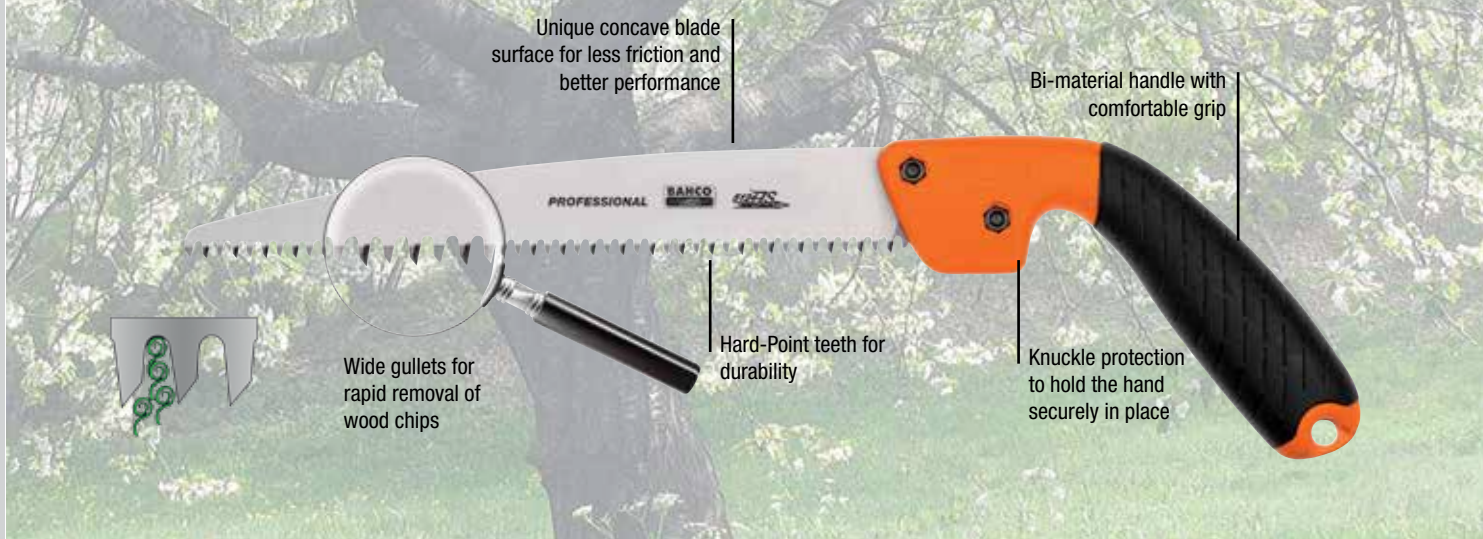

► 51-JS



- Sword saw especially designed for landscaping
- Extremely sharp and aggressive toothing for fast cut
- Two different blade lengths offered
- Replacement blade available
- Always supplied with a holster

► 396-JS



- Folding pruning saw designed for occasional cutting of thicker branches in pomology, viticulture and landscaping
- Safety lock both in opened and closed position
- Replacement blade available

	5124-JS-H	5128-JS-H	Blade Length	Blade Width	Blade Thickness	Weight
5124-JS-H	8219352	4	240	9 1/2	5	365
5128-JS-H	8219369	4	280	11	5	370

	396-JS	Blade Length	Blade Width	Blade Thickness	Weight
396-JS	8223250	4	190	7 1/2"	5
					200



▶ XT BLADES

For pruning all varieties of mature and dry wood



▶ 396-HP



- ▶ Multipurpose folding pruning saw performing well in both mature dry wood and live green wood
- ▶ Safety lock both in opened and closed position
- ▶ Replacement blade available

396-HP	8152284	4	190	7 1/2	7	200

▶ 396-LAP



- ▶ General-purpose folding saw for cutting both green and dry wood, plastic, bone, etc.
- ▶ Specially designed for wildlife enthusiasts, hunters and campers
- ▶ XT hardpoint tothing, 7 TPI. Blade specially coated for rust protection and low friction
- ▶ 2-component plastic handle for perfect grip, with leather strap. Safety lock, locked also when folded

396-LAP	8172367	10	190	7 1/2	7	200

▶ 349



- ▶ Ideal sword saw for domestic pruning ornamental and fruit trees
- ▶ Black anti-friction coating for rust protection, easy cut and maintenance-free use

349	8018924	4	300	12	7	225

▶ PG-72



- ▶ Folding saw for domestic occasional pruning when a secateur or a lopper is not sufficient
- ▶ Black anti-friction coating for rust protection, easy cut and maintenance-free use

PG-72	8242534	4	190	7 1/2	7	196

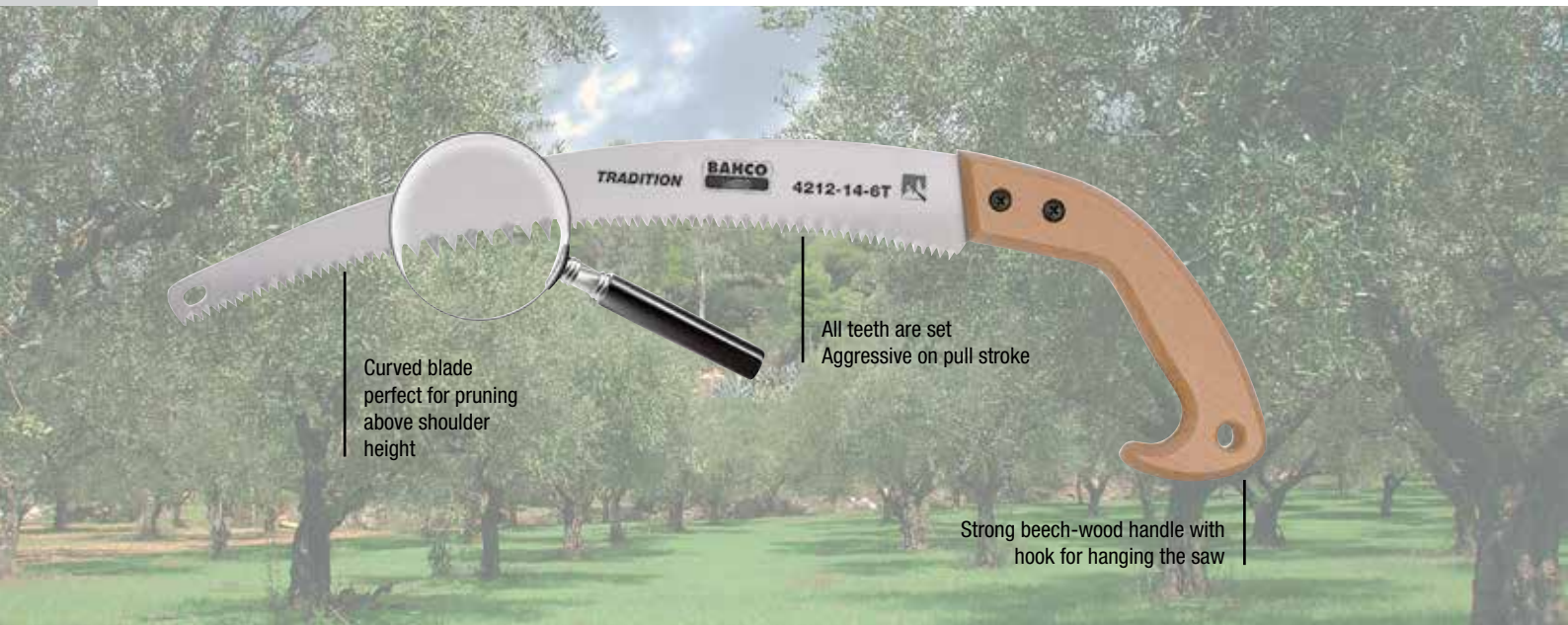

Curved blade perfect for pruning above shoulder height

All teeth are set Aggressive on pull stroke

Strong beech-wood handle with hook for hanging the saw

► **4211 / 4212**



- Pruning saw for mature and dry wood
- Two different blade lengths offered
- **4211** Hard-Point teeth
- **4212** fileable
- Replacement blade available

	HEAD TESTER		mm	inch		
4211-11-6T	8152000	4	280	11	6	225
4211-14-6T	8128883	4	360	14	6	280
4212-11-6T	8002060	4	280	11	6	225
4212-14-6T	8002077	4	360	14	6	280



▶ POLE SAWS

▶ 385 / 386



- ▶ Pole pruning saw with steel tube handle
- ▶ To be used with extension pole (Ø 25 mm, 1")
- ▶ Fits poles AP-3M, AP-5M, FP-3M
- ▶ Blade with a hook at the end to prevent the saw from slipping out of the kerf
- ▶ **385** fileable
- ▶ **386** Hard-Point teeth

385-6T	8002053	4	360	14	6	410	
386-6T	8152017	4	360	14	6	410	

▶ 383 / 384



- ▶ Pole pruning saw with steel tube handle
- ▶ To be used with extension pole (Ø 25 mm, 1")
- ▶ Fits poles AP-3M, AP-5M, FP-3M
- ▶ For softer wood like pine and spruce the more aggressive 384-5T (5TPI) is recommended
- ▶ **383** Hard-Point teeth
- ▶ **384** fileable

383-6T	8128876	4	360	14	6	320	
384-6T	8002039	4	360	14	6	320	
384-5T	8159795	4	360	14	6	320	



▶ 339 / 340







- ▶ Combination pruning saw with plastic handle
- ▶ Can be used as hand saw or with extension pole (Ø 25 mm, 1")
- ▶ Fits poles AP-3M, AP-5M, FP-3M
- ▶ **339** Hard-Point teeth
- ▶ **340** fileable
- ▶ Replacement blades available

339-6T	8128371	4	360	14	6	250	
340-6T	8002008	4	360	14	6	250	

▶ SPARE BLADES FOR PRUNING SAWS

	4724-JT	8265847	1	4124-JT-H	HARD-POINT	24 cm - 9,45"
	4728-JT	8265854	1	4128-JT-H	HARD-POINT	28 cm - 11"
	5724-JS	8216085	1	5124-JS-H	HARD-POINT	24 cm - 9,45"
	5728-JS	8216092	1	5128-JS-H	HARD-POINT	28 cm - 11"
	396-JT-BLADE	8168063	1	396-JT	HARD-POINT	19 cm - 7,5"
	396-JS-BLADE	8223267	1	396-JS	HARD-POINT	19 cm - 7,5"
	396-HP-BLADE	8156404	1	396-HP	HARD-POINT	19 cm - 7,5"
	396-BLADE-1P	8330613	1	396-LAP	HARD-POINT	19 cm - 7,5"
	4420-11	8200619	10	4211-11-6T	HARD-POINT	28 cm - 11"
	4400-11-BULK	8200633	10	4212-11-6T	FILEABLE	28 cm - 11"
	4420-14	8200626	10	4211-14-6T, 339-6T	HARD-POINT	36 cm - 14"
	4400-14-BULK	8200640	10	4212-14-6T	FILEABLE	36 cm - 14"
	4400-11	8200596	10	4212-11-6T	FILEABLE	28 cm - 11"
	4420-11-BULK	8200657	10	4211-11-6T	HARD-POINT	28 cm - 11"
	4400-14	8200602	10	4212-14-6T, 340-6T	FILEABLE	36 cm - 14"
	4420-14-BULK	8200664	10	4211-14-6T	HARD-POINT	36 cm - 14"

► FEATURES AND AREAS OF APPLICATION OF PRUNING SAWS

Saw Type	Application environment	User	Features			
*** Highly Recommended ** Recommended * Acceptable	   	Professional or Gardener	Handle material	Hand-held or Pole mountable	Hard-Point or Fileable	Replacement blade

Professional Saws

4124-JT-H	***	***	*	*	Professional	Bi-material	Hand	Hard-Point	4724-JT
4128-JT-H	***	***	*	*	Professional	Bi-material	Hand	Hard-Point	4728-JT
5124-JS-H	**	***	***	*	Professional	Bi-material	Hand	Hard-Point	5724-JS
5128-JS-H	**	***	***	*	Professional	Bi-material	Hand	Hard-Point	5728-JS
396-JT	***	**	*	*	Professional	Bi-material	Hand	Hard-Point	396-JT-BLADE
396-JS	*	***	***	*	Professional	Bi-material	Hand	Hard-Point	396-JS-BLADE
396-HP	**	**	**	*	Professional	Bi-material	Hand	Hard-Point	396-HP-BLADE
4211-11-6T	*	***	***	*	Professional	Beech-wood	Hand	Hard-Point	4420-11
4212-11-6T	*	***	***	*	Professional	Beech-wood	Hand	Fileable	4400-11
4211-14-6T	*	***	***	*	Professional	Beech-wood	Hand	Hard-Point	4420-14
4212-14-6T	*	***	***	*	Professional	Beech-wood	Hand	Fileable	4400-14
383-6T		***	***	**	Professional	Steel	Pole	Hard-Point	No
384-6T		***	***	*	Professional	Steel	Pole	Fileable	No
384-5T		***	***	*	Professional	Steel	Pole	Fileable	No
385-6T		***	***	**	Professional	Steel	Pole	Fileable	No
386-6T		***	***	*	Professional	Steel	Pole	Hard-Point	No

Garden Saws

339-6T	*	*	*	***	Gardener	Plastic	Hand/Pole	Hard-Point	4420-14
340-6T	*	*	*	***	Gardener	Plastic	Hand/Pole	Fileable	4400-14
349				***	Gardener	Bi-material	Hand	Hard-Point	No
PG-72				***	Gardener	Bi-material	Hand	Hard-Point	No

► ASSORTMENT OF PRUNING SAWS

Professional Saws		inch	0	1	2	3	4	5	6	7	8	9	10	11	12	13	14	15	16
5124-JS-H	Sharp and aggressive JS saw for a fast and easy cut – Ideal for green wood and thick branches.																		
5128-JS-H																			
4124-JT-H	Designed for clean and fast pruning of green wood with improved performance – Ideal pruning saw for winter pruning.																		
4128-JT-H																			
396-JT	Folding saw with lockable blade and comfortable handle. Can be carried in a holster or pocket while other work is done.																		
396-JS																			
396-HP																			
4211-11-6T	Lightweight pruning saw with 11" blade and hard wood handle. 6 teeth per inch cutting edge ensures a fast, aggressive cut in mature and dry wood.																		
4212-11-6T																			
4211-14-6T	Hand-held pruning saw with 14" blade and hard wood handle. The longer blade allows a longer saw-stroke for faster cutting of larger diameter branches.																		
4212-14-6T																			
383-6T	Pole saw with steel tubes that fit on AP-3M, AP-5M and FP-3M telescopic poles. 383-6T and 384-6T: 6 teeth per inch. 384-5T: 5 teeth per inch - more aggressive so recommended for softer wood like pine and spruce. 385-6T and 386-6T blade with hook to prevent the saw from slipping out of the kerf.																		
384-6T																			
384-5T																			
385-6T																			
386-6T																			

Garden Saws																			
339-6T	Combination hand-held / pole saw for occasional work in the garden.																		
340-6T																			
349	Hand-held straight pruning saw (349) and folding saw (PG-72) for occasional work in the garden.																		
PG-72																			

Outdoor activities																			
396-LAP	General-purpose folding saw for cutting both green and dry wood. Specially designed for wildlife enthusiasts, hunters and campers.																		



TOP PRUNERS



The top pruner was invented by our production unit in France back in 1934. It was developed to cover the requirement of a tool to prune trees above normal working height without carrying a ladder around. It should be used together with an extension pole. With this combination, it is possible to cut branches at a height of up to 6 m (19.7”).

► P34-37



- Triple pulley reduces the amount of effort required
- Adjustable clamp fits Ø 25 mm (1”) to 35 mm (1 3/8”) poles
- Supplied with a 5 m rope and handle
- Pruning saw blade can be mounted on this top pruner
- Spare parts available

► P34-27A



- Steel clamp tighten with screws
- Fits Ø 25 mm (1”) poles
- Supplied with a 5 m rope
- Spare parts available

P34-37	8002787	2	40	1 1/2	1260

P34-27A-F	8275464	2	30	1 1/4	610

► SPARE PARTS FOR TOP PRUNERS

	R124PG	8010089	1	P34-27A-F
	R137E	8011574	1	P34-37
	R133PG	8328252	1	P34-27A-F
	R142P	8010126	1	P34-27A-F
	R337E	8011598	1	P34-37
	R427AE	8176068	1	P34-27A-F
	R437E	8011611	1	P34-37

▶ POLES



The three light weight telescopic poles are made of aluminium or fibreglass. These poles are supplied with the bolt and wing nut to secure saw on pole. When extended to the desired length, they can be locked by simply twisting the upper pole against the lower.

AP- 3M - Aluminium



Contracted

2.00 m

Extended

3.50 m

AP- 5M - Aluminium



2.00 m

5.00 m

FP- 3M - Fibreglass



1.80 m

3.20 m

▶ AP / FP



- ▶ Extension poles to work at height
- ▶ Aluminium AP or fibreglass FP
- ▶ Top diameter 25 mm, 1"
- ▶ Supplied with a bolt and wing nut
- ▶ Fits top pruners (P34-37, P34-27A-F) and pole pruning saws (339-6T, 340-6T, 383-6T, 384-6T, 385-6T)

				mm.	inch	
AP-3M	8152062	1		2000 - 3500	6' 7" - 11' 6"	1000
AP-5M	8152079	1		2000 - 5000	6' 7" - 16' 5"	1600
FP-3M	8168612	1		1800 - 3200	5' 11" - 10' 6"	1000

▶ AP-234



- ▶ Top pruner with two functions, for pruning and clearing out
- ▶ **Clearing out:**
Simply hook the counterblade around the branch you wish to cut and pull the pole towards you
- ▶ **Pruning:**
Hook the counterblade around the branch and pull the rope down with the orange handle
- ▶ Fully hardened steel blade with slicing action for neat and efficient cut
- ▶ Long aluminum pole for difficult-to-reach branches

				mm.	inch	mm.	inch	
AP-234-F	8289027	2		30	1 1/4	2200	87	1520



CLEARING OUT



PRUNING

BOW SAWS



TWO DIFFERENT TOOTHINGS ACCORDING TO THE APPLICATION

51: Peg toothing for mature and dry wood

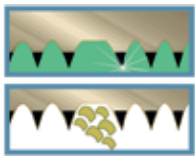

- ▶ Triangular set teeth, tips pointing downwards
- ▶ Bevel filed and high-frequency hardened with sharp edges on both sides
- ▶ Hard-Point
- ▶ Every third gullet extended for high chip removal
- ▶ Cut on both push and pull stroke
- ▶ Specifically designed for fast and effective cutting of mature and dry wood

23: Raker toothing for live and green wood

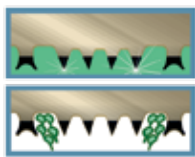

- ▶ Triangular set teeth, tips pointing downwards
- ▶ Bevel and filed and high-frequency hardened with sharp edges on both sides
- ▶ Hard-Point
- ▶ Every fifth tooth is raker and unset which functions like a chisel to remove the chips out of the green wood
- ▶ Cut on both push and pull stroke

SPARE PARTS FOR BOW SAWS

				mm	
	51-21	8003906	10	530	10-21-51, 332-21-51, 332-21-51-KP, SE-16-21, SE-16-21-23
	51-24	8003913	10	607	10-24-23, 10-24-51, SE-15-24
	51-30	8003920	10	759	10-30-23, 10-30-51, SE-15-30, SE-15-30-23
	51-32	8003937	10	810	SE-15-32
	51-36	8003944	10	912	SE-15-36, SE-15-36-23
	23-15	8274665	10	380	331-15-23
	23-21	8012274	10	530	10-21-51, 332-21-51, 332-21-51-KP, SE-16-21, SE-16-21-23
	23-24	8003852	10	607	10-24-23, 10-24-51, SE-15-24
	23-30	8003869	10	759	10-30-23, 10-30-51, SE-15-30, SE-15-30-23
	23-32	8003876	10	810	SE-15-32
	23-36	8003883	10	912	SE-15-36, SE-15-36-23
	333-5	8005849	10	350	333

► **10 ergo®**



- Heavy-duty bow saw made from high-quality steel, protected from rust and corrosion by a coating of high impact enamel paint
- Designed for demanding applications and tough environments such as construction sites
- Innovative tensioning mechanism for high blade tension (up to 120 kg) and straight cutting
- ERGO™ handle with knuckle protector gives ergonomic comfort and safety

10-21-51	8229344	5	530	21	51	680	
10-24-23	8229368	5	604	24	23	743	
10-24-51	8229351	5	604	24	51	743	
10-30-23	8229382	5	760	30	23	865	
10-30-51	8229375	5	760	30	51	865	

► **331**



- Small and handy bow saw for all-round use
- The pointed nose makes the saw ideal for use in tight spaces, such as pruning and roofing work

331-21-51-KP	8003814	5	530	21	51	615	
331-15-23	8274658	5	378	15	23	375	

► **SE-15/16**

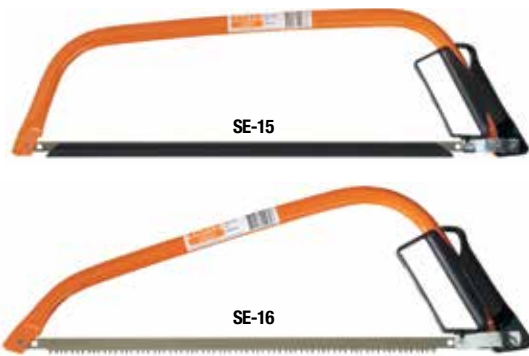

- For all types of work, especially in building, gardening, farming and forestry applications
- Powder painted steel tube for excellent rust protection
- Teeth points high-frequency, heat-induction hardened for long-lasting performance
- The knuckle protector gives comfort and safety
- SE-16-21 with pointed nose for better access in tight areas

SE-15-24	8029838	5	610	24	51	675	
SE-15-30	8029821	5	760	30	51	800	
SE-15-30-23	8029845	5	760	30	23	800	
SE-15-32	8249168	5	810	32	51	840	
SE-15-36	8141202	5	910	36	51	920	
SE-15-36-23	8258276	5	910	36	23	920	
SE-16-21	8029807	5	530	21	51	570	
SE-16-21-23	8273934	5	530	21	23	570	

► **332 ergo®**



- Light weight, heavy-duty bow saw made from high-quality steel, protected from rust and corrosion by a coating of high-impact enamel paint
- Pointed nose for better access in tight areas, such as roofing and gardening
- Innovative tensioning mechanism for high blade tension (up to 120 kg) and straight cutting
- ERGO™ handle with knuckle protector gives ergonomic comfort and safety

332-21-51	8229337	5	530	21	51	663	

► **333**



- General-purpose bow saw for gardening and home repairs
- The steel frame has special blade holders with an extra strong blade attachment mechanism
- Reversible blade, hardened for durability, which can be rotated around its long axis

333	8005832	5	350	14	615		



HEDGE SHEARS

SUPER 
LIGHT

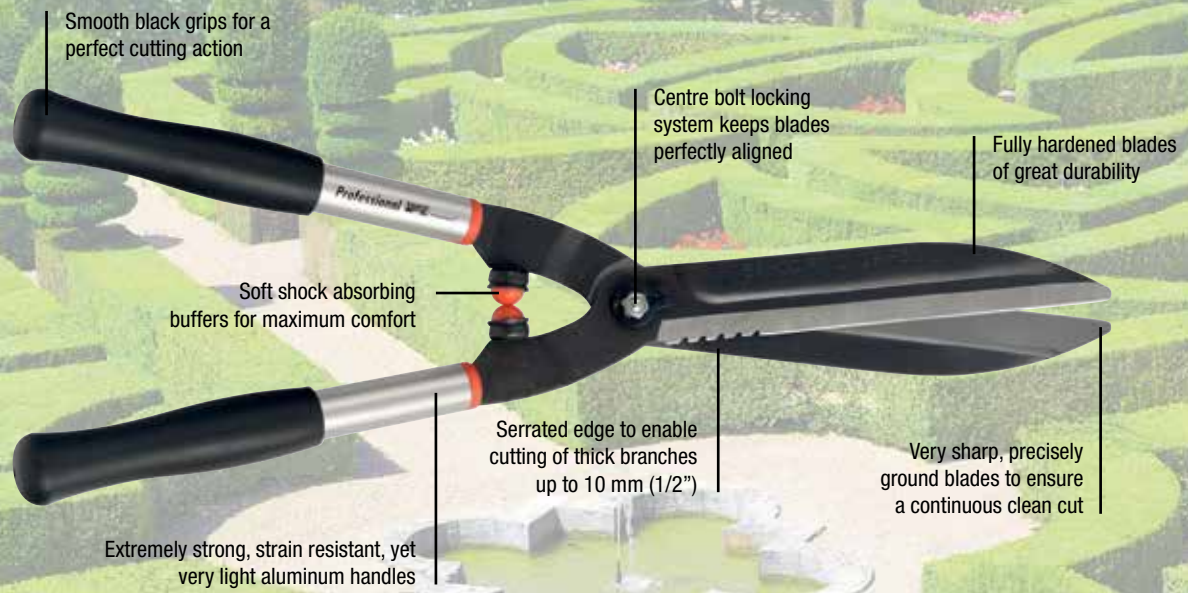

THREE MAIN TYPES OF SHEAR BLADES



- ▶ Large blades with partly serrated edges for hedge trimming on plants with thicker twigs
- ▶ Main area of application:
 - ▶ Landscape



- ▶ Narrow blades with smooth edges for trimming leaves and soft shoots, very clean cut
- ▶ Main areas of application:
 - ▶ Landscape: topiary
 - ▶ Viticulture: leaf pruning



- ▶ Wavy blades with smooth edges for pruning hedges and shrubs with a fairly open structure and soft shoots. The waves trap groups of twigs and prevent them from sliding out of the blade.
- ▶ Main area of application:
 - ▶ Landscape

SUPER LIGHT TOOLS

- ▶ Light weight, super-strong aluminum material providing strength and reduces fatigue and discomfort in use

SUPER 
LIGHT

SUPER
LIGHT



► **P51-SL**



- For professional use in parks, vineyards and topiary art work
- Partly serrated edge for cutting up to 10 mm [3/8"] thick branches
- Spare parts available

				mm.	inch	
P51-SL	8301217	2	570	22 1/2	990	

► **P51H-SL**



- For professional use in parks, vineyards and topiary art work
- Partly serrated edge for cutting up to 10 mm [3/8"] thick branches
- 36 cm [14"] longer handles for extended cutting range
- Spare parts available

				mm.	inch	
P51H-SL	8301224	2	730	28 3/4	1076	

► **P54-SL**



- Slim straight blade available in 20 cm and 25 cm
- Compact design and angled form makes the tool perfect to use on topiary plants and trellis systems
- Spare parts available

				mm.	inch	
P54-SL-20	8301248	2	500	19 3/4	742	
P54-SL-25	8301231	2	550	21 1/2	813	

► **P54H-SL**



- Slim straight blade available in 20 cm and 25 cm
- Designed with 36 cm long handles for all types of leaf cutting and plant shaping where a long reach is required
- Spare parts available

				mm.	inch	
P54H-SL-20	8301262	2	600	23 1/2	787	
P54H-SL-25	8301255	2	650	25 1/2	871	

► **P51**



- For intensive professional use in parks, vineyards and topiary art work
- Partly serrated edge for cutting up to 10mm [3/8"] thick branches
- Spare parts available

				mm.	inch	
P51-F	8275426	2	570	23	1085	



► **P57-25**



- Traditional hedge shears with comfortable wooden handles
- Straight blade with partly serrated edge for cutting up to 10mm [3/8"] thick branches
- Spare parts available

				mm.	inch	
P57-25-F	8301293	4	540	21 1/4	1020	

► **P57-25-W**



- Traditional hedge shears with comfortable wooden handles
- Wavy blade shears preventing groups of twigs sliding along the blade during the cut; ensures a uniform finish of to the hedge
- Spare parts available

				mm.	inch	
P57-25-W-F	8301309	4	540	21 1/4	1020	



► PG-57



- Super light telescopic hedge shear: extendable from 80 to 105 cm
- Special locking system locking by only turning in one direction
- Comfortable bi-material grips

PG-57-F	8295943	2	800 - 1050	31 - 42	1345

► PG-56



- Super light hedge shear for trimming all kind of hedges
- Comfortable bi-material grips

PG-56-F	8288938	2	540	26	950



► P59-25



- Universal hedge shears with robust steel handles
- For regular hedge trimming in gardens

P59-25-F	8275655	5	590	26	1115



► SPARE PARTS FOR HEDGE SHEARS

	R146VC	8046545	1
	R147V	8044909	1
	R515VS	8046514	1
	R516V	8200824	1
	R440V	8254544	1
	R444V	8243340	1

▶ GRASS SHEARS

▶ GS-180



- ▶ Single handed grass shears with stainless steel blades carefully set for self-grinding during use
- ▶ Rotating head (180°) for lawn edging swivels easily into different positions to facilitate the cut on slopes
- ▶ Soft touch and non-slip grip on upper handle for maximum comfort, lower handle loop for finger protection

GS-180-F	8275488	6	375 mm.	15 inch	317



▶ GS-76



- ▶ Hardened blades, angles carefully set for self-grinding during use
- ▶ Rotating easily into three positions enabling the user to gain access to difficult-to-reach corners

GS-76	8010782	6	355 mm.	14 inch	435



P74



P75

▶ P74



- ▶ Lawn shear for cutting in difficult-to-reach places where lawn mowers cannot gain access
- ▶ Doubled bevelled blade and flat-edged counterblade, fully hardened with black Xylan® coating
- ▶ Horizontal oriented blades, also known as duck's foot
- ▶ Straight cutting edge, 20 cm length, plastic buffers to reduce jarring
- ▶ 90 cm long handles of round steel tubes, fitted with black plastic sleeve

P74	8124076	1	1100 mm.	44 inch	2000

▶ P75















- ▶ Lawn shear for trimming borders in areas where lawn mowers and trimmers cannot pass
- ▶ Doubled bevelled blade and flat-edged counterblade, fully hardened with black Xylan® coating
- ▶ Straight cutting edge, 20 cm length, plastic buffers to reduce jarring
- ▶ 90 cm long handles of round steel tubes, fitted with black plastic sleeve

P75	8124083	1	1000 mm.	39 inch	1900

▶ SPARE PARTS FOR GRASS SHEARS

	R146VC	8046545	1		P74, P75
	GS-76-SPRING-L	8332952	1		GS-76

► FEATURES AND AREAS OF APPLICATION OF HEDGE SHEARS

Hedge Shear Type	Application environment	Cutting head type				Dimensions		Spare parts
		 Straight Blades	 Narrow Blades	 Wavy Blades	 Serrated edge	Blade Length cm / inch	Handle Length cm / inch	
*** Highly Recommended ** Recommended * Acceptable	   							

Professional Hedge Shears

P51-SL	**		***	*	✓			✓	26 cm / 10 1/2"	30 cm / 12"	yes
P51H-SL	**		***	*	✓			✓	26 cm / 10 1/2"	45 cm / 18"	yes
P51-F	**		***		✓			✓	26 cm / 10 1/2"	30 cm / 12"	yes
P54-SL-20	**		***			✓			20 cm / 8"	26 cm / 10 1/2"	yes
P54-SL-25	**		***			✓			25 cm / 10"	26 cm / 10 1/2"	yes
P54H-SL-20	**		***			✓			20 cm / 8"	36 cm / 14 1/5"	yes
P54H-SL-25	**		***			✓			25 cm / 10"	36 cm / 14 1/5"	yes
P57-25-F			***	**	✓			✓	25 cm / 10"	28 cm / 11"	yes
P57-25-W-F			***	**			✓		25 cm / 10"	28 cm / 11"	yes

Garden Hedge Shears

PG-56-F				***	✓				22 cm / 8 1/2"	33 cm / 13"	
PG-57-F				***	✓				22 cm / 8 1/2"	80-105 cm / 23-32"	
P59-25-F				***	✓				25 cm / 10"	33 cm / 13"	



► ASSORTMENT OF HEDGE SHEARS

Professional Hedge Shears

	P51-SL	P51H-SL	P51-F	P54-SL-20	P54-SL-25	P54H-SL-20	P54H-SL-25	P57-25-F	P57-25-W-F	
inch										
	<p>The P51 range is the prize winning, top-of-the-range professional quality shear. Accuracy, sharpness and balance make them ideal for hedge trimming on plants with thicker wigs. The P51 makes light work of cutting back the tough stems of overgrown bushes.</p>			<p>The compact design with angled forms of the P54-SL makes the tool perfect to use on topiary plants and trellis systems. The P54H-SL has been designed with 36 cm long handles for all types of leaf cutting and plant shaping where a long reach is required.</p>				<p>The P57 range feature tradition wooden handles. The blades are uncoated to allow for hand-sharpening.</p>		

Garden Hedge Shears

	PG-57-F	PG-56-F	P59-25-F	
inch				
	<p>Bahco garden hedge shears are designed with the same consideration for the user as the professional tools. Intended specifically for the discerning private consumer who expects to prune a few trees once or maybe twice a year.</p>			

- The garden range offers some distinct features:
- Comfortable 2-component handles
 - Extendable handles
 - No spare parts available



▶ KNIVES

▶ P11



- ▶ High-quality grafting knife for razor-sharp cutting of the graft and bark
- ▶ Spatula with round edges for lifting of the bark for the graft insertion
- ▶ Extremely sharp folding blade, folding brass spatula and plastic cover for comfortable grip

P11	8009076	6	180 mm.	7 inch	70

▶ P20



- ▶ High-quality pruning knife for pruning of very delicate trees such as peach
- ▶ Also used for pruning young trees in nurseries and for thinning out fruit branches
- ▶ Special hook design of the folding blade and plastic cover for comfortable grip

P20	8009281	6	200 mm.	8 inch	10

▶ 2444



- ▶ Robust knife with a solid stainless steel blade for multipurpose use
- ▶ Bi-material handle for comfort in use
- ▶ Supplied with a practical sheath for belt carrying
- ▶ 2444: counter display of 15 pcs
- ▶ SB-2444: on card

2444	8286750	15	220 mm.	8.66 inch	100
SB-2444	*0189250	1	200 mm.	8.66 inch	100
EAN code (*) 731415+					

▶ 1446



- ▶ Robust knife with a solid stainless steel blade for multipurpose use
- ▶ Single component handle for comfort in use and a safe grip
- ▶ Overall product length 220 mm, blade length 100 mm
- ▶ Supplied with a practical sheath for belt carrying
- ▶ Available in a 15 pce counter display

1446	*0128631	15	220 mm.	8.66 inch	110
EAN code (*) 731415+					

▶ K-AP-1



- ▶ For all gardening work such as pruning, flower cutting and cutting of strings, plastics and paper material
- ▶ Stainless steel, bow-shaped folding blade
- ▶ Very flat design to fit into the pocket

K-AP-1	8030117	10	180 mm.	7 inch	90

▶ K-GP-1



- ▶ For all gardening work such as pruning, flower cutting and cutting of strings, plastics and paper material
- ▶ Stainless steel, hook-shaped folding blade
- ▶ Very flat design to fit into the pocket

K-GP-1	8030131	10	170 mm.	6 3/4 inch	90

▶ 2444-LAP



- ▶ Robust knife with a solid stainless steel blade for multipurpose use
- ▶ 2-component handle for comfort in use and a safe grip
- ▶ Overall product length 220 mm, blade length 102 mm
- ▶ Supplied with a practical sheath for belt carrying

2444-LAP	0237463	10		130

▶ LAP-KNIFE



- ▶ Saw specially designed for wildlife enthusiasts, hunters, etc.
- ▶ XT hardpoint toothing for cutting both green and dry wood, plastic and bone, etc.
- ▶ Blade specially coated for rust protection and low friction
- ▶ 2-component plastic handle for perfect grip, with leather strap
- ▶ Safety lock, locked also when folded
- ▶ Robust knife with a solid stainless steel blade, multipurpose use
- ▶ Overall product length 220 mm, blade length 102 mm
- ▶ Supplied with a practical sheath for belt carrying

LAP-KNIFE	8216443	10		29

▶ SCISSORS



▶ FS-5



- ▶ Ideal for pruning delicate plants, for clearing out faded flowers and dry leaves, for pruning and harvesting herbs and for creating floral decoration
- ▶ Floral scissor with stainless steel blades and soft touch finger loops
- ▶ Short pointed blades with micro serration are designed for cutting soft stems of small diameter

FS-5	8266455	10	125	5	24



▶ FS-7.5



- ▶ Floral scissor with stainless steel blades and soft touch finger loops
- ▶ Compact strong blades with serration are designed for all kind of flower stems and twigs as well as ribbons, cardboard and even soft wire
- ▶ Also used for pruning small shrubs on the balcony and indoor plants

FS-7.5	8266479	10	200	8	108



▶ FS-8



- ▶ Floral scissor with stainless steel blades and soft touch finger loops
- ▶ Long straight blades with micro serration are designed for cutting soft stems of small diameter, ribbons, any kind of paper, thin cardboard and tissues used in floral decoration
- ▶ Also used for pruning indoor plants, clearing out faded flowers and dry leaves in difficult to reach places

FS-8	8266462	10	165	6 1/2	47



▶ BORDER AND SMALL GARDEN TOOLS

Precise, useful and robust, the border tools are long reach tools designed for better accessibility to wider borders and under shrubs

Comfortable bi-material handle with round shape

Head made of fully hardened steel with epoxy powder coating for rust protection

Label can be cut off so that remaining loop can serve as hanger



▶ P272



- ▶ Border hoe for breaking the ground and loosening clogged soil
- ▶ To prepare the soil before sowing

			mm.	inch	
P272	8299354	5	430	16.9	250

▶ P274



- ▶ Border cultivator for loosening and aerating the soil
- ▶ For controlling weeds through uprooting their seedlings

			mm.	inch	
P274	8299347	5	455	17.9	210

▶ P276



- ▶ Border rake for cleaning and levelling the soil around the plants

			mm.	inch	
P276	8299361	5	440	17.3	250

▶ P277



- ▶ Two-point border hoe
- ▶ Versatile tool for different jobs
- ▶ Hoe blade for loosening the ground and for breaking clogged soil or cutting weeds
- ▶ Two-prong fork for loosening the soil to aerate

			mm.	inch	
P277	8299378	5	435	17.1	260

▶ P278



- ▶ One-point border hoe for preparing the soil and sowing or transplanting
- ▶ Broad hoe blade for breaking clogged soil and for weeding
- ▶ Pointed hoe blade for making rows and furrows for sowing and planting

			mm.	inch	
P278	8299385	5	435	17.1	260

Small garden tools are designed for tending plants in rock gardens, on balconies, in containers and raised beds

► **P269**



► **Daisy grubber:** special weeding tool to cut and lift deep rooting weeds like dandelions, thistles and certain umbelliferae

P269	8299323	10	315	12.4	140

► **P270**



► **Weeding fork** for loosening, cleaning and levelling the ground before planting
► For harvesting root vegetables like radishes or carrots on small plots

P270	8299330	10	300	11.8	199

► **P262**



► **Hoe** for breaking the ground and loosening clogged soil surfaces
► Helps to prepare the soil before sowing

P262	8299286	10	315	12.4	224

► **P263**



► **Trowel** for all kinds of work like preparation of beds and borders, potting, planting and distributing compost, mulch or fertilizer

P263	8299262	10	370	14.5	306

► **P264**



► **Cultivator** for loosening the soil to let air, heat and water in, thus supporting the development of the root system
► Helps to control weeds by uprooting seedlings

P264	8299279	10	315	12.4	210

► **P266**



► **Rake** for cleaning and levelling the soil around the plants

P266	8299293	10	320	12.6	199

► **P267**



► **Two-point hoe**
► Versatile tool for different jobs
► Hoe blade for loosening the ground and for breaking clogged soil or cutting weeds
► Two-prong fork for loosening the soil to aerate

P267	8299309	10	315	12.4	231

► **P268**



► **One-point hoe** for preparing the soil and sowing or transplanting
► Broad hoe blade for breaking clogged soil and for weeding
► Pointed hoe blade for making rows and furrows for sowing and planting

P268	8299316	10	325	12.8	235



AXES, MAULS AND WEDGES

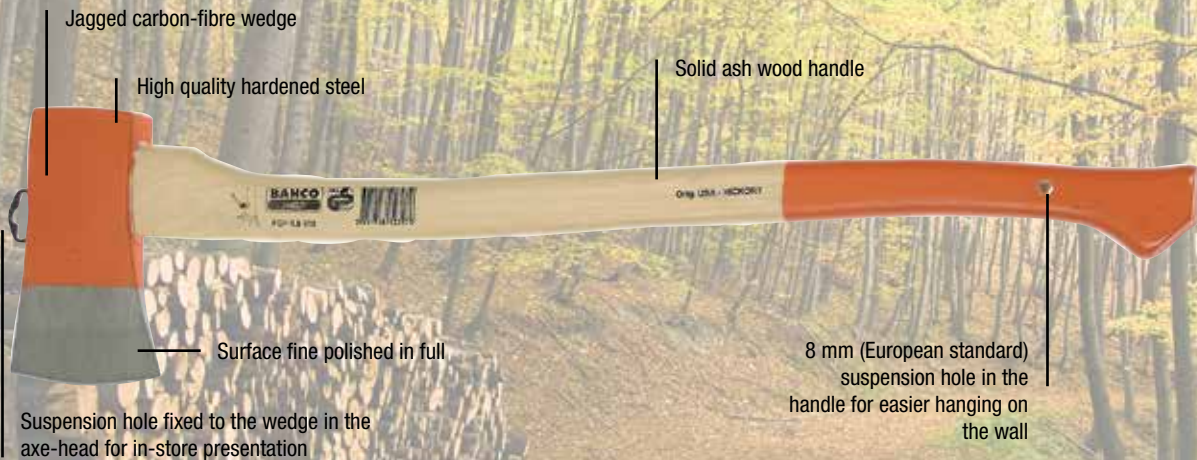

All axes are supplied with a rubber edge protector to ensure the finish of the blade is maintained

All axes are produced according to DIN standards and we use certified wood from sustainably managed forests



ICONOGRAPHY



Camping

- ▶ Camping axes are light weight axes with a short handle which makes them easy to carry around. Also suitable for indoor use e.g. as a kitchen axe
- ▶ Head weight: 0.6 kg / 1 1/4 lb to 1 kg / 2 1/4 lb
- ▶ Length: 36 - 50 cm / 14 1/4" - 19 3/4"



Trimming branches and felling

- ▶ Hatchets are longer axes for trimming trees and other general purpose work
- ▶ Head weight: 1 kg / 2 1/4 lb
- ▶ Length: 60 - 70 cm / 23 1/2" - 27 1/2"



Felling

- ▶ Felling axes are heavier axes with long handles and a thinner edge, for easy cutting when felling trees
- ▶ Head weight: 1.1 kg / 2 1/2 lb to 2.3 kg / 5 lb
- ▶ Length: 70 - 90 cm / 27 1/2" - 35 1/2"



Splitting

- ▶ Splitting axes have a thick head especially made for splitting wood. The shape of the head helps to penetrate into the wood with little effort. Some are made with a longer head back to use with a splitting wedge
- ▶ Head weight: 2 kg / 4 1/2 lb to 3.5 kg / 7 3/4 lb
- ▶ Length: 80 - 90 cm / 31 1/2" - 35 1/2"



Splitting with wedges

- ▶ Mauls are heavy sledge hammers that can be used to drive poles into the ground or splitting wedges into logs
- ▶ Head weight: 3 kg / 6 1/2 lb to 4 kg / 8 3/4 lb
- ▶ Length: 90 cm / 35 1/2"



▶ CAMPING AXES

▶ HUS



- ▶ For general-purpose applications such as camping and gardening work and occasional branch trimming
- ▶ High-quality tool steel according to DIN 7287, class B
- ▶ Curved ash wood handle, according to DIN 5132, form B, secured by a jagged carbon fibre wedge equipped with a euro suspension hole in addition to an 8 mm (European standard) suspension hole in the handle

	mm	mm	mm	mm	kg
HUS-0.6-380	8123659	4	380	15	850
HUS-0.8-500	8123666	4	500	20	1150

▶ HGPS



- ▶ All-round general-purpose axe with a thin wide blade for a clean cut
- ▶ Curved ash wood handle, secured by a jagged carbon-fibre wedge equipped with a euro hole in addition to an 8 mm (European standard) suspension hole in the handle

	mm	mm	mm	mm	kg
HGPS-0.6-360	8123680	4	360	14 1/4	800
HGPS-0.8-380	8123697	4	380	15	1000
HGPS-1.0-400	8123703	4	400	15 3/4	1250

▶ HFGPS



- ▶ Short general purpose axe for lighter applications
- ▶ Backside of the axe head can also be used as hammer
- ▶ Straight three-component handle with non-slip grip (polypropylene handle with elastomer grip and fibreglass core) for comfort, security and longevity

	mm	mm	mm	mm	kg
HFGPS-0,7-400FG	8275877	4	380	15	1070



▶ HATCHETS

▶ HUS



- ▶ For branch trimming and general-purpose gardening work
- ▶ High-quality tool steel according to DIN 7287, class B
- ▶ Curved ash wood handle, according to DIN 5132, form B, secured by a jagged carbon fibre wedge equipped with a euro suspension hole in addition to an 8 mm (European standard) suspension hole in the handle

	mm	mm	mm	mm	kg
HUS-1.0-650	8123673	4	650	26	1400

▶ FGS



- ▶ For branch trimming and felling small trees
- ▶ High-quality tool steel according to DIN 17200, Carbon 45
- ▶ Curved ash-wood handle, secured by a jagged carbon fibre wedge equipped with a euro suspension hole in addition to an 8 mm (European standard) suspension hole in the handle
- ▶ Slightly wider at the eye. The thin, wide blade ensures a clean and easy cut into the branch

	mm	mm	mm	mm	kg
FGS-1.0-600	8123796	4	600	24	1500
FGS-1.25-700	8123802	4	700	28	1800

► FELLING AXES

► FGS



- For felling trees and branch trimming
- High-quality tool steel according to DIN 17200, Carbon 45
- Curved ash-wood handle, secured by a jagged carbon fibre wedge equipped with a euro suspension hole in addition to an 8 mm (European standard) suspension hole in the handle
- Slightly wider at the eye. The thin, wide blade ensures a clean and easy cut into the branch

	ITEM NO.	Weight	Length	Blade Width	Weight
			mm	inch	kg
FGS-1.6-810	8123819	4	800	32	2200
FGS-1.8-810	8123826	4	800	32	2400

► FCP



- For felling trees and cutting off branches from felled trees
- The thin blade makes it swing smoothly through the branch
- High-quality tool steel according to DIN 7287, class B
- Fine-polished surface
- First-grade hickory wood handle, pressed into the eye and fixed with a jagged carbon fibre wedge and an additional metal ring-wedge
- The wedge is equipped with a euro suspension hole and the handle has an 8 mm (European standard) suspension hole

	ITEM NO.	Weight	Length	Blade Width	Weight
			mm	inch	kg
FCP-1.8-810	8123970	4	800	32	2400
FCP-2.3-860	8123994	2	850	34	3000



► FFSS



- Flare-headed felling axe with long, straight handle, which enables a long swing and a deep cut
- Three-component handle (fibreglass core, polypropylene around the core and elastomer grip) for comfort, security and longevity
- Comfortable non-slip grip with large suspension hole

	ITEM NO.	Weight	Length	Blade Width	Weight
			mm	inch	kg
FFSS-1.5-900FG	8275884	4	900	35	2400



► SPLITTING AXES

► SUS-2.0-800



- The wedge-shaped axe head, as well as its weight, provides easier penetration when forcing the wood apart
- Curved ash wood handle equipped with an 8 mm (European standard) suspension hole, secured by a jagged carbon fibre wedge and an additional metal ring-wedge equipped with a euro suspension hole

SUS-2.0-800	8123451	2	800	32	2400

► LS-MERLIN-2.5



- Heavy axe, flat on one side for use both as a splitting axe and a hammer to drive a wedge
- Intended for chopping difficult and very thick wood
- Straight ash wood handle, secured with a leather strap below the head and equipped with an 8 mm (European standard) suspension hole

LS-MERLIN-2.5	8012069	2	900	36	3000

► MES-3.5-900



- Heavy axe for using both as a splitting axe and a hammer to drive a wedge
- Head with turning hook for logs
- Intended for chopping difficult and very thick wood
- Straight ash wood handle secured with a jagged carbon fibre wedge, and an additional metal ring wedge

MES-3.5-900	8123871	2	900	36	3800

► MES-3.0-900



- Heavy axe, flat on one side for use both as a splitting axe and a hammer to drive a wedge
- Intended for chopping difficult and very thick wood
- Straight ash wood handle, secured with a leather strap below the head
- Large suspension hole

MES-3.0-900	8123864	2	900	36	3500

► MCP-2.5-810



- Heavy splitting axe, flat on one side, for using both as a splitting axe and a hammer to drive a wedge
- Intended for chopping difficult and very thick wood
- First-grade hickory wood handle equipped with an 8 mm (European standard) suspension hole for easier hanging on the wall, pressed into the eye and secured with a jagged carbon fibre wedge, and an additional metal ring-wedge

MCP-2.5-810	8124052	2	800	32	3200

► LS-MERLIN-2.5FG



- Heavy axe, flat on one side for use both as a splitting axe and a hammer to drive a wedge
- Intended for chopping difficult and very thick wood
- Three-component handle (fibreglass core, polypropylene around the core and elastomer grip) for comfort, security and longevity
- Comfortable non-slip grip with large suspension hole

LS-MERLIN-2.5FG	8281113	2	900	35	3550

► MES-3.5-900FG



- Heavy axe for using both as a splitting axe and a hammer to drive a wedge
- Head with turning hook for logs
- Intended for chopping difficult and very thick wood
- Three-component handle (fibreglass core, polypropylene around the core and elastomer grip) for comfort, security and longevity
- Comfortable non-slip grip with large suspension hole

MES-3.5-900FG	8281120	2	900	35	3900



▶ MAULS

▶ LS-MASSE-4



- ▶ Maul / sledge for driving poles and for forcing wedges into hard-to-work types of wood
- ▶ Head of high-quality tools steel, flat on both sides
- ▶ Straight ash wood handle equipped with an 8 mm (European standard) suspension hole

LS-MASSE-4	8012014	2	900	35 1/2	4300	

▶ LS-MASSE-4FG



- ▶ Maul / sledge for driving poles and for forcing wedges into hard-to-work types of wood
- ▶ Head of high-quality tools steel, flat on both sides
- ▶ Three-component handle (fibreglass core, polypropylene around the core and elastomer grip) for comfort, security and longevity
- ▶ Comfortable non-slip grip with large suspension hole

LS-MASSE-4FG	8275891	2	900	35	4300	

▶ LS-MASSE-TR-4FG



- ▶ Maul / sledge for driving poles and for forcing wedges into hard-to-work types of wood
- ▶ Head of high-quality tools steel, flat on one side
- ▶ Three-component handle (fibreglass core, polypropylene around the core and elastomer grip) for comfort, security and longevity
- ▶ Comfortable non-slip grip with large suspension hole

LS-MASSE-TR-4FG	8281106	2	900	35	5000	

▶ WEDGES

▶ W-T-2.0



- ▶ Twisted steel wedge for easy splitting of hard-to-work types of wood, requires little force to drive in
- ▶ Excellent splitting capacity

W-T-2.0	8140847	4	220	8 1/2	2000	

▶ W-S



- ▶ Traditional steel wedge to be used together with a sledge hammer or a splitting maul
- ▶ Three weights available

W-S-1.5	8140816	4	230	9	1500	
W-S-2.0	8140823	4	250	10	2000	
W-S-2.5	8140830	4	260	10 1/4	2500	

▶ LS-COIN



- ▶ Synthetic wedge, ideal for use in conjunction with felling operations using a chain saw
- ▶ Does not damage the saw chain

LS-COIN 19 CM	8031077	4	190	7 1/2	260	
LS-COIN 26 CM	8333041	2	260	10 1/4	295	



▶ AXE SAFETY AND CARE

DO NOT use the axes on the side of the trunk where you are standing as there is a risk of slipping and hurting yourself

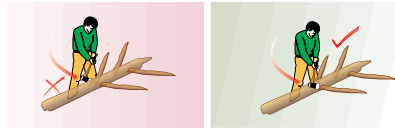

Keep the trunk between you and the branches you intend to remove. Always cut branches from the root towards the top

DO NOT stand erect when splitting wood. It could lead to severe injury if you miss your target



Bend your knees slightly to make sure the axe hits the ground if you should accidentally slip

DO NOT twist the axe sideward if it gets stuck, as this could break or loosen the handle



Work the axe loose by moving it up and down

DO NOT try to force splitting wedges into the wood with a normal axe. This could deform the eye, loosen the handle or even break the head



Use a maul or a sledge hammer, which are both designed for wood splitting

DO NOT use a maul as a wedge. The head of the maul may become deformed or break

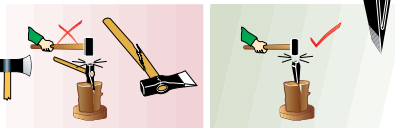

Take a special splitting wedge for this task

DO NOT store axes or mauls in a dry place. Under very low air humidity like in heated rooms the handle could shrink and may no longer fit perfectly into the eye



Storage in an unheated shed, barn or garage is recommended

▶ SPARE HANDLES FOR AXES

Spare handles are available in different materials. The wooden handles are delivered with a fixing wedge and an assembly instruction.

	SH-HGPS-360	7311518140618	1	360	ash wood	HGPS-0.6-360
	SH-HGPS-380	7311518140625	1	380	ash wood	HGPS-0.8-380
	SH-HGPS-400	7311518207618	1	400	ash wood	HGPS-1.0-400
	SH-HFGPS-400FG	7311518282301	1	400	three-component fibreglass	HFGPS-0.7-400FG
	SH-HUS-380	7311518140502	1	380	ash wood	HUS-0.6-380
	SH-HUS-500	7311518140519	1	500	ash wood	HUS-0.8-500
	SH-HUS-650	7311518140526	1	650	ash wood	HUS-1.0-650
	SH-FGS-600	7311518140649	1	600	ash wood	FGS-1.0-600
	SH-FGS-700	7311518140656	1	700	ash wood	FGS-1.25-700
	SH-FGS-800	7311518140663	1	800	ash wood	FGS-1.6-600
	SH-FCP-860	7311518324421	1	860	hickory wood	FCP-2.3-860, FCP-2.0-860
	SH-FCS-810	7311518140540	1	810	ash wood	FCP-1.4-810, FCP-1.8-810
	SH-FGS-1.8-810	7311518327828	1	900	ash wood	FGS-1.8-810
	SH-FCS-860	7311518140557	1	860	ash wood	FCP-2.3-860, FCP-2.0-860
	SH-SUS-800	7311518140809	1	800	ash wood	SUS-2.0-800
	SH-MCS-800	7311518140595	1	800	ash wood	MCP-2.5-810
	SH-MES-900	7311518140601	1	900	ash wood	MES-3.5-900
	SH-MES-F-900	7311518141554	1	900	ash wood	LS-MASSE-4, LS-MERLIN-2.5, MES-3.0-900
SH-MES-900FG	7311518282318	1	900	three-component fibreglass	MES-3.5-900FG, FFSS-1.5-900FG, LS-MERLIN-2.5FG, LS-MASSE-4FG, LS-MASSE-TR-4FG	

FILES

▶ 168-1P



- ▶ Round chain saw file for sharpening the cutting tooth of the saw chain
- ▶ Each file is packed in a skin pack which can be reused as a protective sleeve

			mm.	inch	mm.	inch	
168-6-3.2-1P	8152338	12	150	6	3.2	1/8	13
168-6-3.5-1P	8152345	12	150	6	3.5	9/64	15
168-8-4.0-1P	8152352	12	200	8	4.0	5/32	23
168-8-4.5-1P	8152369	12	200	8	4.5	11/64	27
168-8-4.8-1P	8152376	12	200	8	4.8	3/1	31
168-8-5.2-1P	8152383	12	200	8	5.2	13/64	36
168-8-5.5-1P	8152390	12	200	8	5.5	7/32	39
168-8-6.3-1P	8152406	12	200	8	6.3	1/4	51

▶ 168-3P



- ▶ Round chain saw file for sharpening of the cutting tooth of the saw chain
- ▶ The files are packed in a three piece protective skin pack with perforations for easy separation
- ▶ 12 Three-packs (36 files) are packed in a combined display / storage box

			mm.	inch	mm.	inch	
168-6-3.2-3P	8152413	12	150	6	3.2	1/8	39
168-6-3.5-3P	8152420	12	150	6	3.5	9/64	45
168-8-4.0-3P	8152437	12	200	8	4.0	5/32	69
168-8-4.5-3P	8152444	12	200	8	4.5	11/64	81
168-8-4.8-3P	8152451	12	200	8	4.8	3/1	93
168-8-5.2-3P	8152468	12	200	8	5.2	13/64	108
168-8-5.5-3P	8152475	12	200	8	5.5	7/32	117
168-8-6.3-3P	8152482	12	200	8	6.3	1/4	153

▶ 168-6

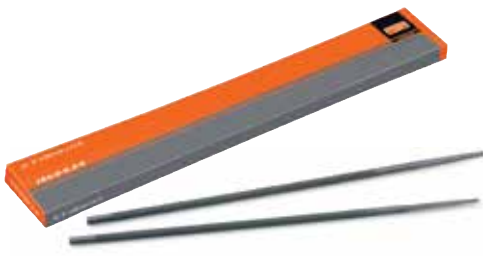

- ▶ Round chain saw file for sharpening the tooth of the saw chain
- ▶ 10 six packs (60 files) are packed in a combined display / storage box

			mm.	inch	mm.	inch	
168-8-4.0-6	8217419	6	200	8	4.0	5/32	23
168-8-4.5-6	8217426	6	200	8	4.5	11/64	27
168-8-4.8-6	8217433	6	200	8	4.8	3/16	31
168-8-5.2-6	8217440	6	200	8	5.2	13/64	36
168-8-5.5-6	8217457	6	200	8	5.5	7/32	39

▶ 168-C



- ▶ Combination packaging with two round chain saws files
- ▶ One file is fitted with a comfortable ERGO™ handle
- ▶ The packaging also includes a 6" flat chain saw file

			mm.	inch	mm.	inch	
168-COMBI-4.0	8209667	1	200	8	4.0	5/32	150
168-COMBI-4.8	8209674	1	200	8	4.8	3/16	160
168-COMBI-5.5	8209681	1	200	8	5.5	7/32	175

▶ 168-C-G



- ▶ Combination packaging of two round chain saws files
- ▶ One file is fitted with a comfortable ERGO™ handle
- ▶ The packaging also includes 6" flat chain saw file
- ▶ Filing guide included to guarantee the best filing result both with the round and the flat chain saw file

			mm.	inch	mm.	inch	
168-COMBI-4.0-6922	8209612	1	200	8	4.0	5/32	185
168-COMBI-4.8-6920	8209643	1	200	8	4.8	3/16	195
168-COMBI-5.5-6924	8209650	1	200	8	5.5	7/32	210



▶ **166-2** ergo®



- ▶ Parallel flat file with round uncut edges for filing depth gauges on saw chains and for sharpening brush cutter blades
- ▶ Packed individually with a comfortable ERGO™ handle

				A mm/inch	B mm/inch	C mm/inch	
166-6-16-2.5-2	8209698	5		150 / 6	16.0 / 5/8	2.5 / 3/32	105

▶ **166/167-12**



- ▶ Parallel flat file with round uncut edges
- ▶ For filing of depth gauges on saw chains and for sharpening of brush cutter blades
- ▶ 12-pack bulk, industrial pack

				A mm/inch	B mm/inch	C mm/inch	
167-8-21-3.2-12	8021986	12		200 / 8	21.0 / 53/64	3.2 / 1/8	94
166-6-16-2.5-12	8021979	12		150 / 6	16.0 / 5/8	2.5 / 3/32	48

▶ **4-153** ergo®



- ▶ Use:
 - ▶ Double cut: rough sharpening of edges on spades, hoes, mower blades, axes, etc
 - ▶ Single cut: fine sharpening of edges on above implements and on knives and scissors, etc
- ▶ Shape: Flat, parallel, with two flat, uncut edges
- ▶ One side bastard double cut, the other side single cut
- ▶ Packed individually with a comfortable ERGO™ handle

				A mm/inch	B mm/inch	C mm/inch	
4-153-08-1-2	8000707	5		200 / 8	25 / 63/64	4 / 5/32	195

▶ **4-272** ergo®



- ▶ Double edge chain saw file "wasa®"
- ▶ Use:
 - ▶ For sharpening saws with straight, fine toothing
- ▶ Shape: Parallel, double conical. Surfaces and edges single cut
- ▶ Teeth pointed towards the tip of the file
- ▶ Packed individually with a comfortable ERGO™ handle

				A mm/inch	B mm/inch	C mm/inch	
4-272-05-3-2	8201500	5		125 / 5	16.0 / 5/8	4.0 / 5/32	100
4-272-06-3-2	8001025	5		150 / 6	16.0 / 5/8	4.0 / 5/32	105

▶ **SPARE HANDLES FOR FILES**

▶ **9-486-C** ergo®



- ▶ Ergonomically designed, two component plastic handle with a hard, polypropylene core and a layer of thermoplastic elastomer to provide a soft, textured surface for an excellent grip
- ▶ The handle can hold both round chain saw files (type 168) and the flat chain saw file (type 166)
- ▶ 9-486-C-1P: single pack carded
- ▶ 9-486-C-10: 10-pack bulk

9-486-C-1P	8209605			50
9-486-C-10	8209599			45

▶ **PH-6604**



- ▶ Handle for 8" round chain saw files with three integrated angle guides
- ▶ PH-6604-1P: single pack carded
- ▶ PH-6604-25: 25-pack bulk

PH-6604-1P	8152819			55
PH-6604-25	8141134			50

▶ MAINTENANCE AND ACCESSORIES

▶ GRINDING STONES

▶ LS-COMBINESS



- ▶ Synthetic two-component grinding stone for small blades
- ▶ To be moistened with petrol or oil for full efficiency
- ▶ Quick removal of damaged metal surfaces with 180 grain/cm² (green side of stone)
- ▶ Smooth finish with 400 grain/cm² (grey side)

LS-COMBINESS	8041366	1	100 mm.	4 inch	75

▶ LS-NATURAL



- ▶ High quality natural grinding stone, grain size 600
- ▶ For finishing edges of pruning tools
- ▶ To be used in a wet state in order to sharpen more efficiently
- ▶ Especially recommended for small blades requiring to be sharpened precisely

LS-NATURAL	8224622	1	70 mm.	2 3/4 inch	40

▶ LS-TRIANGLE



- ▶ Synthetic grinding stone, grain size 220
- ▶ To sharpen blades with high precision
- ▶ Stone can either be moistened with petrol, oil or water

LS-TRIANGLE	8224653	1	100 mm.	4 inch	50

▶ LS-PIERRE CORINDON



- ▶ Synthetic grinding stone, grain size 320
- ▶ For professional use to sharpen high performance small blades like on secateurs
- ▶ Very high removal rate
- ▶ To be moistened with petrol or oil for full efficiency

LS-PIERRE CORINDON	8009977	30	100 mm.	4 inch	50

▶ LS-PIERRE-FAUX



- ▶ Synthetic grinding stone, grain size 180
- ▶ To be sharpen long blades for tough work such as long shafted tools, scythes and axes
- ▶ To be moistened with petrol or oil for full efficiency

LS-PIERRE-FAUX	8009038	1	230 mm.	9 inch	210

▶ SHARP-X



- ▶ Professional tungsten-carbide sharpener to re-sharpen all kind of blades
- ▶ Two-component handle for comfortable use
- ▶ Very secure with two side protections to avoid fingers slipping down to the cutting edge of the blade
- ▶ Two carbide edges for easy and long-lasting use
- ▶ SHARP-X-DISP: display of 30 pcs

SHARP-X	8264895	10	100 mm.	4 inch	25
SHARP-X-DISP	8264901	30	100 mm.	4 inch	25

▶ LS-6160-23



- ▶ Synthetic grinding stone, "Carbor" type, grain size 220
- ▶ Produces very fine surfaces on cutting tools
- ▶ Can be used wet or dry
- ▶ Not recommended for finishing work on small or new blades

LS-6160-23	8041304	1	230 mm.	9 inch	170

▶ CLEANERS AND LUBRICANT

▶ SAP-X



- ▶ Cleaning fluid for pruning blades
- ▶ Removes dirt and stains and is a corrosion inhibitor
- ▶ To be sprayed on the surface of the blade and after a while wipe clean

SAP-X	8225728	6	75

▶ ECO-LUBE100



- ▶ Natural lubricant for secateurs
- ▶ To keep the tools in good shape reducing parts friction and allowing a smoother cutting action
- ▶ To apply on bolts and junctures

ECO-LUBE100	8249434	4	128



► MAINTENANCE TIPS

Regular maintenance will keep the cutting edges of your Bahco pruning tools razor sharp. Cleaning and oiling will keep their actions smooth and fast. A sharp blade reduces workload and makes fast-healing clean cuts. To maintain a keen edge performance, maintenance at regular intervals is required. Four steps to maintain your pruning tool:

- 1 & 2 : Clean the blades with SAP-X cleaning fluid
- 3 : Sharpen the blades with a stone or a carbide sharpener
 - Do 10 strokes at a 30° angle starting at the base of the cutting edge and working toward the tip
 - Remove burrs with one light stroke along the back side. Keep the stone flat
- 4 : Lubricate the blades with ECO-LUBE100 lubricant

► SECATEURS

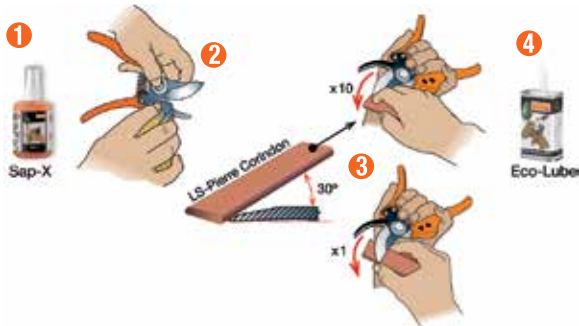

► LOPPERS

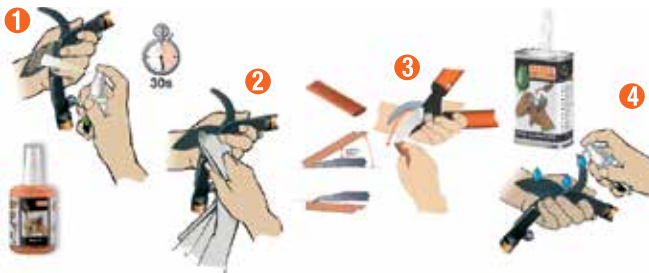

► HEDGE SHEARS



► PRUNING SAWS

The Bahco 4-272-06-3-2 Ergo™ saw file has been especially designed for sharpening saw teeth of fileable blades.

Clamp the saw blade, teeth up in a bench vice. Hold the file firmly in one hand and steady it by holding the tip with the other.



Always hold the file horizontal in a position which feels comfortable.

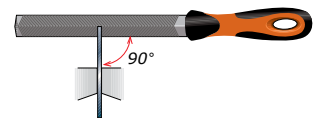

Angle the file by moving your entire body and not just the file.

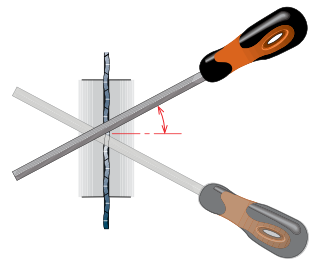

If you are filing in a comfortable and stress free position, the angle will tend to remain constant.

Apply 2-3 light-to-medium pressure strokes per tooth. First, file one side of the teeth over the length of the blade (move the blade in the vice to dampen vibrations). Then, change your body position to angle the file for the other side of the teeth and repeat along the blade length. Turn the blade in the vice and repeat for the other side.

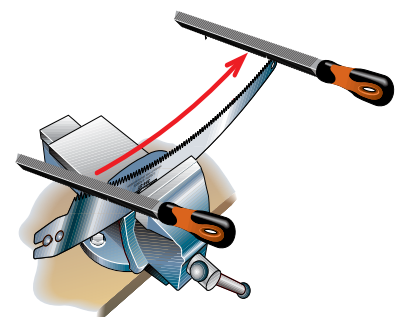

▶ HOLSTERS

▶ PROF-H



- ▶ Strong and natural-coloured leather holster for secateurs
- ▶ Two belt slits to fit any belt up to 50 mm width
- ▶ Top-quality leather, studded and stitched
- ▶ Steel belt clip feature

PROF-H	8158439	2	86

▶ 4750-2PP-1



- ▶ Two pocket fixings pouch
- ▶ Extra strong 600D polyester
- ▶ Leather sleeve for your knife
- ▶ Handy extra pocket

4750-2PP-1	*3014733	1	240x120x290
EAN code (*) 731415+			
			360

▶ PROF-SEC



- ▶ Practical secateur holster for any pruning activity
- ▶ Wear-resistant and light weight nylon material for durability and comfort
- ▶ Equipped with additional pocket for grinding stone or grafting knife and belt loop (fits 4750-QRLB-1 & 4550-HDB-1)

PROF-SEC	8288532	1	150



▶ 4750-KNHO-0



- ▶ Knife holder made out of suede leather
- ▶ Riveted for truly unbreakable strength

4750-KNHO-0	*0289462	1	200x100x50
EAN code (*) 731415+			
			90

▶ 4750-HDB-2



- ▶ Heavy duty leather belt with stainless steel twin-pin buckle
- ▶ Riveted for truly unbreakable strength

4750-HDB-2	*0289486	1	900x190x50
EAN code (*) 731415+			
			650

▶ 4750-KNHO-1



- ▶ Knife holder
- ▶ Riveted reinforcement
- ▶ Rust proofed fittings

4750-KNHO-1	*3015839	1	90x30x160
EAN code (*) 731415+			
			63



▶ HOLSTERS AND GLOVES

▶ PROF-LOPP

- ▶ Practical lopper holster primarily for pruning in vineyards
- ▶ Additional pocket to carry a sharpening stone, grafting knife or a sharp-X
- ▶ Holster can be strapped to the lower part of the leg or in a belt
- ▶ Made of wear-resistant and light weight nylon material for durability and comfort
- ▶ Holster fits loppers P116, P114, P16 up to 60 cm length



PROF-LOPP	8288549	1	375

▶ 4750-MPH-1

- ▶ Multi purpose holder
- ▶ Measuring tape clip for all kind of measuring tapes
- ▶ Riveted for truly unbreakable strength
- ▶ Extra leather slot for pen or small screwdriver



4750-MPH-1 EAN code (*) 731415+	*0291625	1	220

▶ GL008

- ▶ A thin PU material gives user better touch and feel
- ▶ Absorption pad on thumb



GL008-10 GL008-8 EAN code (*) 731415+	*0167050 *0167043	6 6	10 8	72 69

▶ GL010

- ▶ Anti-vibration pads on fingers and palms
- ▶ Reflective strip across the back
- ▶ Absorption patch on the thumb



GL010-10 GL010-8 EAN code (*) 731415+	*0167098 *0167081	6 6	10 8	140 137



▶ GL012

- ▶ Reinforced grip pads on fingers and palm
- ▶ Missing ends on thumb, index and middle fingers
- ▶ Absorption pad on thumb



GL012-10 GL012-8 EAN code (*) 731415+	*0167104 *0167111	6 6	10 8	91 87



▶ LANYARDS

▶ 3875-LY1



- ▶ Max 3 kg tool weight (3daN)
- ▶ Length 80 cm, fully extended 120 cm
- ▶ Non-removable carabiners
- ▶ High strength webbing and self-retracting inner coil jointly absorbs shock
- ▶ High tenacity polyester
- ▶ Individual tracking number

3875-LY1	*0191253	8	170
EAN code (*) 731415+			

▶ 3875-LY2



- ▶ Max 3 kg tool weight (3 daN)
- ▶ Length 80 cm, fully extended 120 cm
- ▶ One non-removable carabiner and one fixed loop with barrel lock
- ▶ High strength webbing and self-retracting inner coil jointly absorbs shock
- ▶ High tenacity polyester
- ▶ Individual tracking number

3875-LY2	*0191260	8	115
EAN code (*) 731415+			

▶ 3875-LY3



- ▶ Max 1 kg tool weight (1 daN)
- ▶ Length 65 cm, fully extended 120 cm
- ▶ One non-removable carabiner and one exchangeable loop with barrel lock
- ▶ High strength webbing and self-retracting inner coil jointly absorbs shock
- ▶ High tenacity polyester
- ▶ Individual tracking number

3875-LY3	*0191284	8	125
EAN code (*) 731415+			

▶ 3875-RL1



- ▶ Max 0,9 kg tool weight (0,9 daN)
- ▶ Length fully extended 100 cm
- ▶ Non-removable carabiner
- ▶ One exchangeable loop with barrel lock
- ▶ Polycarbonate case and spectra line
- ▶ Lock button on the side

3875-RL1	*0194780	1	200
EAN code (*) 731415+			

▶ 3875-WL1



- ▶ Max 1 kg tool weight (1 daN)
- ▶ Length 60 cm
- ▶ Wrist attachment with barrel lock
- ▶ Exchangeable loop with barrel lock
- ▶ High strength webbing absorbs shock
- ▶ High tenacity polyester
- ▶ Individual tracking number

3875-WL1	*0191291	8	40
EAN code (*) 731415+			

▶ 439000000



- ▶ Used for construction wrench
- ▶ Steel wire coated with PVC
- ▶ Fully extended length 200 cm
- ▶ Non-removable carabiners
- ▶ Additional ring and string to holding of tools 1 mm diameter
- ▶ Maximum weight recommended: 10 kg

439000000	*5129282	1	100
EAN code (*) 841334+			

▶ 439000001



- ▶ Used for construction wrench
- ▶ Steel wire coated with PVC
- ▶ Fully extended length 150 cm
- ▶ Non-removable carabiners
- ▶ Additional ring and string to holding of tools 1,7 mm diameter
- ▶ Maximum weight recommended: 20 kg

439000001	*0268788	1	130
EAN code (*) 731415+			



HAND TOOLS

8224

ergo®



- ▶ Slip joint pliers developed according to the scientific ERGO™ process
- ▶ ISO 8976
- ▶ Finish: Black finish, anti-corrosion treated
- ▶ Material: High performance alloy steel
- ▶ ERGO™ handles in 2-component combination, thermoplastic surface, for comfortable grip, on tough polypropylene core for rigidity
- ▶ Hardened jaws, Teeth designed to ensure grip, Jaws for flat and pipe shape gripping
- ▶ Single thumb button adjustment
- ▶ IP: Industrial Packed

	ISO 8976	5	A mm	B mm	C mm	D mm	E mm	F mm	Piano mm	Scale
8224	*0000012	5	250	40	51	8.0	6	8.0	45	350
8224IP	*0101757	5	25	40	51	8.0	6	8.0	45	350

EAN code (*) 731415+

2339 D

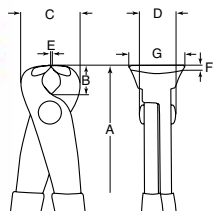

- ▶ Finish: Black epoxy powder coated, anti-corrosion treated
- ▶ Material: High performance alloy steel, PVC coated handles for better gripping comfort
- ▶ With high leverage design for ease to use
- ▶ For wire twisting and cutting at construction sites (armouring) and to cut medium hard wire used in this application
- ▶ IP = Industrial Packed

	ISO 8976	5	A mm	B mm	C mm	D mm	E mm	F mm	G mm	Piano mm	Scale
2339 D	*0032792	3	220	16	28	21	1.0	3.0	21	2.5	320
2339 DIP	*0103508	5	220	16	28	22	1.0	3.0	22	2.5	320

EAN code (*) 731415+

9571



- ▶ Adjustable wrench with side nut operating system
- ▶ Standards: ISO 6787, DIN 3117, BS 6333, ASME B107.8M – 2003 and UNE 16532
- ▶ Smooth movement and precision tuning
- ▶ Head angle 15° provides better accessibility
- ▶ Comfortable non slip thermoplastic grip handle

	ISO 8976	5	A mm	B mm	C mm	D mm	Scale
9571	*0178582	5	208	27	7.5	14	300

EAN code (*) 731415+

484-1250

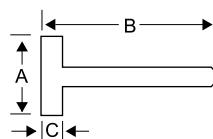

- ▶ Club hammer with convex (domed) striking faces
- ▶ Handle of first class genuine hickory, straight grained, without knots
- ▶ DIN 6475, GS certification

	ISO 8976	4	A mm	B mm	C mm	L mm	Scale
484-1250	8005139	4	107	260	42	1250	1330

8224CIP

ergo®



- ▶ Slip joint pliers developed according to the scientific ERGO™ process
- ▶ ISO 8976
- ▶ Finish: Chrome plated, anti-corrosion treated
- ▶ Material: High performance alloy steel
- ▶ ERGO™ handles in 2-component combination, thermoplastic surface, for comfortable grip, on tough polypropylene core for rigidity
- ▶ Hardened jaws, Teeth designed to ensure grip, Jaws for flat and pipe shape gripping
- ▶ Single thumb button adjustment
- ▶ Industrial packed

	ISO 8976	5	A mm	B mm	C mm	D mm	E mm	F mm	Piano mm	Scale
8224CIP	*0103607	5	250	40	51	8.0	6	8.0	45	350

EAN code (*) 731415+

1520 D

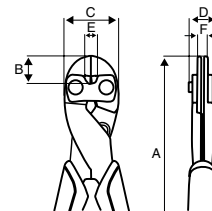

- ▶ Power cutter with centric precision cutting edges
- ▶ Finish: Black finish anti-corrosion treated
- ▶ Material: High performance alloy steel, PVC coated handles
- ▶ Forged with cutting edges for piano, hard and soft wire
- ▶ High leverage giving exceptional cutting performance with minimum effort
- ▶ The precision cutting edges are additionally induction hardened 63-64 HRC

	ISO 8976	5	A mm	B mm	C mm	D mm	E mm	F mm	Piano mm	Scale
1520 D	8278922	5	205	16	33.5	17.1	8	6	3.8	300

485

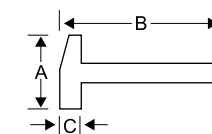

- ▶ Carpenter's hammer with anti-slip striking face and magnetic nail holder
- ▶ Tubular steel shaft with comfortable grip
- ▶ DIN 7239, GS certification

	ISO 8976	4	A mm	B mm	C mm	L mm	Scale
485	8005153	4	170	308	26	600	925

3625RM-75

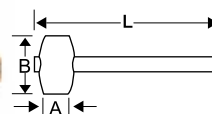

- ▶ Rubber mallet
- ▶ Wooden handle

	ISO 8976	6	A mm	B mm	L mm	Scale
3625RM-75	*3019820	6	75	125	360	600

EAN code (*) 731415+

▶ **466-800**



- ▶ Box section anodized finish aluminium level
- ▶ Shock absorbing end caps
- ▶ Permanent precision +/- 0.5 mm per metre
- ▶ Machined surfaces and "V" groove base
- ▶ Thick shaped profile
- ▶ Large vials for ease of view
- ▶ Laser marked measuring scale (for indication purposes only)

466-800	*0128310	4	800	1	2
EAN code (*) 731415+					

▶ **9574-200**



- ▶ For transferring a measured angle to a work piece for cutting or machining
- ▶ The blade can be tightened with the wing screw at the end, this also doubles as a hanging hole in storage

9574-200	*0138197	10	200	165
EAN code (*) 731415+				

▶ **MW-250**



- ▶ Measuring wheel
- ▶ 250 mm diameter rubber coated measuring wheel
- ▶ Adjustable handle height
- ▶ Fold down kickstand
- ▶ Measures up to 9999.9 m
- ▶ Push button reset

MW-250	0125678	2	250	1334
EAN code (*) 731415+				

▶ **BE-8675**



- ▶ Set of long black finish offset screwdrivers for TORX® and TORX® tamper resistant head screws, 8 pcs
- ▶ 2-component compact holder enables easy removal of individual keys
- ▶ Content: TR-9 TR-10 TR-15 TR-20 TR-25 TR-27 TR-30 TR-40
- ▶ All sizes marked on the holder for easy selection
- ▶ Hanging hole

BE-8675	0123872	1	180
EAN code (*) 731415+			

▶ **308506000**



- ▶ Construction square for layout and setting up

			A mm	B mm	C mm	D mm	
308506000	*5035163	1	600	300	30	30	1020
EAN code (*) 841334+							

▶ **2303H0000**



- ▶ Forged in one piece
- ▶ Tempered
- ▶ Madrid model

2303H0000	5091466	6	190x103	318
EAN code (*) 841334+				

▶ **MTS-5-25**



- ▶ Tapes are Class II
- ▶ Stainless steel blade with rust resistance coating
- ▶ Easy to read nylon coated blade with reverse blade printing
- ▶ Automatic blade lock
- ▶ Magnetic tip

MTS-5-25	0119233	6	5	300
EAN code (*) 731415+				

▶ **BE-9770**



- ▶ Set of long ball end black finish hexagon offset screwdrivers, metric
- ▶ Content: 1.5 2 2.5 3 4 5 6 8 10 mm
- ▶ In plastic holder
- ▶ All sizes branded onto the lid for an easy selection
- ▶ Hanging hole

BE-9770	0027712	3	355
EAN code (*) 731415+			

▶ BLTS6I

- ▶ 6 SMD LED Lamp
- ▶ 1 SMD LED Torch
- ▶ Impact resistant
- ▶ Pressure resistant
- ▶ Strong and durable
- ▶ IP68
- ▶ 200 Lumens
- ▶ 90° light diffusion angle
- ▶ 3,5 hours running time
- ▶ 3 hour charging time
- ▶ 2100 mAh Li-ion battery



BLTS6I	*0246458	15	280x55x45	380
EAN code (*) 731415+				

▶ BLTS7P

- ▶ Extra thin, ultra light
- ▶ 7 SMD LED lamp
- ▶ 1 SMD LED Torch
- ▶ Magnet included
- ▶ Mini-USB charger
- ▶ IP20
- ▶ 45 lumens
- ▶ 4 hours running time
- ▶ 90° light diffusion angle
- ▶ 3 hours charging time
- ▶ 750mAh Li-ion battery



BLTS7P	*0246410	5	170x23x26	160
EAN code (*) 731415+				

▶ BE-9881 ergo®

- ▶ ERGO™ screwdriver set, 6 pieces
- ▶ For Slotted and Phillips head screws
- ▶ In cardboard box



BE-9881	*0043279	1	450
BE-8020, BE-8040 0.5x3x60, 0.8x4x100			
BE-8150, BE-8155 1.0x5.5x100, 1.2x6.5x125			
BE-8610, BE-8620 PH1x75, PH2x100			
EAN code (*) 731415+			

▶ LA010

- ▶ Full aluminium body
- ▶ Flex neck: the neck features 360° rotation and flexion in every direction
- ▶ Super bright Led with power output: 30 lumens
- ▶ Runtime 6 hours
- ▶ ON/OFF switch
- ▶ Powered by 2 pcs AA battery (battery included)



LA010	*0125821	12	26x345x171	630
EAN code (*) 731415+				

▶ BLTFC1

- ▶ Compact and light lamp with Alu
- ▶ 1 COB LED lamp
- ▶ 1 SMD LED Torch
- ▶ Magnet on base
- ▶ Hook on head
- ▶ Flex handle
- ▶ Mini-USB charger
- ▶ IP20
- ▶ 180-220 lumens
- ▶ 2-3 hours operating time
- ▶ 120° light diffusion angle
- ▶ 2-3 hours charging time
- ▶ 2000 mAh Li-ion battery



BLTFC1	*0246434	20	270x37x50	210
EAN code (*) 731415+				

▶ 808050P

- ▶ Pistol handle ratcheting bit holder screwdriver 1/4"
- ▶ Handle: 3-component handle with textured finish for maximum torque and minimum effort
- ▶ Handle swivels and locks at 30° position for application of higher torque when necessary. This is especially important in work areas where there is little room to twist the screwdriver and the user's hand
- ▶ Locks at 180° for normal operation
- ▶ Interchangeable bit storage compartment with release button for quick access
- ▶ Slide tray that keeps 6 different bits handy and secure: PH 1, PH 2, PZ 1, PZ 2, slotted 4,5 and 5,5
- ▶ Magnetic blade secures bit in screwdriver and makes bit changing easy
- ▶ Knurled blade makes the grip firm providing finger tip control for faster turning (rapid action)
- ▶ Smooth ratcheting stroke, allowing three position ratchet mechanism: forward, reverse and neutral



808050P	*0128105	50	1/4	135	260
EAN code (*) 731415+					

▶ **SL25L**

- ▶ High performance alloy steel
- ▶ Matt finish
- ▶ ISO 1174
- ▶ DIN 3120
- ▶ Case: ABS, 195x45x130 mm
- ▶ Contents, 37 pcs



SL25L	*0256570	10	195x45x130	950
EAN code (*) 731415+				

▶ **S530T**

- ▶ Pass-through socket set
- ▶ Finish: Matt chrome plated
- ▶ Material: High performance alloy steel
- ▶ Case: High Density Polythene (HDPE)
- ▶ Contents, 53 pcs



S530T	*0169122	4	375x215x100	4500
EAN code (*) 731415+				

▶ **S910**

- ▶ 1/4" and 1/2" sockets, and combination spanners set
- ▶ High performance alloy steel
- ▶ Matt finish
- ▶ ISO 1174
- ▶ DIN 3120
- ▶ Case: High Density Polythene (HDPE)
- ▶ Contents, 92 pcs



S910	*0104000	2	375x320x110	6880
EAN code (*) 731415+				

▶ **S410**

- ▶ 1/4" and 1/2" socket set
- ▶ High performance alloy steel
- ▶ Matt finish
- ▶ ISO 1174
- ▶ DIN 3120
- ▶ Case: High Density Polythene (HDPE)
- ▶ Contents, 41 pcs



S410	*3019370	2	375x320x110	2040
EAN code (*) 731415+				

▶ **S240**

- ▶ 1/2" socket set
- ▶ High performance alloy steel
- ▶ Matt finish
- ▶ ISO 1174
- ▶ DIN 3120
- ▶ Case: High Density Polythene (HDPE)
- ▶ Contents, 24 pcs



S240	*0104017	4	375x215x100	4710
EAN code (*) 731415+				

▶ **SLX 17**

- ▶ 3/4" socket set
- ▶ High performance alloy steel
- ▶ Matt finish
- ▶ ISO 1174
- ▶ DIN 3120
- ▶ Case: High Density Polythene (HDPE)
- ▶ Contents, 17 pcs



SLX 17	*3015785	1	105x430x370	12838
EAN code (*) 731415+				

▶ **59S/31-1**

- ▶ 31 pcs bit set: 30 bits and 1 magnetic quick release bit holder
- ▶ In cardboard packaging
- ▶ Drive: 1/4" DIN 3126-C6.3, ISO 1173
- ▶ Finish: Zinc phosphate
- ▶ Material: High performance alloy steel



59S/31-1	*0191451	12	110x65x62	250
EAN code (*) 731415+				

▶ **7823**

- ▶ Impact driver set with 23 pcs in black metal box



7823	*0218141	16	197x70x45	1280
EAN code (*) 731415+				



▶ MTT151



- ▶ Heavy duty aluminium body
- ▶ Anodized finish in orange
- ▶ 18 versatile functions
- ▶ Rust resistant stainless steel blades
- ▶ Hard durable canvas storage pouch with belt loop



MTT151 *0120703 6 150 5.8 320
 EAN code (*) 731415+

▶ MTT051



- ▶ Heavy duty aluminium body
- ▶ 12 versatile functions
- ▶ Rust resistant stainless steel blades
- ▶ Very light tool and heavy duty use



MTT051 *0270521 6 165 6 1/2 315
 EAN code (*) 731415+

▶ SQZ150003



- ▶ Squeeze knife with quick change blade feature
- ▶ 6 spare blades stored in a special compartment



SQZ150003 *3013477 6 350
 EAN code (*) 731415+

▶ SQZ150003-HSBL



- ▶ Hooked utility knife blades
- ▶ Safe plastic dispenser containing 12 blades



SQZ150003-HSBL *3015389 1 51 2.1 100
 EAN code (*) 731415+



Should you need more hand tools, please go on our website www.bahco.com

▶ TOOL STORAGE

▶ 960100030



- ▶ 3 compartments
- ▶ Complete with locking capability

960100030	*5031097	1	500x210x190	4100
EAN code (*) 841334+				

▶ 3100TB



- ▶ Open top tool bag for easy access and use
- ▶ Comfortable padded carry strap and handle
- ▶ 10 internal, 11 external pockets, tape measure clip and spirit level straps
- ▶ Waterproof base

3100TB	*0125364	1	600x400x400	1200
EAN code (*) 731415+				

▶ 1470K5



- ▶ 5 drawer trolley
- ▶ Large capacity heavy duty construction trolley
- ▶ Double wall frame protects the slides and drawers from shocks/crashes
- ▶ Reinforced areas to reduce stress in specific points of the trolley
- ▶ Long ball bearing slides with 100% opening drawers
- ▶ Click/detent closing system of drawers
- ▶ Strong and secure round type key and central locking mechanism
- ▶ Wheels of 125 x 30 mm with ball bearings and non-marking rubber outsurface
 - 2 fixed
 - 2 swivel with brake
- ▶ Drawers internal dimensions:
 - (1 x) 543 x 445 x 53 mm
 - (2 x) 543 x 445 x 118 mm
 - (2 x) 543 x 445 x 184 mm

1470K5	*0136162	1	677x501x950	600	543x445xh	30	30x125 62
EAN code (*) 731415+							

PSP
PJJ
PAW
PSV

1470K Series
Standard colours

▶ 1475K8



- ▶ 8 drawer trolley
- ▶ Lock & Go! latching system prevents drawers' opening when moving the trolley
- ▶ Long ball bearing slides with 100% opening drawers
- ▶ Scratch resistant paint
- ▶ Available in different colours
- ▶ Big capacity heavy duty construction trolley
- ▶ Double wall frame protects the slides and drawers from shocks/crashes
- ▶ Reinforced areas to reduce stress in specific points of the trolley
- ▶ Strong and secure round type key and central locking mechanism
- ▶ Wheels of 125 x 50 mm with ball bearings and non-marking rubber surface
 - 2 fixed
 - 2 swivel with brake
- ▶ Drawers internal dimensions:
 - (6 x) 543 x 445 x 53 mm
 - (1 x) 543 x 445 x 118 mm
 - (1 x) 543 x 445 x 184 mm

1475K8PC	*0182923	2	677x501x955	1100	543x445xh	45	50x125 80
1475K8PCM	*0182930	2	677x501x955	1100	543x445xh	45	50x125 80
1475K8PDG	*0183302	2	677x501x955	1100	543x445xh	45	50x125 80
1475K8PEV	*0182947	2	677x501x955	1100	543x445xh	45	50x125 80
1475K8PSP	*0183357	2	677x501x955	1100	543x445xh	45	50x125 80
1475K8PJJ	*0182961	2	677x501x955	1100	543x445xh	45	50x125 80
1475K8PAW	*0182978	2	677x501x955	1100	543x445xh	45	50x125 80
1475K8PSV	*0186952	1	677x501x955	1100	543x445xh	45	50x125 80
EAN code (*) 731415+							

PSP
PJJ
PAW
PSV

PC
PCM
PDG
PEV

1475K Series
Standard colours



► HYDRAULIC AND LIFTING EQUIPMENT

► BH5DP1000QA

- Used in pits and underneath elevated vehicles for removing, installing or transporting transmissions safely
- Quick approach feature with only 36 strokes to reach full height thanks to the 2 speed pump
- Saddle can be positioned upside down and thanks to the addition of our standard rubber and steel saddles BH11500-04 & BH11500-05 (options)
- Sturdy swivel steel wheels (75mm) covered by PU (2 with brake) for more durability, optimum and manoeuvrability
- Lowering mechanism thanks to a foot pedal allowing the user to keep his hands free for other operations
- Certified according to 2006/42/EC + BS EN1494



Icon	HESS 731151+	Icon	Icon	Icon	Icon	Icon	Icon
BH5DP1000QA	*0270224	1	1444x759	1389	1899	1000	80
EAN code (*) 731415+							

► BH3A5000

► BH3A10000

- Auto-rising jack stands
- The stand raises automatically by pulling the lever upwards
- NO efforts to raise the stand thanks to a spring inside the pole
- One free hand
- TÜV-GS approved



Icon	HESS 731151+	Icon	Icon	Icon	Icon	Icon	Icon
BH3A5000	*0234653	1	10x540	403	620	5000	8
BH3A10000	*0234660	1	95x690	526	776	10000	19
EAN code (*) 731415+							

► BH730

► BH750

- Certified according to 2006/42/EC
- Hydraulic Presses with robust welded frame with exclusive rounded shape design
- Large pressure gauge for easy reading at convenient eyes level
- Sliding and chromed piston
- Rulers to ease centering the piston with the item to extract
- 2 V blocks included usable on V or flat side depending the need
- Auto-centering pins for the table with safety locking springs
- Double speed pump with built-in safety overload valve
- Pressing pins set with 8 pins and a punch plate included
- All handles isolated

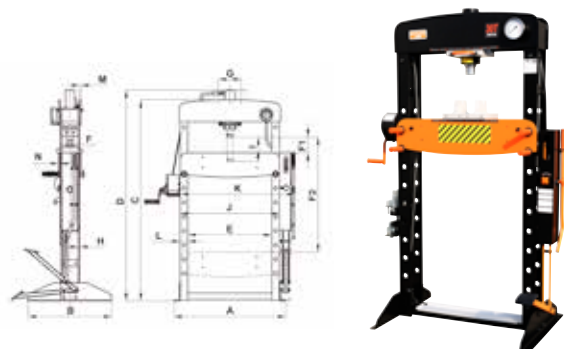

Icon	HESS 731151+	Icon	Icon	A mm	B mm	C mm	D mm	E mm	F1 mm	F2 mm	F mm	G mm	H mm	I mm	J mm	K mm	L mm	M mm	N mm	Icon
BH730	*0235667	1	30.000	960	700	1.780	1.810	700	140	1.020	140	200	10	160	860	990	80	10	10	189
BH750	*0235674	1	50.000	1.010	770	1.835	1.855	730	173	1.013	205	280	12	200	910	1.070	90	12	12	301
EAN code (*) 731415+																				

► BH230

- Certified according to 2006/42/EC + BS EN1494
- 30t air hydraulic jack
- Extra-large rubber wheels
- 3 saddle extensions included:
45 mm
100 mm
250 mm
- Product weight: 95 kg
- Safety pressure valve



► BH2AC60-140

► BH2AC60V110



- Universal saddles
- Heavy duty
- Machined

Icon	HESS 731151+	Icon	Icon	Icon	Icon	Icon	Icon
BH230	*0264070	6	3200x880x510	360	627	30000	95
EAN code (*) 731415+							

Icon	HESS 731151+	Icon	Icon	Icon	Icon	Icon	Icon
BH2AC60-140	*0168958	1	100x150x150			x	1
BH2AC60V110	*0178933	1	100x150x150	x			1
EAN code (*) 731415+							

► **BH11500**

- 1.5 t low entrance trolley jack
- Extra large rounded foot pedal for ease of use in any position
- Dual pistons which decreases the number of pump strokes by 50%
- Piston dust cover
- Polyurethane steel covered wheels
- Rubber saddle
- Storage tray
- Safety pressure valve
- Safety lowering valve



BH11500	*0178797	1	1.5	70	610	945	+/-10	119	X	190x940x415	51
EAN code (*) 731415+											

► **BH12000**

- 2 t low entrance trolley jack
- Extra large rounded foot pedal for ease of use in any position
- Dual pistons which decreases the number of pump strokes by 50%
- Piston dust cover
- Polyurethane steel covered wheels
- Rubber saddle
- Storage tray
- Safety pressure valve
- Safety lowering valve



BH12000	*0178803	1	2	70	490	790	+/-10	119	X	180x790x400	44.6
EAN code (*) 731415+											

► **BH13000**

- 3 t compact trolley jack
- Extra large rounded foot pedal for easy of use in any position
- Dual pistons which decreases the number of pump strokes by 50%
- Piston dust cover
- Polyurethane steel covered wheels
- Rubber saddle
- Storage tray
- Safety pressure valve
- Safety lowering valve



BH13000	*0178810	1	3	90	552	820	+/-10	119	X	200x710x390	50.5
EAN code (*) 731415+											

► **BH1A2500**

- 2.5 t aluminium trolley jack
- 100 % aluminium body and lifting arm
- Storage tray
- Detachable handle
- Safety pressure valve
- Safety lowering valve



BH1A2500	*0170555	1	2.5	95	485	740	6	120	X	800x370x200	25
EAN code (*) 731415+											



► **BH15000A**

► **BH11000A**



- BH15000A is a Trolley jack 5T and BH110000A is a trolley jack of 10T
- Large and comfortable pedal easing access for quick approach to the lifting points from right of left sides
- Certified according to 2006/42/EC + BS EN1494

BH15000A	*0272693	1	5	150	570	1354	65	107	X	190x1394x375	89
BH110000A	*0272709	1	10	170	565	1354	125	150	X	2626x1260x408	145

EAN code (*) 731415+

► **BH6FC2000**

- Certified according to 2006/42/EC + BS EN1494
- Certified according to 2006/42/EC + BS
- 2 t foldable crane
- Foldable body and 4 fixed positions of the lifting arm: 2000, 1500, 1000 and 500 kg
- Dual effect cylinder which decreases the number of pump strokes by 50%
- Min entry height: 130 mm
- Max hook height: 2640 mm
- Swivelling lever for comfortable pumping from all positions
- "Dead man" safety mechanism
- Overload valve
- Swivel safety hook



BH6FC2000	*0234639	1	1950x580x570	2000	1500	1000	500	130	+70		168

EAN code (*) 731415+

► **BH5US1000**



- Gyrosopic adjustable universal saddle 1000kg capacity with chains for securing the transmission
- Possible to swivel and adjust the transmission in different angles
- Heavy duty solid mounting plates
- Fits on transmission jacks ref. BH5SP500QA and BH5DP1000QA

BH5US1000	*0243174	1	340x400x420	1000	12,2

EAN code (*) 731415+

► **BH4**



- Certified according to 2006/42/EC + BS EN1494
- Bottle jacks for heavy duty use
- Welding construction with double seals preventing body leaks
- Arc surface of the steel base to control the centring of the load in the axis of the piston
- Working conditions: -20 to 70°C

BH42	*0178698	1	185x130x110	172	372	5000	3.95
BH45	*0178704	1	225x135x120	212	468	5000	5.05
BH410	*0178711	1	230x150x145	220	483	10000	7.56
BH415	*0178728	1	240x165x150	231	498	15000	10.12
BH420	*0178735	1	250x180x170	241	521	20000	13.32
BH430	*0178780	1	270x195x185	244	492	30000	16.11

EAN code (*) 731415+

► **BBA12-1200**

► **BBA1224-1700**

- Application: to boost vehicles
- 1200 CA on clamps for BBA12-1200 and for BBA1224-1700 1700 CA on clamps at 12 V; 900 CA at 24 V
- New AGM battery: 15-20% more powerful than previous AGM battery
- Dual warning for polarity inversion
- Strong and durable rotomolded housing with 2 component comfort grip
- Double insulation thick copper cables for best conductivity and less leaks
- Strong durable insulated brass clamps with inner bridge
- Illuminated voltmeter
- Poka-yoke On-off switch
- 12V output / 500A internal fuse
- Easy control system for internal fuse checking
- External intelligent electronic charger
- Charging status control LED on charger



			V	CA	output A	h	Ah	mm	mm	A	mm	mm	mm	kg	
BBA12-1200	*0254330	1	12	1200	12 V	5	28	35	1.85	-25^{°C}<70	4	210	45	500	17
BBA1224-1700	*0254347	1	12/24	1700/900	12 V	10	28	50	1.85	-25^{°C}<70	4	210	45	500	30

EAN code (*) 731415+

► **BBC620**

- Battery Charger-starter
- Application: Automatic battery charger and starter 12/24V single phase 230V
- Battery charger and starter for charging free electrolyte batteries (WET, CA, Pb and AGM) with 12/24V voltage and starting all kinds of cars, vans and light trucks
- Characteristics:
 - Choice of normal charge or quick charge (BOOST)
 - Quick start
 - Display of charging and starting current
 - Protection against overloads, short circuits and polarity reversal
 - Nominal capacity: 20/1000Ah for the BBC420 and 20/1550Ah for the BBC620
 - Timer for setting the time boost on the BBC620(0-60')



			V	Hz	12-24 V	kW	A _{EFF}	A _{EN}	CA	Ah	mm	mm	kg
BBC620	*0243242	1	230	50/60	12-24 V	2-10	90	70	570	20/1550	325x465x730	26	

EAN code (*) 731415+

► **BP815K1**

- Impact wrench kit 1/2"
- Supplied in a robust plastic case
- Foam inlay fits into Bahco T-module system T12
- Contains:
 - 1 pc BP815 1/2" Impact wrench
 - Impact sockets: 10, 11, 12, 13, 14, 15, 17, 19, 21, 22, and 24 mm
 - 1/4" threaded male connector



► **BP817**

- Impact wrench 3/4"
- Composite housing
- Twin hammer mechanism
- Power regulator
- Swivel connection
- Air exhaust in handle



			BAR	mm	mm	mm	mm	mm	mm	mm	mm	mm	mm	mm	kg
BP815K1	*0181957	1	1/2"	6.3	1/4"	10	130	320-620	825	7,000	1,150	84	5	192	1.95
BP817	*0134016	1	3/4"	6.3	3/8"	10	190	340-950	1,800	4,500	970	88	4.30	245	3.95

EAN code (*) 731415+

1. All hand tools in the catalogue are offered with a lifetime warranty; a warranty against material and manufacturing defects for the normal lifetime of the tool in question. "Lifetime" is defined as the period of time a tool can be expected to last under normal use and conditions.
2. SNA Europe's range of power tools, pneumatic tools and measuring tools are excluded from point 1 and each has a separate warranty card supplied with the product covering the specific warranty conditions. Products are designed and manufactured for professional use. The warranty period is one year (12 months) for professional use and two years (24 months) for private use. The warranty period starts on the purchase date. This date may be verified with the invoice or any other document of legal value.
3. Defective product will be repaired, replaced or substituted. SNA Europe does not provide for the transportation cost for repaired, replaced or substituted product.
4. Any product that has been incorrectly used and/or maintained or that is worn from improper use or that has suffered unauthorized modifications is not covered by this warranty.
5. A warranty claim must be submitted within the warranty period. This requires the submission or shipment of the complete tool in question with verification of sale documentation, which must validate the purchase date and the product designation, to the retailer or distributor.
6. Replacement or repair of the product will be carried out as quickly as possible. At the reception of the replaced or repaired product the customer is asked to validate conformity. Replacements and repairs provided under the warranty do not lengthen or renew the warranty period for the tool.

This catalogue comprise of our current product assortment. Changes in the assortment as well as change of net shapes, forms, designs and designations are made continuously. No specific information will necessarily be issued to this effect. Illustrations and drawings have been reproduced to be as accurate as possible. For the purposes of a catalogue they may, however, differ from the products themselves, as may the technical specifications. Indications of weight are to be understood as approximate net weights, and serve primarily to facilitate calculations of freight and postage charges. This catalogue supersedes all previous specifications and assortment lists. The intellectual property in this catalogue is the property of SNA Europe.

Extracts, reprints or copies of the contents may be made with our permission.

2015



AP-234-F	7311518289027	2	35
AP-3M	7311518152062	1	35
AP-5M	7311518152079	1	35
BBA12-1200	7314150254330	1	71
BBA1224-1700	7314150254347	1	71
BBC620	7314150243242	1	71
BE-8675	7314150123872	1	63
BE-9770	7314150027712	3	63
BE-9881	7314150043279	1	64
BH110000A	7314150272709	1	70
BH11500	7314150178797	1	69
BH1A2500	7314150170555	1	69
BH12000	7314150178803	1	69
BH13000	7314150178810	1	69
BH15000A	7314150272693	1	70
BH230	7314150264070	6	68
BH2AC60-140	7314150168958	1	68
BH2AC60V110	7314150178933	1	68
BH3A5000	7314150234653	1	68
BH3A10000	7314150234660	1	68
BH410	7314150178711	1	70
BH415	7314150178728	1	70
BH42	7314150178698	1	70
BH420	7314150178735	1	70
BH430	7314150178780	1	70
BH45	7314150178704	1	70
BH5DP1000QA	7314150270224	1	68
BH5US1000	7314150243174	1	70
BH6FC2000	7314150234639	1	70
BH730	7314150235667	1	68
BH750	7314150235674	1	68
BLTFC1	7314150246434	20	64
BLTS6I	7314150246458	15	64
BLTS7P	7314150246410	5	64
BP815K1	7314150181957	1	71
BP817	7314150134016	1	71
ECO-LUBE100	7311518249434	4	57
FCP-1.8-810	7311518123970	4	50
FCP-2.3-860	7311518123994	2	50
FFSS-1.5-900FG	7311518275884	4	50
FGS-1.0-600	7311518123796	4	49
FGS-1.25-700	7311518123802	4	49
FGS-1.6-810	7311518123819	4	50
FGS-1.8-810	7311518123826	4	50
FP-3M	7311518168612	1	35
FS-5	7311518266455	10	45
FS-7.5	7311518266479	10	45
FS-8	7311518266462	10	45
GL008-10	7314150167050	6	60
GL008-8	7314150167043	6	60
GL010-10	7314150167098	6	60
GL010-8	7314150167081	6	60
GL012-10	7314150167104	6	60
GL012-8	7314150167111	6	60
GS-180-F	7311518275488	6	41
GS-76	7311518010782	6	41
GS-76-SPRING-L	7311518332952	1	41
HFGPS-0,7-400FG	7311518275877	4	49
HGPS-0.6-360	7311518123680	4	49
HGPS-0.8-380	7311518123697	4	49
HGPS-1.0-400	7311518123703	4	49
HUS-0.6-380	7311518123659	4	49
HUS-0.8-500	7311518123666	4	49
HUS-1.0-650	7311518123673	4	49
K-AP-1	7311518030117	10	44
K-GP-1	7311518030131	10	44
LA010	7314150125821	12	64
LS-6160-23	7311518041304	1	56
LS-COIN 19 CM	7311518031077	4	52
LS-COIN 26 CM	7311518333041	4	52
LS-COMBINESS	7311518041366	1	56
LS-MASSE-4	7311518012014	2	52
LS-MASSE-4FG	7311518275891	2	52
LS-MASSE-TR-4FG	7311518281106	2	52
LS-MERLIN-2.5	7311518012069	2	51
LS-MERLIN-2.5FG	7311518281113	2	51
LS-NATURAL	7311518224622	1	56
LS-PIERRE CORINDON	7311518009977	30	56
LS-PIERRE-FAUX	7311518009038	1	56
LS-TRIANGLE	7311518224653	1	56
MCP-2.5-810	7311518124052	2	51



MES-3.0-900	7311518123864	2	51
MES-3.5-900	7311518123871	2	51
MES-3.5-900FG	7311518281120	2	51
MTS-5-25	7314150119233	6	63
MTT151	7314150120703	6	66
MTT051	7314150270521	6	66
MW-250	7314150125678	2	63
P108-20-F	7311518275518	2	10
P108-23-F	7311518275525	2	10
P1-20	7311518044572	5	10
P1-23	7311518332501	5	10
P11	7311518009076	6	44
P110-20-F	7311518275532	2	10
P110-23-F	7311518275549	2	10
P114-SL-40	7311518301149	2	21
P114-SL-50	7311518301156	2	21
P114-SL-60	7311518301163	2	21
P116-SL-40	7311518301101	2	21
P116-SL-50	7311518301118	2	21
P116-SL-60	7311518301125	2	21
P116-SL-70	7311518301132	2	21
P121-18-F	7311518275662	6	11
P121-20-F	7311518275631	6	11
P121-23-F	7311518275648	6	11
P123-19-BULK15	7311518226251	15	17
P123-19-BULK30	7311518218218	30	17
P123-19-BULK56	7311518240202	56	17
P126-19-F	7311518275297	6	11
P126-22-F	7311518275303	6	11
P127-19-BULK30	7311518199333	30	17
P128-19	7311518160814	6	17
P128-19-BULK30	7311518172329	30	17
P129-19-BULK30	7311518172336	30	17
P130-F	7311518333980	6	22
P138-22-F	7311518301279	6	11
P140-F	7311518275372	2	22
P160-SL-60	7311518301170	2	21
P160-SL-75	7311518301187	1	21
P160-SL-90	7311518301194	1	21
P16-40	7311518013479	2	21
P16-40W	7311518043049	2	21
P16-50-F	7311518301286	2	21
P16-60-F	7311518276461	2	21
P172-SL-85	7311518301200	1	21
P19-80-F	7311518275365	1	21
P20	7311518009281	6	44
P262	7311518299286	10	47
P263	7311518299262	10	47
P264	7311518299279	10	47
P266	7311518299293	10	47
P267	7311518299309	10	47
P268	7311518299316	10	47
P269	7311518299323	10	47
P270	7311518299330	10	47
P272	7311518299354	5	46
P274	7311518299347	5	46
P276	7311518299361	5	46
P277	7311518299378	5	46
P278	7311518299385	5	46
P280-SL-80	7311518301330	2	21
P3-20-F	7311518275259	2	10
P3-23-F	7311518275266	2	10
P34-27A-F	7311518275464	2	34
P34-37	7311518002787	2	34
P51-F	7311518275426	2	39
P51H-SL	7311518301224	2	39
P51-SL	7311518301217	2	39
P5-20-F	7311518275273	2	10
P5-23-F	7311518275280	2	10
P54H-SL-20	7311518301262	2	39
P54H-SL-25	7311518301255	2	39
P54-SL-20	7311518301248	2	39
P54-SL-25	7311518301231	2	39
P57-25-F	7311518301293	4	39
P57-25-W-F	7311518301309	4	39
P59-25-F	7311518275655	5	40
P64-20	7311518288174	1	11
P64-20-BULK12	7311518288204	12	11
P74	7311518124076	1	41
P75	7311518124083	1	41
PG-01-F	7311518329334	6	11



PG-03-L	7311518242855	6	11
PG-12-F	7311518328122	6	11
PG-17-F	7311518324629	2	22
PG-18-45-F	7311518299033	2	22
PG-18-60-F	7311518288853	2	22
PG-19-F	7311518295936	2	22
PG-56-F	7311518288938	2	40
PG-57-F	7311518295943	2	40
PG-72	7311518242534	4	29
PG-L2-F	7311518269746	2	11
PG-M2-F	7311518269715	2	11
PG-R-M2-F	7311518269722	2	11
PG-S1-F	7311518327743	2	11
PH-6604-1P	7311518152819	15	55
PH-6604-25	7311518141134	25	55
PROF-H	7311518158439	2	59
PROF-LOPP	7311518288549	1	60
PROF-SEC	7311518288532	1	59
PX-L2	7311518233853	2	10
PX-L3	7311518233860	2	10
PX-M1	7311518233815	2	10
PX-M2	7311518233822	2	10
PX-M2-L	7311518240714	2	10
PX-M3	7311518233839	2	10
PXR-L2	7311518233914	2	10
PXR-M1	7311518233877	2	10
PXR-M2	7311518233884	2	10
PXR-M2-L	7311518240738	2	10
PXR-M3	7311518233891	2	10
PXR-S1	7311518240677	2	10
PXR-S2	7311518240684	2	10
PX-S1	7311518233785	2	10
PX-S2	7311518233792	2	10
R1068	7311518044398	1	12
R1071	7311518222918	1	17
R1075-BULK50	7311518220495	50	17
R112PG	7311518010058	1	12
R113PG	7311518044374	1	12
R114PG	7311518010065	1	12
R115V	7311518243210	1	23
R115V-BULK14	7311518288341	14	23
R116V	7311518010164	1	23
R116V-BULK36	7311518159924	36	23
R119V	7311518029487	1	23
R122PG	7311518010072	1	12
R123PG	7311518044381	1	12
R124PG	7311518010089	1	12 & 34
R133PG	7311518328252	1	34
R137E	7311518011574	1	34
R141P	7311518288235	1	12
R142P	7311518010126	1	12 & 34
R143PV-BULK50	7311518240837	50	23
R143PVCB	7311518255633	1	23
R144PV	7311518291075	1	23
R146VC	7311518046545	1	40 & 41
R147V	7311518044909	1	40
R160A	7311518201821	1	23
R16V	7311518254513	1	23
R16V-BULK14	7311518288334	14	23
R166V	7311518328085	1	23
R181P	7311518296087	1	23
R1269P-BULK50	7311518240820	50	13
R211P	7311518234027	1	12
R211P-BULK80	7311518252212	80	12
R214SL	7311518301392	1	23
R216SL	7311518301408	1	23
R221P	7311518229412	1	12
R221P-BULK50	7311518240653	50	12
R223P	7311518237554	1	12
R223P-BULK80	7311518240646	80	12
R260A	7311518201814	1	23
R300P	7311518234034	1	12
R303P	7311518234157	1	12
R318V	7311518029500	1	19 & 23
R328V	7311518296056	1	23
R337E	7311518011598	1	34
R341P	7311518011529	1	13
R372H	7311518235406	18	23
R380A	7311518000066	1	23
R403P	7311518234164	1	12
R415V	7311518243241	1	23



R427AE	7311518176068	1	34
R430V	7311518243265	1	23
R437E	7311518011611	1	34
R438P	7311518229429	1	12
R438P-BULK50	7311518240660	50	12
R440V	7311518254544	1	23 & 40
R444V	7311518243340	1	40
R463P	7311518223908	1	12
R474P	7311518011536	1	13
R500P	7311518234041	1	12
R503P	7311518234171	1	12
R515VS	7311518046514	1	23 & 40
R516V	7311518200824	1	23 & 40
R519V	7311518029517	1	23
R600P	7311518240783	1	12
R603P	7311518240790	1	12
R615V	7311518010119	1	23
R619V	7311518029494	1	23
R660V	7311518210281	1	23
R716VCB	7311518255497	1	23
R772V	7311518301385	1	23
R773V	7311518324414	1	23
R801P	7311518234126	1	13
R802P	7311518234133	1	13
R803P	7311518234140	1	13
R804P	7311518240806	1	13
R811P	7311518234058	1	13
R812P	7311518234065	1	13
R813P	7311518234072	1	13
R815P	7311518240752	1	13
R900P	7311518234188	1	12
R901P	7311518234195	1	13 & 23
R902P	7311518234201	1	13
R903P	7311518234218	1	13
R904P	7311518234225	1	13
R905P	7311518234232	1	12
R905P-BULK50	7311518252250	50	12
R906P	7311518234249	1	12
R906P-BULK50	7311518252267	50	12
R907P	7311518234256	1	12
RT821P	7311518242237	1	13
RT822P	7311518234102	1	13
RT823P	7311518234119	1	13
RT824P	7311518240776	1	13
S240	7314150104017	4	65
S410	7314153019370	2	65
S530T	7314150169122	4	65
S910	7314150104000	2	65
SAP-X	7311518225728	6	57
SB-2444	7314150189250	1	44
SE-15-24	7311518029838	5	37
SE-15-30	7311518029821	5	37
SE-15-30-23	7311518029845	5	37
SE-15-32	7311518249168	5	37
SE-15-36	7311518141202	5	37
SE-15-36-23	7311518258276	5	37
SE-16-21	7311518029807	5	37
SE-16-21-23	7311518273934	5	37
SHARP-X	7311518264895	10	56
SHARP-X-DISP	7311518264901	30	56
SH-FCP-860	7311518324421	1	53
SH-FCS-810	7311518140540	1	53
SH-FCS-860	7311518140557	1	53
SH-FGS-600	7311518140649	1	53
SH-FGS-700	7311518140656	1	53
SH-FGS-800	7311518140663	1	53
SH-HFGPS-400FG	7311518282301	1	53
SH-HGPS-360	7311518140618	1	53
SH-HGPS-380	7311518140625	1	53
SH-HGPS-400	7311518207618	1	53
SH-HUS-380	7311518140502	1	53
SH-HUS-500	7311518140519	1	53
SH-HUS-650	7311518140526	1	53
SH-MCS-800	7311518140595	1	53
SH-MES-900	7311518140601	1	53
SH-MES-900FG	7311518282318	1	53
SH-MES-F-900	7311518141554	1	53
SH-SUS-800	7311518140809	1	53
SL25L	7314150256570	10	65
SLX 17	7314153015785	1	65
SOZ150003	7314153013477	6	66



SQZ150003-HSBL	7314153015389	1	66
SUS-2.0-800	7311518123451	2	51
W-S-1.5	7311518140816	4	52
W-S-2.0	7311518140823	4	52
W-S-2.5	7311518140830	4	52
W-T-2.0	7311518140847	4	52
10-21-51	7311518229344	5	37
10-24-23	7311518229368	5	37
10-24-51	7311518229351	5	37
10-30-23	7311518229382	5	37
10-30-51	7311518229375	5	37
1446	7314150128631	15	44
1470K5	7314150136162	1	67
1475K8PC	7314150182923	2	67
1475K8PCM	7314150182930	2	67
1475K8PDG	7314150183302	2	67
1475K8PEV	7314150182947	2	67
1475K8PSP	7314150183357	2	67
1475K8PJJ	7314150182961	2	67
1475K8PAW	7314150182978	2	67
1475K8PSV	7314150186952	1	67
1520 D	7311518278922	5	62
166-6-16-2.5-12	7311518021979	12	55
166-6-16-2.5-2	7311518209698	5	55
167-8-21-3.2-12	7311518021986	12	55
168-6-3.2-1P	7311518152338	12	54
168-6-3.2-3P	7311518152413	12	54
168-6-3.5-1P	7311518152345	12	54
168-6-3.5-3P	7311518152420	12	54
168-8-4.0-1P	7311518152352	12	54
168-8-4.0-3P	7311518152437	12	54
168-8-4.0-6	7311518217419	6	54
168-8-4.5-1P	7311518152369	12	54
168-8-4.5-3P	7311518152444	12	54
168-8-4.5-6	7311518217426	6	54
168-8-4.8-1P	7311518152376	12	54
168-8-4.8-3P	7311518152451	12	54
168-8-4.8-6	7311518217433	6	54
168-8-5.2-1P	7311518152383	12	54
168-8-5.2-3P	7311518152468	12	54
168-8-5.2-6	7311518217440	6	54
168-8-5.5-1P	7311518152390	12	54
168-8-5.5-3P	7311518152475	12	54
168-8-5.5-6	7311518217457	6	54
168-8-6.3-1P	7311518152406	12	54
168-8-6.3-3P	7311518152482	12	54
168-COMBI-4.0	7311518209667	1	54
168-COMBI-4.8	7311518209674	1	54
168-COMBI-5.5	7311518209681	1	54
168-COMBI-4.0-6922	7311518209612	1	54
168-COMBI-4.8-6920	7311518209643	1	54
168-COMBI-5.5-6924	7311518209650	1	54
2303H0000	8413345091466	6	63
23-15	7311518274665	10	36
23-21	7311518012274	10	36
23-24	7311518003852	10	36
23-30	7311518003869	10	36
23-32	7311518003876	10	36
23-36	7311518003883	10	36
2339 D	7314150032792	3	62
2339 DIP	7314150103508	5	62
2444	7311518286750	15	44
308506000	8413345035163	1	63
3100TB	7314150125364	1	67
331-15-23	7311518274658	5	37
331-21-51-KP	7311518003814	5	37
332-21-51	7311518229337	5	37
333	7311518005832	5	37
333-5	7311518005849	10	36
339-6T	7311518128371	4	31
340-6T	7311518002008	4	31
349	7311518018924	4	29
3625RM-75	7314153019820	6	62
383-6T	7311518128876	4	31
384-5T	7311518159795	4	31
384-6T	7311518002039	4	31
385-6T	7311518002053	4	31
386-6T	7311518152017	4	31
3875-LY1	7314150191253	8	61
3875-LY2	7314150191260	8	61
3875-LY3	7314150191284	8	61



3875-RL1	7314150194780	1	61
3875-WL1	7314150191291	8	61
396-BLADE-1P	7311518330613	1	31
396-HP	7311518152284	4	29
396-HP-BLADE	7311518156404	1	31
396-JS	7311518223250	4	28
396-JS-BLADE	7311518223267	1	31
396-JT	7311518168056	4	27
396-JT-BLADE	7311518168063	1	31
396-LAP	7311518172367	10	29
4124-JT-H	7311518267803	4	27
4128-JT-H	7311518267810	4	27
4-153-08-1-2	7311518000707	5	55
4211-11-6T	7311518152000	4	30
4211-14-6T	7311518128883	4	30
4212-11-6T	7311518002060	4	30
4212-14-6T	7311518002077	4	30
4-272-05-3-2	7311518201500	5	55
4-272-06-3-2	7311518001025	5	55
439000000	8413345129282	1	61
439000001	7314150268788	1	61
4400-11	7311518200596	10	31
4400-11-BULK	7311518200633	10	31
4400-14	7311518200602	10	31
4400-14-BULK	7311518200640	10	31
4420-11	7311518200619	10	31
4420-11-BULK	7311518200657	10	31
4420-14	7311518200626	10	31
4420-14-BULK	7311518200664	10	31
466-800	7314150128310	4	63
4724-JT	7311518265847	1	31
4728-JT	7311518265854	1	31
4750-2PP-1	7314153014733	1	59
4750-HDB-2	7314150289486	1	59
4750-KNHO-0	7314150289462	1	59
4750-KNHO-1	7314153015839	1	59
4750-MPH-1	7314150291625	1	60
484-1250	7311518005139	4	62
485	7311518005153	4	62
51-21	7311518003906	10	36
51-24	7311518003913	10	36
5124-JS-H	7311518219352	4	28
5128-JS-H	7311518219369	4	28
51-30	7311518003920	10	36
51-32	7311518003937	10	36
51-36	7311518003944	10	36
5724-JS	7311518216085	1	31
5728-JS	7311518216092	1	31
59S/31-1	7314150191451	12	65
7823	7314150218141	16	65
808050P	7314150128105	50	64
8224	7314150000012	5	62
8224CIP	7314150103607	5	62
8224IP	7314150101757	5	62
9210	7311518278182	1	18
9210-1	7311518278212	1	19
9210-10	7311518278229	1	19
9210-1060177	7311518295424	1	19
9210-1060238	7311518295394	20	19
9210-11	7311518296094	1	19
9210-1230219	7311518295387	10	19
9210-1230193	7311510248087	10	19
9210-1230235	7311518295325	10	19
9210-1320281	7311518295431	10	19
9210-1330110	7311510255757	1	19
9210-1590103	7311510248063	1	19
9210-1640141	7311510248070	1	19
9210-1640142	7311518295356	10	19
9210-1690148	7311518295332	1	19
9210-1700118	7311518295363	1	19
9210-1710265	7311510263509	6	19
9210-1710266	7311518295417	1	19
9210-1720100	7311518295295	10	19
9210-1730107	7311518295349	10	19
9210-1770106	7311518295370	40	19
9210-1830137	7311518295400	10	19
9210-20	7311518278236	1	19
9-486-C-10	7311518209599	10	55
9-486-C-1P	7311518209605	10	55
9571	7314150178582	5	62
9574-200	7314150138197	10	63
960100030	8413345031097	1	67

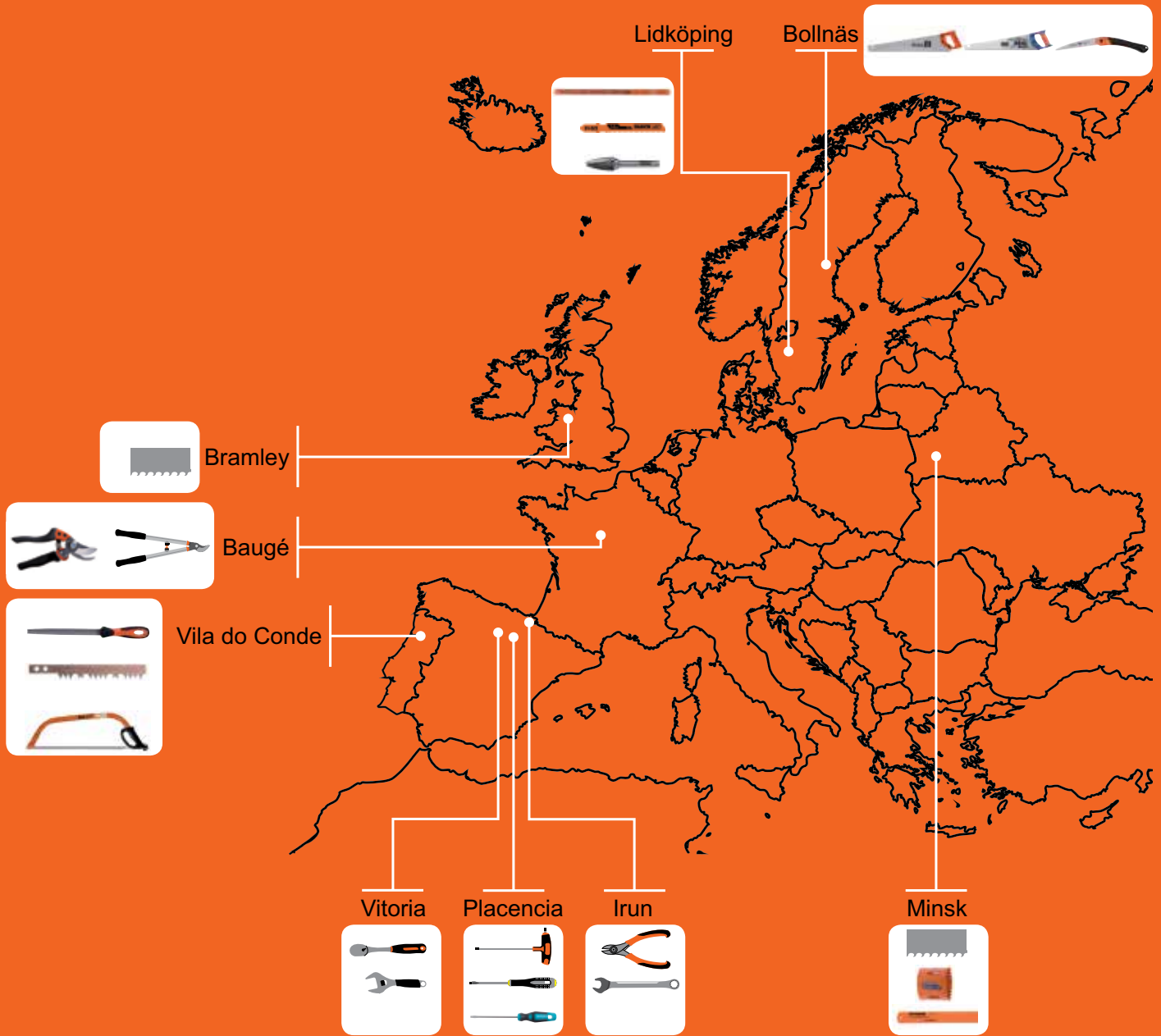

X-ON Electronics

Largest Supplier of Electrical and Electronic Components

Click to view similar products for [bahco manufacturer](#):

Other Similar products are found below :

[65I/7-1](#) [MK9](#) [BE-9675](#) [BE-9882I](#) [BE-9882S](#) [1RM-11](#) [KSR753-1P](#) [9070](#) [2101S-180](#) [BE-8705S](#) [3834-SET-95](#) [111M/11T](#) [SBS20-27](#)
[65I/T20-2P](#) [LINDSTROM SUPREME MODULE](#) [9073P](#) [1952M/17T](#) [1936M-16-17](#) [222D](#) [6M/S8](#) [6962L](#) [111M-15](#) [8074 IP](#) [8075 IP](#) [L7892](#)
[28M-10](#) [2928-200](#) [3906-300-24-100](#) [21HDG-200](#) [2223 D-150](#) [3417 NF](#) [3417NFB](#) [3417 NF VDE](#) [3419 B](#) [3736S/6](#) [3875-LY5](#) [3875-LY7](#)
[4532-B](#) [4532-BL](#) [4532-C](#) [480-20](#) [BE-8870](#) [CR W 03](#) [NS006-1011](#) [NS006-1213](#) [NS006-1214](#) [NS006-1617](#) [NS006-1819](#) [NS006-1920](#)
[TAH2628G-160](#)