

# Dual Micropower, 5V/ $\mu$ s Precision Rail-to-Rail Output Amplifier

## FEATURES

- **Excellent Slew Rate to Power Ratio**
  - **Slew Rate: 5V/ $\mu$ s**
  - **Maximum Supply Current: 100 $\mu$ A/Amplifier**
- **Maximum Offset Voltage: 30 $\mu$ V**
- **Maximum Offset Voltage Drift: 0.5 $\mu$ V/ $^{\circ}$ C**
- **High Dynamic Input Impedance**
- **Fast Recovery from Shutdown**
- **Maximum Input Bias Current: 3nA**
- **No Output Phase Inversion**
- **Gain Bandwidth Product: 400kHz**
- **Wide Specified Supply Range: 3V to 30V**
- **Operating Temperature Range: -40 $^{\circ}$ C to 125 $^{\circ}$ C**
- **DFN and MS8 Packages**
- **Rail-to-Rail Outputs**

## APPLICATIONS

- Precision Signal Processing
- 18-Bit DAC Amplifier
- Multiplexed ADC Applications
- Low Power Portable Systems
- Low Power Wireless Sensor Networks

## DESCRIPTION

The **LT<sup>®</sup>6020** is a low power, enhanced slew rate, precision operational amplifier. The proprietary circuit topology of this amplifier gives excellent slew rate at low quiescent power dissipation without compromising precision or settling time. In addition, unique input stage circuitry allows the input impedance to remain high during input voltage steps as large as 5V. The combination of precision specs along with fast settling makes this part ideal for MUX applications.

The low quiescent current of the LT6020 along with its ability to operate on supplies as low as 3V make it useful in portable systems. The LT6020-1 features a shutdown mode which reduces the typical supply current to 1.4 $\mu$ A.

The LT6020 is available in the small 8-lead DFN and 8-lead MSOP packages. The LT6020-1 is available in a 10-lead DFN package.

LT, LT, LTC, LTM, Linear Technology, SmartMesh and the Linear logo are registered trademarks and SoftSpan is a trademark of Linear Technology Corporation. All other trademarks are the property of their respective owners. Patent Pending.

## TYPICAL APPLICATION

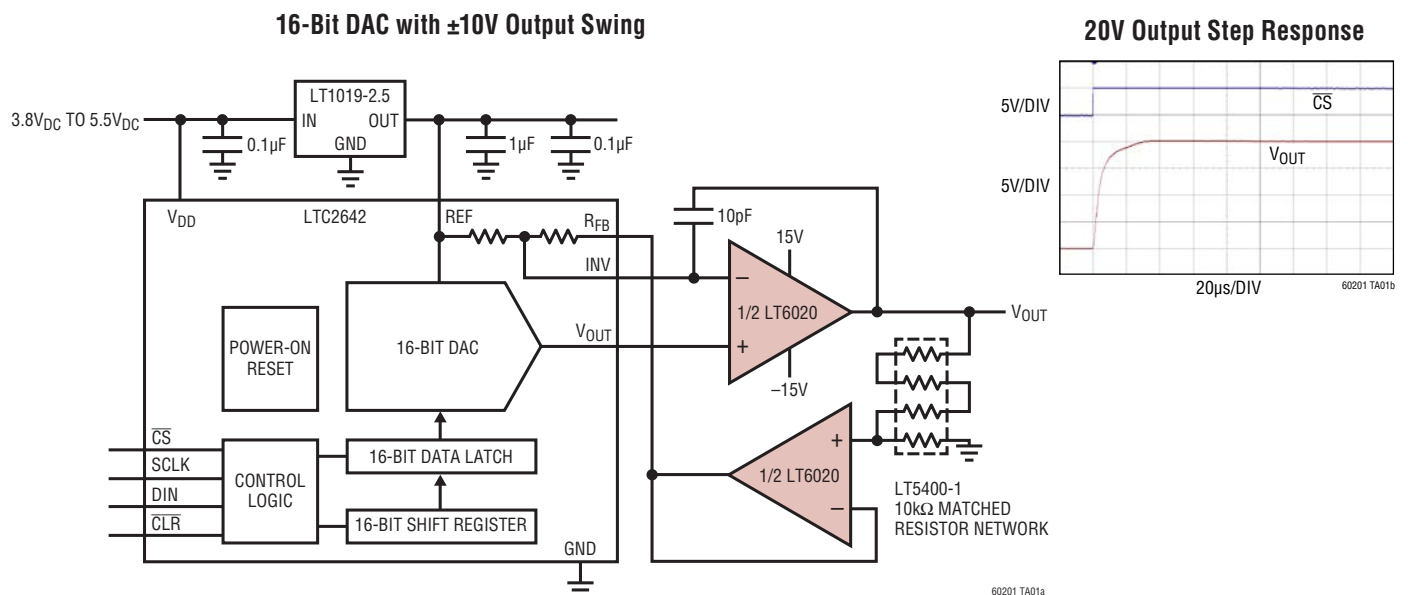

# LT6020/LT6020-1

## ABSOLUTE MAXIMUM RATINGS

(Note 1)

Total Supply Voltage ( $V^+$ to $V^-$ ) .....	36V	Operating and Specified Temperature Range	
Differential Input Voltage (within Supplies) .....	36V	I-Grade.....	-40°C to 85°C
Input Voltage (DGND, EN) (Relative to $V^-$ ) .....	36V	H-Grade .....	-40°C to 125°C
Input Current (+IN, -IN, DGND, EN) .....	±10mA	Junction Temperature .....	150°C
Output Short-Circuit Duration .....	Indefinite	Storage Temperature Range .....	-65°C to 150°C
		Lead Temperature (Soldering, 10 sec).....	300°C

## PIN CONFIGURATION

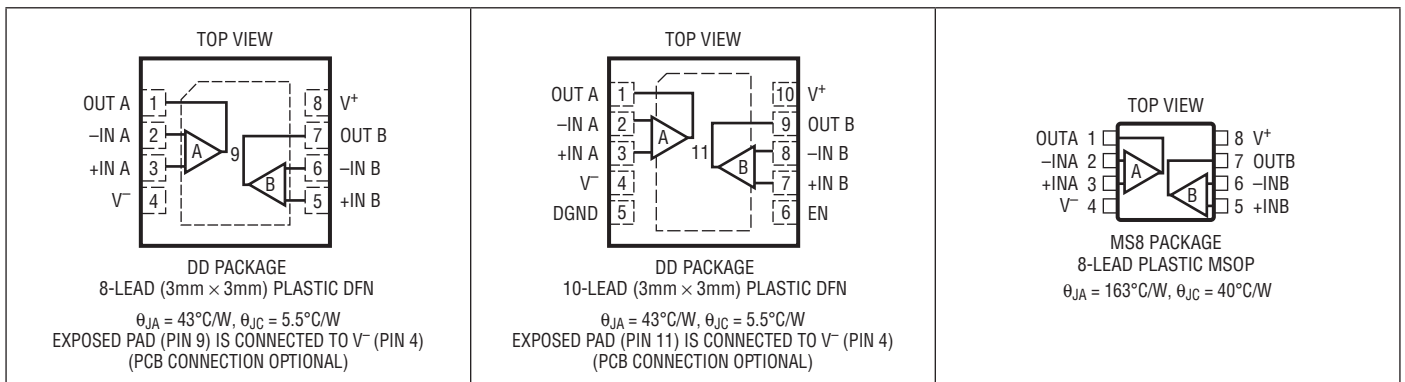

## ORDER INFORMATION

LEAD FREE FINISH	TAPE AND REEL	PART MARKING*	PACKAGE DESCRIPTION	TEMPERATURE RANGE
LT6020IDD#PBF	LT6020IDD#TRPBF	LGMC	8-Lead (3mm × 3mm) Plastic DFN	-40°C to 85°C
LT6020HDD#PBF	LT6020HDD#TRPBF	LGMC	8-Lead (3mm × 3mm) Plastic DFN	-40°C to 125°C
LT6020IDD-1#PBF	LT6020IDD-1#TRPBF	LGKF	10-Lead (3mm × 3mm) Plastic DFN	-40°C to 85°C
LT6020HDD-1#PBF	LT6020HDD-1#TRPBF	LGKF	10-Lead (3mm × 3mm) Plastic DFN	-40°C to 125°C
LT6020IMS8#PBF	LT6020IMS8#TRPBF	LTGJG	8-Lead Plastic MSOP	-40°C to 85°C
LT6020HMS8#PBF	LT6020HMS8#TRPBF	LTGJG	8-Lead Plastic MSOP	-40°C to 125°C

Consult LTC Marketing for parts specified with wider operating temperature ranges. \*The temperature grade is identified by a label on the shipping container.

For more information on lead free part marking, go to: <http://www.linear.com/leadfree/>

For more information on tape and reel specifications, go to: <http://www.linear.com/tapeandreeel/>

**ELECTRICAL CHARACTERISTICS** The ● denotes the specifications which apply over the specified temperature range, otherwise specifications are at  $T_A = 25^\circ\text{C}$ ,  $V_S = \pm 15\text{V}$ ,  $V_{CM} = V_{OUT} = \text{Mid-Supply}$ ,  $V_{DGND} = 0\text{V}$ ,  $V_{EN} = 5\text{V}$ . DGND and EN specifications only apply to the LT6020-1.

SYMBOL	PARAMETER	CONDITIONS	MIN	TYP	MAX	UNITS	
$V_{OS}$	Input Offset Voltage	DD Packages		20	70	$\mu\text{V}$	
		$T_A = -40^\circ$ to $85^\circ\text{C}$	●		110	$\mu\text{V}$	
		$T_A = -40^\circ$ to $125^\circ\text{C}$	●		120	$\mu\text{V}$	
		MS8 Package		5	30	$\mu\text{V}$	
		$T_A = -40^\circ$ to $85^\circ\text{C}$	●		70	$\mu\text{V}$	
		$T_A = -40^\circ$ to $125^\circ\text{C}$	●		80	$\mu\text{V}$	
$\frac{\Delta V_{OSI}}{\Delta \text{Temp}}$	Input Offset Voltage Drift (Note 2)	DD Packages	●	-0.8	$\pm 0.3$	0.8	$\mu\text{V}/^\circ\text{C}$
		MS8 Package	●	-0.5	$\pm 0.2$	0.5	$\mu\text{V}/^\circ\text{C}$
$\frac{\Delta V_{OSI}}{\Delta \text{Time}}$	Long Term Input Offset Voltage Stability		●		$\pm 0.2$	$\mu\text{V}/\text{Mo}$	
$I_B$	Input Bias Current			-3	$\pm 0.1$	3	nA
		$T_A = -40^\circ$ to $85^\circ\text{C}$	●	-3		3	nA
		$T_A = -40^\circ$ to $125^\circ\text{C}$	●	-10		10	nA
$I_{OS}$	Input Offset Current			-1	$\pm 0.1$	1	nA
		$T_A = -40^\circ$ to $85^\circ\text{C}$	●	-1		1	nA
		$T_A = -40^\circ$ to $125^\circ\text{C}$	●	-2		2	nA
	Input Noise Voltage	0.1Hz to 10Hz		1.1		$\mu\text{V}_{P-P}$	
$e_n$	Input Noise Voltage Density	$f = 10\text{Hz}$		50		$\text{nV}/\sqrt{\text{Hz}}$	
		$f = 1\text{kHz}$		46		$\text{nV}/\sqrt{\text{Hz}}$	
$i_n$	Input Noise Current Density	$f = 1\text{kHz}$		37		$\text{fA}/\sqrt{\text{Hz}}$	
$C_{IN}$	Input Capacitance	Common Mode		1.5		pF	
		Differential Mode		2.5		pF	
$R_{IN}$	Input Resistance	Common Mode		17		G $\Omega$	
		Differential Mode		20		M $\Omega$	
$V_{ICM}$	Common Mode Input Range		●	$V^- + 1.2$	$V^+ - 1.4$	V	
CMRR	Common Mode Rejection Ratio	$V_{CM} = -13.8\text{V}$ to $13.6\text{V}$	●	120	132	dB	
			●	120		dB	
PSRR	Supply Rejection Ratio	$V_S = 3\text{V}$ to $30\text{V}$	●	120	140	dB	
			●	118		dB	
$A_{VOL}$	Large-Signal Voltage Gain	$R_L = 6.98\text{k}\Omega$ , $V_{OUT} = \pm 14\text{V}$	●	110	116	dB	
			●	108		dB	
		$R_L = 100\text{k}\Omega$ , $V_{OUT} = \pm 14.5\text{V}$	●	126	138	dB	
			●	126		dB	
$V_{OL}$	Output Swing Low ( $V_{OUT} - V^-$ )	$R_L = 10\text{k}\Omega$			130	200	mV
		$T_A = -40^\circ$ to $85^\circ\text{C}$	●			250	mV
		$T_A = -40^\circ$ to $125^\circ\text{C}$	●			300	mV
$V_{OH}$	Output Swing High ( $V^+ - V_{OUT}$ )	$R_L = 10\text{k}\Omega$			100	140	mV
		$T_A = -40^\circ$ to $85^\circ\text{C}$	●			165	mV
		$T_A = -40^\circ$ to $125^\circ\text{C}$	●			190	mV
$I_{SC}$	Short-Circuit Current	$V_{OUT} = 0\text{V}$ , Sourcing			8	mA	
		$T_A = -40^\circ$ to $85^\circ\text{C}$	●	5.5		mA	
		$T_A = -40^\circ$ to $125^\circ\text{C}$	●	5		mA	
		$V_{OUT} = 0\text{V}$ , Sinking			11	mA	
		$T_A = -40^\circ$ to $85^\circ\text{C}$	●	5.5		mA	
		$T_A = -40^\circ$ to $125^\circ\text{C}$	●	5.5		mA	

# LT6020/LT6020-1

**ELECTRICAL CHARACTERISTICS** The ● denotes the specifications which apply over the specified temperature range, otherwise specifications are at  $T_A = 25^\circ\text{C}$ ,  $V_S = \pm 15\text{V}$ ,  $V_{CM} = V_{OUT} = \text{Mid-Supply}$ ,  $V_{DGND} = 0\text{V}$ ,  $V_{EN} = 5\text{V}$ . DGND and EN specifications only apply to the LT6020-1.

SYMBOL	PARAMETER	CONDITIONS	MIN	TYP	MAX	UNITS	
SR	Slew Rate	$A_{VCL} = 1$ , 10V Step	3	5		V/ $\mu\text{s}$	
		$T_A = -40^\circ$ to $85^\circ\text{C}$	2.4			V/ $\mu\text{s}$	
		$T_A = -40^\circ$ to $125^\circ\text{C}$	2.4			V/ $\mu\text{s}$	
		$A_{VCL} = 1$ , 5V Step	1.4	2.4		V/ $\mu\text{s}$	
		$T_A = -40^\circ$ to $85^\circ\text{C}$	1.1			V/ $\mu\text{s}$	
		$T_A = -40^\circ$ to $125^\circ\text{C}$	1			V/ $\mu\text{s}$	
GBW	Gain-Bandwidth Product	$f_0 = 10\text{kHz}$	290	400		kHz	
	Minimum Supply Voltage	Guaranteed by PSRR	3			V	
$I_S$	Supply Current per Amplifier	$T_A = -40^\circ$ to $85^\circ\text{C}$		90	100	$\mu\text{A}$	
		$T_A = -40^\circ$ to $125^\circ\text{C}$			125	$\mu\text{A}$	
	Supply Current in Shutdown	$V_{EN} = 0.8\text{V}$			1.4	3	$\mu\text{A}$
		$T_A = -40^\circ$ to $85^\circ\text{C}$				3.2	$\mu\text{A}$
		$T_A = -40^\circ$ to $125^\circ\text{C}$			3.6	$\mu\text{A}$	
$t_s$	Settling Time ( $A_V = 1$ )	0.1% 5V Output Step		6		$\mu\text{s}$	
		0.01% 5V Output Step		7.8		$\mu\text{s}$	
		0.0015% 5V Output Step		13.8		$\mu\text{s}$	
		0.0015% 10V Output Step		12.4		$\mu\text{s}$	
$t_{ON}$	Enable Time	$A_V = 1$		100		$\mu\text{s}$	
$V_{DGND}$	DGND Pin Voltage Range		$V^-$		$V^+ - 3$	V	
$I_{DGND}$	DGND Pin Current			-200	-400	nA	
$I_{EN}$	EN Pin Current			-100	-200	nA	
$V_{ENL}$	EN Pin Input Low Voltage	Relative to DGND			0.8	V	
$V_{ENH}$	EN Pin Input High Voltage	Relative to DGND	1.7			V	

**ELECTRICAL CHARACTERISTICS** The ● denotes the specifications which apply over the specified temperature range, otherwise specifications are at  $T_A = 25^\circ\text{C}$ ,  $V_S = 3\text{V}$ ,  $V_{\text{CM}} = V_{\text{OUT}} = \text{Mid-Supply}$ ,  $V_{\text{DGND}} = 0\text{V}$ ,  $V_{\text{EN}} = 3\text{V}$ . DGND and EN pin specifications only apply to the LT6020-1.

SYMBOL	PARAMETER	CONDITIONS	MIN	TYP	MAX	UNITS
$V_{\text{OS}}$	Input Offset Voltage	DD Packages $T_A = -40^\circ$ to $85^\circ\text{C}$ $T_A = -40^\circ$ to $125^\circ\text{C}$	●	20	100	$\mu\text{V}$
			●		140	$\mu\text{V}$
		MS8 Package $T_A = -40^\circ$ to $85^\circ\text{C}$ $T_A = -40^\circ$ to $125^\circ\text{C}$	●	5	45	$\mu\text{V}$
			●		85	$\mu\text{V}$
			●		95	$\mu\text{V}$
$\frac{\Delta V_{\text{OSI}}}{\Delta \text{Temp}}$	Input Offset Voltage Drift (Note 2)	DD Packages	●	-0.8	$\pm 0.3$	$\mu\text{V}/^\circ\text{C}$
		MS8 Package	●	-0.5	$\pm 0.2$	$\mu\text{V}/^\circ\text{C}$
$\frac{\Delta V_{\text{OSI}}}{\Delta \text{Time}}$	Long Term Input Offset Voltage Stability		●	$\pm 0.2$		$\mu\text{V}/\text{Mo}$
$I_B$	Input Bias Current			$\pm 1$		nA
$I_{\text{OS}}$	Input Offset Current			$\pm 0.1$		nA
	Input Noise Voltage	0.1Hz to 10Hz		1.1		$\mu\text{V}_{\text{p-p}}$
$e_n$	Input Noise Voltage Density	$f = 10\text{Hz}$		50		$\text{nV}/\sqrt{\text{Hz}}$
		$f = 1\text{kHz}$		46		$\text{nV}/\sqrt{\text{Hz}}$
$i_n$	Input Noise Current Density	$f = 1\text{kHz}$		37		$\text{fA}/\sqrt{\text{Hz}}$
$C_{\text{IN}}$	Input Capacitance	Common Mode		1.5		pF
		Differential Mode		2.5		pF
$R_{\text{IN}}$	Input Resistance	Common Mode		17		$\text{G}\Omega$
		Differential Mode		20		$\text{M}\Omega$
$V_{\text{ICM}}$	Common Mode Input Range		●	$V^- + 1.2$	$V^+ - 1.4$	V
CMRR	Common Mode Rejection Ratio	$V_{\text{CM}} = 1.2\text{V}$ to $1.6\text{V}$		125		dB
PSRR	Supply Rejection Ratio	$V_S = 3\text{V}$ to $30\text{V}$	●	120	140	dB
				118		dB
$A_{\text{VOL}}$	Large-Signal Voltage Gain	$R_L = 6.98\text{k}\Omega$ , $V_{\text{OUT}} = 0.5\text{V}$ to $2.5\text{V}$	●	98	108	dB
			●	98		dB
		$R_L = 100\text{k}\Omega$ , $V_{\text{OUT}} = 0.5\text{V}$ to $2.5\text{V}$		136		dB
$V_{\text{OL}}$	Output Swing Low ( $V_{\text{OUT}} - V^-$ )	$R_L = 10\text{k}\Omega$		45	100	mV
		$T_A = -40^\circ$ to $85^\circ\text{C}$	●		130	mV
		$T_A = -40^\circ$ to $125^\circ\text{C}$	●		150	mV
$V_{\text{OH}}$	Output Swing High ( $V^+ - V_{\text{OUT}}$ )	$R_L = 10\text{k}\Omega$		55	80	mV
		$T_A = -40^\circ$ to $85^\circ\text{C}$	●		90	mV
		$T_A = -40^\circ$ to $125^\circ\text{C}$	●		100	mV
$I_{\text{SC}}$	Short-Circuit Current	$V_{\text{OUT}} = 1.5\text{V}$ , Sourcing		6		mA
		$T_A = -40^\circ$ to $85^\circ\text{C}$	●	3.5		mA
		$T_A = -40^\circ$ to $125^\circ\text{C}$	●	3.5		mA
		$V_{\text{OUT}} = 1.5\text{V}$ , Sinking		8		mA
		$T_A = -40^\circ$ to $85^\circ\text{C}$	●	5.5		mA
		$T_A = -40^\circ$ to $125^\circ\text{C}$	●	5.5		mA
SR	Slew Rate (Note 3)	$A_{\text{VCL}} = -1$ , 2V Step		0.2		$\text{V}/\mu\text{s}$
GBW	Gain-Bandwidth Product	$f_0 = 10\text{kHz}$		400		kHz
		Minimum Supply Voltage	Guaranteed by PSRR	●	3	

# LT6020/LT6020-1

**ELECTRICAL CHARACTERISTICS** The ● denotes the specifications which apply over the specified temperature range, otherwise specifications are at  $T_A = 25^\circ\text{C}$ ,  $V_S = 3\text{V}$ ,  $V_{\text{CM}} = V_{\text{OUT}} = \text{Mid-Supply}$ ,  $V_{\text{DGND}} = 0\text{V}$ ,  $V_{\text{EN}} = 3\text{V}$ . DGND and EN pin specifications only apply to the LT6020-1.

SYMBOL	PARAMETER	CONDITIONS	MIN	TYP	MAX	UNITS
$I_S$	Supply Current per Amplifier	$T_A = -40^\circ$ to $85^\circ\text{C}$ ●		85	95	$\mu\text{A}$
		$T_A = -40^\circ$ to $125^\circ\text{C}$ ●			120 135	$\mu\text{A}$ $\mu\text{A}$
$t_s$	Settling Time ( $A_V = -1$ )	$V_{\text{EN}} = 0.8\text{V}$		0.9	1.1	$\mu\text{A}$
		$T_A = -40^\circ$ to $85^\circ\text{C}$ ●			1.5	$\mu\text{A}$
		$T_A = -40^\circ$ to $125^\circ\text{C}$ ●				3
$t_s$	Settling Time ( $A_V = -1$ )	0.1% 2.4V Output Step		12.4		$\mu\text{s}$
		0.01% 2.4V Output Step		21.2		$\mu\text{s}$
		0.0015% 2.4V Output Step		39.2		$\mu\text{s}$
$t_{\text{ON}}$	Enable Time	$A_V = 1$		120		$\mu\text{s}$
$V_{\text{DGND}}$	DGND Pin Voltage Range		●	$V^-$	$V^+ - 3$	V
$I_{\text{DGND}}$	DGND Pin Current			-200		nA
$I_{\text{EN}}$	EN Pin Current			-100		nA
$V_{\text{ENL}}$	EN Pin Input Low Voltage	Relative to DGND	●		0.8	V
$V_{\text{ENH}}$	EN Pin Input High Voltage	Relative to DGND	●	1.7		V

**Note 1:** Stresses beyond those listed under Absolute Maximum Ratings may cause permanent damage to the device. Exposure to any Absolute Maximum Rating condition for extended periods may affect device reliability and lifetime.

**Note 2:** Guaranteed by design.

**Note 3:** The slew rate of the LT6020 increases with the size of the input step. At lower supplies, the input step size is limited by the input common mode range. This trend can be seen in the Typical Performance Characteristics.

**TYPICAL PERFORMANCE CHARACTERISTICS**

$T_A = 25^\circ\text{C}$ ,  $V_S = \pm 15\text{V}$ ,  $R_L = 100\text{k}\Omega$ , unless otherwise specified.

**Typical Distribution of Input Offset Voltage**

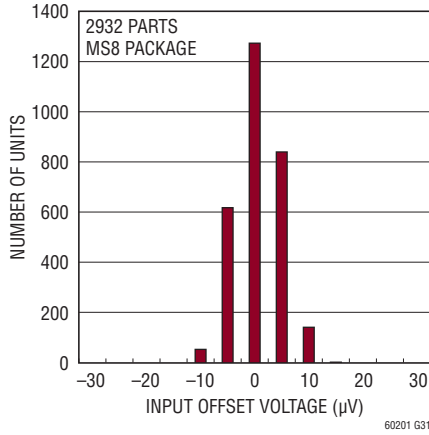

**Typical Distribution of Input Offset Voltage**

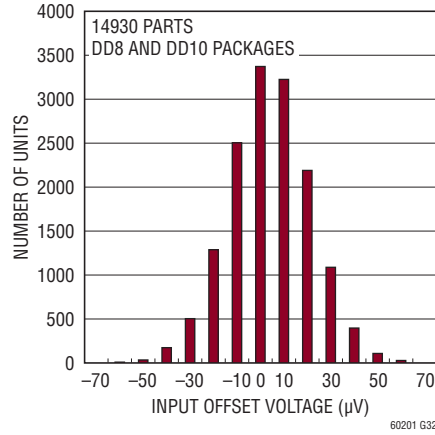

**Typical Distribution of Input Offset Voltage Drift**

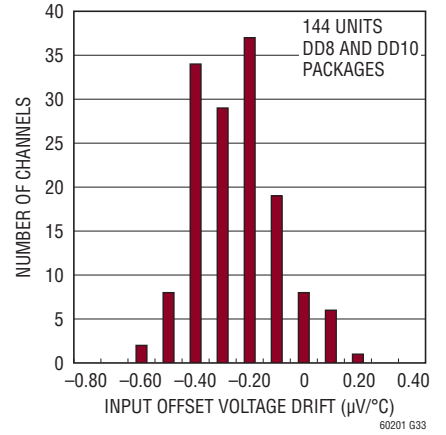

**Typical Distribution of Input Offset Voltage**

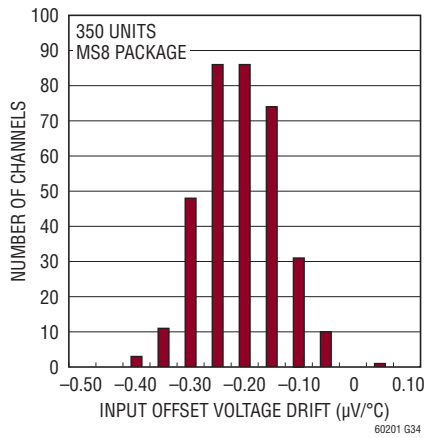

**Voltage Offset Shift vs Lead Free IR Reflow**

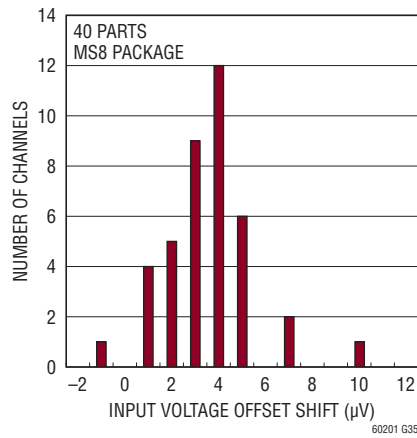

**Warm-Up Drift**

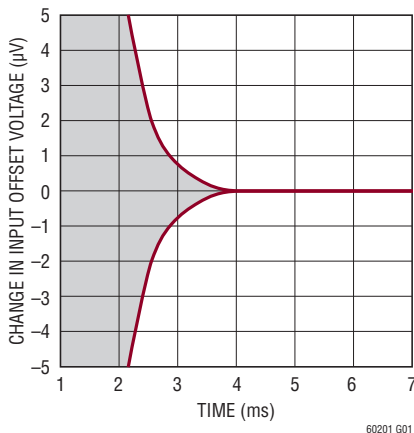

**Offset Voltage vs Supply Voltage**

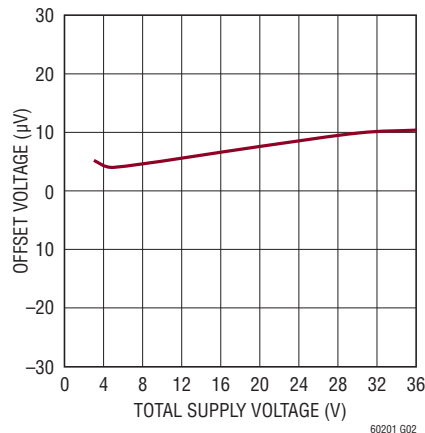

**Offset Voltage vs Input Common Mode Voltage**

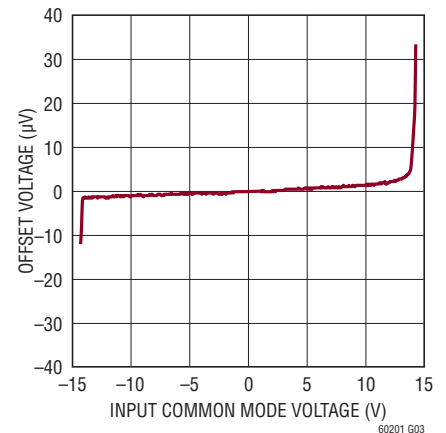

## TYPICAL PERFORMANCE CHARACTERISTICS

$T_A = 25^\circ\text{C}$ ,  $V_S = \pm 15\text{V}$ ,  $R_L = 100\text{k}\Omega$ , unless otherwise specified.

**Input Bias Current vs Temperature**

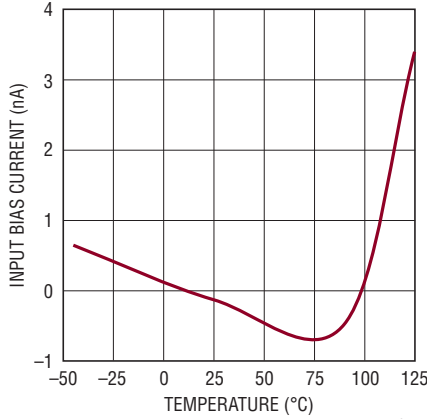

**Input Bias Current vs Differential Input Voltage**

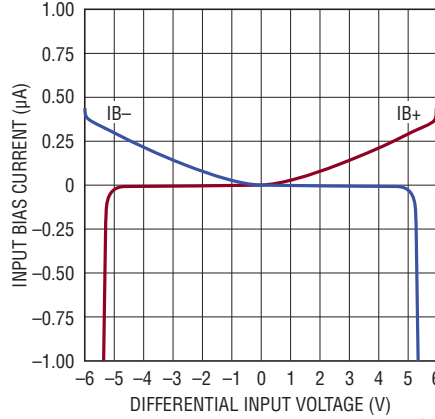

**0.1Hz to 10Hz Voltage Noise**

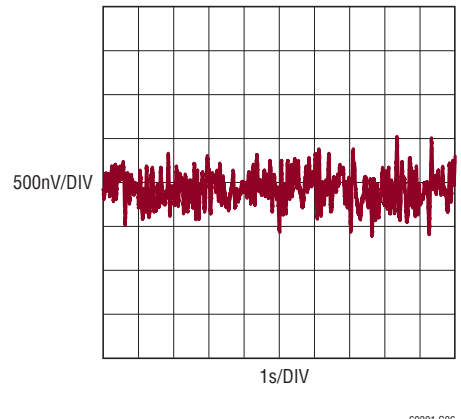

**Voltage Noise Density vs Frequency**

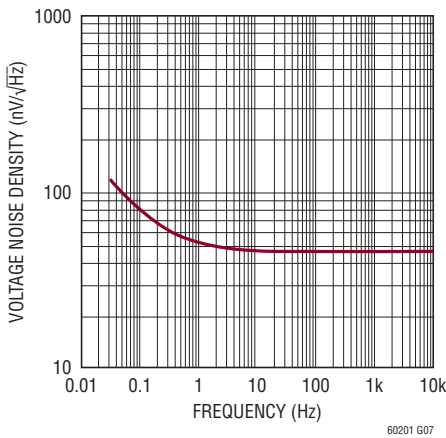

**Maximum Undistorted Output Amplitude vs Frequency**

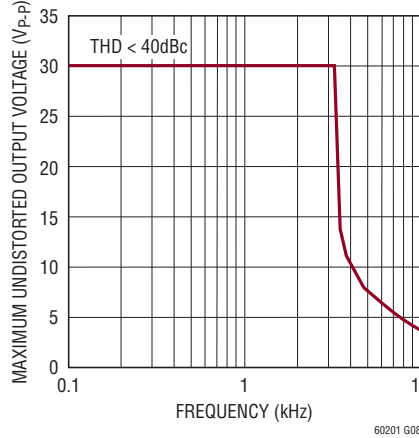

**Large-Signal Transient Response (5V Step)**

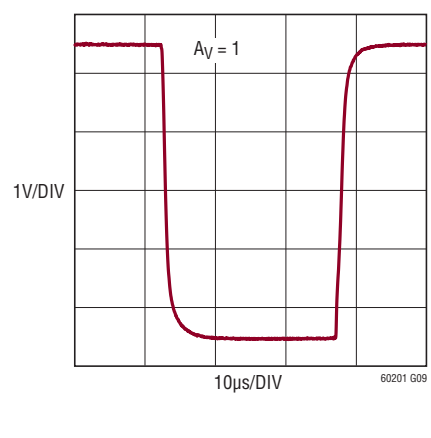

**Large-Signal Transient Response (10V Step)**

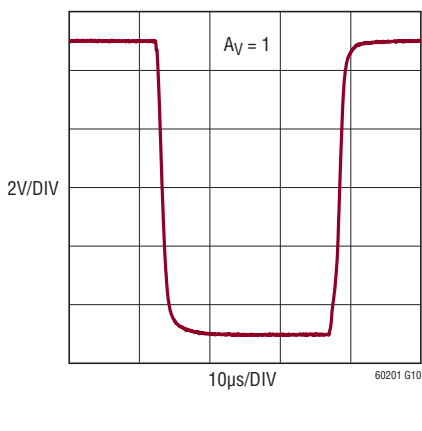

**Slew Rate vs Temperature (5V Step)**

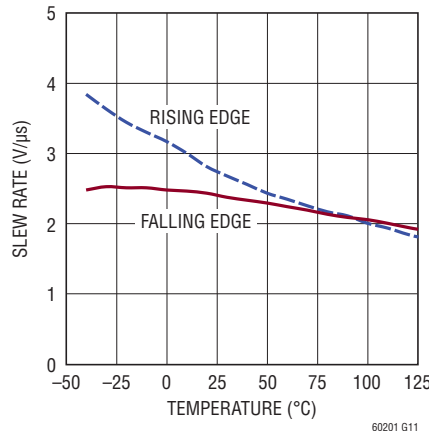

**Slew Rate vs Temperature (10V Step)**

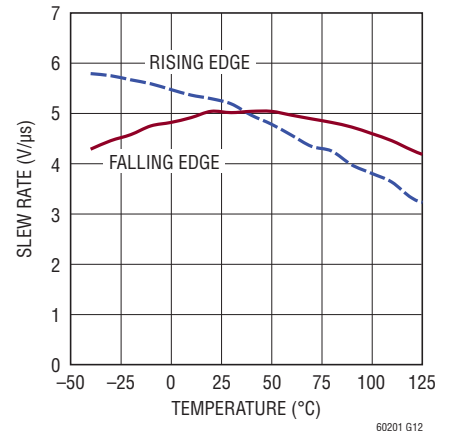

**TYPICAL PERFORMANCE CHARACTERISTICS**

$T_A = 25^\circ\text{C}$ ,  $V_S = \pm 15\text{V}$ ,  $R_L = 100\text{k}\Omega$  unless otherwise specified.

**Slew Rate vs Input Step**

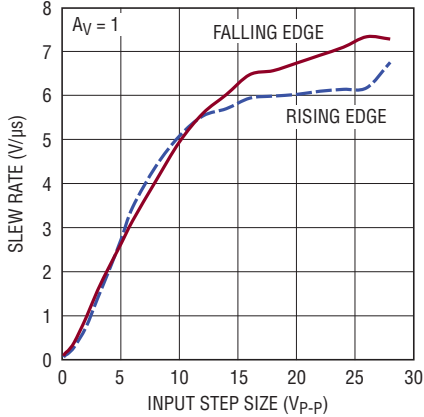

**Small-Signal Transient Response**

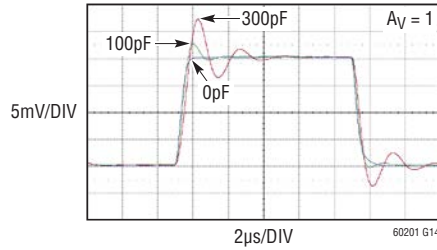

**Overshoot vs Capacitive Load**

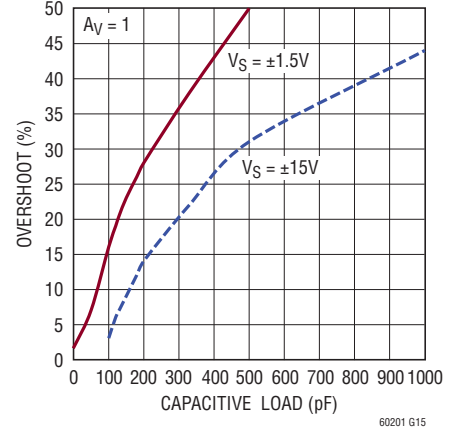

**PSRR vs Frequency**

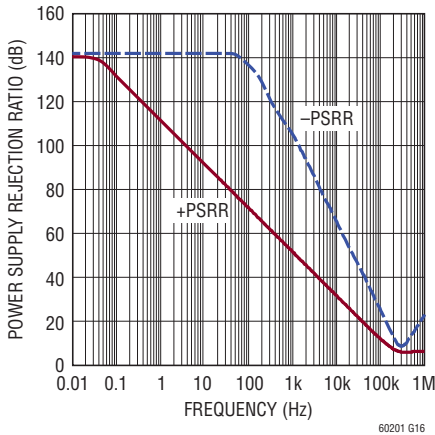

**CMRR vs Frequency**

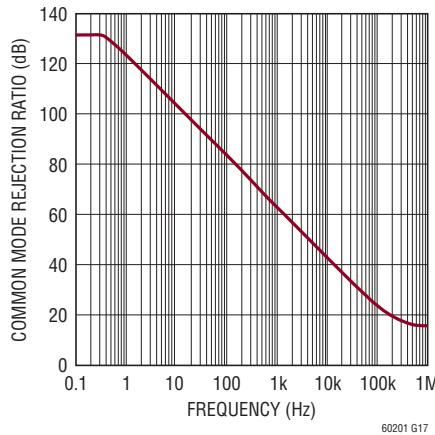

**Open-Loop Gain and Phase vs Frequency**

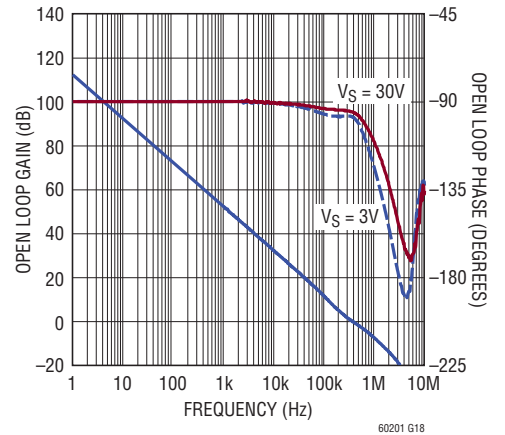

**Gain vs Frequency**

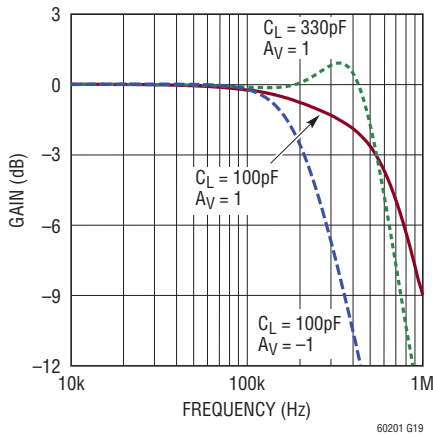

**Open Loop Gain vs Load**

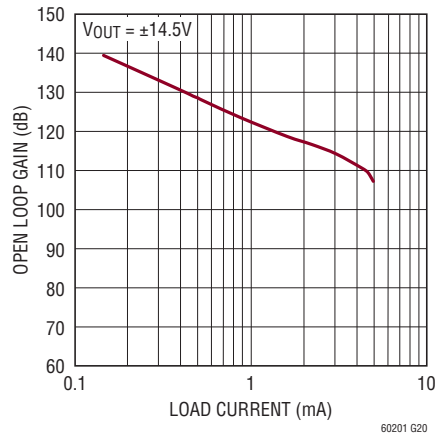

**Output Impedance vs Frequency**

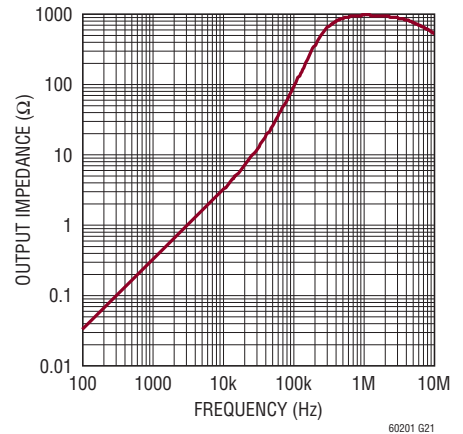

## TYPICAL PERFORMANCE CHARACTERISTICS

$T_A = 25^\circ\text{C}$ ,  $V_S = \pm 15\text{V}$ ,  $R_L = 100\text{k}\Omega$  unless otherwise specified.

### Supply Current vs Supply Voltage

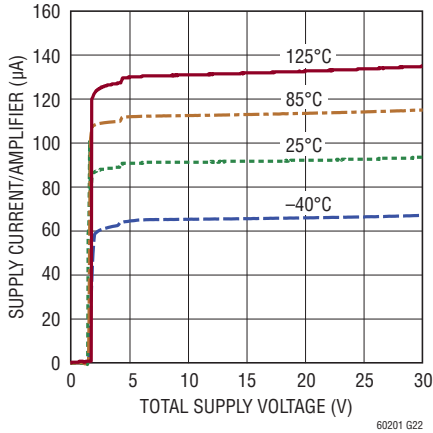

60201 G22

### Shutdown Supply Current vs Temperature

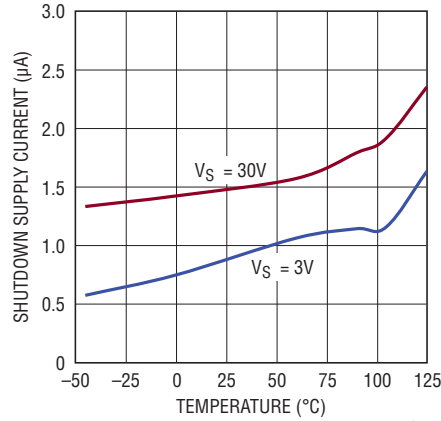

60201 G23

### Start-Up Response

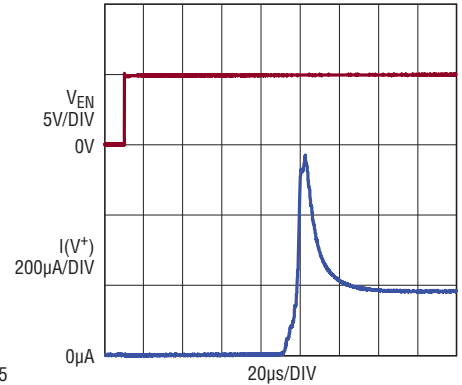

60201 G24

### Enable/Disable Response

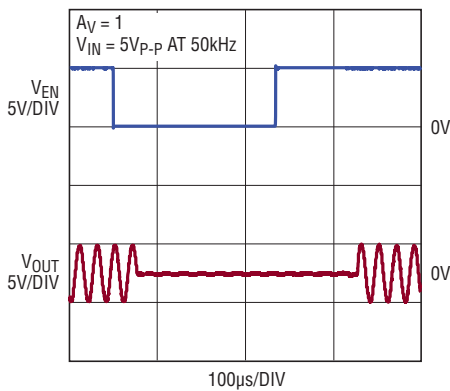

60201 G24

### Output Saturation Voltage vs Sink Current (Output Low)

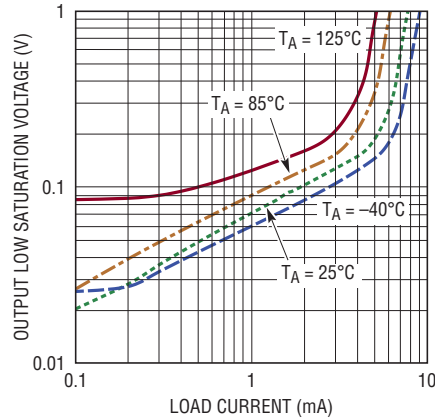

60201 G26

### Output Saturation Voltage vs Source Current (Output High)

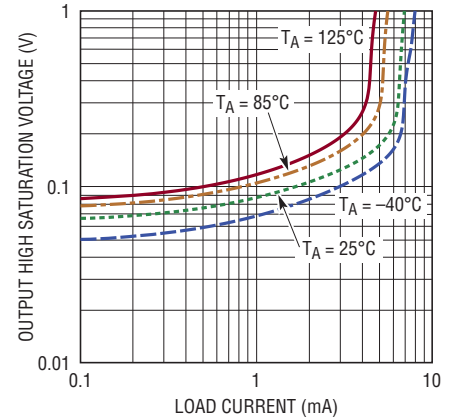

60201 G27

### Crosstalk vs Frequency

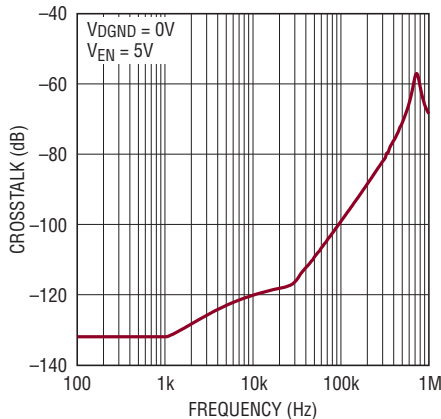

60201 G28

### Positive Output Overdrive Recovery

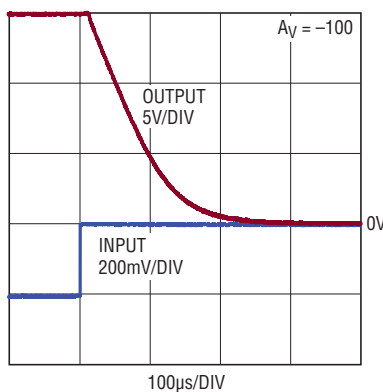

60201 G29

### Negative Output Overdrive Recovery

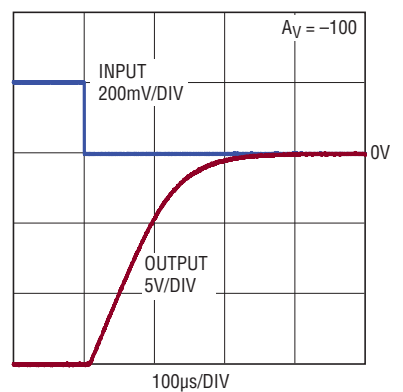

60201 G30

60201fa

## PIN FUNCTIONS

**OUT:** Amplifier Output.

**-IN:** Inverting Input of the Amplifier.

**+IN:** Noninverting Input of the Amplifier.

**V<sup>-</sup>:** Negative Power Supply. A bypass capacitor should be used between supply pins and ground. Additional bypass capacitance may be used between the power supply pins.

**DGND (LT6020-1 Only):** Reference for EN Pin. It is normally tied to ground. DGND must be in the range from V<sup>-</sup> to V<sup>+</sup> -3V. If grounded, V<sup>+</sup> must be  $\geq 3V$ . The EN pin threshold is specified with respect to the DGND pin. DGND cannot be floated.

**EN (LT6020-1 Only):** Enable Input. This pin must be connected high, normally to V<sup>+</sup>, for the amplifiers to be functional. EN is active high with the threshold approximately two diodes above DGND. EN cannot be floated. The shutdown threshold voltage is specified with respect to the voltage on the DGND pin.

**V<sup>+</sup>:** Positive Power Supply. A bypass capacitor should be used between supply pins and ground. Additional bypass capacitance may be used between the power supply pins.

## SIMPLIFIED SCHEMATIC

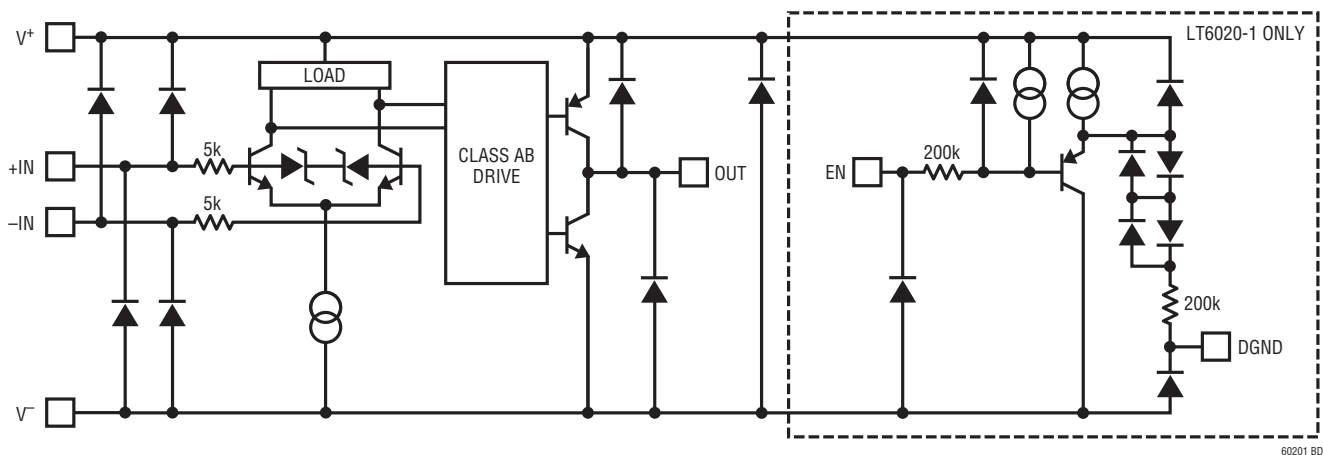

## APPLICATIONS INFORMATION

### Preserving Low Power Operation

The proprietary circuitry used in the LT6020 provides an excellent combination of low power, low offset and enhanced slew rate. Normally an amplifier with higher supply current would be required to achieve this combination of slew rate and precision. Special care must be taken to ensure that the low power operation is preserved.

The choice of feedback resistor values impacts several op-amp parameters as noted in the feedback components section. It should also be noted that the output of the amplifier must drive this network. For example, in a gain of two with a total feedback resistance of 10k $\Omega$  and an output voltage of 14V, the amplifier's output will need to supply 1.4mA of current. This current will ultimately come from a supply.

## APPLICATIONS INFORMATION

The supply current of the LT6020 increases with large differential input voltages. Normally, this does not impact the low power nature of the LT6020 because the amplifier is forcing the two inputs to be at the same potential. Conditions which cause differential input voltage to appear should be avoided in order to preserve the low power dissipation of the LT6020. This includes but is not limited to: operation as a comparator, excessive loading on the output and overdriving the input.

### Enhanced Slew Rate

The LT6020 uses a proprietary input stage which provides an enhanced slew rate without sacrificing input precision specs such as input offset voltage, common mode rejection and noise. The unique input stage of the LT6020 allows the output to quickly slew to its final value when large signal input steps are applied. This enhanced slew characteristic allows the LT6020 to quickly settle the output to 0.0015% independent of input step size as shown in Figure 1. Typical micropower amplifiers cannot process large amplitude signals with this speed. As shown in the Typical Performance curves, when the LT6020 is configured in unity gain and a 10V step is applied to the input the output will slew at 5V/μs. In this same configuration, a 5V input step will slew the output at 2.4V/μs. Furthermore, a 0.7V input step will lower the slew rate to 0.2V/μs. Note that for these

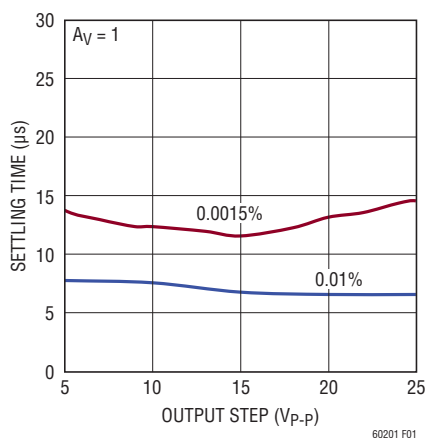

Figure 1. Settling Time Is Essentially Flat

smaller inputs the LT6020 slew rate approaches the slew rate more common in traditional micropower amplifiers.

### Input Bias Current

The design of the input stage of the LT6020 is more sophisticated than that shown in the Simplified Schematic. It uses both NPN and PNP input differential amplifiers to sense the input differential voltage. As a result the specified input bias current can flow in or out of the input pins.

### Multiplexer Applications/High Dynamic Input Impedance

The LT6020 has features which make it desirable for multiplexer applications, such as the application featured on the back page of this data sheet. When the channels of the multiplexer are cycled, the output of the multiplexer can produce large voltage transitions. Normally, bipolar amplifiers have back-to-back diodes between the inputs, which will turn on when the input transient voltage exceeds 0.7V, causing a large transient current to be conducted from the amplifier output stage back into the input driving circuitry. The driving circuitry then needs to absorb this current and settle before the amplifier can settle. The LT6020 uses 5.5V Zener diodes to protect its inputs which dramatically increases its input impedance with input steps as large as 5V.

### Achieving Rail-to-Rail Operation without Rail-to-Rail Inputs

The LT6020 output is able to swing close to each power supply rail, but the input stage is limited to operating between  $V^- + 1.2V$  and  $V^+ - 1.4V$ . For many inverting applications and noninverting gain applications, this is largely inconsequential. Figure 2 shows the basic op amp configurations, what happens to the op amp inputs and whether or not the op amp must have rail-to-rail inputs.

The circuit of Figure 3 shows an extreme example of the inverting case. The input voltage at the 100k resistor can swing  $\pm 13.5V$  and the LT6020 will output an inverted,

## APPLICATIONS INFORMATION

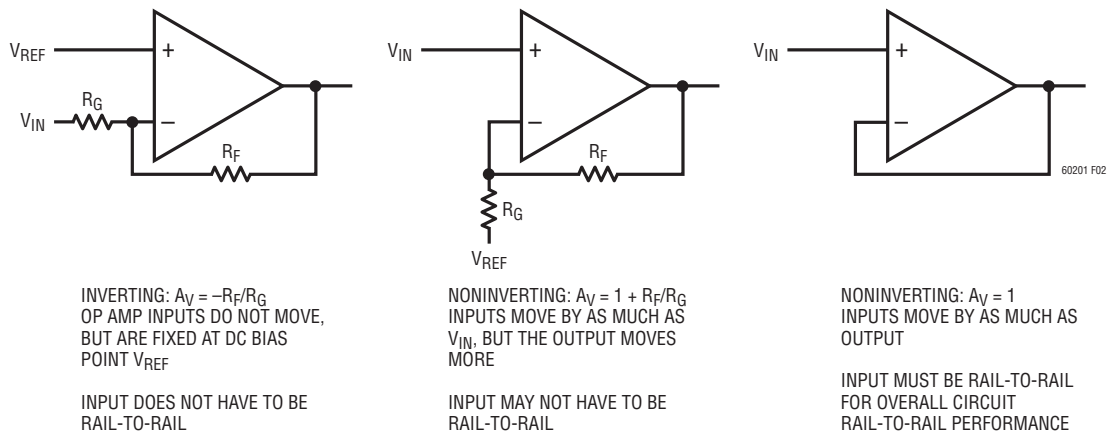

Figure 2. Some Op Amp Configurations Do Not Require Rail-to-Rail Inputs to Achieve Rail-to-Rail Outputs

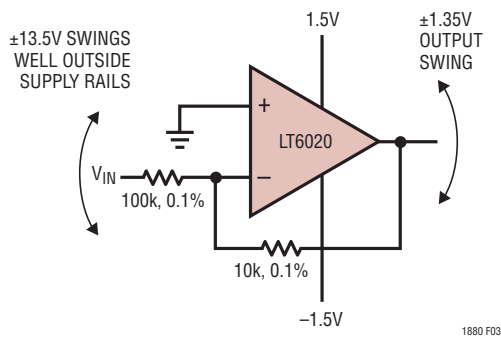

Figure 3. Extreme Inverting Case: Circuit Operates Properly with Input Voltage Swing Well Outside Op Amp Supply Rails

divided-by-ten version of the input voltage. The output accuracy is limited by the resistors to 0.2%. Output referred, this error becomes 2.7mV. The 30 $\mu$ V input offset voltage contribution, plus the additional error due to input bias current times the  $\sim$ 10k effective source impedance, contribute only negligibly to error.

### Phase Inversion

The LT6020 input stage is limited to operating between  $V^- + 1.2V$  and  $V^+ - 1.4V$ . Exceeding this common mode range will cause the open loop gain to drop significantly. For a unity gain amplifier, the output roughly tracks the input well beyond

the specified input voltage range as shown in Figure 4. However the open loop gain is significantly reduced. While the output roughly tracks the input, the reduction in open loop gain degrades the accuracy of the LT6020 in this region. Exceeding the input common mode range also causes a significant increase in input bias current as shown in Figure 5. The output of the LT6020 is guaranteed over the specified temperature range not to phase invert as long as the input voltage does not exceed the supply voltage.

### Preserving Input Precision

Preserving the input accuracy of the LT6020 requires that the application circuit and PC board layout do not

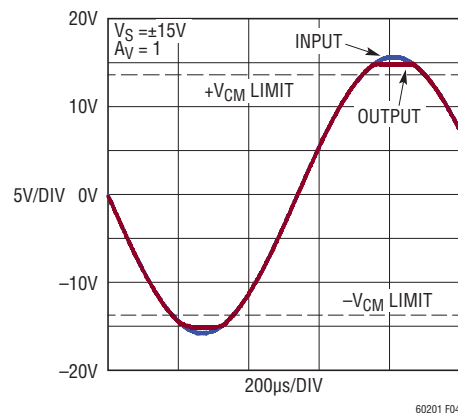
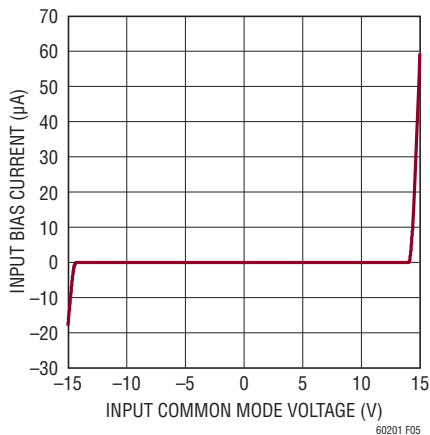

Figure 4. No Phase Inversion

## APPLICATIONS INFORMATION



**Figure 5. Increased  $I_b$  Beyond VICM**

introduce errors comparable to or greater than the offset of the amplifiers. Temperature differentials across the input connections can generate thermocouple voltages of tens of microvolts so the connections of the input leads should be short, close together and away from heat dissipating components. Air currents across the board can also generate temperature differentials.

As is the case with all amplifiers, a change in load current changes the finite open loop gain. Increased load current reduces the open loop gain as seen in the Typical Performance Characteristics section. This results in a change in input offset voltage. Under large signal conditions with load currents of  $\pm 2\text{mA}$  the effective change in input error is just tens of microvolts. In precision applications it is important to consider amplifier loading when selecting feedback resistor values as well as the loads on the device.

### Feedback Components

Care must be taken to ensure that the pole formed by the feedback resistors and the parasitic capacitance at the inverting input does not degrade stability. For example, in a gain of +2 configuration, with 100k feedback resistors and a poorly designed circuit board layout with parasitic capacitance of 10pF (amplifier + PC board) at the amplifier's inverting input will cause the amplifier to have poor phase margin due to a pole formed at 320kHz. An additional capacitor of 10pF across the feedback resistor as shown in Figure 6 will eliminate any ringing or oscillation.

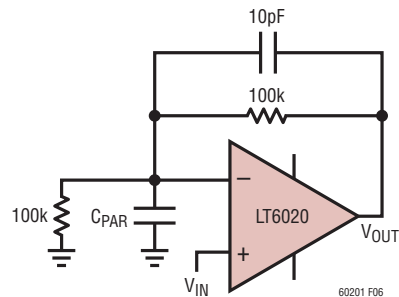

**Figure 6. Stability with Parasitic Input Capacitance**

### Capacitive Loads

The LT6020 can drive capacitive loads up to 100pF in unity gain. The capacitive load driving capability increases as the amplifier is used in higher gain configurations. A small series resistance between the output and the load will further increase the amount of capacitance that the amplifier can drive.

### Shutdown Operation (LT6020-1)

The LT6020-1 shutdown function has been designed to be easily controlled from single supply logic or microcontrollers. To enable the LT6020-1 when  $V_{DGND} = 0\text{V}$  the enable pin must be driven above 1.7V. Conversely, to enter the low power shutdown mode the enable pin must be driven below 0.8V. In a  $\pm 15\text{V}$  dual supply application where  $V_{DGND} = -15\text{V}$ , the enable pin must be driven above  $\sim -13.3\text{V}$  to enable the LT6020-1. If the enable pin is driven below  $-14.2\text{V}$  the LT6020-1 enters the low power shutdown mode. Note that to enable the LT6020-1 the enable pin voltage can range from  $-13.3\text{V}$  to 15V whereas to disable the LT6020-1 the enable pin can range from  $-15\text{V}$  to  $-14.2\text{V}$ . Figure 7 shows examples of enable pin control. While in shutdown, the outputs of the LT6020-1 are high impedance.

The LT6020-1 is typically capable of coming out of shutdown within 100µs. This is useful in power sensitive applications where duty cycled operation is employed such as wireless mesh networks. In these applications the system is in low power mode the majority of the time, but then needs to wake up quickly and settle for an acquisition before being powered back down to save power.

## APPLICATIONS INFORMATION

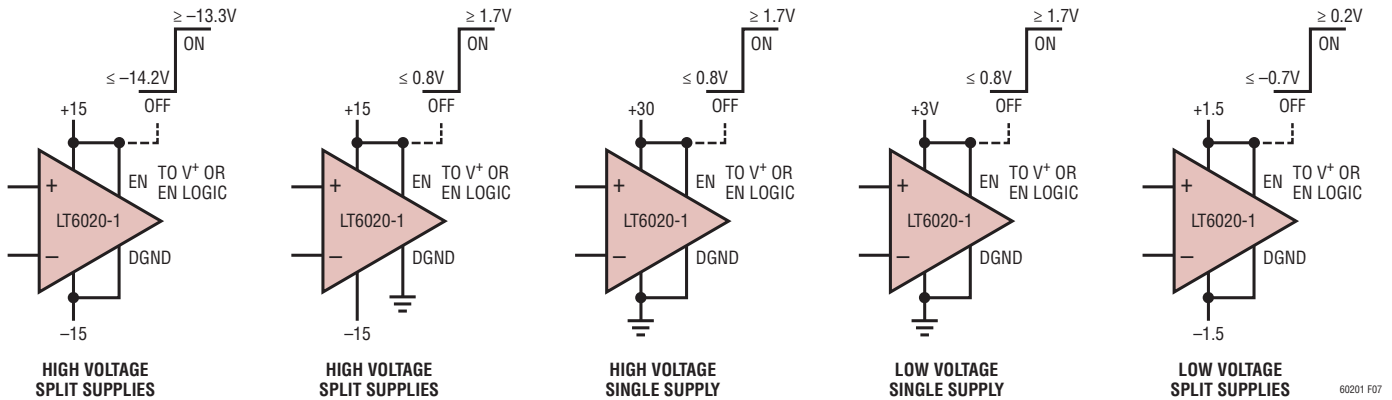
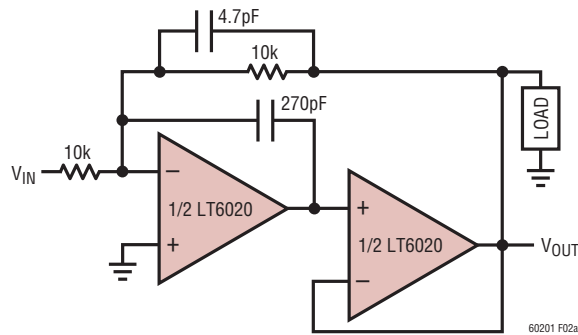

Figure 7. LT6020-1 Enable Pin Control Examples

## TYPICAL APPLICATIONS

### High Open-Loop Gain Composite Amplifier



Parallel Amplifiers Achieves  $32\text{nV}/\sqrt{\text{Hz}}$  Noise, Doubles Output Drive and Lowers Offset

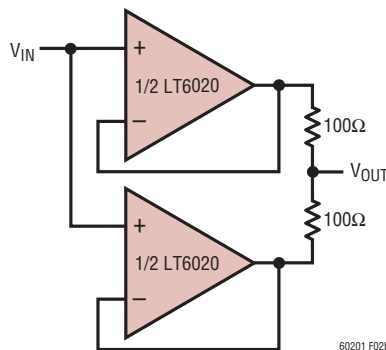

## PACKAGE DESCRIPTION

Please refer to <http://www.linear.com/designtools/packaging/> for the most recent package drawings.

**DD Package**  
**8-Lead Plastic DFN (3mm × 3mm)**  
 (Reference LTC DWG # 05-08-1698 Rev C)

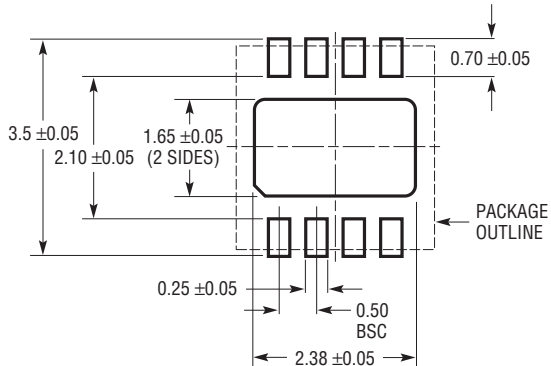

RECOMMENDED SOLDER PAD PITCH AND DIMENSIONS  
 APPLY SOLDER MASK TO AREAS THAT ARE NOT SOLDERED

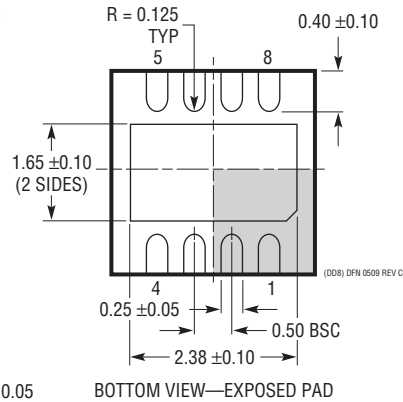
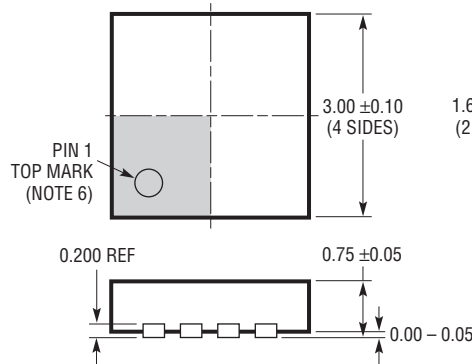

- NOTE:
1. DRAWING TO BE MADE A JEDEC PACKAGE OUTLINE MO-229 VARIATION OF (WEED-1)
  2. DRAWING NOT TO SCALE
  3. ALL DIMENSIONS ARE IN MILLIMETERS
  4. DIMENSIONS OF EXPOSED PAD ON BOTTOM OF PACKAGE DO NOT INCLUDE MOLD FLASH. MOLD FLASH, IF PRESENT, SHALL NOT EXCEED 0.15mm ON ANY SIDE
  5. EXPOSED PAD SHALL BE SOLDER PLATED
  6. SHADED AREA IS ONLY A REFERENCE FOR PIN 1 LOCATION ON TOP AND BOTTOM OF PACKAGE

# PACKAGE DESCRIPTION

Please refer to <http://www.linear.com/designtools/packaging/> for the most recent package drawings.

## DD Package 10-Lead Plastic DFN (3mm × 3mm) (Reference LTC DWG # 05-08-1699 Rev C)

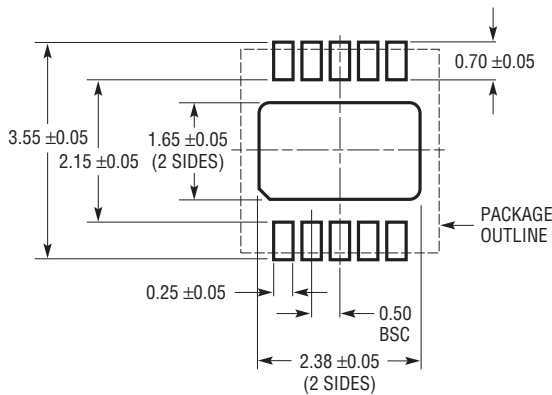

### RECOMMENDED SOLDER PAD PITCH AND DIMENSIONS

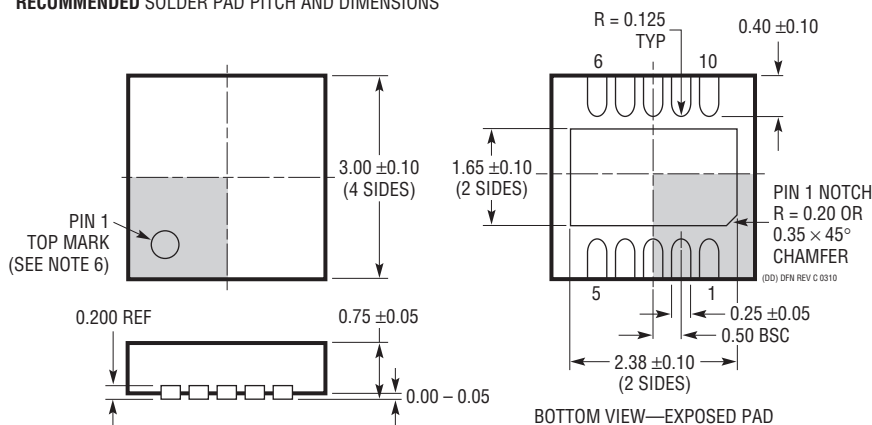

**NOTE:**

1. DRAWING TO BE MADE A JEDEC PACKAGE OUTLINE M0-229 VARIATION OF (WEED-2). CHECK THE LTC WEBSITE DATA SHEET FOR CURRENT STATUS OF VARIATION ASSIGNMENT
2. DRAWING NOT TO SCALE
3. ALL DIMENSIONS ARE IN MILLIMETERS
4. DIMENSIONS OF EXPOSED PAD ON BOTTOM OF PACKAGE DO NOT INCLUDE MOLD FLASH. MOLD FLASH, IF PRESENT, SHALL NOT EXCEED 0.15mm ON ANY SIDE
5. EXPOSED PAD SHALL BE SOLDER PLATED
6. SHADED AREA IS ONLY A REFERENCE FOR PIN 1 LOCATION ON THE TOP AND BOTTOM OF PACKAGE

## PACKAGE DESCRIPTION

Please refer to <http://www.linear.com/designtools/packaging/> for the most recent package drawings.

**MS8 Package**  
**8-Lead Plastic MSOP**  
 (Reference LTC DWG # 05-08-1660 Rev G)

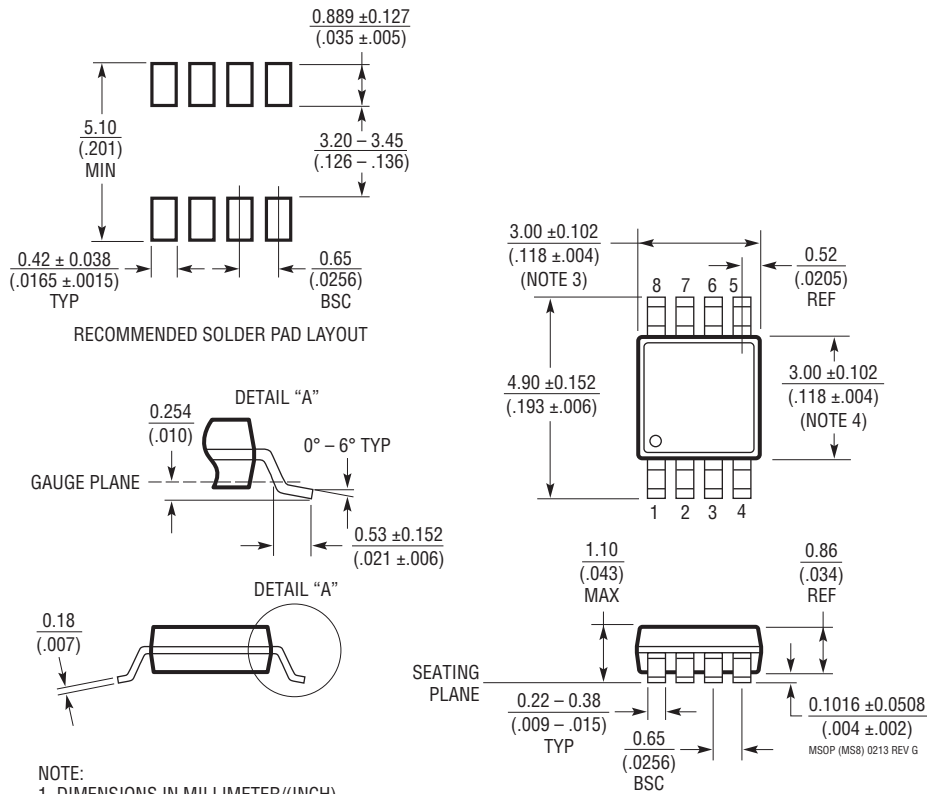

- NOTE:
1. DIMENSIONS IN MILLIMETER/(INCH)
  2. DRAWING NOT TO SCALE
  3. DIMENSION DOES NOT INCLUDE MOLD FLASH, PROTRUSIONS OR GATE BURRS. MOLD FLASH, PROTRUSIONS OR GATE BURRS SHALL NOT EXCEED 0.152mm (.006") PER SIDE
  4. DIMENSION DOES NOT INCLUDE INTERLEAD FLASH OR PROTRUSIONS. INTERLEAD FLASH OR PROTRUSIONS SHALL NOT EXCEED 0.152mm (.006") PER SIDE
  5. LEAD COPLANARITY (BOTTOM OF LEADS AFTER FORMING) SHALL BE 0.102mm (.004") MAX

## REVISION HISTORY

REV	DATE	DESCRIPTION	PAGE NUMBER
A	04/14	Added MS8 package version.	All

## TYPICAL APPLICATION

### Gain of 11 Instrumentation Amplifier

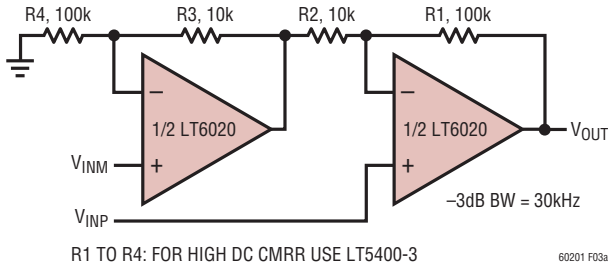

### Improved Load Drive Capability

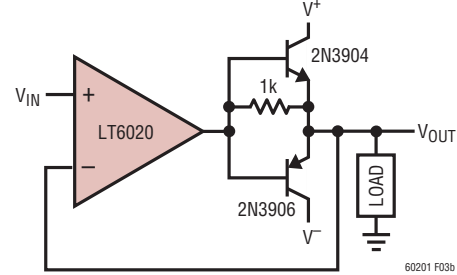

### ±13.6V Input Range MUX Buffer

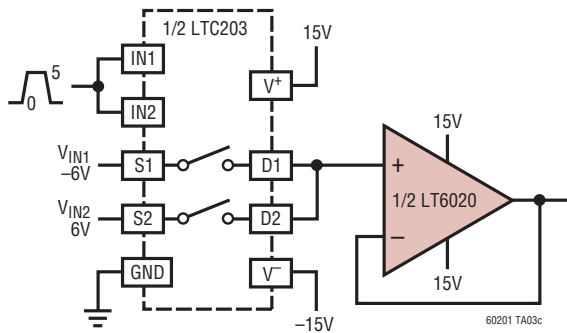

### MUX Buffer Response, 12V Step

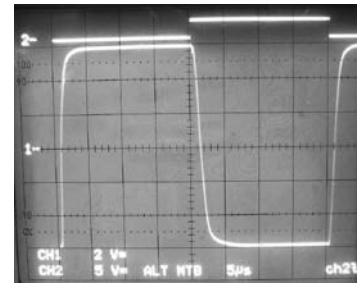

## RELATED PARTS

PART NUMBER	DESCRIPTION	COMMENTS
<a href="#">LTC6256</a>	6.5MHz, 65µA RRIO Op Amp	$V_{OS}$ : 350µV, GBW: 6.5MHz, SR: 1.8V/µs, $e_n$ : 20nV/√Hz, $I_S$ : 65µA
<a href="#">LT1352</a>	3MHz, 200V/µs Op Amp	$V_{OS}$ : 600µV, GBW: 3MHz, SR: 200V/µs, $e_n$ : 14nV/√Hz, $I_S$ : 330µA
<a href="#">LT1492</a>	5MHz, 3V/µs Op Amp	$V_{OS}$ : 180µV, GBW: 5MHz, SR: 3V/µs, $e_n$ : 16.5nV/√Hz, $I_S$ : 550µA
<a href="#">LTC5800</a>	SmartMesh® Wireless Sensor Network IC	Wireless Mesh Networks
<a href="#">LT5400</a>	Quad Matched Resistor Network	0.01% Matching

## X-ON Electronics

Largest Supplier of Electrical and Electronic Components

*Click to view similar products for [Precision Amplifiers](#) category:*

*Click to view products by [Analog Devices](#) manufacturer:*

Other Similar products are found below :

[OPA4187IRUMT](#) [OPA202IDGKT](#) [514327X](#) [561681F](#) [647876R](#) [5962-9080901MCA\\*](#) [MAX410CPA](#) [MAX44241AUK+T](#) [LT6230IS6#TR](#)  
[OP227GN#PBF](#) [LT6020IDD-1#PBF](#) [LT6023IDD#PBF](#) [LT6013AIDD#PBF](#) [LT6237IMS8#PBF](#) [LT1124CS8#TR](#) [LT1215CS8#TRPBF](#)  
[ADA4622-1ARZ-R7](#) [NCS21871SQ3T2G](#) [NCS21871SN2T1G](#) [NCV21871SQ3T2G](#) [NCV21871SN2T1G](#) [AD8538WAUJZ-R7](#)  
[NCS21912DMR2G](#) [MCP6V82-EMS](#) [MCP6V92-EMS](#) [TLC27L7CP](#) [TLE2022MD](#) [TLV2473CDR](#) [MCP6V34-E/ST](#) [MCP6V84-EST](#)  
[MCP6V94-EST](#) [LT1014DDWR](#) [5962-89641012A](#) [5962-8859301M2A](#) [5962-89801012A](#) [5962-9452101M2A](#) [LMC6064IN](#) [LT1013DDR](#)  
[TL034ACDR](#) [TLC2201AMDG4](#) [TLC274MDRG4](#) [TLE2021QDRG4Q1](#) [TLE2024BMDWG4](#) [AD8691WAUJZ-R7](#) [AD8629TRZ-EP-R7](#)  
[AD8604ARQZ](#) [TS507IYLT](#) [MAX4239ATT+T](#) [MAX4238AUT+T](#) [MAX4168EPD](#)