

THIS DOCUMENT IS SUBJECT TO CHANGE WITHOUT NOTICE. IT IS CONFIDENTIAL AND A PROPERTY OF AMPHENOL LTW. DISCLOSURE TO THIRD PARTY HAS TO BE AUTHORIZED BY AMPHENOL LTW.

REV.	ECN NO.	DATE	SIGN	DESCRIPTION
B	C220467	2022/03/29	Vicky	△B X2
C	C221118	2022/07/26	Vicky	△C X1
D	C230128	2023/02/09	Ruru	△D X1

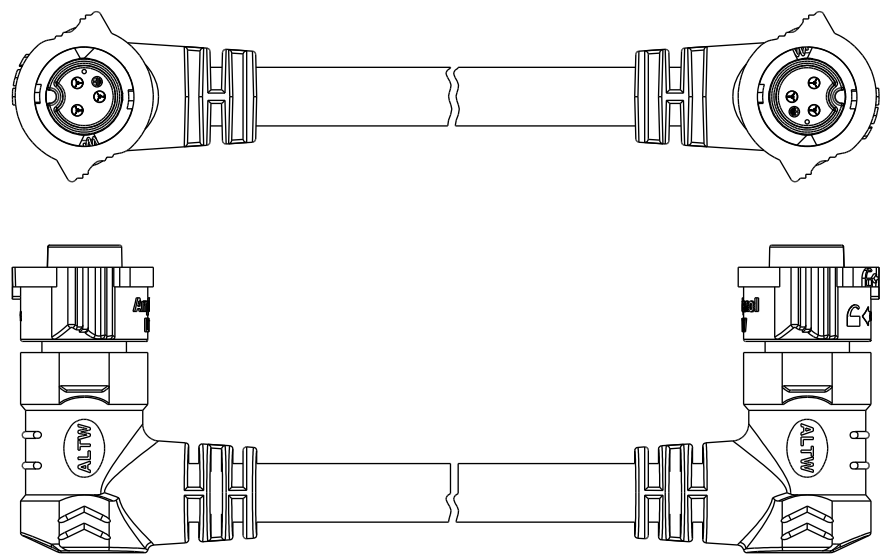
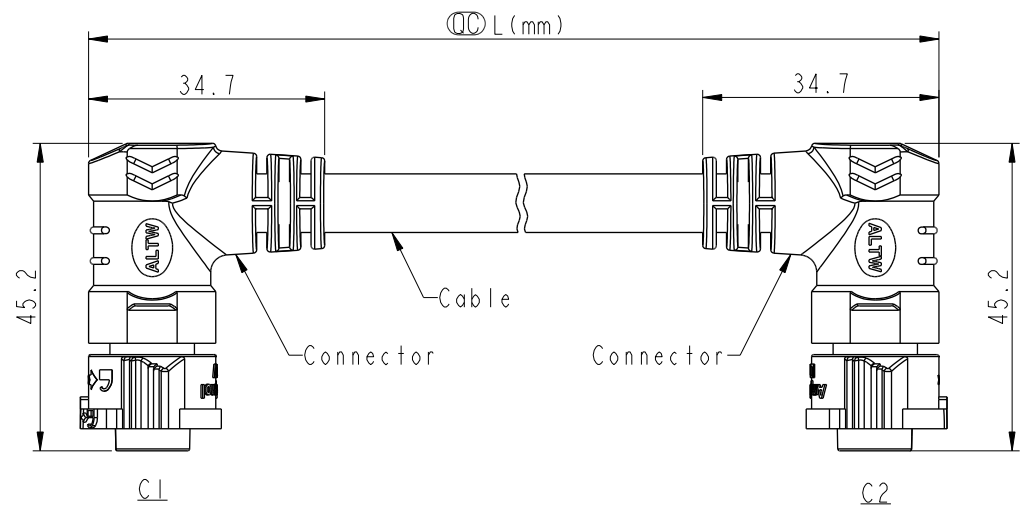

- △ Note:
- * RoHS Compliant
 - * Ⓞ Important dimension
 - △ * Waterproof rate: IP68, mated 1m/24h
 - * Connector
 - Housing: Thermoplastic, Black
 - Pin: Copper alloy, Gold plated
 - O-Ring: Rubber, Dark gray
 - Nut: Thermoplastic, Black
 - Outer Mold: Thermoplastic, Black
 - * Cable: SJTW, PVC Jacket, Black
 - * Cable length tolerance:

0.5M < L	≤	1M	: +60/-0 mm
1M < L	≤	3M	: +120/-0 mm
3M < L	≤	5M	: +160/-0 mm
5M < L	≤	10M	: ±100 mm
10M < L	≤	20M	: ±200 mm
20M < L	≤	30M	: ±300 mm
30M < L	≤	99M	: ±500 mm

UNIT: mm		
TOLERANCE	±0.5mm	

TITLE ACC, XLOK, B-10A, DB-ENDED FF		
SCALE 1:2	SIZE A4	SHEET 1 OF 2
REV. D	WC-REV. A.5	Ⓞ: Inspection item

Amphenol LTW
安費諾亮泰企業股份有限公司

ITEM NO.	DRAWN BY Vicky	DATE 2020-01-20
DWG NO. AB-BBXXBR-BBBR-QEXXX	CHECKED BY Rita	DATE 2020-01-20
CUSTOMER ALTW	APPROVED BY Max	DATE 2020-01-20



THIS DOCUMENT IS SUBJECT TO CHANGE WITHOUT NOTICE. IT IS CONFIDENTIAL AND A PROPERTY OF Amphenol LTW. DISCLOSURE TO THIRD PARTY HAS TO BE AUTHORIZED BY Amphenol LTW.

3P	PVC	8.6	16	AB-BB03BR-BBBR-QEXXX
2P		8.2		AB-BB02BR-BBBR-QEXXX
Contacts	Cable Jacket	Cable OD	AWG	Item No.

AB-BB XX BR-BBBR-QE XXX

 XX: No. Of Pin

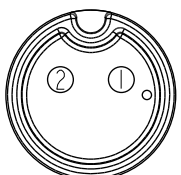
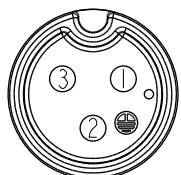
XXX: 0.5~99Meters
 A05: 0.5 Meter
 001: 01 Meter
 002: 02 Meters
 :
 099: 99 Meters

Pin Out	2 White 1 Black	白 黑	3 Green 2 White 1 Black	綠 白 黑
	Pin #	Wire	Pin #	Wire
C1 & C2				
	2P		3P	

Pin Assignments Front View

UNIT:mm		TITLE	ACC, XLOK, B-10A, DB-ENDED FF	
TOLERANCE	±0.5mm	SCALE	1:2	SIZE A4
		REV.	D	WC-REV. A.5
			SHEET 2 OF 2	QC: Inspection item

Amphenol LTW
 安費諾亮泰企業股份有限公司

ITEM NO	DRAWN BY	DATE
	Vicky	2020-01-20
DWG NO	CHECKED BY	DATE
AB-BBXXBR-BBBR-QEXXX	Rita	2020-01-20
CUSTOMER	APPROVED BY	DATE
ALTW	Max	2020-01-20

X-ON Electronics

Largest Supplier of Electrical and Electronic Components

Click to view similar products for [Sensor Cables / Actuator Cables](#) category:

Click to view products by [Amphenol](#) manufacturer:

Other Similar products are found below :

[60963](#) [60964](#) [M83513/19-F01CP](#) [703000D02F2002](#) [703000D02F300](#) [703001D02F1201](#) [704000D02F120](#) [802027213811-1](#) [84914-0235](#)
[883030A09M050](#) [884031A09M005](#) [8R4006A18M010](#) [1200980008](#) [1200980031](#) [1211810021](#) [1400637](#) [1401201](#) [1401348](#) [1405278](#)
[1408644/94F/8](#) [1455311](#) [1513981](#) [1550119](#) [1554212](#) [1R3006A20A120G](#) [1R4004A17A120](#) [1R4006A20A1202](#) [1R4006A39M005](#) [2289297-6](#)
[8R3006A16A1203](#) [8R5E36E03M020](#) [2R7004A20F060](#) [301000A01F200](#) [301002A01F120](#) [2289297-1](#) [2289297-8](#) [2289297-9](#)
[302000A01F120](#) [CONM6A-S2](#) [332021A01F200](#) [3R1006A20F030](#) [3R9006A20A1201](#) [403001A10M040](#) [4030P1A10M040](#) [41-01023](#)
[MBCC-412](#) [1R3G06A20A120](#) [543031A10M010](#) [884030A09M100](#) [883033A09M020](#)