

# Amphenol

# A-Line<sup>®</sup> Industrial Connectors

SINE Systems \* Pyle Connectors Corporation



# SINE

## A-Line®... Low Profile Heavy-Duty Performance

**A-Line®** represents The Sine Companies, Inc. commitment to quality and performance regarding the manufacturing of heavy-duty, attachable, metal shell, multi-pin, electrical connectors.

A-Line is designed for commercial and industrial environments requiring a low profile bayonet coupling style connector for heavy-duty control and signal applications. A comprehensive selection of insert arrangements and accessory hardware configurations are featured to accommodate heavy-duty, commercial wire and cable. Common applications include automation machine tool, robotics, instrumentation, process control, material handling, test, measurement and audio.

A-Line is manufactured in accordance with military specifications, MIL-C-83723 Series I and MIL-C-26482 Series II regarding compatibility and conformance. Enhancements are featured which permit the A-Line to effectively address the rugged conditions of the industrial workplace.





## Contents

Features / Benefits	3
Insert Configuration	5
Insert Gender /	
Hardware Style	7
Product Ordering Guide	9
Dimensional Information	
- Plug Connectors	11
- Receptacle Connectors	13
- Mounting Adapters	15
Accessories	16
Tools and	
Replacement Contacts	17
Engineering Data	19
Cable Information	20
Product Information	21

\* Sine has made every effort to ensure that the information contained in this catalog is accurate at the time of publication. Specifications or information stated in this publication are subject to change without notice.

## Features / Benefits

**A-Line** multi-pin, circular, metal shell, control/signal connectors are heavy-duty environmental grade plugs and receptacles that meet the demands of many industries.

Its one piece 5-keyed shell, coupling nut, cable adapter and gland nut are constructed of high grade machined aluminum. All aluminum components are anodized for superior corrosion resistance.

Sine's A-Line plug shell coupling nut is a finger grip design for easy handling. The bayonet coupling system allows for twist lock quick mating onto the three stainless steel receptacle shell mounted bayonet pins. The positive locking detent upon full coupling secures the connection.

The cable adapter and gland nut feature large hex machined surfaces for damage free wrench tightening during connector assembling.

A stainless steel basketweave strain relief controls cable bend radius and pull out. The gland nut compresses a tapered grommet around the jacketed cable to seal out liquids and contaminants.

Other sealing features include a shell interface gasket, an insert cork and bottle seal membrane, insert rear wire seal grommet and a cable adapter O-ring seal. A panel mount gasket is also included. Optional environmental covers are available for additional protection when connectors are in a disconnected state.

Straight and 75 degree cable adapters provide ample wire space for easy termination and assembly.

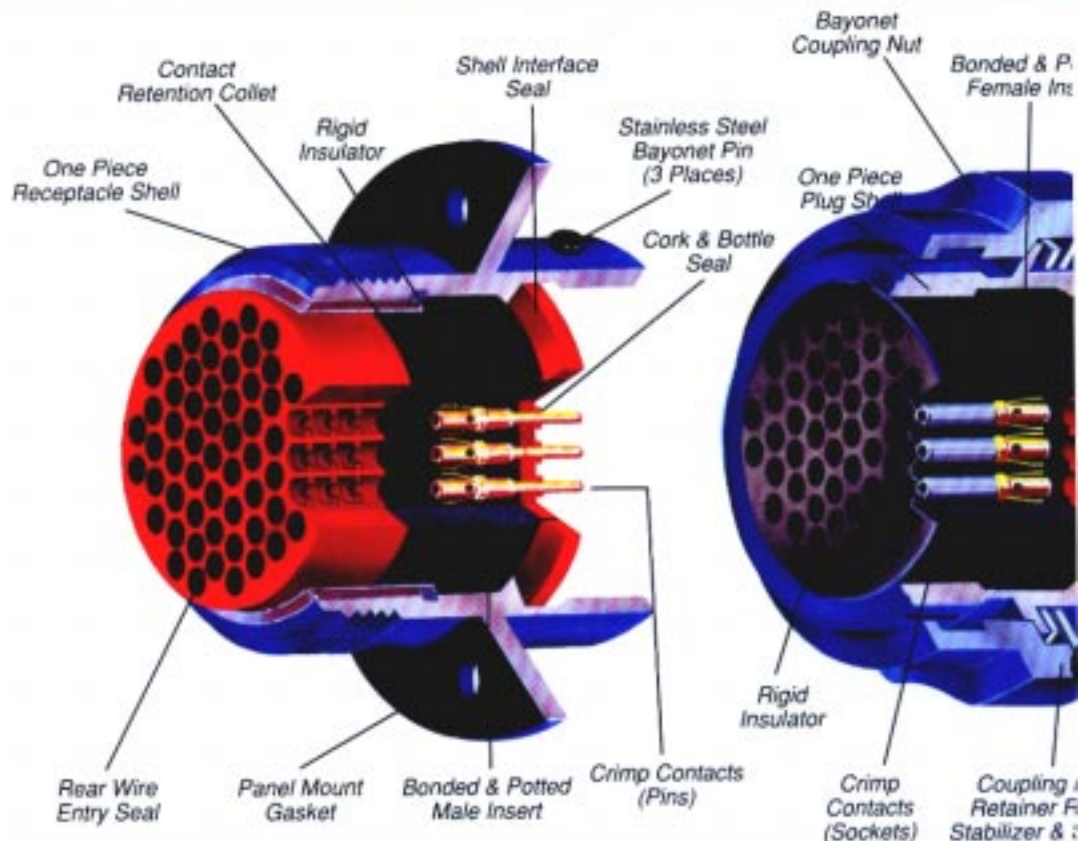

## Receptacle

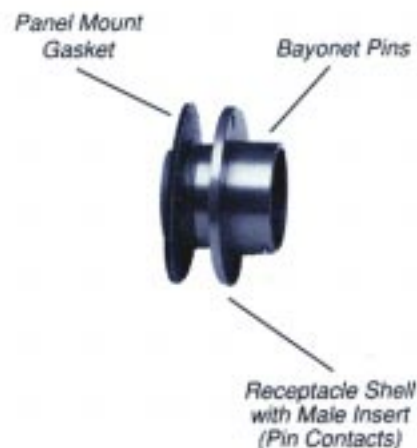

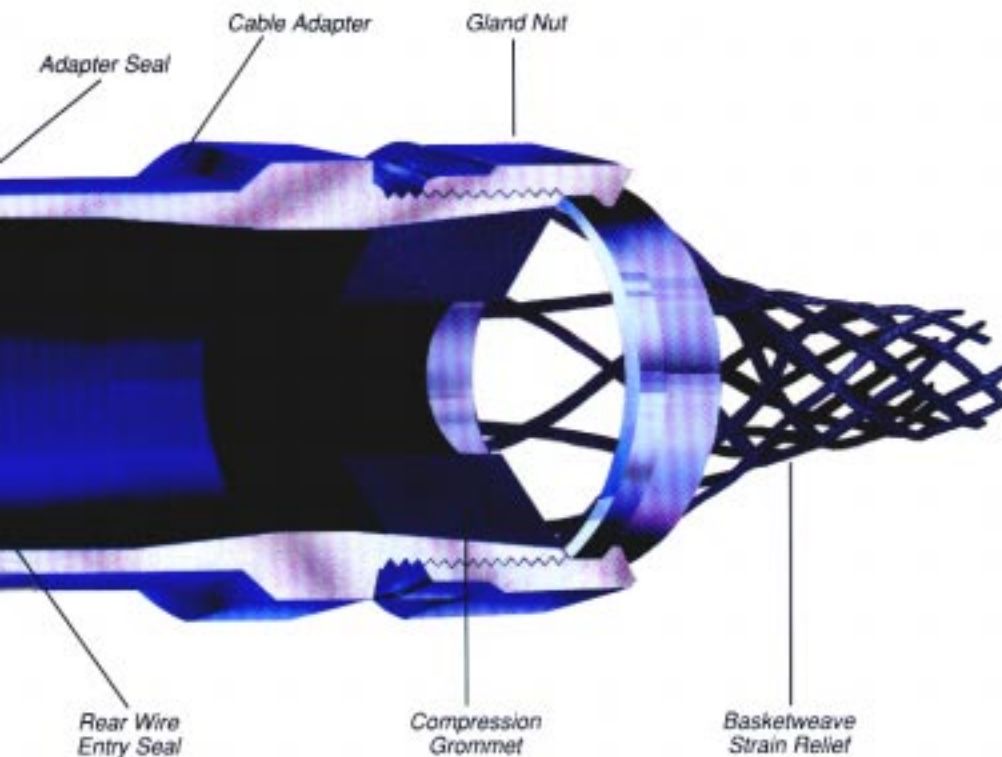

Connector inserts are of multi-wafer design and are bonded by the factory into the connector shells. The pin (male) insert features a cork and bottle interface seal that seals around the pin (male) contacts and to the face of the mating socket (female) connector insert. The rear of the pin insert incorporates a rear wire entry sealing grommet that seals around the insulated wire conductor. The center rigid dielectric material holds and stabilizes the pin contacts.

The socket (female) insert design also features a rear wire entry sealing grommet. The front rigid component holds and stabilizes the socket (female) contacts. The closed entry design of this front insulator piece protects the socket contacts from bent pins or over size probe damage. The contact locations are marked on both the front and rear of the inserts.

## Plug

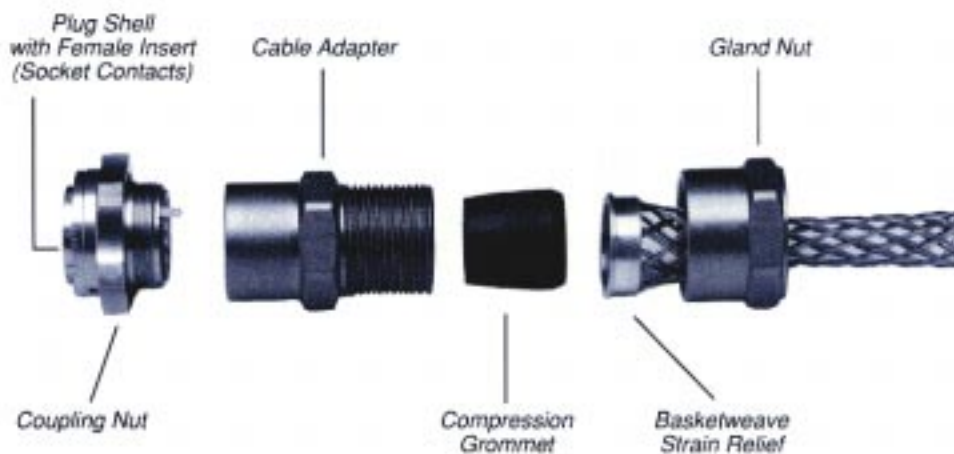

A-Line contacts are solid machined insertable removable crimp style. They are made from a high strength copper alloy and are gold plated. They are designed for high strength, durability and electrical efficiency. Socket contacts feature a protective stainless steel hood over the socket tines.

Contacts are inserted or removed at the rear of the insert. They are locked into the insert by retention collets embedded in the insert rigid insulator. All contacts are crimped with simple hand tools. The crimp is an 8-indent pattern for maximum wire retention. A long ground pin contact and shell ground clip are offered with most insert configurations (for applications requiring a ground circuit from a specified contact to the connector shell).

Note: Views shown are typical assembly of components. Components may vary depending upon insert configurations and hardware selected.

# Insert Configuration



**20 AWG**  
300V-1A AC/DC\*



3 Contact  
Shell Size 8

UNGND A503



6 Contact  
Shell Size 10

UNGND A506

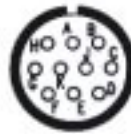

10 Contact  
Shell Size 12

UNGND A510



19 Contact  
Shell Size 14

UNGND A519



26 Contact  
Shell Size 16

UNGND A526



32 Contact  
Shell Size 18

UNGND A532



41 Contact  
Shell Size 20

UNGND A541



55 Contact  
Shell Size 22

UNGND A555



61 Contact  
Shell Size 24

UNGND A561

## Insert Voltage and Current Ratings

\*Insert Voltage Ratings are based upon the dielectric separation of contacts, dielectric strength of the insulating materials used and proven by qualification testing to the applicable requirements of MIL-C-26482.

\*Insert Current Ratings are developed and based on several factors, such as, use of com-

patible wire gage to contact size, quantity of contacts, wire insulation, temperature rating, and operating ambient temperature. The summation of the thermal effects these variables plus the contact thermal loss shall not exceed the total temperature rating of the connector (200°C, 392°F). Refer to table on page 19 for individual contact data.

The configurations shown are viewed from the front face of the male pin insert. Female socket inserts are opposite. They are not drawn to actual size. Configurations are shown in their

"normal keyed" insert rotation position. Other "alternate keyed" insert rotation positions are available for most layouts. Also, other insert configurations are available - Please consult factory.

## Contact Legend

20 ○

16 ●

12 ⊕

3 Contact  
Shell Size 12

UNGND A303  
GND A403

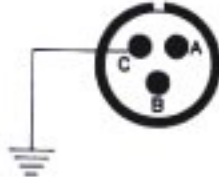

5 Contact  
Shell Size 14

UNGND A305  
GND A405

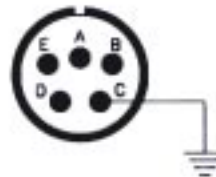

11 Contact  
Shell Size 18

UNGND A311  
GND A411

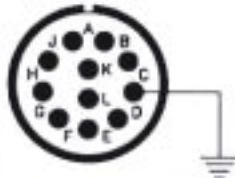

16 Contact  
Shell Size 20

UNGND A316  
GND A416

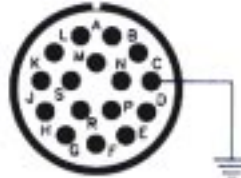

21 Contact  
Shell Size 22

UNGND A321  
GND A421

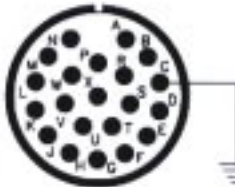

21 Contact  
Shell Size 22

GND A4FX

Special Automotive  
Specification

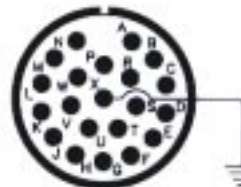

31 Contact  
Shell Size 24

UNGND A331  
GND A431

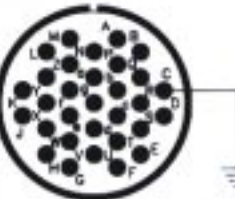

41 Contact\*\*  
Shell Size 28

UNGND A341  
GND A441

Automotive Specification  
Old Style



41 Contact\*\*  
Shell Size J28

UNGND AJ341  
GND AJ441

NEW STYLE

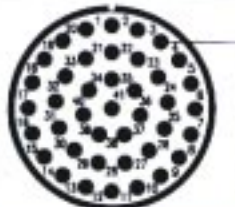

60 Contact  
Shell Size 36

UNGND A360  
GND A460

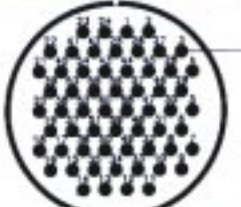

4 Contact  
Shell Size 14

UNGND A104  
GND A204

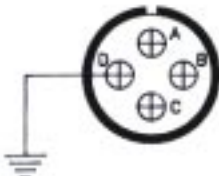

8 Contact  
Shell Size 18

UNGND A108  
GND A208

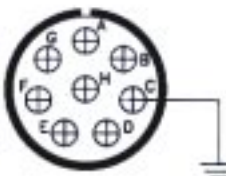

19 Contact  
Shell Size 24

UNGND A119  
GND A219



**16 AWG**  
300V-7A AC/DC\*

**12 AWG**  
300V-20A AC/DC\*

\*\* Improved design AJ341/AJ441 recommended over old style A341/A441 layout. Non-mateable to each other.

# Insert Gender / Hardware

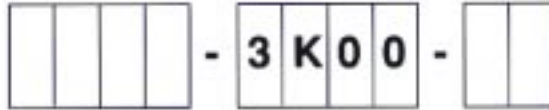

## Plug Connectors



Insert Gender	Straight Adapter	Straight/W Basketweave
Pin	3D00	3K00
Socket	4D00	4K00



Insert Gender	75 Degree Adapter	75 Degree/W Basketweave
Pin	3X00	3Y00
Socket	4X00	4Y00



Insert Gender	Dummy Adapter	Panel Mount	Conduit Adapter
Pin	3S00	3P00	3T00
Socket	4S00	4P00	4T00

Plug only (no hardware) - 3000 (pin) and 4000 (socket) designations.

## Receptacle Connectors



Insert Gender	Straight Adapter Flange/Inline	Straight/W Basketweave Flange/Inline
Pin	5D00/7D00	5K00/7K00
Socket	6D00/8D00	6K00/8K00



Insert Gender	75 Degree Adapter Flange/Inline	75 Degree/W Basketweave Flange/Inline
Pin	5X00/7X00	5Y00/7Y00
Socket	6X00/8X00	6Y00/8Y00



Insert Gender	Dummy Adapter Flange/Inline	Panel Mount	Conduit Adapter Flange/Inline
Pin	5S00/7S00	1P00	5T00/7T00
Socket	6S00/8S00	2P00	6T00/8T00

In-line receptacle only (no hardware) - 7000 (pin) and 8000 (socket) designations.

Flange mount receptacle configurations (with backend hardware) are 5 and 6 designations. Similar to panel mount.

In-line receptacle configurations (with backend hardware) are 7 and 8 designations. No mounting flange as shown.

# A-Line® Product Ordering Guide



**Sample Part No.  
A421-3Y00-A6:**

equals 21 pin, male connector kit equipped with 75° cable adapter and basketweave strain relief sized for cable O.D. of .625" to .750".

## Connector Kits

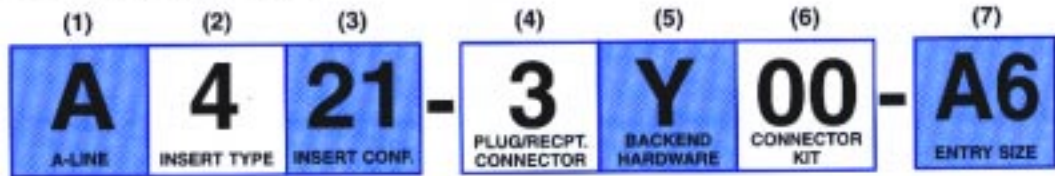

(1) A-Line	(2) Insert Type	(3) Insert Configuration	(4) Panel Mount Receptacle (1) Male (2) Female  Plug (3) Male (4) Female  In-line Flanged Receptacle (5) Male (6) Female  In-line Receptacle (7) Male (8) Female	(5) Connector Backend Hardware  (D) Straight Cable Adapter Plain  (K) Straight Cable Adapter w/ Basketweave  (T) Threaded Conduit Adapter  (X) 75° Cable Adapter  (Y) 75° Cable Adapter w/ Basketweave  (P) Panel Mount	(6) Cable Out Connector Kit Only	(7) Entry Size																																																																
	5=20 AWG 4=16 AWG (GND) 3=16 AWG 2=12 AWG (GND) 1=12 AWG	Consult Pages 5-6				<table border="1"> <thead> <tr> <th>MIN.</th> <th>MAX.</th> <th>NPT SIZE for Threaded Adapters</th> <th>ENTRY SIZE</th> </tr> </thead> <tbody> <tr><td>.062</td><td>.125</td><td>1/8</td><td>A1</td></tr> <tr><td>.125</td><td>.250</td><td>1/4</td><td>A2</td></tr> <tr><td>.250</td><td>.375</td><td>3/8</td><td>A3</td></tr> <tr><td>.375</td><td>.500</td><td>1/2</td><td>A4</td></tr> <tr><td>.500</td><td>.625</td><td></td><td>A5</td></tr> <tr><td>.625</td><td>.750</td><td>3/4</td><td>A6</td></tr> <tr><td>.750</td><td>.875</td><td></td><td>A7</td></tr> <tr><td>.875</td><td>1.000</td><td>1</td><td>A8</td></tr> <tr><td>1.000</td><td>1.125</td><td></td><td>B1</td></tr> <tr><td>1.125</td><td>1.250</td><td>1-1/4</td><td>B2</td></tr> <tr><td>1.250</td><td>1.375</td><td></td><td>B3</td></tr> <tr><td>1.375</td><td>1.500</td><td>1-1/2</td><td>B4</td></tr> <tr><td>1.500</td><td>1.625</td><td></td><td>B5</td></tr> <tr><td>1.625</td><td>1.750</td><td></td><td>B6</td></tr> <tr><td>1.750</td><td>1.875</td><td></td><td>B7</td></tr> </tbody> </table>	MIN.	MAX.	NPT SIZE for Threaded Adapters	ENTRY SIZE	.062	.125	1/8	A1	.125	.250	1/4	A2	.250	.375	3/8	A3	.375	.500	1/2	A4	.500	.625		A5	.625	.750	3/4	A6	.750	.875		A7	.875	1.000	1	A8	1.000	1.125		B1	1.125	1.250	1-1/4	B2	1.250	1.375		B3	1.375	1.500	1-1/2	B4	1.500	1.625		B5	1.625	1.750		B6	1.750	1.875		B7
MIN.	MAX.	NPT SIZE for Threaded Adapters	ENTRY SIZE																																																																			
.062	.125	1/8	A1																																																																			
.125	.250	1/4	A2																																																																			
.250	.375	3/8	A3																																																																			
.375	.500	1/2	A4																																																																			
.500	.625		A5																																																																			
.625	.750	3/4	A6																																																																			
.750	.875		A7																																																																			
.875	1.000	1	A8																																																																			
1.000	1.125		B1																																																																			
1.125	1.250	1-1/4	B2																																																																			
1.250	1.375		B3																																																																			
1.375	1.500	1-1/2	B4																																																																			
1.500	1.625		B5																																																																			
1.625	1.750		B6																																																																			
1.750	1.875		B7																																																																			

**NOTE:** Omit the Entry Size selection's last two digits from the part number when ordering a panel mount or dummy adapter.

### Insert Gender / Hardware Style Selection



### Insert Configuration Selection



### Entry Size Selection



# A-Line® Product Ordering Guide



Sample Part No.  
A421-3Y00-A6:

equals 21 pin, male connector kit equipped with 75° cable adapter and basketweave strain relief sized for cable O.D. of .625" to .750".

## Connector Kits

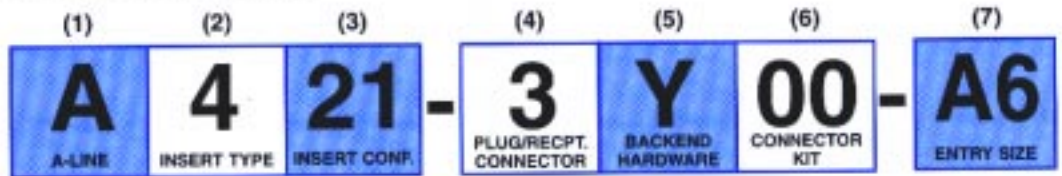

(1) A-Line	(2) Insert Type	(3) Insert Configuration	(4) Panel Mount Receptacle (1) Male (2) Female  Plug (3) Male (4) Female  In-line Flanged Receptacle (5) Male (6) Female  In-line Receptacle (7) Male (8) Female	(5) Connector Backend Hardware  (D) Straight Cable Adapter Plain  (K) Straight Cable Adapter w/ Basketweave  (T) Threaded Conduit Adapter  (X) 75° Cable Adapter  (Y) 75° Cable Adapter w/ Basketweave  (P) Panel Mount	(6) Calls Out Connector Kit Only	(7) MIN. MAX. ENTRY SIZE MPT SIZE For Threaded Adapters ENTRY SIZE INCHES
	5=20 AWG 4=16 AWG (GND) 3=16 AWG 2=12 AWG (GND) 1=12 AWG	Consult Pages 5-6				.062 .125 1/8 A1 .125 .250 1/4 A2 .250 .375 3/8 A3 .375 .500 1/2 A4 .500 .625 A5 .625 .750 3/4 A6 .750 .875 A7 .875 1.000 1 A8 1.000 1.125 B1 1.125 1.250 1-1/4 B2 1.250 1.375 B3 1.375 1.500 1-1/2 B4 1.500 1.625 B5 1.625 1.750 B6 1.750 1.875 B7

NOTE: Omit the Entry Size selection's last two digits from the part number when ordering a panel mount or dummy adapter.

### Insert Gender / Hardware Style Selection



### Insert Configuration Selection

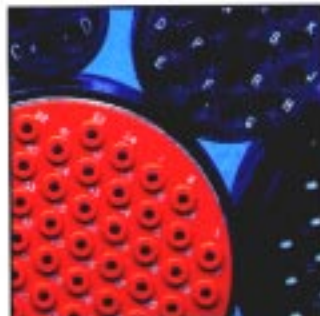

### Entry Size Selection



# Dimensional Information

## Plug Connectors

### (Overall Clearance Dimensions)

Note 1: Insert configuration determines connector shell size. Refer to pages 5-6.

Note 2: All dimensions shown are for overall clearance purposes. They are not necessarily true component dimensions. All metric dimension conversions are rounded.

### Straight w/wo Basketweave

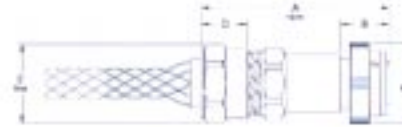

(Note 1) Shell Size	A	B	C	D	E	F	G	H	I
08	2.73 (69.34)	0.92 (23.37)	0.78 (19.81)	0.56 (14.22)	0.98 (24.89)	N/A	N/A	N/A	N/A
10	3.27 (83.06)	0.92 (23.37)	1.30 (33.02)	0.81 (20.57)	1.24 (31.50)	N/A	N/A	N/A	N/A
12	3.27 (83.06)	0.92 (23.37)	1.41 (35.81)	0.81 (20.57)	1.24 (31.50)	N/A	N/A	N/A	N/A
14	3.27 (83.06)	0.92 (23.37)	1.55 (39.37)	0.81 (20.57)	1.38 (35.05)	N/A	N/A	N/A	N/A
16	3.27 (83.06)	0.92 (23.37)	1.66 (42.16)	0.81 (20.57)	1.38 (35.05)	N/A	N/A	N/A	N/A
18	3.22 (81.79)	0.87 (22.10)	1.71 (43.43)	0.81 (20.57)	1.38 (35.05)	N/A	N/A	N/A	N/A
20	3.85 (97.79)	0.87 (22.10)	1.84 (46.73)	1.19 (30.23)	1.81 (45.97)	N/A	N/A	N/A	N/A
22	3.85 (97.79)	0.87 (22.10)	1.98 (50.29)	1.19 (30.23)	1.81 (45.97)	N/A	N/A	N/A	N/A
24	4.14 (105.15)	0.87 (22.10)	2.11 (53.59)	1.19 (30.23)	1.81 (45.97)	N/A	N/A	N/A	N/A
28	4.58 (116.32)	0.88 (22.35)	2.44 (61.98)	1.16 (29.46)	2.21 (56.13)	N/A	N/A	N/A	N/A
J28	4.70 (119.38)	1.00 (25.40)	2.44 (61.98)	1.16 (29.46)	2.21 (56.13)	N/A	N/A	N/A	N/A
36	5.38 (136.65)	1.18 (29.97)	2.97 (75.44)	1.16 (29.46)	2.79 (70.87)	N/A	N/A	N/A	N/A

### 75 Degree w/wo Basketweave



(Note 1) Shell Size	A	B	C	D	E	F	G	H	I
08	2.33 (59.16)	0.92 (23.37)	0.78 (19.81)	0.56 (14.22)	0.98 (24.89)	1.79 (45.47)	N/A	N/A	N/A
10	2.66 (67.56)	0.92 (23.37)	1.30 (33.02)	0.81 (20.57)	1.24 (31.50)	2.35 (59.69)	N/A	N/A	N/A
12	2.66 (67.56)	0.92 (23.37)	1.41 (35.81)	0.81 (20.57)	1.24 (31.50)	2.40 (60.96)	N/A	N/A	N/A
14	2.66 (67.56)	0.92 (23.37)	1.55 (39.37)	0.81 (20.57)	1.38 (35.05)	2.48 (62.99)	N/A	N/A	N/A
16	2.71 (68.83)	0.92 (23.37)	1.66 (42.16)	0.81 (20.57)	1.38 (35.05)	2.43 (61.72)	N/A	N/A	N/A
18	2.66 (67.56)	0.87 (22.10)	1.71 (43.43)	0.81 (20.57)	1.38 (35.05)	2.46 (62.48)	N/A	N/A	N/A
20	3.26 (82.80)	0.87 (22.10)	1.84 (46.73)	1.19 (30.23)	1.81 (45.97)	3.62 (91.95)	N/A	N/A	N/A
22	3.26 (82.80)	0.87 (22.10)	1.98 (50.29)	1.19 (30.23)	1.81 (45.97)	3.69 (93.73)	N/A	N/A	N/A
24	3.68 (93.47)	0.87 (22.10)	2.11 (53.59)	1.19 (30.23)	1.81 (45.97)	3.96 (100.58)	N/A	N/A	N/A
28	3.89 (98.72)	0.88 (22.35)	2.44 (61.98)	1.16 (29.46)	2.21 (56.13)	4.12 (104.65)	N/A	N/A	N/A
J28	3.81 (96.77)	1.00 (25.40)	2.44 (61.98)	1.16 (29.46)	2.21 (56.13)	4.12 (104.65)	N/A	N/A	N/A
36	4.20 (106.68)	1.18 (29.97)	2.97 (75.44)	1.16 (29.46)	2.79 (70.87)	4.69 (119.13)	N/A	N/A	N/A

### Dummy and Conduit Adapters

NOTE: Dummy adapter supplied with mounting chain.

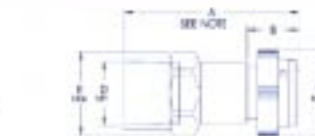

NOTE: Conduit adapter 'A' dim. does not include reducers or special fittings.

(Note 1) Shell Size	A	B	C	D	E	F	G	H	I
08	2.90 (71.12)	0.92 (23.37)	0.78 (19.81)	1.50 (38.10)	0.72 (18.29)	N/A	N/A	N/A	N/A
10	2.90 (71.12)	0.92 (23.37)	1.30 (33.02)	1.50 (38.10)	0.87 (22.10)	N/A	N/A	N/A	N/A
12	3.30 (83.82)	0.92 (23.37)	1.41 (35.81)	2.00 (50.80)	1.15 (29.21)	N/A	N/A	N/A	N/A
14	3.30 (83.82)	0.92 (23.37)	1.55 (39.37)	2.00 (50.80)	1.30 (33.02)	N/A	N/A	N/A	N/A
16	3.30 (83.82)	0.92 (23.37)	1.66 (42.16)	2.00 (50.80)	1.44 (36.58)	N/A	N/A	N/A	N/A
18	3.25 (82.65)	0.87 (22.10)	1.71 (43.43)	2.00 (50.80)	1.44 (36.58)	N/A	N/A	N/A	N/A
20	3.75 (95.25)	0.87 (22.10)	1.84 (46.73)	2.50 (63.50)	1.99 (49.39)	N/A	N/A	N/A	N/A
22	3.75 (95.25)	0.87 (22.10)	1.98 (50.29)	2.50 (63.50)	1.73 (43.94)	N/A	N/A	N/A	N/A
24	3.75 (95.25)	0.87 (22.10)	2.11 (53.59)	2.50 (63.50)	1.88 (47.75)	N/A	N/A	N/A	N/A
28	3.88 (98.55)	0.88 (22.35)	2.44 (61.98)	2.62 (66.55)	2.31 (58.67)	N/A	N/A	N/A	N/A
J28	4.00 (101.60)	1.00 (25.40)	2.44 (61.98)	2.62 (66.55)	2.31 (58.67)	N/A	N/A	N/A	N/A
36	4.81 (122.17)	1.18 (29.97)	2.97 (75.44)	3.25 (82.55)	2.75 (69.85)	N/A	N/A	N/A	N/A

# Dummy and Conduit Adapters cont.

(Note 1) Shell Size	Conduit Dimensions									
	A	B	C	D	E	F	G	H	I	
08	2.42 (61.47)	0.92 (23.37)	0.78 (19.81)	1/4 NPT	0.87 (22.10)	N/A	N/A	N/A	N/A	
10	2.42 (61.47)	0.92 (23.37)	1.30 (33.02)	1/2 NPT	1.15 (29.21)	N/A	N/A	N/A	N/A	
12	3.17 (80.52)	0.92 (23.37)	1.41 (35.81)	1/2 NPT	1.22 (30.99)	N/A	N/A	N/A	N/A	
14	2.92 (74.17)	0.92 (23.37)	1.55 (39.37)	3/4 NPT	1.44 (36.58)	N/A	N/A	N/A	N/A	
16	2.92 (74.17)	0.92 (23.37)	1.66 (42.16)	3/4 NPT	1.44 (36.58)	N/A	N/A	N/A	N/A	
18	2.87 (72.90)	0.87 (22.10)	1.71 (43.43)	3/4 NPT	1.44 (36.58)	N/A	N/A	N/A	N/A	
20	3.37 (85.60)	0.87 (22.10)	1.84 (46.73)	1 NPT	1.59 (40.39)	N/A	N/A	N/A	N/A	
22	3.37 (85.60)	0.87 (22.10)	1.98 (50.29)	1 NPT	1.73 (43.94)	N/A	N/A	N/A	N/A	
24	3.62 (91.95)	0.87 (22.10)	2.11 (53.59)	1 NPT	1.88 (47.75)	N/A	N/A	N/A	N/A	
28	4.13 (104.90)	0.88 (22.35)	2.44 (61.98)	1 1/4 NPT	2.31 (58.67)	N/A	N/A	N/A	N/A	
J28	4.25 (107.95)	1.00 (25.40)	2.44 (61.98)	1 1/4 NPT	2.31 (58.67)	N/A	N/A	N/A	N/A	
36	4.83 (122.22)	1.18 (29.97)	2.97 (75.44)	1 1/2 NPT	2.75 (69.85)	N/A	N/A	N/A	N/A	

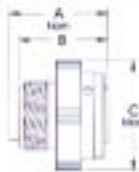

NOTE: Environmental cover supplied with mounting chain.



### Shell Dimensions

(Note 1) Shell Size	A	B	C
08	1.42 (36.07)	1.17 (29.72)	0.78 (19.81)
10	1.42 (36.07)	1.17 (29.72)	1.30 (33.02)
12	1.42 (36.07)	1.17 (29.72)	1.41 (35.81)
14	1.42 (36.07)	1.17 (29.72)	1.55 (39.37)
16	1.42 (36.07)	1.17 (29.72)	1.66 (42.16)
18	1.42 (36.07)	1.17 (29.72)	1.71 (43.43)
20	1.42 (36.07)	1.17 (29.72)	1.84 (46.73)
22	1.42 (36.07)	1.17 (29.72)	1.98 (50.29)
24	1.42 (36.07)	1.17 (29.72)	2.11 (53.59)
28	1.43 (36.32)	1.18 (29.97)	2.44 (61.98)
J28	1.55 (39.37)	1.30 (33.02)	2.44 (61.98)
36	1.73 (43.94)	1.48 (37.69)	2.97 (75.44)

### Cover Dimensions

(Note 1) Shell Size	A	B	C
08	0.94 (23.88)	0.56 (14.22)	0.72 (18.29)
10	0.94 (23.88)	0.56 (14.22)	0.84 (21.34)
12	0.94 (23.88)	0.56 (14.22)	1.00 (25.40)
14	0.94 (23.88)	0.56 (14.22)	1.13 (28.70)
16	0.94 (23.88)	0.56 (14.22)	1.25 (31.75)
18	0.94 (23.88)	0.56 (14.22)	1.38 (35.05)
20	1.01 (25.65)	0.63 (16.00)	1.50 (38.10)
22	1.01 (25.65)	0.63 (16.00)	1.63 (41.40)
24	1.04 (26.42)	0.66 (16.76)	1.75 (44.45)
28	1.23 (31.24)	0.85 (21.59)	2.06 (52.32)
J28	1.23 (31.24)	0.85 (21.59)	2.06 (52.32)
36	1.28 (32.51)	0.90 (22.86)	2.66 (67.56)



G = Mounting hole diameter.  
H = Minimum clearance dimension between panel mount centers. For mixed shell sizes, add clearance dimension for each, and divide by two.  
I = Panel cut-out dimension for front mount.

(Note 1) Shell Size	A	B	C	D	E	F	G	H	I
08	1.67 (42.42)	0.92 (23.37)	0.78 (19.81)	1.55 (39.37)	0.590 (14.99)	1.07 (27.18)	0.13 (3.30)	1.80 (45.72)	0.563 (14.30)
10	1.67 (42.42)	0.92 (23.37)	1.30 (33.02)	1.55 (39.37)	0.800 (20.32)	1.41 (35.81)	0.19 (4.83)	2.70 (68.58)	0.688 (17.48)
12	1.67 (42.42)	0.92 (23.37)	1.41 (35.81)	1.55 (39.37)	0.925 (23.50)	1.59 (40.39)	0.19 (4.83)	2.80 (71.12)	0.813 (20.68)
14	1.67 (42.42)	0.92 (23.37)	1.55 (39.37)	1.55 (39.37)	1.019 (25.88)	1.72 (43.69)	0.19 (4.83)	2.90 (73.66)	0.938 (23.83)
16	1.67 (42.42)	0.92 (23.37)	1.66 (42.16)	1.55 (39.37)	1.114 (28.30)	1.86 (47.24)	0.19 (4.83)	3.10 (78.74)	1.063 (27.00)
18	1.62 (41.15)	0.87 (22.10)	1.71 (43.43)	1.50 (38.10)	1.191 (30.25)	1.97 (50.04)	0.19 (4.83)	3.20 (81.28)	1.125 (28.58)
20	1.62 (41.15)	0.87 (22.10)	1.84 (46.73)	1.50 (38.10)	1.286 (32.64)	2.10 (53.34)	0.19 (4.83)	3.40 (86.36)	1.250 (31.75)
22	1.62 (41.15)	0.87 (22.10)	1.98 (50.29)	1.50 (38.10)	1.382 (34.99)	2.21 (56.13)	0.17 (4.32)	3.50 (88.90)	1.375 (34.93)
24	1.62 (41.15)	0.87 (22.10)	2.11 (53.59)	1.50 (38.10)	1.424 (36.17)	2.39 (60.70)	0.19 (4.83)	3.60 (91.44)	1.500 (38.10)
28	1.63 (41.40)	0.88 (22.35)	2.44 (61.98)	1.51 (38.35)	1.625 (41.28)	2.84 (72.14)	0.21 (5.33)	4.20 (106.68)	1.813 (46.06)
J28	1.75 (44.45)	1.00 (25.40)	2.44 (61.98)	1.63 (41.40)	1.750 (44.45)	2.84 (72.14)	0.21 (5.33)	4.20 (106.68)	1.813 (46.06)
36	1.93 (49.02)	1.18 (29.97)	2.97 (75.44)	1.81 (45.97)	2.094 (53.19)	3.43 (87.12)	0.26 (7.11)	4.60 (116.84)	2.312 (58.72)

# Plug Shell (Only) and Environmental Cover

# Panel Mount

# Dimensional Information Receptacle Connectors (Overall Clearance Dimensions)

- Note 1: Insert configuration determines connector shell size. Refer to pages 5-6.
- Note 2: All dimensions shown are for overall clearance purposes. They are not necessarily true component dimensions. All metric dimension conversions are rounded.

## In-line Straight w/wo Basketweave

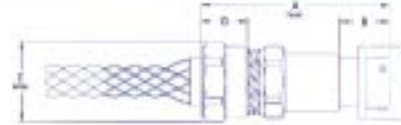

(Note 1) Shell Size	A	B	C	D	E	F	G
08	2.70 (68.58)	0.89 (22.61)	0.71 (18.00)	0.56 (14.22)	0.96 (24.89)	N/A	N/A
10	3.24 (82.30)	0.89 (22.61)	0.88 (22.35)	0.81 (20.57)	1.24 (31.50)	N/A	N/A
12	3.24 (82.30)	0.89 (22.61)	1.00 (25.40)	0.81 (20.57)	1.24 (31.50)	N/A	N/A
14	3.24 (82.30)	0.89 (22.61)	1.13 (28.70)	0.81 (20.57)	1.38 (35.05)	N/A	N/A
16	3.24 (82.20)	0.89 (22.61)	1.31 (33.27)	0.81 (20.57)	1.38 (35.05)	N/A	N/A
18	3.20 (81.28)	0.85 (21.59)	1.38 (35.05)	0.81 (20.57)	1.38 (35.05)	N/A	N/A
20	3.92 (99.57)	0.94 (23.88)	1.50 (38.10)	1.19 (30.27)	1.81 (45.97)	N/A	N/A
22	3.92 (99.57)	0.94 (23.88)	1.63 (41.40)	1.19 (30.27)	1.81 (45.97)	N/A	N/A
24	4.21 (106.90)	0.94 (23.88)	1.75 (44.45)	1.19 (30.27)	1.81 (45.97)	N/A	N/A
26	4.82 (122.43)	1.12 (28.45)	2.06 (52.32)	1.16 (29.46)	2.21 (56.13)	N/A	N/A
J26	4.82 (122.43)	1.12 (28.45)	2.06 (52.32)	1.16 (29.46)	2.21 (56.13)	N/A	N/A
36	5.62 (142.74)	1.42 (36.07)	2.66 (67.56)	1.16 (29.46)	2.79 (70.87)	N/A	N/A

## In-line 75 Degree w/wo Basketweave

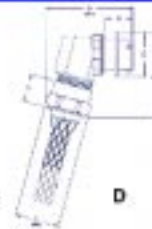

(Note 1) Shell Size	A	B	C	D	E	F	G
08	2.30 (58.42)	0.89 (22.61)	0.71 (18.03)	0.56 (14.22)	0.96 (24.89)	1.76 (44.70)	N/A
10	2.63 (66.80)	0.89 (22.61)	0.88 (22.35)	0.81 (20.57)	1.24 (31.50)	2.14 (54.36)	N/A
12	2.63 (66.80)	0.89 (22.61)	1.00 (25.40)	0.81 (20.57)	1.24 (31.50)	2.22 (56.38)	N/A
14	2.63 (66.80)	0.89 (22.61)	1.13 (28.70)	0.81 (20.57)	1.38 (35.05)	2.27 (57.66)	N/A
16	2.68 (68.07)	0.89 (22.61)	1.31 (33.27)	0.81 (20.57)	1.38 (35.05)	2.26 (57.40)	N/A
18	2.64 (67.06)	0.85 (21.59)	1.38 (35.05)	0.81 (20.57)	1.38 (35.05)	2.29 (58.17)	N/A
20	3.33 (84.58)	0.94 (23.88)	1.50 (38.10)	1.19 (30.27)	1.81 (45.97)	3.45 (87.63)	N/A
22	3.33 (84.58)	0.94 (23.88)	1.63 (41.40)	1.19 (30.27)	1.81 (45.97)	3.52 (89.41)	N/A
24	3.75 (95.25)	0.94 (23.88)	1.75 (44.45)	1.19 (30.27)	1.81 (45.97)	3.78 (96.01)	N/A
26	3.93 (99.82)	1.12 (28.45)	2.06 (52.32)	1.16 (29.46)	2.21 (56.13)	3.93 (99.82)	N/A
J26	3.93 (99.82)	1.12 (28.45)	2.06 (52.32)	1.16 (29.46)	2.21 (56.13)	3.93 (99.82)	N/A
36	4.75 (120.65)	1.42 (36.07)	2.66 (67.56)	1.16 (29.46)	2.79 (70.87)	4.50 (116.59)	N/A

## In-line Dummy and Conduit Adapters

NOTE: Dummy adapter supplied with mounting chain.

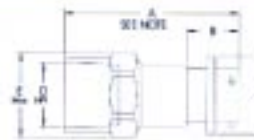

NOTE: Conduit adapter "A" dim. does not include reducers or special fittings.

Dummy Dimensions

(Note 1) Shell Size	A	B	C	D	E	F	G
08	2.77 (70.36)	0.89 (22.61)	0.71 (18.03)	1.50 (38.10)	0.72 (18.29)	N/A	N/A
10	2.77 (70.36)	0.89 (22.61)	0.88 (22.35)	1.50 (38.10)	0.87 (22.10)	N/A	N/A
12	3.27 (83.06)	0.89 (22.61)	1.00 (25.40)	2.00 (50.80)	1.15 (29.21)	N/A	N/A
14	3.27 (83.06)	0.89 (22.61)	1.13 (28.70)	2.00 (50.80)	1.30 (33.02)	N/A	N/A
16	3.27 (83.06)	0.89 (22.61)	1.31 (33.27)	2.00 (50.80)	1.44 (36.58)	N/A	N/A
18	3.23 (82.04)	0.85 (21.59)	1.38 (35.05)	2.00 (50.80)	1.44 (36.58)	N/A	N/A
20	3.82 (97.03)	0.94 (23.88)	1.50 (38.10)	2.50 (63.50)	1.59 (40.39)	N/A	N/A
22	3.82 (97.03)	0.94 (23.88)	1.63 (41.40)	2.50 (63.50)	1.73 (43.94)	N/A	N/A
24	3.82 (97.03)	0.94 (23.88)	1.75 (44.45)	2.50 (63.50)	1.88 (47.75)	N/A	N/A
26	4.12 (104.65)	1.12 (28.45)	2.06 (52.32)	2.62 (66.55)	2.31 (58.67)	N/A	N/A
J26	4.12 (104.65)	1.12 (28.45)	2.06 (52.32)	2.62 (66.55)	2.31 (58.67)	N/A	N/A
36	5.05 (128.27)	1.42 (36.07)	2.66 (67.56)	3.25 (82.55)	2.75 (69.85)	N/A	N/A

## In-line Dummy and Conduit Adapters cont.

(Note 1) Shell Size	Conduit Dimensions						
	A	B	C	D	E	F	G
08	2.39 (60.71)	0.89 (22.61)	0.71 (18.03)	1/4 NPT	0.87 (22.10)	N/A	N/A
10	2.39 (60.71)	0.89 (22.61)	0.88 (22.35)	1/2 NPT	1.15 (29.21)	N/A	N/A
12	3.14 (79.78)	0.89 (22.61)	1.00 (25.40)	1/2 NPT	1.22 (30.99)	N/A	N/A
14	2.89 (73.41)	0.89 (22.61)	1.13 (28.70)	3/4 NPT	1.44 (36.58)	N/A	N/A
16	2.89 (73.41)	0.89 (22.61)	1.31 (33.27)	3/4 NPT	1.44 (36.58)	N/A	N/A
18	2.85 (72.39)	0.85 (21.59)	1.38 (35.05)	3/4 NPT	1.44 (36.58)	N/A	N/A
20	3.44 (87.38)	0.94 (23.88)	1.50 (38.10)	1 NPT	1.59 (40.39)	N/A	N/A
22	3.44 (87.38)	0.94 (23.88)	1.63 (41.40)	1 NPT	1.73 (43.94)	N/A	N/A
24	3.89 (98.73)	0.94 (23.88)	1.75 (44.45)	1 NPT	1.88 (47.75)	N/A	N/A
28	4.37 (111.00)	1.12 (28.45)	2.06 (52.32)	1 1/4 NPT	2.31 (58.67)	N/A	N/A
J28	4.37 (111.00)	1.12 (28.45)	2.06 (52.32)	1 1/4 NPT	2.31 (58.67)	N/A	N/A
36	5.17 (131.32)	1.42 (36.07)	2.66 (67.56)	1 1/2 NPT	2.75 (69.85)	N/A	N/A



NOTE: Environmental cover supplied with mounting chain.



## In-line Receptacle Shell (Only) and Environmental Cover

(Note 1) Shell Size	Shell Dimensions		
	A	B	C
08	1.39 (35.31)	0.52 (13.21)	0.71 (18.03)
10	1.39 (35.31)	0.52 (13.21)	0.88 (22.35)
12	1.39 (35.31)	0.52 (13.21)	1.00 (25.40)
14	1.39 (35.31)	0.52 (13.21)	1.13 (28.70)
16	1.39 (35.31)	0.52 (13.21)	1.31 (33.27)
18	1.40 (35.56)	0.52 (13.21)	1.38 (35.05)
20	1.49 (37.85)	0.65 (16.51)	1.50 (38.10)
22	1.49 (37.85)	0.67 (17.02)	1.63 (41.40)
24	1.49 (37.85)	0.68 (17.27)	1.75 (44.45)
28	1.67 (42.42)	0.84 (21.34)	2.06 (52.32)
J28	1.67 (42.42)	0.84 (21.34)	2.06 (52.32)
36	1.97 (50.04)	0.99 (25.15)	2.66 (67.56)

(Note 1) Shell Size	Cover Dimensions		
	A	B	C
08	0.94 (23.88)	0.56 (14.22)	0.73 (18.54)
10	0.94 (23.88)	0.56 (14.22)	0.88 (21.84)
12	0.94 (23.88)	0.56 (14.22)	1.00 (25.40)
14	0.94 (23.88)	0.56 (14.22)	1.13 (28.70)
16	0.94 (23.88)	0.56 (14.22)	1.25 (31.75)
18	0.94 (23.88)	0.56 (14.22)	1.38 (35.05)
20	0.94 (23.88)	0.56 (14.22)	1.50 (38.10)
22	0.94 (23.88)	0.56 (14.22)	1.63 (41.40)
24	0.98 (24.89)	0.60 (15.24)	1.75 (44.45)
28	1.28 (32.51)	0.90 (22.86)	2.06 (52.32)
J28	1.28 (32.51)	0.90 (22.86)	2.06 (52.32)
36	1.38 (35.05)	1.00 (25.40)	2.66 (67.56)



D = Panel cut-out dimension for front mount.  
 F = Mounting hole diameter.  
 G = Minimum clearance dimension between panel mount centers.  
 For mixed shell sizes, add clearance dimension for each, and divide by two.

(Note 1) Shell Size	Panel Mount Dimensions						
	A	B	C	D	E	F	G
08	1.39 (35.31)	0.52 (13.21)	0.82 (20.83)	0.563 (14.30)	0.590 (14.99)	0.13 (3.30)	1.80 (45.72)
10	1.39 (35.31)	0.52 (13.21)	1.41 (35.81)	0.688 (17.48)	0.800 (20.32)	0.19 (4.83)	2.70 (68.58)
12	1.39 (35.31)	0.52 (13.21)	1.59 (40.39)	0.813 (20.65)	0.925 (23.50)	0.19 (4.83)	2.80 (71.12)
14	1.39 (35.31)	0.52 (13.21)	1.72 (43.89)	0.938 (23.83)	1.019 (25.86)	0.19 (4.83)	2.90 (73.66)
16	1.39 (35.31)	0.52 (13.21)	1.86 (47.24)	1.063 (27.00)	1.114 (28.30)	0.19 (4.83)	3.10 (78.74)
18	1.40 (35.56)	0.52 (13.21)	1.97 (50.04)	1.125 (28.58)	1.191 (30.25)	0.19 (4.83)	3.20 (81.28)
20	1.49 (37.85)	0.65 (16.51)	2.10 (53.34)	1.250 (31.75)	1.285 (32.64)	0.19 (4.83)	3.40 (86.36)
22	1.49 (37.85)	0.67 (17.02)	2.21 (56.13)	1.375 (34.93)	1.362 (34.59)	0.19 (4.83)	3.50 (88.90)
24	1.49 (37.85)	0.68 (17.27)	2.39 (60.71)	1.500 (38.10)	1.424 (36.17)	0.19 (4.83)	3.60 (91.44)
28	1.67 (42.42)	0.84 (21.34)	2.69 (68.33)	1.813 (46.05)	1.625 (41.28)	0.21 (5.33)	4.20 (106.68)
J28	1.67 (42.42)	0.84 (21.34)	2.84 (72.14)	1.813 (46.05)	1.750 (44.45)	0.21 (5.33)	4.20 (106.68)
36	1.97 (50.04)	0.99 (25.15)	3.43 (87.12)	2.312 (58.72)	2.094 (53.19)	0.29 (7.11)	4.60 (116.84)

## Panel Mount

# Dimensional Information Mounting Adapters

## "L" Bracket

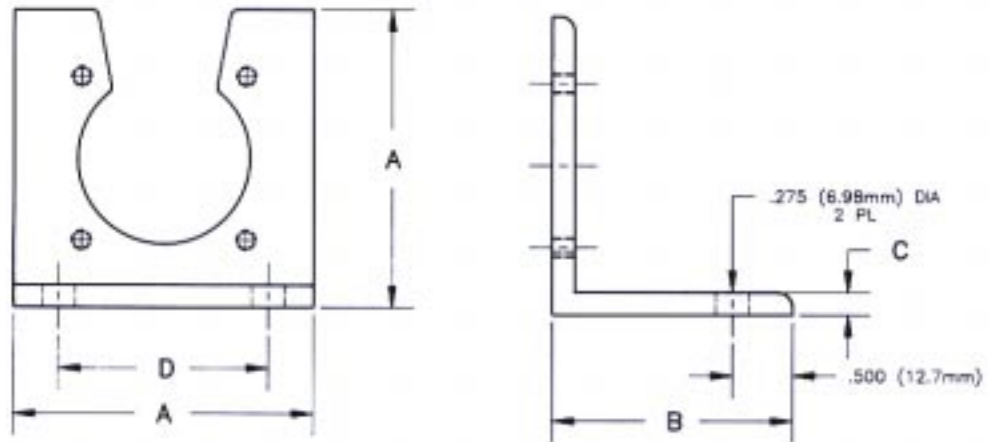

Shell Size*	Dimensions Inches (mm)**			
	A	B	C	D
08-24	2.50 (63.50)	2.00 (50.80)	0.19 (4.83)	1.75 (44.45)
28-36	3.50 (88.90)	2.50 (63.50)	0.25 (6.35)	1.75 (44.45)

## Angle Adapter

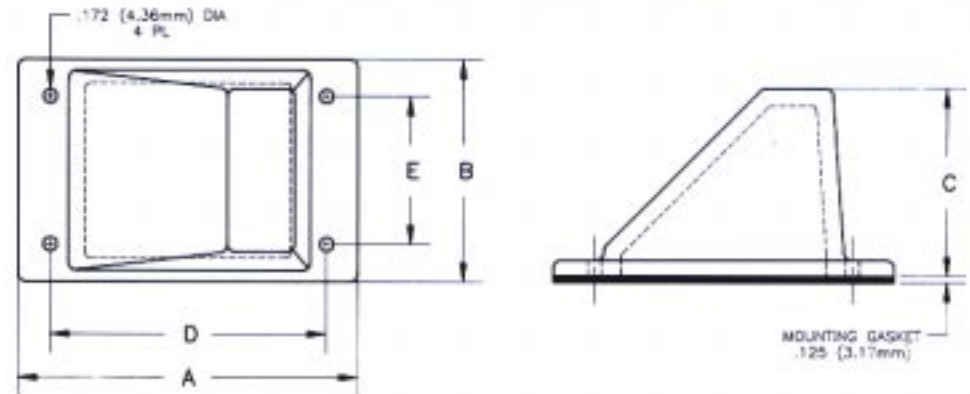

Shell Size*	Dimensions Inches (mm)**					
	A	B	C	D	E	Panel Cut-Out
08-22	4.30 (109.22)	2.82 (71.63)	2.38 (60.45)	3.25 (82.55)	1.88 (47.75)	2.00 x 2.50 (50.80 x 63.50)
24 (45°)	4.30 (109.22)	2.82 (71.63)	2.38 (60.45)	3.25 (82.55)	1.88 (47.75)	2.00 x 2.50 (50.80 x 63.50)
24 (86°)	6.44 (163.58)	4.56 (115.82)	3.63 (92.20)	5.44 (138.18)	3.25 (82.55)	3.75 x 4.25 (95.25 x 107.95)
28	6.44 (163.58)	4.56 (115.82)	3.63 (92.20)	5.44 (138.18)	3.25 (82.55)	3.75 x 4.25 (95.25 x 107.95)
J28	6.44 (163.58)	4.56 (115.82)	3.63 (92.20)	5.44 (138.18)	3.25 (82.55)	3.75 x 4.25 (95.25 x 107.95)
36	6.44 (163.58)	4.56 (115.82)	3.63 (92.20)	5.44 (138.18)	3.25 (82.55)	3.75 x 4.25 (95.25 x 107.95)

\* Shell size is determined by insert configuration. Refer to pages 5 & 6.

\*\* All metric dimension conversions are rounded.

## Accessories

### Mounting Adapters



Shell Size*	45 Degree Angle Adapter	86 Degree Angle Adapter	"L" Bracket
08	CA-2510-08	CA-2515-08	CA-2517-08-T
10	CA-2510-10	CA-2515-10	CA-2517-10-T
12	CA-2510-12	CA-2515-12	CA-2517-12-T
14	CA-2510-14	CA-2515-14	CA-2517-14-T
16	CA-2510-16	CA-2515-16	CA-2517-16-T
18	CA-2510-18	CA-2515-18	CA-2517-18-T
20	CA-2510-20	CA-2515-20	CA-2517-20-T
22	CA-2510-22	CA-2515-22	CA-2517-22-T
24	CA-2510-24	CA-2515-24	CA-2517-24-T
28	CA-2510-28	CA-2515-28	CA-2517-28-T
J28	CAJ-2510-28	CAJ-2515-28	CAJ-2517-28-T
36	CA-2510-36	CA-2515-36	CA-2517-36-T

### Environmental Covers



Shell Size*	Plug Cover With Ring	Plug Cover With Eyelet	Receptacle Cover With Ring	Receptacle Cover With Eyelet
08	CA-5508-A	CA-5508-A-F	CA-5608-A	CA-5608-A-F
10	CA-5510-A	CA-5510-A-F	CA-5610-A	CA-5610-A-F
12	CA-5512-A	CA-5512-A-F	CA-5612-A	CA-5612-A-F
14	CA-5514-A	CA-5514-A-F	CA-5614-A	CA-5614-A-F
16	CA-5516-A	CA-5516-A-F	CA-5616-A	CA-5616-A-F
18	CA-5518-A	CA-5518-A-F	CA-5618-A	CA-5618-A-F
20	CA-5520-A	CA-5520-A-F	CA-5620-A	CA-5620-A-F
22	CA-5522-A	CA-5522-A-F	CA-5622-A	CA-5622-A-F
24	CA-5524-A	CA-5524-A-F	CA-5624-A	CA-5624-A-F
28	CA-5528-A	CA-5528-A-F	CA-5628-A	CA-5628-A-F
J28	CAJ-5528-A	CAJ-5528-A-F	CAJ-5628-A	CAJ-5628-A-F
36	CA-5536-A	CA-5536-A-F	CA-5636-A	CA-5636-A-F

\* Shell size is determined by insert configuration. Refer to pages 5 & 6.

# Tools and Replacement Contacts

## Insertion / Extraction Tools (Metal)

Contact Size	Tool Number
12	CA-5K12
16	CA-5K16
20	CA-5K20



## Insertion / Extraction Tools (Plastic)

Contact Size	Tool Number
12	CA-5H12
16	CA-5H16
20	CA-5H20



## Contact Tool Inspection Gauge

Contact Size	Tool Number
12	CO-5G12
16	CO-5G16
20	CO-5G20



## Hand Crimp Tool

Contact Size	Tool Number
12, 16, 20	CA-5D12



Contact Size	Tool Number
12, 16, 20	CA-5E12



## Pneumatic Crimp Tool

Contact Size	Tool Number
12, 16	CA-5J16



## Ground Clip Crimping Tool

Contact Size	Pin Number	Socket Number	Ground* Pin Number	Ground* Clip Number (New Style)	Ground* Clip Number (Old Style)	Blank Seal Number
12	CA-4012-1K	CA-4112-1K	CA-4012-2N	CA-4212-2T	—	CA-4012-59
16	CA-4016-1K	CA-4116-1K	CA-4016-2N	CA-4216-2T	CA-4216-2N	CA-4016-59
20	CA-4020-1K	CA-4120-1K	—	—	—	CA-4020-59

## Replacement Contacts

Pin (Male) Contact

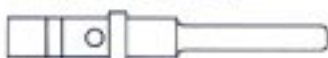

Socket (Female) Contact



Ground Clip (New Style)



Ground Clip (Old Style)



Blank Seal



\* Ground pin is silver plated and ground clip is tin plated.

# Engineering Data

## Performance Specifications

### Contact Data

The A-Line connector line is built to conform to and exceed the test requirements of MIL-C-26482 Series II specification. It is also compatible with and mateable to similar MIL-C-26482 Series II connector layouts.

Contact Size	Test Current (Amps)	Max. Current Rating (Amps)	M.V. Drop (Millivolts)	Max. Wire AWG Dia. Inches (mm)*	Max. Ins. Wire Dia. Inches (mm)*	Crimp Wire Barrel Depth Inches (mm)*	Wire AWG Crimp Range
Notes -	1	2	3	4	5	6	7
20	7.5	17	50	.048(1.21)	.083 (2.10)	.160 (4.06)	20, 22, 24
16	13	25	45	.066 (1.67)	.103 (2.61)	.246 (6.24)	16, 18, 20
12	23	41	38	.098 (2.48)	.158 (4.01)	.246 (6.24)	12, 14, 16

1. Contact (only) - Non-interrupting test current as prescribed by MIL-C-39029 for developing voltage drop across, end to end, of mated pin and socket contacts.
2. Maximum Current - Non-interrupting, rating for single contact, maximum total current per connector is dependent upon contact density, ambient temperature, wire insulation temperature rating, sea level or altitude application. Refer to MIL-W-5088 for guidance.
3. Millivolt drop measurement made at opposite terminal, ends of wired mated contact pairs with noted test current.
4. Based on crimp contact wire barrel dimensions.
5. Maximum insulated wire overall diameter - based upon insert rear wire entry.
6. Contact wire barrel depth defines insulated wire strip length.
7. Range of wire AWG that can be crimped to given contact size.

\* All metric dimension conversions are rounded.

### Performance Data

<b>Operating Temperature Rating</b>	-85°F (-65°C) to 392°F (200°C). The combination of ambient temperatures and current loading of contacts must not produce an insert temperature in excess of 392°F (200°C).
<b>Corrosion Resistance</b>	Exceeds MIL-C-26482 Series II 48 hour standard with no exposure of base metal as defined in method 1001 of MIL-STD-1344.
<b>Durability</b>	Exceeds MIL-C-26482 Series II standard of connector halves mated and unmated 500 times under normal operative service.
<b>Fluid Resistance</b>	Resistant to most oils, acids and alkalis (other fluids can be tested on request).
<b>Humidity &amp; Moisture Resistance</b>	Exceeds MIL-C-26482 Series II specification requirements as defined in method 1002 of MIL-STD-1344.
<b>Air Leakage</b>	Exceeds MIL-C-26482 Series II specification requirement of .1 micron per cubic foot per hour maximum, where subjected to differential pressure of 14.7 lbs. per square inch.
<b>Shock</b>	Meets MIL-STD-1344, method 2004.
<b>Vibration</b>	Meets MIL-STD-1344, method 2005.
<b>Approvals</b>	U.L. recognized, CSA approved. Consult factory for specific insert configurations.

• Recognized under the Component Program of Underwriters Laboratories, Inc. for 250 volts.  
File No. E109316 

• Certified by Canadian Standards Association.  
File No. LR83458



# Cable Information

16 AWG control and signal cable, flexible PVC construction, 600 volt, 80°C.

SINE PART NUMBER	UL TYPE	NO. OF COND.	NOMINAL D.C.R. OHMS / M FT COND.	NOMINAL CAPACITANCE AT 1KHz *pF / FT	NOMINAL JACKET THICKNESS	NOMINAL O.D.	MINIMUM BEND RADIUS (inches)	SHIPPING WEIGHT LBS/1000'
KA-8016-05	1063	05	4.46	28	.050	.400±.015	4.0	98
KA-8016-12	1063	12	4.46	28	.065	.580±.015	6.0	207
KA-8016-16	1063	16	4.46	28	.067	.630±.015	6.5	259
KA-8016-21	1063	21	4.46	28	.073	.723±.020	7.5	339
KA-8016-31	1063	31	4.46	28	.088	.870±.020	9.0	562
KA-8016-41	1063	41	4.46	28	.085	.950±.020	9.5	618
KA-8016-60	1063	60	4.46	28	.096	1.120±.025	11.6	910

16 AWG control and signal cable, flexible PVC construction, overall tinned copper braid and aluminum foil shielding, 600 volt, 80°C.

SINE PART NUMBER	UL TYPE	NO. OF COND.	NOMINAL D.C.R. OHMS / M FT COND. SHIELD	NOMINAL CAPACITANCE AT 1KHz *pF / FT **pF / FT	NOMINAL JACKET THICKNESS	NOMINAL O.D.	MINIMUM BEND RADIUS (inches)	APPROX. WEIGHT LBS/1000'
KA-8116-05	1063	05	4.46	33 59	.050	.400±.015	4.0	248
KA-8116-12	1063	12	4.46	33 59	.065	.587±.015	6.0	281
KA-8116-16	1063	16	4.46	33 59	.067	.654±.015	6.5	281
KA-8116-21	1063	21	4.46	33 59	.073	.730±.020	7.5	375
KA-8116-31	1063	31	4.46	33 59	.088	.950±.020	9.0	572
KA-8116-41	1063	41	4.46	33 59	.085	.990±.020	10.0	712.5
KA-8116-60	1063	60	4.46	33 59	.096	1.160±.025	11.6	1087

16 AWG control and signal cable, heavy-duty flexing, polyethylene conductor insulation and Hypalon jacket, 600 volt, 105°C.

SINE PART NUMBER	NO. OF COND.	COND. SIZE AWG	STRANDING	INSULATION / XLPE NYLON THICKNESS	JACKET MIN. AVG. THICK (inches)	NOMINAL O.D.	MINIMUM BEND RADIUS (inches)	SHIPPING WEIGHT LBS/1000'
KA-8N16-12	12	16	26 / 30	.015 / .005	.060	.590±.025	6.0	78
KA-8N16-16	16	16	26 / 30	.015 / .005	.060	.650±.025	6.5	189
KA-8N16-21	21	16	26 / 30	.015 / .005	.060	.730±.030	7.5	225
KA-8N16-31	31	16	26 / 30	.015 / .005	.060	.835±.030	9.0	387
KA-8N16-41	41	16	26 / 30	.015 / .005	.080	.975±.035	10.0	648
KA-8N16-60	60	16	26 / 30	.015 / .005	.080	1.110±.040	11.5	945
KA-8N12-07	07	12	65 / 30	.016 / .005	.063	.600±.020	6.5	480
KA-8N44-212	04	4	420 / 30	.045 / .008	.085	1.115±.040	12.0	1370
	02	12	65 / 30	.016 / .005				

20 AWG instrument cable, shielded overall, flexible PVC construction, overall tinned copper braid and aluminum foil shielding, 300 volt, 105°C.

SINE PART NUMBER	UL TYPE	NO. OF COND.	NOMINAL D.C.R. OHMS / M FT COND. SHIELD	NOMINAL CAPACITANCE AT 1KHz *pF / FT **pF / FT	NOMINAL JACKET THICKNESS	NOMINAL O.D.	MINIMUM BEND RADIUS (inches)	SHIPPING WEIGHT LBS/1000'
KA-7120-06	2517	06	9.4 3.2	34 .62	.064	.326±.008	3.3	81
KA-7120-10	2517	10	9.4 3.7	34 .62	.064	.400±.010	4.0	119
KA-7120-22	2517	22	9.4 1.9	34 .62	.064	.490±.010	4.9	194
KA-7120-32	2517	32	9.4 2.0	34 .62	.064	.550±.015	5.5	254
KA-7120-48	2517	48	9.4 2.0	34 .62	.064	.645±.015	6.5	359
KA-7120-61	2517	61	9.4 1.9	34 .62	.064	.690±.015	6.9	508

20 AWG multi-paired, individually shielded, instrument cable, flexible PVC construction, each pair individually shielded with tinned copper braid and aluminum foil shielding, 300 volt, 80°C.

SINE PART NUMBER	UL TYPE	NO. OF COND.	NO. OF PAIRS	NOMINAL D.C.R. OHMS / M FT COND. SHIELD	NOMINAL CAPACITANCE AT 1KHz *pF / FT **pF / FT	NOMINAL JACKET THICKNESS	NOMINAL O.D.	MINIMUM BEND RADIUS	SHIPPING WEIGHT LBS/1000'
KA-7220-02PR	2343	05	02	9.76 4.1	55 101	.064	.435±.010	4.5	110
KA-7220-04PR	2343	09	04	9.76 4.1	55 101	.064	.490±.010	5.0	163
KA-7220-09PR	2343	19	09	9.76 4.1	55 101	.064	.680±.010	7.0	339
KA-7220-15PR	2343	31	15	9.76 4.1	55 101	.064	.830±.020	8.5	551
KA-7220-20PR	2343	41	20	9.76 4.1	55 101	.064	.940±.020	9.5	670
KA-7220-30PR	2343	60	30	9.76 4.1	55 101	.064	1.090±.020	10.1	1009

16 AWG multi-conductor control and signal cable, heavy-duty flexing, expanded PTFE® conductor insulation, 600 volt, 105°C.

SINE PART NUMBER	UL TYPE	NO. OF COND.	NOMINAL D.C.R. OHMS / M FT COND.	NOMINAL CAPACITANCE AT 1KHz *pF / FT	NOMINAL JACKET THICKNESS	NOMINAL O.D.	MINIMUM BEND RADIUS (inches)	WEIGHT LBS/1000'
KA-7N16-05	20821	5	4.59	19.8		.460±.020	4.8	141
KA-7N16-12	20821	12	4.59	19.8	.045	.470±.020	4.7	201
KA-7N16-16	20821	16	4.59	19.8	.045	.580±.020	5.8	268
KA-7N16-21	20821	21	4.59	19.8	.060	.625±.020	6.25	351
KA-7N16-31	20821	31	4.59	19.8	.060	.720±.020	7.20	454
KA-7N16-41	20821	41	4.59	19.8	.060	.810±.020	8.10	643
KA-7N16-60	20821	60	4.59	19.8				

## Type "80"

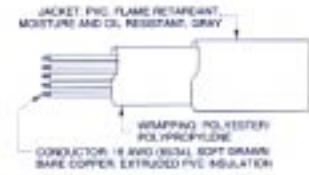

## Type "81"

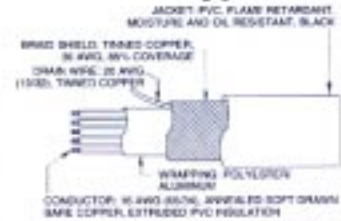

## Type "8N"

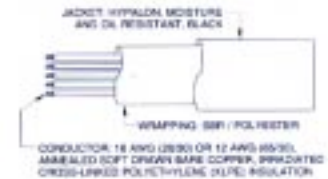

## Type "71"

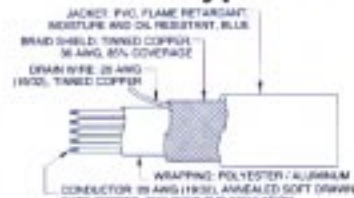

## Type "72"

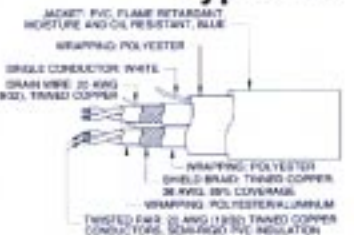

## Type "7N"

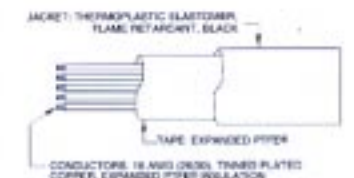

COLOR CODE REFERENCE: Consult Factory

\* Capacitance between conductors \*\* Capacitance between one conductor and all other conductors connected to shield

## Product Information

### V-Line® Electrical Connectors

V-Line represents a commitment to quality and performance in the manufacturing of heavy-duty, industrial, multi-pin, electrical connectors. Designed for commercial and industrial applications, V-Line is a low profile, quick mate, threaded coupling system, environmental, control and signal connector. V-Line is available with a comprehensive selection of insert and hardware configurations accompanied by optional accessories.



### R-Line® Electrical Connectors

R-Line is an economical alternative for applications where DIN 43852 "Rectangular" connectors are specified. The R-Line connector series is manufactured in Europe to the most demanding quality standards and is stocked extensively here in North America for quick lead times and faster assembly services. These connectors are available in a variety of layouts with either crimp or screw termination contacts. Available as connector kits or completed cable and receptacle assemblies.



### X-Line® Electrical Connectors

X-Line connectors represent a commitment to quality and performance in the manufacturing of extra heavy-duty, multi-pin, electrical connectors. Designed for rugged and harsh environments X-Line meets those demanding control and power applications. X-Line offers a comprehensive array of insert and hardware configurations accompanied by accessory components.



### P-Lok® Electrical Connectors

P-Lok connectors are engineered to meet the requirements of many heavy-duty industrial applications. Features inherent in P-Lok's design allow for quick, easy, single-handed connect and disconnect functions of your cable assemblies. P-Lok connectors are available with a comprehensive selection of insert and hardware configurations or as part of complete cable assemblies featuring injection molded rear end strain reliefs.



### ProPORT™ Data Access Panels

ProPort Data Access Panels are the latest in data connection hardware designed to eliminate the opening of industrial control panels while connecting a P.C. to a "PLC" and industrial data network systems. Each convenient port is engineered to provide almost instant access to power and data connections while withstanding the harsh factory floor environment. ProPort Data Access Panels are available in a variety of standard off the shelf models as well as custom manufactured versions.



# Solutions By Design<sup>SM</sup>

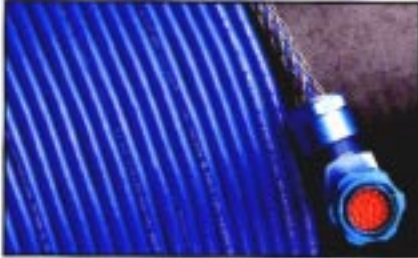

The Sine Companies, Inc. is a qualified assembly house capable of servicing electrical and electronic interconnect system needs featuring a variety of multi-conductor cable products. Sine specializes in those challenging applications demanding extended flex-life, tight bend radii, high temperatures, chemical and abrasion resistance, aesthetics, and much more.

## Custom Cable Assembly



The Sine Companies, Inc. has the engineering resources and experience to design and manufacture a vast array of interconnect products to meet your very specific application demands. Through evaluation of these demands, Sine can assist you in effectively designing a product tolerant of environmental stresses such as extreme temperatures, high insertion forces, vibration and most corrosive environments.

## Custom Connector Manufacturing



As a complete service interconnect systems specialist, Sine has the engineering resources to address the most demanding applications. Engineered solutions featuring custom molded and machined connectors, wire harness assemblies, electronic or electro-mechanical devices and prototyping are readily available. Sine engineers are available to assist our customers during all facets of product management.

## Engineering



Sine manufactures custom injection molded connectors and cable assemblies. Many applications require specialized connectors or cable assemblies that demand engineered solutions, best addressed by the molding process. Sine has the in-house ability to design and build the necessary molds, dies and patterns required for molded parts manufacturing. Sine uses the latest computerized molding equipment to maximize efficiency with no compromise in quality.

## Injection Molding



Sine is a distributor and value-added supplier for companies such as AMP, Burndy, C&M, Belden, Foxconn, NKK, Souriau and W.L. Gore. Customer interconnect needs can readily be satisfied with brand name products that are available from Sine's well maintained inventory. Sine's facility has been registered by Underwriters Laboratories, Inc. to the International Organization for Standardization ISO 9000 Series Standards for quality.

## Value-Added Distribution



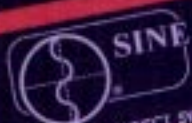

**SINE**

TOTAL INTERCONNECT SYSTEMS  
SPECIALISTS

### The Sine Companies, Inc.

P.O. Box 2336  
23325 Joy Boulevard  
Mt. Clemens, MI 48046-2336  
Phone: 810-465-3131  
Fax: 810-465-1216



SOLUTIONS BY DESIGN™

**ISO 9000**  
REGISTERED FIRM

## X-ON Electronics

Largest Supplier of Electrical and Electronic Components

*Click to view similar products for [Circular MIL Spec Connector](#) category:*

*Click to view products by [Amphenol](#) manufacturer:*

Other Similar products are found below :

[0025-262-542](#) [0025-264-3014](#) [58-570121-04S](#) [0134-202-1200](#) [0134-207-1206](#) [0134-207-1800](#) [0134-207-2207](#) [0134-213-0806](#) [0134-213-1007](#) [0134-213-1009](#) [0134-213-1208](#) [0134-213-1800](#) [0134-213-2209](#) [0025-258-000](#) [015-9516-002](#) [60-042722-19P](#) [0114-201-1278](#) [602GB06EG24-61SN](#) [0134-201-1207](#) [0134-201-1806](#) [0134-201-2006](#) [0134-201-2007](#) [0134-201-2010](#) [0134-202-1400](#) [0134-207-0809](#) [0134-207-1208](#) [0134-207-2009](#) [0134-213-1006](#) [6104-207-2302](#) [6104-208-1902](#) [6131-202-19149P](#) [6131-204-21149P](#) [6131-207-13149P](#) [6131-208-13149P](#) [6131-209-17149P](#) [6131-210-11149P](#) [6131-211-19149P](#) [6131-216-19149P](#) [6131-220-25149P](#) [6131-259-11149P](#) [6131-259-21149P](#) [6131-259-23149P](#) [6131-263-19149P](#) [6131-265-17149P](#) [6131-265-19149P](#) [CS3102A-20-15P](#) [CS3102A-20-15S](#) [CS3102C18-4P-472](#) [CS3106A-20-29P](#) [CS3106A-20-74P](#)