



Welcome to the World of AirBorn Interconnect Solutions

JULY 2009

AirBorn has been manufacturing high reliability interconnect systems for more than 45 years with leading-edge, innovative technology that is more reliable and better-performing than practically all other alternatives.

Our advanced technologies, experienced design support, incomparable lead times and personalized customer service and support provide customers with complete solutions to a vast array of highly specialized design requirements in diverse markets and applications.

You will find in this catalog technical drawings and specification information that will help you solve your interconnection needs from the design stage through production specification.

The products in this catalog are organized by the AirBorn part number assigned to them.

Each connector part number identifies five elements:

- AirBorn Series
- Body
- Size (number of contacts)
- Contact Type
- Hardware Type

Each catalog page shows the choices available for each of these elements. By selecting one option from any category on the page, you can build a set of connectors to meet your requirements.

If you do not find a particular connector size or option, please contact AirBorn for further assistance. AirBorn can manufacture special configurations for your exact specifications.

When everything matters, go AirBorn.

www.AirBorn.com

AirBorn International LTD

Mercury House, Station Road
Edenbridge. Kent. TN8 6HL
United Kingdom

Phone: +44 (0)1732 864930
E-mail: cs@airbornint.com

AirBorn

4321 AirBorn Drive
Addison, TX 75001-0519
United States

Phone: (972) 931-3200
Fax: (972) 931-9305
E-mail: info@airborn.com

AirBorn

3500 AirBorn Circle
Georgetown, TX 78626
United States

Phone: (512) 863-5585
Fax: (512) 863-8259
E-mail: info@airborn.com

"M" SERIES - .050"
MIL-DTL-83513
See pages M-5 thru M-126

"MHT" SERIES - .050"
High Temperature
See pages MHT-1 thru MHT-24

"M" SERIES ACCESSORIES
See pages MA-1 thru MA-25

MILITARY CROSS REFERENCE
See pages MIL-1 thru MIL-22

**Micro-Strip
Connectors
Cable to Cable**

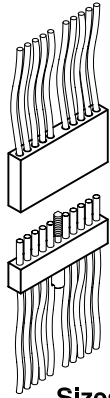

1 Row
Sizes: 3 thru 60
Page: M-11

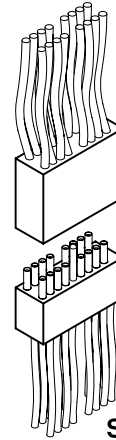

2 Row
Sizes: 4 thru 128
Page: M-23

**Micro-Strip
Connectors
Board to Cable**

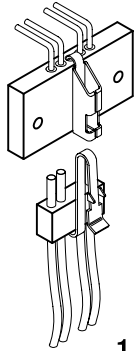

1 Row
Sizes: 3 thru 60
Page: M-13

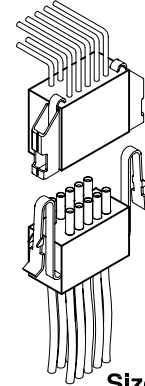

2 Row
Sizes: 4 thru 128
Page: M-25

**Micro-D
Connectors
Cable to Cable**

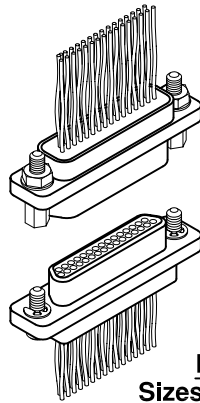

Rugged
Sizes: 9 thru 100
Page: M-35
High Temperature Sizes: 9 thru 100
Page: MHT-7

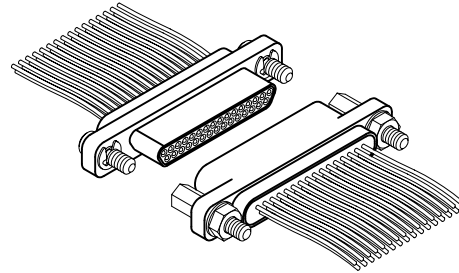

Low Profile
Sizes: 9 thru 51
Page: M-39
High Temperature Sizes: 9 thru 51
Page: MHT-9

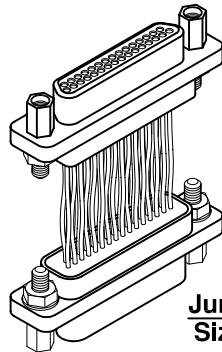

**Rugged,
Jumper Assembly**
Sizes: 9 thru 100
Page: M-37

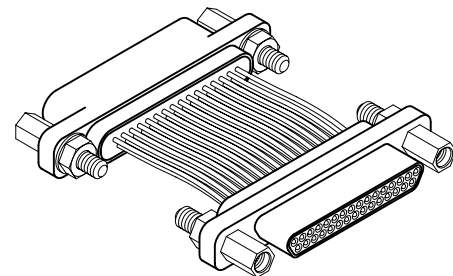

Low Profile, Jumper Assembly
Sizes: 9 thru 51
Page: M-41

Micro-D Connectors Board to Cable

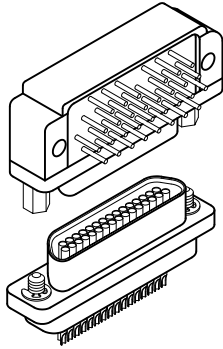

**Rugged Right Angle,
Narrow Footprint**

Sizes: 9 thru 100

Pages: M-43 & M-48

High Temperature Sizes: 9 thru 100

Pages: MHT-11 & MHT-13

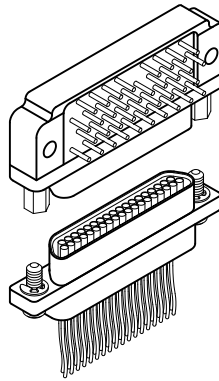

**Low Profile Right Angle,
Narrow Footprint**

Sizes: 9 thru 51

Pages: M-51 & M-54

High Temperature Sizes: 9 thru 51

Pages: MHT-17 & MHT-19

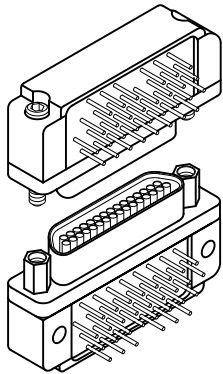

Rugged, Flex Cable

Sizes: 9 thru 100

Page: M-49

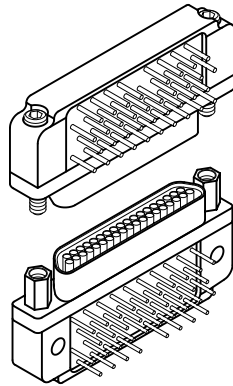

Low Profile, Flex Cable

Sizes: 9 thru 51

Page: M-55

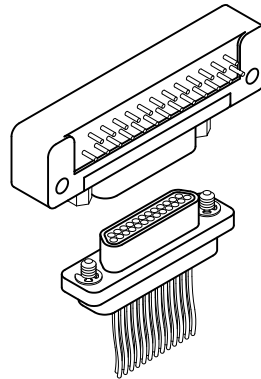

**Rugged Right Angle,
Standard Footprint**

Sizes: 9 thru 100

Pages: M-61 & M-63

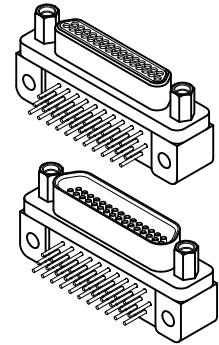

**Rear Panel Mount
Compressed Footprint**

Sizes: 9 thru 100

Pages: M-60.1 & M-60.4

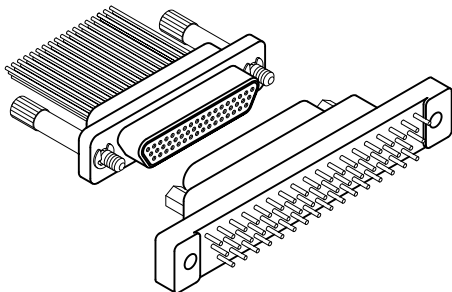

**Rugged Straight,
Narrow Footprint**

Sizes: 9 thru 100

Pages: M-67 & M-69

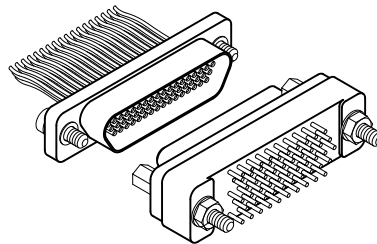

**Rugged Straight,
Standard Footprint**

Sizes: 9 thru 100

Pages: M-73 & M-75

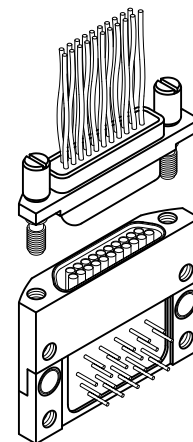

**Low Profile, Radius Shell
High Temperature Sizes: 9 thru 51**

Page: MHT-23

**Micro-D
Connectors
Surface Mount
Board to Cable**

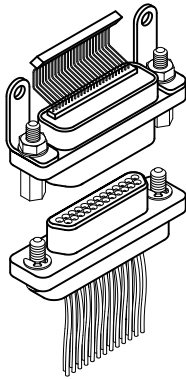

**Rugged Horizontal,
Surface Mount**
Sizes: 9 thru 51
Pages: M-83 & M-85

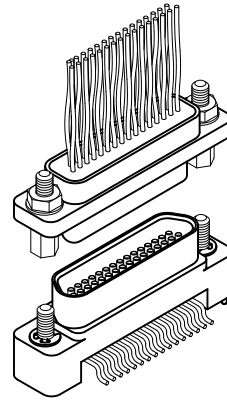

**Rugged Vertical,
Surface Mount**
Sizes: 9 thru 51
Pages: M-89 & M-91

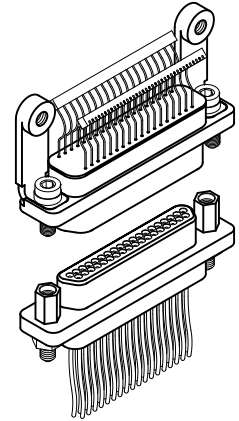

**Rugged
Card Edge Mount**
Sizes: 9 thru 100
Pages: M-95 & M-97

**Micro-D
Connectors
Filtered Cable**

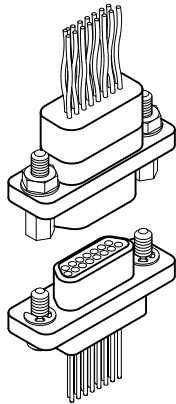

Rugged Filtered
Sizes: 9 thru 37
Page: M-103

**Micro-D
Connectors
Hybrid Cable**

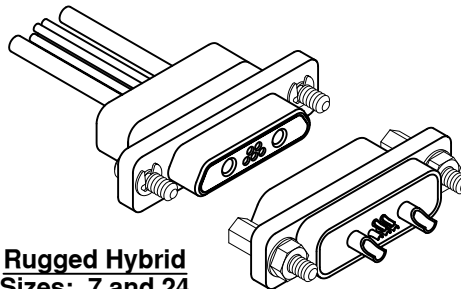

Rugged Hybrid
Sizes: 7 and 24
Page: M-107

**Circular Cable
Connectors**

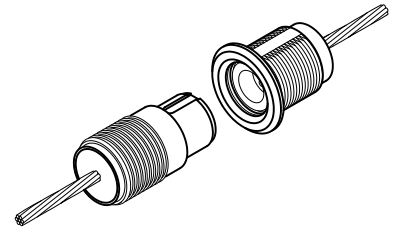

Circular
Sizes: 7 & 19
Page: M-109

**Micro-D
Connectors
Rear Panel
Mount**

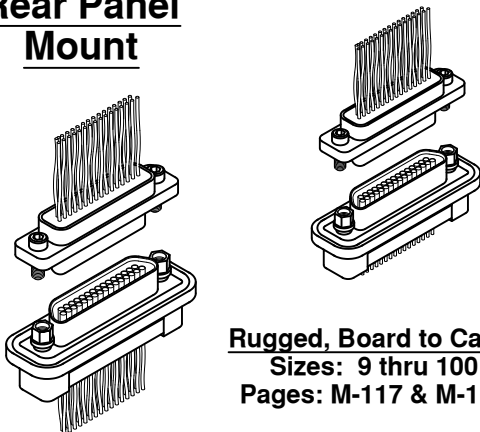

Rugged, Board to Cable
Sizes: 9 thru 100
Pages: M-117 & M-119

Rugged, Cable to Cable
Sizes: 9 thru 100
Pages: M-113 & M-115

**Right Angle
Boardmount**

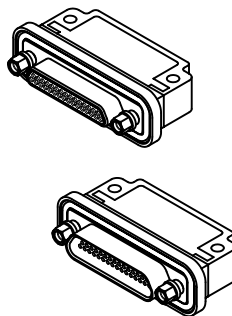

Rear Panel Mount
Sizes: 9 thru 100
Page: M-122.1 & M-122.4

**Micro-D
Connectors
Sealing**

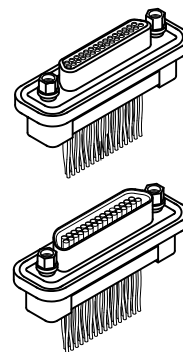

Rugged, I/O
Sizes: 9 thru 100
Page: M-125

**Micro-D
Connectors
Grounding
Fingers**

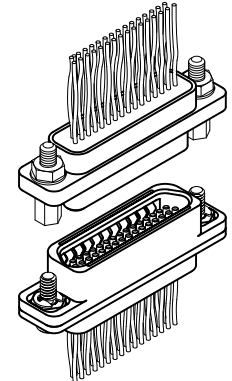

Rugged, I/O
Sizes: 9 thru 100
Page: M-36.1

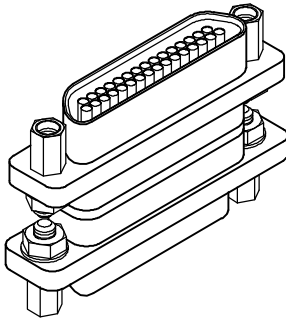

Rugged
Sizes: 9 thru 100
Page: MA-11

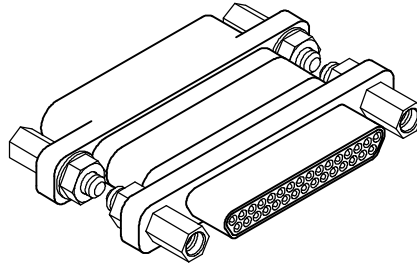

Low Profile
Sizes: 9 thru 51
Page: MA-13

**Micro-D
Connectors
Connector Savers**

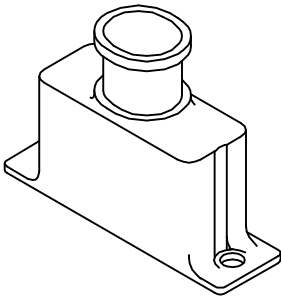

Rugged
Page MA-15

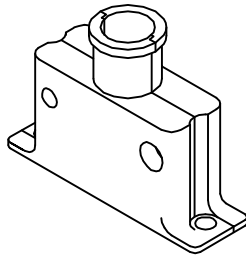

Low Profile
Page MA-21

**EMI / RFI Straight
Backshells**

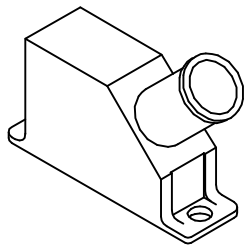

Rugged
Page MA-17

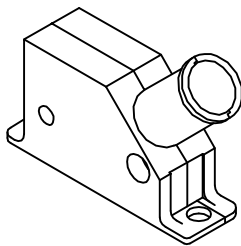

**Micro-D
EMI / RFI 45°
Backshells**

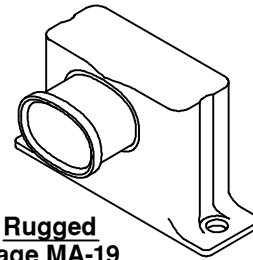

Rugged
Page MA-19

**Micro-D
EMI / RFI 90°
Backshells**

**Integral Shield
Termination**

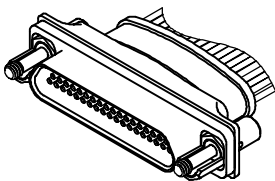

Rugged
Page M-36.3

**Integral Shield
Termination
with Solder Cups**

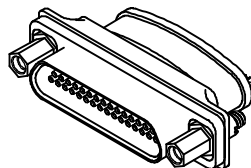

Rugged
Page M-36.5

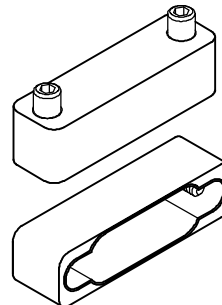

Rugged
Page MA-23

**Dust
Covers**

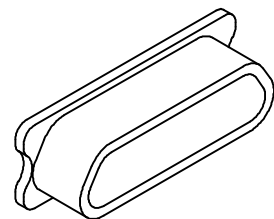

**ESD
Rugged & Low Profile**
Page MA-25

Contents

"M" Series

.050" Microminiature PCB and I/O Connectors

M-1	Index
M-5	Contents
M-6	Specifications
M-7	Performance
M-8	Part number description
M-9	Mating matrix

Micro-Strip Connectors (Plastic)

M-11	MA-1	1-row, cable to cable
M-13	MA-1	1-row, board to cable
M-15	MA-1	1-row, MA strip guidelines
M-16	MA-1	1-row, board layouts
M-23	MA-2	2-row, cable to cable
M-25	MA-2	2-row, board to cable
M-28	MA-2	2-row, MA strip guidelines
M-29	MA-2	2-row, board layouts

Micro-D Cable to Cable Connectors (Metal and Plastic)

M-35	MM-MM, MN-MN	Rugged
M-36.1	MM	Rugged, Grounding Fingers
M-36.3	MM	Rugged, Integrated Shield Termination - Stranded Wire
M-36.5	MM	Rugged, Integrated Shield Termination - Stranded Wire
M-37	MM, MN	Rugged, Jumper Assembly
M-39	MQ-MQ, MP-MP	Low Profile
M-41	MQ, MP	Low Profile, Jumper Assembly
M-43	MK, ML	Rugged Right Angle, Narrow Footprint
M-45	MK	Rugged Right Angle, Thru Clearance
M-47	MK	Rugged Right Angle, Blind Clearance
M-49	MK, ML	Rugged, Flex Cable
M-51	MS, MR	Low Profile Right Angle, Narrow Footprint
M-53	MS	Low Profile Right Angle, Blind Clearance
M-55	MS, MR	Low Profile, Flex Cable
M-57	MK, ML, MS, MR	Board Layouts - Right Angle Narrow Footprint
M-60.1	MK	Rugged Right Angle, Compressed Footprint
M-60.3	MK	Board Layouts - Right Angle Compressed Footprint
M-61, M-63	MK-MM, ML-MN	Rugged Right Angle, Standard Footprint
M-65	MK, ML	Board Layouts - Right Angle Standard Footprint
M-67, M-69	MK-MM, ML-MN	Rugged Straight, Narrow Footprint
M-71	MK, ML	Board Layouts - Straight Narrow Footprint
M-73, M-75	MK-MM, ML-MN	Rugged Straight, Standard Footprint
M-77	MK, ML	Board Layouts - Standard Narrow Footprint

Micro-D Surface Mount Board to Cable Connectors

M-81	MM, MN	Specifications, SMT Connectors
M-82	MM, MN	Performance, SMT Connectors
M-83, 85	MM-MM, MN-MN	Rugged Horizontal SMT
M-87	MM, MN	Board layouts - Rugged Horizontal SMT
M-89, 91	MK-MM	Rugged Vertical SMT
M-93	MK	Board layouts - Rugged Vertical SMT
M-95, 97	MK-MM	Rugged Card Edge Mount
M-99	MK	Board layouts - Rugged Card Edge Mount

Micro-D Filtered Cable Connectors

M-103	MF	Rugged metal
-------	----	--------------

Micro-D Hybrid Connectors

M-105	MM	Specifications, Rugged Hybrid Connectors
M-106	MM	Performance, Rugged Hybrid Connectors
M-107	MM	Rugged Hybrid

Micro-Circular Connectors

M-109	MC-MC	Rugged metal, quick release
-------	-------	-----------------------------

Micro-D Rear Panel Mount Connectors

M-111	MK-MM, MK-MN	Specifications, Rear Panel Mount
M-112	MK-MM, MK-MN	Performance, Rear Panel Mount
M-113, 115	MM, MN	Rugged, Cable to Cable Rear Panel Mount
M-117, 119	MK-MM, MK-MN	Rugged, Board to Cable Rear Panel Mount
M-121	MK	Board Layouts - Straight, Standard Footprint
M-122.1	MK	Rugged Right Angle, Rear Panel Mount
M-122.3	MK	Board Layouts - Rugged Right Angle

Micro-D Sealed Connectors

M-123	MM	Specifications, Sealed
M-124	MM	Performance, Sealed
M-125	MM	Rugged, Metal I/O Sealed

Specifications

Materials and Finishes *

Contacts:	Pins: BeCu alloy strip per ASTM B194 Sockets: Brass per ASTM B121 / B121M or ASTM B16 / B16M or ASTM B453
Contact Finish:**	Gold plate per ASTM B488
Shells:	Aluminum Alloy 6061-T6 per SAE AMS-QQ-A-250/11 or 6061-T6511 per SAE AMS-QQ-A-200/8 or Stainless Steel 300 series per ASTM A484 / A484M and ASTM A582 / A582M Passivated per SAE AMS2700
Aluminum Shell Finishes:**	Electroless Nickel per SAE AMS2404, Class 3, 500 μ " min Electrodeposited Cadmium per SAE AMS-QQ-P-416, Type II, Class 3 Black Anodized per MIL-A-8625, Type III, Class 2 Gold per MIL-DTL-45204, Type II, Grade C, Class 0
Molded Insulators:	Glass filled polyphenylene sulfide per MIL-M-24519
Embedment:	Frey Engineering Co. insulating compound CF3003-80 and L-II-49 or equivalent
Jackscrews, Jackposts and Nuts:	Corrosion resistant steel per ASTM A320 or ASTM A484 / A484M and ASTM A582 / A582M Passivated per SAE AMS2700
Clips and Washers:	Corrosion resistant steel per ASME 18.24 or NASM35333 or ASTM A484/A484M and ASTM A582/A582M (For reference only: ASME 18.24 CRS per ASTM A693 and NASM35333 CRS per ASTM A240) Passivated per ASME 18.24 or NASM35333 or SAE AMS2700 (For reference only: ASME 18.24 and NASM35333 passivated per SAE AMS2700)
Guide Pins	Corrosion resistant steel per ASTM A484 / A484M and ASTM A582 / A582M Passivated per SAE AMS2700
Latches	Beryllium copper in accordance with ASTM B194 Electroless Nickel plate per SAE AMS2404
Interfacial Seal Gaskets:	Fluorosilicone per SAE AMS-R-25988
Tolerances:**	Unless otherwise specified: Fractions = $\pm 1/64$ " Decimals = $\pm .010$ " Angles = $\pm 5^\circ$ Wire lengths: insulated/stranded = $+1.0"/-0.0$ " uninsulated/solid = $+0.2"/-0.0$ "

Note: AirBorn can manufacture special configurations for your exact specifications.

* = Reference the above listed specifications or an equivalent industry standard when applicable

** = When ordering to Mil Spec P/N, Mil Spec requirements apply



Performance

Reference MIL-DTL-83513

AirBorn "M" Series meets or exceeds MIL-DTL-83513 Performance Specifications

Contact Rating:	3-amperes maximum
Solderability:	Terminals (except crimp) tested in accordance with MIL-STD-202, Method 208
Wire Size:	Stranded #26 AWG or solid #25 AWG standard (consult factory for other sizes and types)
Test Voltage:	600 V, RMS, 60 Hz
Operating Temperature:	-55° C to +125° C
Insulation Resistance:	5,000 megohms minimum @ 500 VDC
Durability:	500 connector mating cycles
Vibration:	Tested in accordance with MIL-STD-1344, Method 2005, Condition IV, according to MIL-83513
Shock:	Tested in accordance with MIL-STD-1344, Method 2004, Condition E, according to MIL-83513
Salt Spray:	Mated connectors tested in accordance with MIL-STD-1344, Method 1001, Test Condition B
Humidity:	Mated connectors tested in accordance with MIL-STD-1344, Method 1002, Type II (except steps 7a and 7b)
Thermal Shock:	Tested to the temperature extremes of MIL-STD-1344, Method 1003, Test Condition A (except step 3, temperature shall be 125° C)
Contact Resistance:	0.065 volt maximum drop @ 2.5 amps (.026 ohms)
Contact Engaging Force:	6.0 ounce maximum, with .0221 diameter test sleeve per contact
Contact Separating Force:	0.5 ounce minimum, with .0230 diameter test sleeve per contact
Crimp Strength:	5 pound minimum tensile strength
Mating & Unmating Force:	10 ounces maximum per contact

Call (972) 931-3200 · Fax (972) 931-9305 · www.AirBorn.com

Part Number Description

Each part number consists of at least five elements: series, body description, size (number of contacts), type of contacts, and type of hardware. A sixth element is added whenever special modifications or options are available.

Each catalog page shows the choices available for each of these elements. By selecting one option from each category on the page, you can build a set of connectors to meet your requirements.

Each element is identified by a combination of letters and/or numbers in fixed field lengths, and separated by a hyphen (-). Each space must be filled in to complete the number. When the size, for example, is less than 100, indicate as 009, 051, etc.

Series:

This will always be a two letter designator, and will identify the connector series. All .050" connectors begin with the letter "M". The second letter designates the various styles of .050" connectors.

Body:

Each digit of the Body Designator will normally identify (1) the number of rows, (2) the style of body, and (3) the body materials. The three digit number to identify the body consists of one digit from each group.

Size:

The size is determined by the number of contacts in the connector, and is an integral part of the part number. Order only sizes shown on the catalog page unless otherwise noted.

Contacts:

Each page also identifies all contact options for a given connector. The first two digits designate the type of contacts and terminations; the third digit designates the plating option.

Hardware:

The hardware designator is four digits; two for style of hardware and two for polarization or wiring instruction. Follow the choices for each connector.

Special Instructions (Options):

Special instructions are referenced by a three or four digit number added to the end of the part number. The last three or four digits are included only when applicable. AirBorn will provide individual code numbers as needed.

Note:

Each page is as comprehensive as possible. However, if you do not find a particular connector size or option, please contact the factory for further assistance.

Symbolizes options that are not RoHS compliant.

Mating Matrix for AirBorn "M" Series Connectors

RECEPTACLES

P
L
U
G
S

	MA (Strip)	MC (Circular)	MM (Hybrid)	MK (Metal) PC Board	ML (Plastic) PC Board	MM (Metal) I/O	MN (Plastic) I/O	MP (Plastic) I/O	MQ (Metal) I/O	MR (Plastic) PC Board	MS (Metal) PC Board
MA (Strip)	XX										
MC (Circular)		XX									
MM (Hybrid)			XX								
MK (Metal) PC Board				BB	BB	BI	BI				
ML (Plastic) PC Board				BB	BB	BI	BI				
MM (Metal) I/O				IB	IB	II	II				
MN (Plastic) I/O				IB	IB	II	II				
MP (Plastic) I/O								II	II	IB	IB
MQ (Metal) I/O								II	II	IB	IB
MR (Plastic) PC Board								BI	BI	BB	BB
MS (Metal) PC Board								BI	BI	BB	BB

KEY:

BB = PC Board Mounted Plug with PC Board Mounted Receptacle

BI = PC Board Mounted Plug with I/O Receptacle

IB = I/O Plug with PC Board Mounted Receptacle

II = I/O Plug with I/O Receptacle

For Military Configurations, See pages MIL-1 thru MIL-22

I/O Connectors

MM-MN-MP-MQ

PC Board Mounted Connectors

MK-ML-MR-MS

Inter-mateable Connectors

MK-ML-MM-MN
MP-MQ-MR-MS

MA-131-010-161-A69WQ

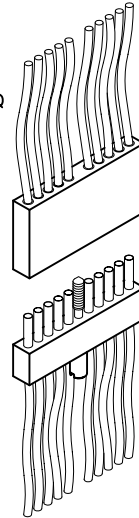

MA-141-010-261-A72WQ

1 • ROW Strip Connectors Cable to Cable

.050"

MA-1

2 thru 60 Contacts

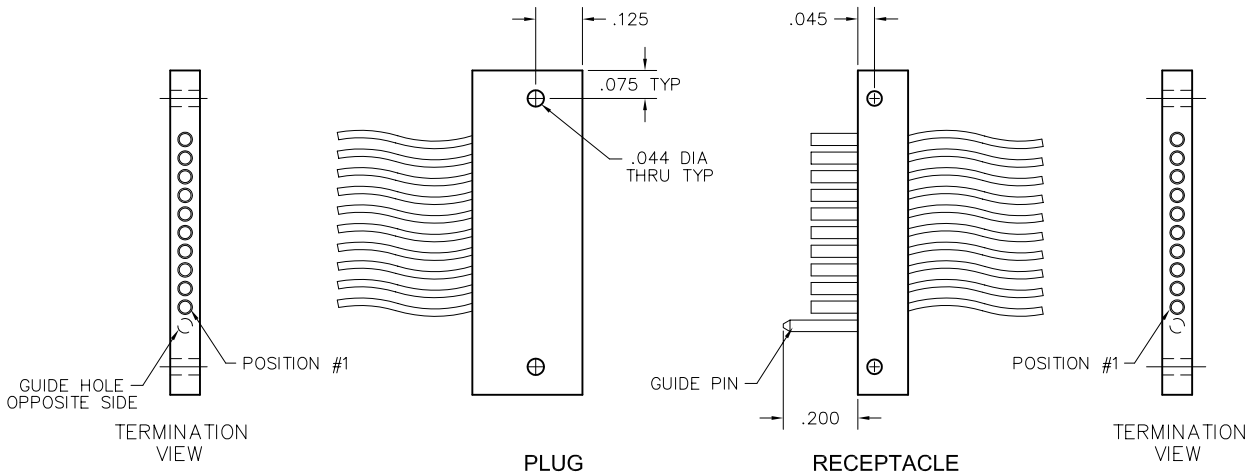
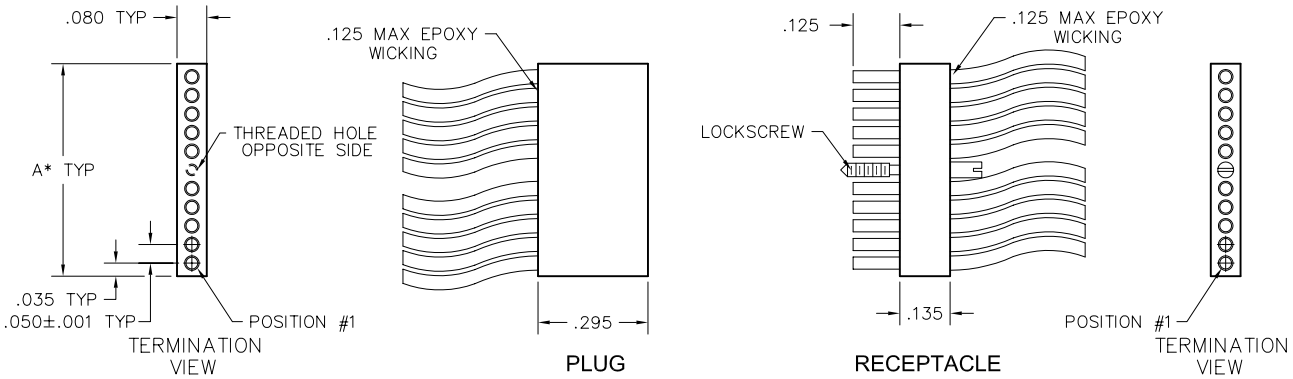

OPTIONAL MOUNTING HOLES & GUIDE PIN

DIMENSIONS	
To determine connector length (Dim "A"):	
Multiply the number of cavities in one row by .050" "
Add fixed end lengths (constant, .010" x 2) 0.02"
Add .150" for each mounting hole "
Total Length: "
Notes:	
Length over 2" may require support to insure alignment.	
When using one lock screw, use centermost available hole.	
* = Maximum length is 3.020". Maximum number of contacts must be reduced to accommodate hardware and mounting holes.	

PLUG: MA-131-010-161-A69WQ
RECEPTACLE: MA-141-010-261-A72WQ
 XX-XXX-XXX-XXX-XXXXX

PLUG

RECEPTACLE

SERIES

MA .050" Microminiature Strip Connector | MA .050" Microminiature Strip Connector

BODY

1	1-Row	1	1-Row
BODY STYLE: (Material: Polyphenylene sulfide)		BODY STYLE: (Material: Polyphenylene sulfide)	
11	Plug, straight, with mounting holes	21	Receptacle, straight, with mounting holes
31	Plug, straight, without mounting holes	41	Receptacle, straight, without mounting holes

SIZE

XXX 002 - 060 | XXX 002 - 060
 Note: Maximum number of contacts is reduced when using hardware or mounting holes. See dimension chart on M-11.

CONTACTS

TYPE CONTACTS/TERMINATIONS:		TYPE CONTACTS/TERMINATIONS:	
11	Pin, straight, solder cup	21	Socket, straight, solder cup
14	Pin, straight, .500" pigtails (.018 dia)	24	Socket, straight, .500" pigtails (.018 dia)
15	Pin, straight, 1.000" pigtails (.018 dia)	25	Socket, straight, 1.000" pigtails (.018 dia)
16	Pin, straight, crimped wire	26	Socket, straight, crimped wire

PLATING OPTIONS:		PLATING OPTIONS:	
1	50 μ" Au contacts (crimp wire)	1	50 μ" Au contacts (crimp wire)
3	50 μ" Au contacts; 10 μ" Au terminations (solder cup, pigtail)	3	50 μ" Au contacts; 10 μ" Au terminations (solder cup, pigtail)
5	50 μ" Au contacts; Sn/Pb alloy terminations (pigtail) <input checked="" type="checkbox"/>	5	50 μ" Au contacts; Sn/Pb alloy terminations (pigtail) <input checked="" type="checkbox"/>
7	50 μ" Au contacts; SAC305 terminations (pigtail)	7	50 μ" Au contacts; SAC305 terminations (pigtail)

HARDWARE

STYLE OF HARDWARE:		STYLE OF HARDWARE:	
A00	None	A00	None
A01-A49	Latch box, side mounted (cavity number location)	A01-A49	Latch spring, side mounted (cavity number location)
A50	Latch boxes (two end cavities)	A51	Latch springs (two end cavities)
A64	One guide hole (centered)*	A61	One guide pin (centered)*
A65	One guide hole (first cavity)	A62	One guide pin (first cavity)
A66	One guide hole (last cavity)	A63	One guide pin (last cavity)
A68	Two guide holes (two end cavities)	A67	Two guide pins (two end cavities)
A69	One threaded hole (centered)*	A72	One lockscrew (centered)*, uninstalled
AHX	One guide hole (cavity #2 - #9)	APX	One guide pin (cavity #2 - #9)
ATX	One threaded hole (cavity #2 - #9)	ALX	One lockscrew (cavity #2 - #9), uninstalled

POLARIZATION / WIRING:		POLARIZATION / WIRING	
00	None	00	None
XX	For wiring codes, see pages MA-3 & MA-4	XX	For wiring codes, see pages MA-3 & MA-4

* = To determine location, divide the total number of cavities by two and round to the next whole number, if result is a fraction. See page M-15. See MA strip guidelines, page M-15, for location examples & visual clarification.

= Option not RoHS compliant

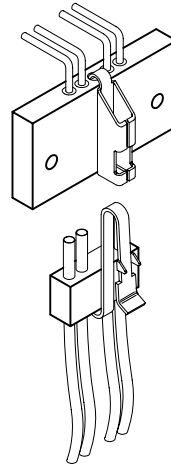

1 • ROW Strip Connectors Board to Cable

.050"

MA-1

2 thru 60 Contacts

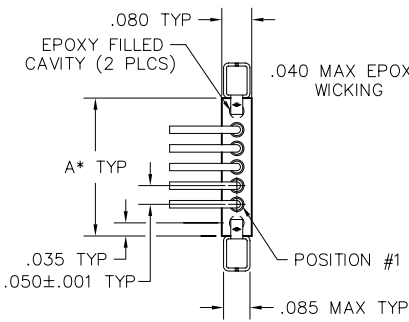

TERMINATION VIEW

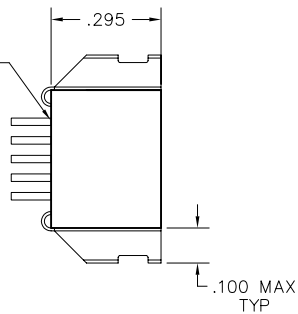

PLUG

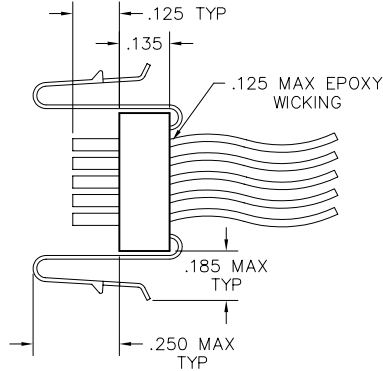

RECEPTACLE

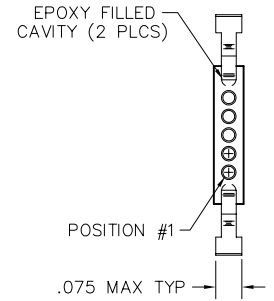

TERMINATION VIEW

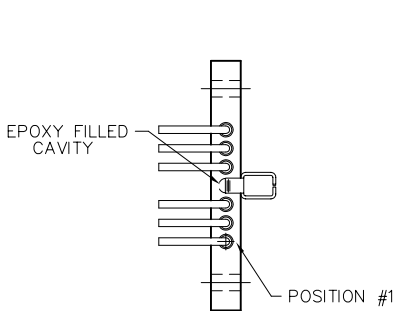

TERMINATION VIEW

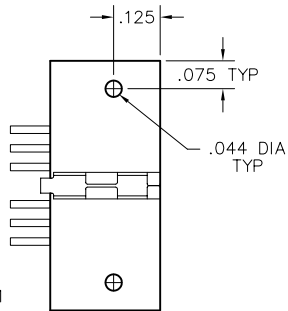

PLUG

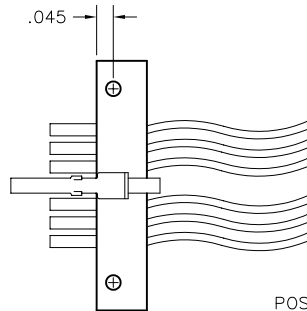

RECEPTACLE

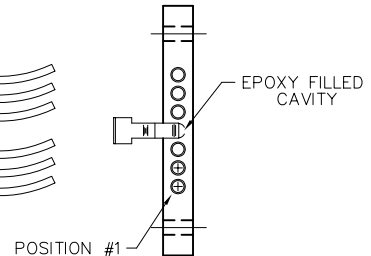

TERMINATION VIEW

OPTIONAL MOUNTING HOLES

DIMENSIONS

To determine connector length (Dim "A"):

Multiply the number of cavities in one row by .050"	. "
Add fixed end lengths (constant, .010" x 2)	0.02"
Add .150" for each mounting hole	. "
Total Length:	. "

Notes:
 Length over 2" may require support to insure alignment.
 When using one lock screw, use centermost available hole.
 * = Maximum length is 3.020". Maximum number of contacts must be reduced to accommodate hardware and mounting holes.

LEAD CONFIGURATION OPTIONS

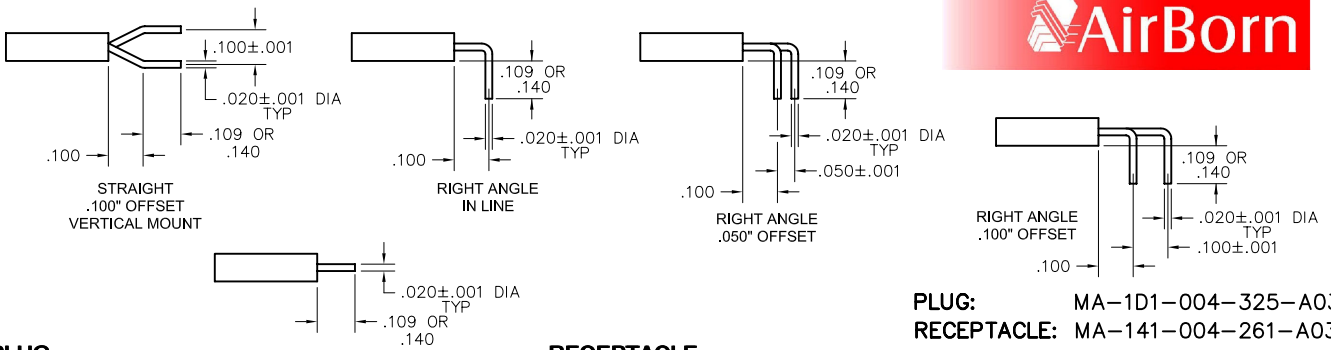

PLUG: MA-1D1-004-325-A0300
RECEPTACLE: MA-141-004-261-A03WS
 XX-XXX-XXX-XXX-XXXXX

PLUG		RECEPTACLE	
SERIES			
MA .050" Microminiature Strip Connector		MA .050" Microminiature Strip Connector	
BODY			
1 1-Row	BODY STYLE: (Material: Polyphenylene sulfide)	1 1-Row	BODY STYLE: (Material: Polyphenylene sulfide)
11 Plug, straight, with mounting holes		21 Receptacle, straight, with mounting holes	
31 Plug, straight, without mounting holes		41 Receptacle, straight, without mounting holes	
51 Plug, right angle, .050" offset, with mounting holes		61 Receptacle, right angle, .050" offset, with mounting holes	
71 Plug, right angle, .100" offset, with mounting holes		81 Receptacle, right angle, .100" offset, with mounting holes	
91 Plug, right angle, .050" offset, without mounting holes		A1 Receptacle, right angle, .050" offset, without mounting holes	
B1 Plug, right angle, .100" offset, without mounting holes		C1 Receptacle, right angle, .100" offset, without mounting holes	
D1 Plug, right angle, in line, with mounting holes		E1 Receptacle, right angle, in line, with mounting holes	
F1 Plug, right angle, in line, without mounting holes		G1 Receptacle, right angle, in line, without mounting holes	
H1 Plug, straight, .100" offset, without mounting holes		J 1 Receptacle, straight, .100" offset, without mounting holes	
SIZE			
XXX 002 - 060		XXX 002 - 060	
Note: Maximum number of contacts is reduced when using hardware or mounting holes. See dimension chart on M-13.			
CONTACTS			
TYPE CONTACTS/TERMINATIONS:		TYPE CONTACTS/TERMINATIONS:	
11 Pin, straight, solder cup		21 Socket, straight, solder cup	
12 Pin, straight, PCB leads, .109"		22 Socket, straight, PCB leads, .109"	
13 Pin, straight, PCB leads, .140"		23 Socket, straight, PCB leads, .140"	
14 Pin, straight, .500" pigtails (.018 dia)		24 Socket, straight, .500" pigtails (.018 dia)	
15 Pin, straight, 1.000" pigtails (.018 dia)		25 Socket, straight, 1.000" pigtails (.018 dia)	
16 Pin, straight, crimped wire		26 Socket, straight, crimped wire	
32 Pin, right angle, PCB leads, .109"		43 Socket, right angle, PCB leads, .109"	
33 Pin, right angle, PCB leads, .140"		44 Socket, right angle, PCB leads, .140"	
PLATING OPTIONS:		PLATING OPTIONS:	
1 50 μ" Au contacts (crimp wire)		1 50 μ" Au contacts (crimp wire)	
3 50 μ" Au contacts; 10 μ" Au terminations (solder cup, pigtail, PCB leads)		3 50 μ" Au contacts; 10 μ" Au terminations (solder cup, pigtail, PCB leads)	
5 50 μ" Au contacts; Sn/Pb alloy terminations (dip solder, pigtail, PCB leads) ☒		5 50 μ" Au contacts; Sn/Pb alloy terminations (dip solder, pigtail, PCB leads) ☒	
7 50 μ" Au contacts; SAC305 terminations (pigtail, PCB leads)		7 50 μ" Au contacts; SAC305 terminations (pigtail, PCB leads)	
HARDWARE			
STYLE OF HARDWARE:		STYLE OF HARDWARE:	
A00 None		A00 None	
A01-A49 Latch box, side mounted (cavity number location)		A01-A49 Latch spring, side mounted (cavity number location)	
A50 Latch boxes (two end cavities)**		A51 Latch springs (two end cavities)**	
A64 One guide hole (centered)*		A61 One guide pin (centered)*	
A65 One guide hole (first cavity)		A62 One guide pin (first cavity)	
A66 One guide hole (last cavity)		A63 One guide pin (last cavity)	
A68 Two guide holes (two end cavities)		A67 Two guide pins (two end cavities)	
A69 One threaded hole (centered)*		A72 One lockscrew (centered)*	
AHX One guide hole (cavity #2 - #9)		APX One guide pin (cavity #2 - #9)	
ATX One threaded hole (cavity #2 - #9)		ALX One lockscrew (cavity #2 - #9)	
POLARIZATION / WIRING:		POLARIZATION / WIRING	
00 None		00 None	
XX For wiring codes, see pages MA-3 & MA-4		XX For wiring codes, see pages MA-3 & MA-4	

* = To determine location, divide the total number of cavities by two and round to the next whole number, if result is a fraction. See page M-15.

** = Not available with mounting holes.

See MA strip guidelines, page M-15, for location examples & visual clarification.

☒ = Option not RoHS compliant



1 • ROW Strip Connectors with Latches

.050"

MA-1

3 thru 60 Contacts

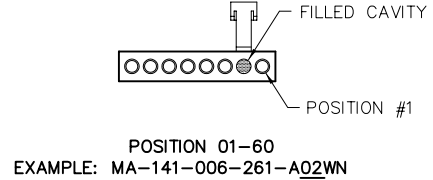
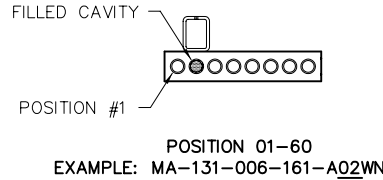
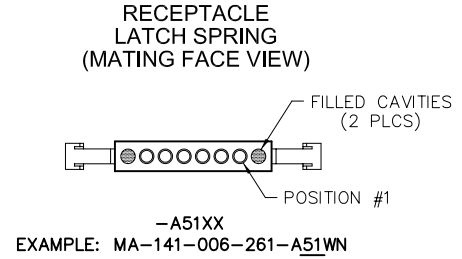
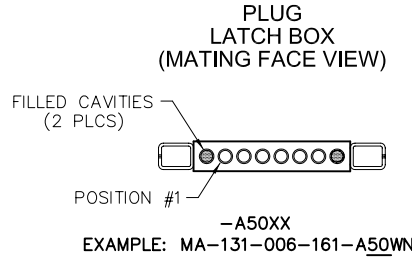

MA Strip Guidelines

For "A" designator in hardware portion of part number

1. Any cavity that has a contact is considered an electrical position (including dummy contact).
2. All hardware locations, holes and/or epoxy filled cavities are considered mechanical positions.
3. Omit holes on board layout for mechanical positions and renumber board layout accordingly, except connectors with mechanical position(s) in end cavity(ies).
See board layout examples, pages M-16 thru M-22.
4. These guidelines apply for all hardware options, including guide holes (mechanical locations).
5. Do not skip wire colors on stranded wire assemblies.
6. Spacers underneath the connector are recommended when R/A PCB mount connectors with mounting holes are used and the PCB had irregularities greater than .004" underneath the connector.

To determine hardware location number:

1. Divide the total number of cavities by two (including hardware cavity).
2. Round to the next whole number if result is a fraction.

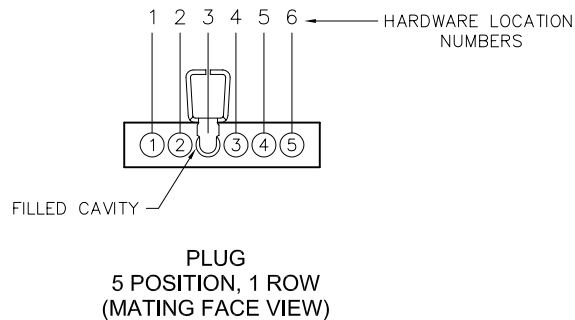

The connector above has 6 cavities with 5 live contacts.
(5 electrical positions & 1 mechanical position)

To determine the hardware location number:
6 cavities ÷ 2 = 3
Hardware would be placed in location #3

Board mount connectors, right angle offset (.100") with mounting holes (6 electrical positions)

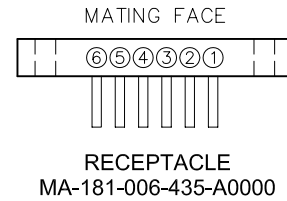
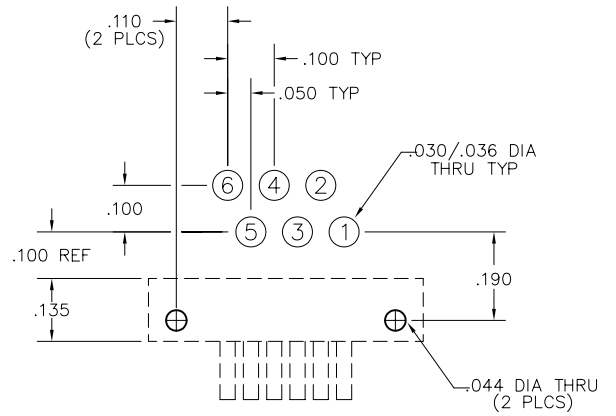
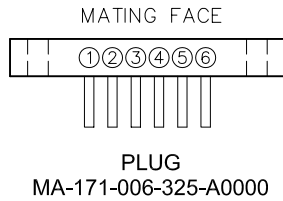
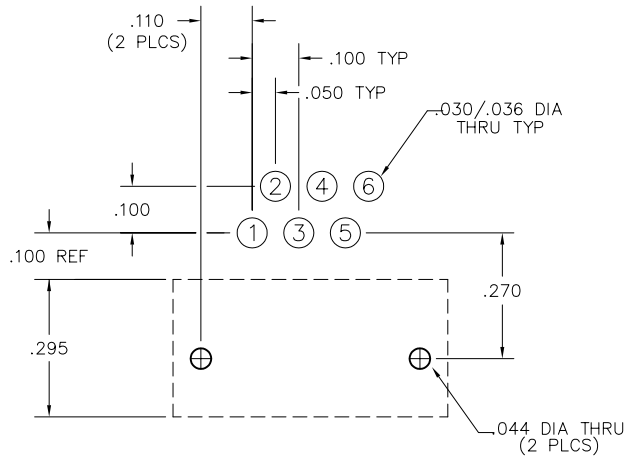

Crimped wire connectors, straight without mounting holes (6 electrical positions)

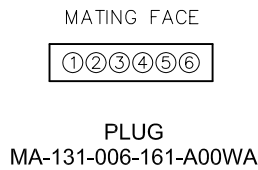

WIRE CONNECT CHART

1	—	BLK
2	—	BRN
3	—	RED
4	—	ORN
5	—	YEL
6	—	GRN

**Board mount connectors, right angle offset (.100") with mounting holes.
Side mount latch, centered.**

(5 electrical positions, 1 mechanical positions)

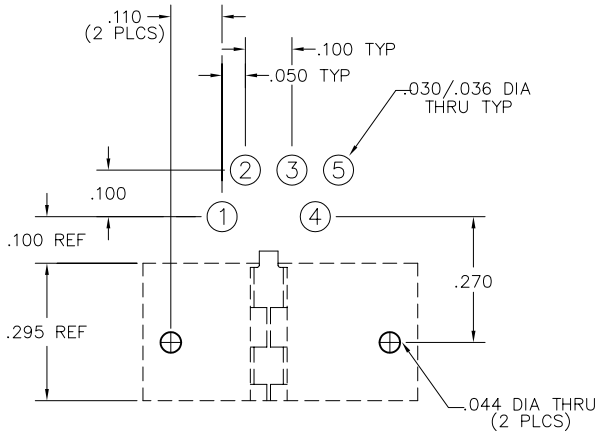

MATING FACE

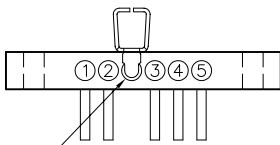

FILLED CAVITY

PLUG
MA-171-005-325-A0300

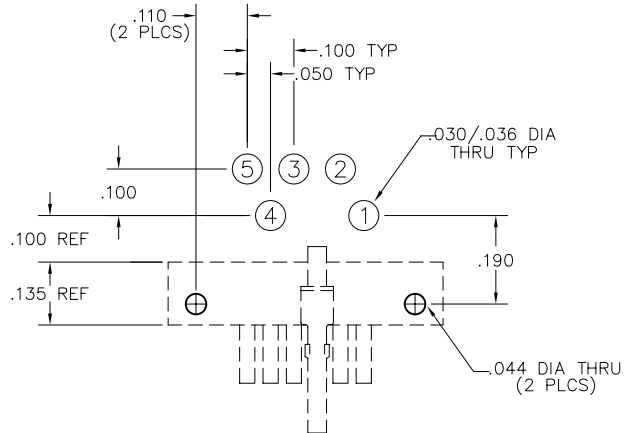

MATING FACE

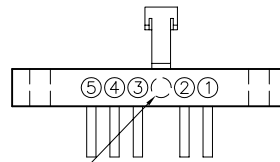

FILLED CAVITY

RECEPTACLE
MA-181-005-435-A0300

**Crimped wire connectors, straight with mounting holes.
Side mount latch, centered.**

(5 electrical positions, 1 mechanical positions)

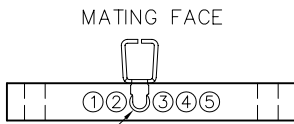

MATING FACE

FILLED CAVITY

PLUG
MA-111-005-161-A03WA

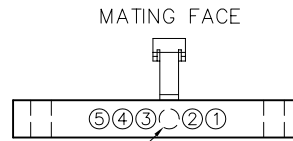

MATING FACE

FILLED CAVITY

RECEPTACLE
MA-121-005-261-A03WA

WIRE CONNECT CHART

- 1 — BLK
- 2 — BRN
- 3 — RED
- 4 — ORN
- 5 — YEL

Board mount connectors, right angle offset (.100") without mounting holes End mount latches, 2 end cavities*

(6 electrical positions, 2 mechanical positions)

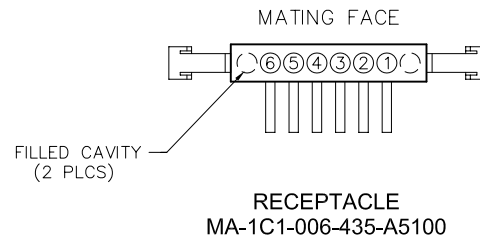
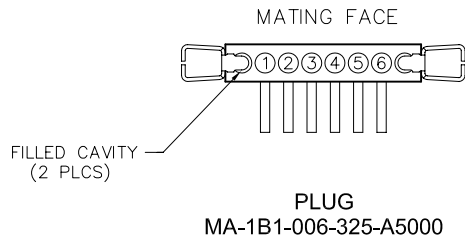
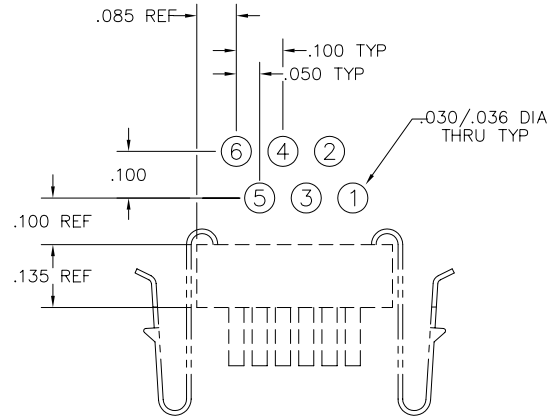
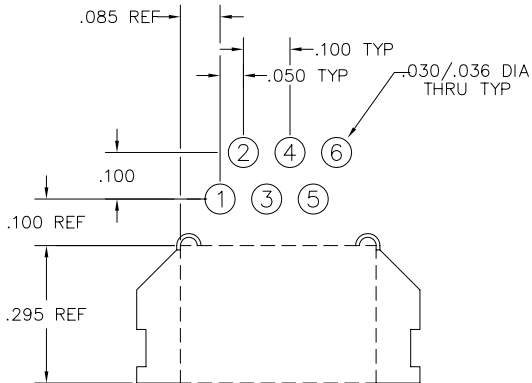

* = THIS IS THE EXCEPTION AS NOTED IN "MA STRIP GUIDELINES", PAGE M-15, NOTE 3.

Crimped wire connectors, straight without mounting holes End mount latches, 2 end cavities

(3 electrical positions, 2 mechanical positions)

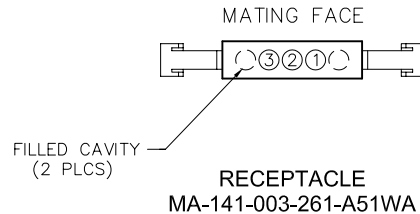
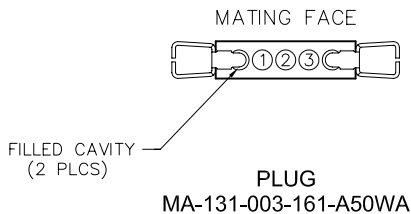

WIRE CONNECT CHART

- 1 — BLK
- 2 — BRN
- 3 — RED



Board mount connectors, right angle inline (.100") with mounting holes Side mount latch, centered

(5 electrical positions, 1 mechanical positions)

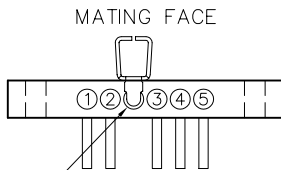
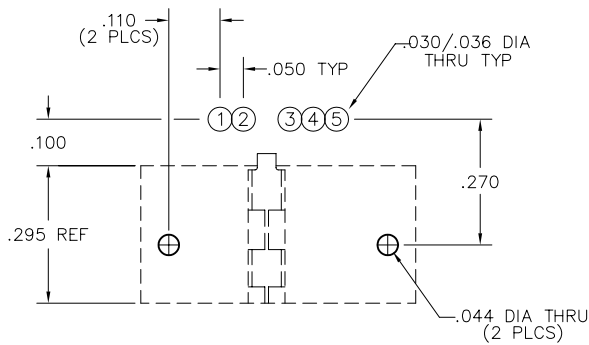

FILLED CAVITY

PLUG
MA-1D1-005-325-A0300

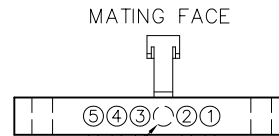
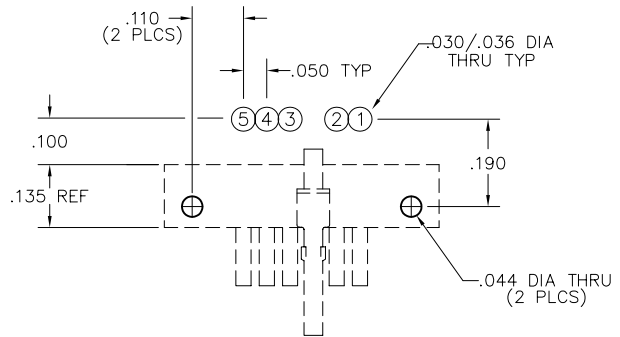

FILLED CAVITY

RECEPTACLE
MA-1E1-005-435-A0300

Crimped wire connectors, straight without mounting holes Side mount latch, centered

(5 electrical positions, 1 mechanical positions)

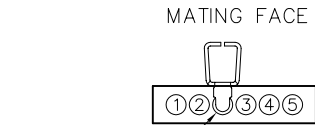

FILLED CAVITY

PLUG
MA-131-005-161-A03WA

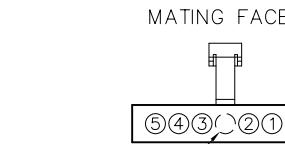

FILLED CAVITY

RECEPTACLE
MA-141-005-261-A03WA

WIRE CONNECT CHART

- 1 — BLK
- 2 — BRN
- 3 — RED
- 4 — ORN
- 5 — YEL

Board mount connectors, straight offset (.100") without mounting holes

Two guide holes/two end cavities

(4 electrical positions, 2 mechanical positions)

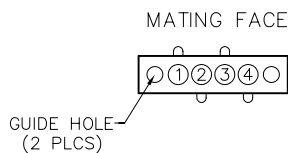
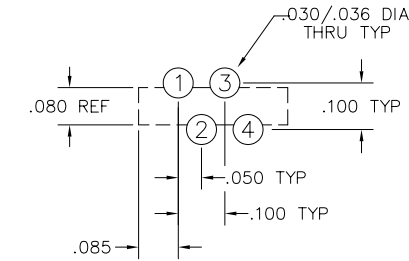

PLUG
MA-1H1-004-145-A6800

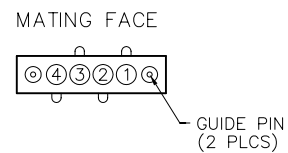
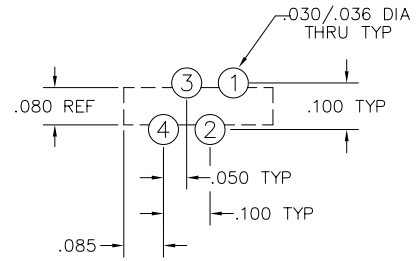

RECEPTACLE
MA-1J1-004-245-A6700

Board mount connectors, straight without mounting holes

One guide hole/pin, first cavity

(5 electrical positions, 1 mechanical position)

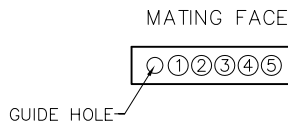

PLUG
MA-131-005-125-A6500

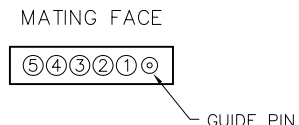

RECEPTACLE
MA-141-005-225-A6200

Crimped wire connectors, straight without mounting holes

Two guide holes/two end cavities

(4 electrical positions, 2 mechanical positions)

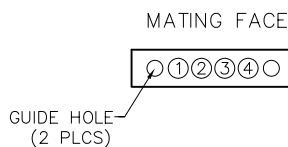

PLUG
MA-131-004-161-A68WA

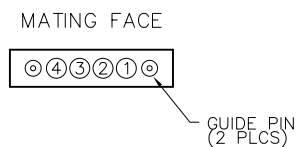

RECEPTACLE
MA-141-004-261-A67WA

WIRE CONNECT CHART

- 1 — BLK
- 2 — BRN
- 3 — RED
- 4 — ORN

Board mount connectors, right angle offset (.050") with mounting holes

Guide hole/pin, last cavity

(5 electrical positions, 1 mechanical positions)

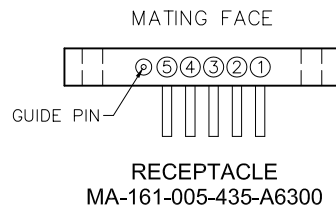
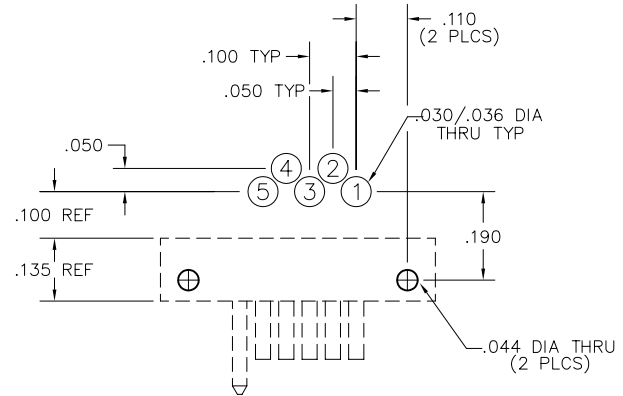
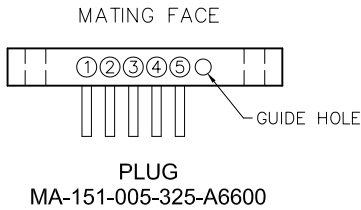
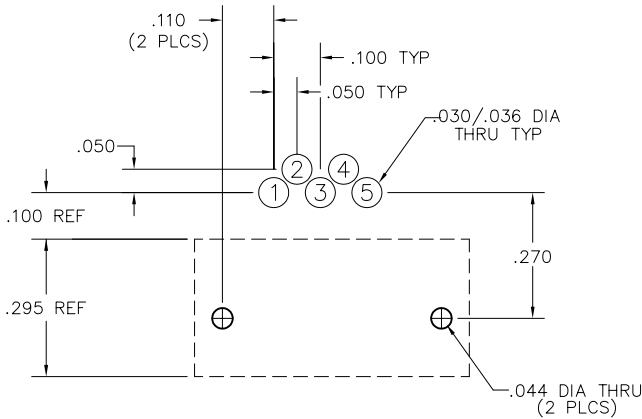

Crimped wire connectors, straight with mounting holes

Guide hole/pin, last cavity

(5 electrical positions, 1 mechanical positions)

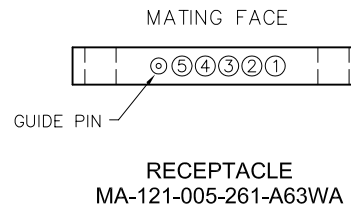
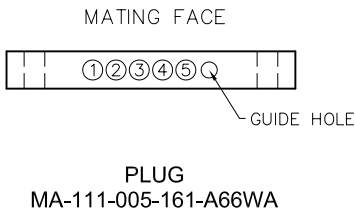

WIRE CONNECT CHART

- 1 — BLK
- 2 — BRN
- 3 — RED
- 4 — ORN
- 5 — YEL

Board mount connectors, right angle offset (.050") without mounting holes

Guide hole/pin, first cavity*

(5 electrical positions, 1 mechanical positions)

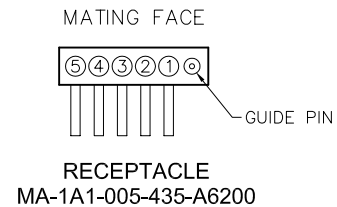
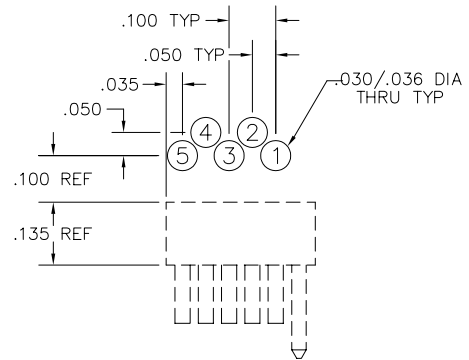
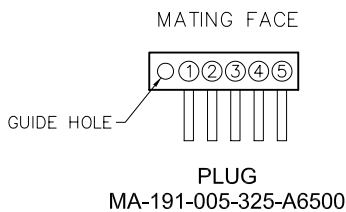
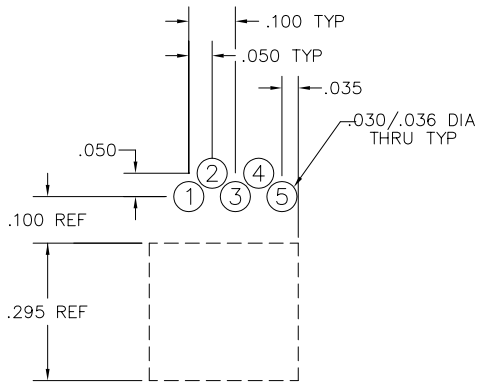

* = THIS IS THE EXCEPTION AS NOTED IN "MA STRIP GUIDELINES", PAGE M-15, NOTE 3.

Crimped wire connectors, straight without mounting holes

Guide hole/pin, first cavity

(5 electrical positions, 1 mechanical positions)

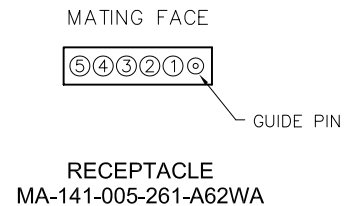
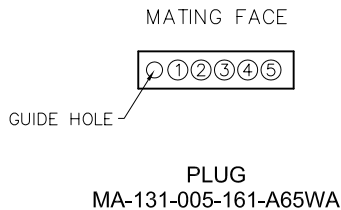

WIRE CONNECT CHART

- 1 — BLK
- 2 — BRN
- 3 — RED
- 4 — ORN
- 5 — YEL

MA-231-016-161-A64WS

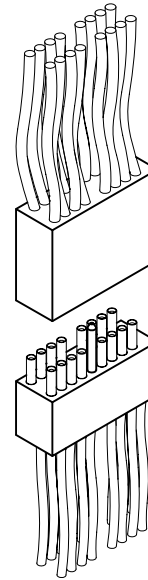

MA-241-016-261-A61WS

2 · ROW Strip Connectors Cable to Cable

.050"

MA-2

4 thru 128 Contacts

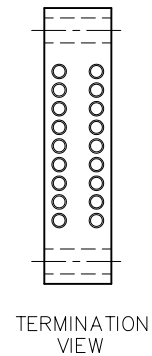
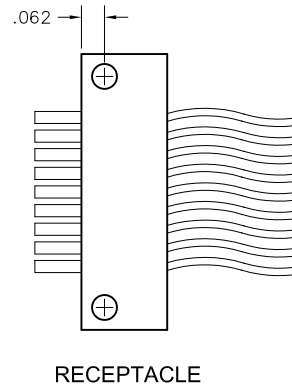
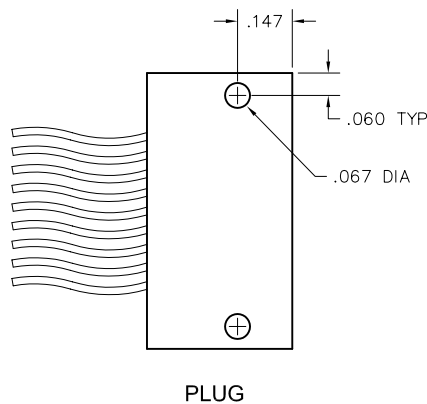
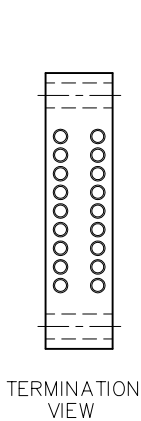
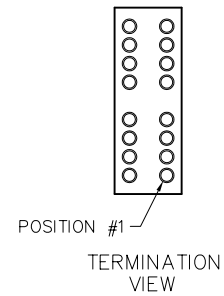
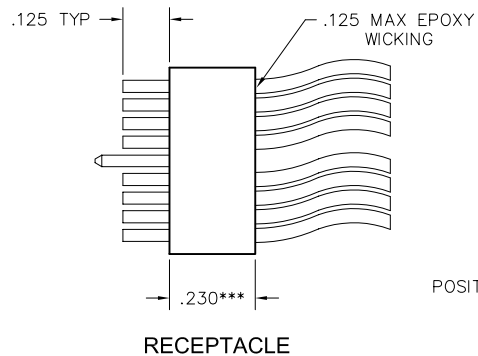
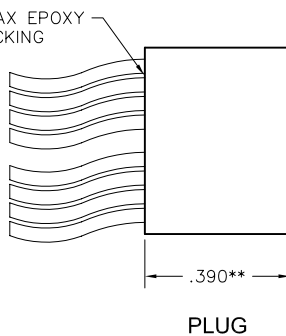
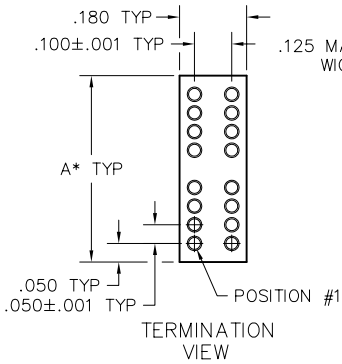

OPTIONAL MOUNTING HOLES

DIMENSIONS

To determine connector length (Dim "A"):
 Multiply the number of cavities in one row by .050" . "
 Add fixed end lengths (constant, .025" x 2) 0.05"
 Add .085" for each mounting hole . "
 Total Length: . "

Notes:

- Length over 2" may require support to insure alignment.
- * = Maximum length is 3.420". Maximum number of contacts must be reduced to accommodate hardware and mounting holes.
- ** = For solder cup or board mount applications, .390" becomes .295"
- *** = For solder cup or board mount applications, .230" becomes .135"

PLUG: MA-231-016-161-A64WS
RECEPTACLE: MA-241-016-261-A61WS
 XX-XXX-XXX-XXX-XXXXX

PLUG

RECEPTACLE

SERIES

MA .050" Microminiature Strip Connector | MA .050" Microminiature Strip Connector

BODY

2 2-Row | 2 2-Row

BODY STYLE: (Material: Polyphenylene sulfide) | BODY STYLE: (Material: Polyphenylene sulfide)

11 Plug, straight, with mounting holes | 21 Receptacle, straight, with mounting holes

31 Plug, straight, without mounting holes | 41 Receptacle, straight, without mounting holes

SIZE

XXX 004 -128 | XXX 004 -128

Note: Maximum number of contacts is reduced when using hardware or mounting holes. See dimension chart on M-23.

CONTACTS

TYPE CONTACTS/TERMINATIONS:

- 11 Pin, straight, solder cup
- 14 Pin, straight, .500" pigtails (.018 dia)
- 15 Pin, straight, 1.000" pigtails (.018 dia)
- 16 Pin, straight, crimped wire

TYPE CONTACTS/TERMINATIONS:

- 21 Socket, straight, solder cup
- 24 Socket, straight, .500" pigtails (.018 dia)
- 25 Socket, straight, 1.000" pigtails (.018 dia)
- 26 Socket, straight, crimped wire

PLATING OPTIONS:

- 1 50 μ" Au contacts (crimp wire)
- 3 50 μ" Au contacts; 10 μ" Au terminations (solder cup, pigtail)
- 5 50 μ" Au contacts; Sn/Pb alloy terminations (pigtail)
- 7 50 μ" Au contacts; SAC305 terminations (pigtail)

PLATING OPTIONS:

- 1 50 μ" Au contacts (crimp wire)
- 3 50 μ" Au contacts; 10 μ" Au terminations (solder cup, pigtail)
- 5 50 μ" Au contacts; Sn/Pb alloy terminations (pigtail)
- 7 50 μ" Au contacts; SAC305 terminations (pigtail)

HARDWARE

STYLE OF HARDWARE:

- A00 None
- ABC Latch box, side mounted (centered)* See page M-27
- A50 Latch boxes (two end cavities). See page M-27**
- A52 Latch boxes (two end cavities). See page M-27**
- A54 Latch boxes (two end cavities). See page M-27**
- A56 Latch boxes (two end cavities). See page M-27**
- A64 One guide hole (centered)*
- A65 One guide hole (first cavity)
- A66 One guide hole (last cavity)
- A68 Two guide holes (first & last cavity)
- AHX One guide hole (cavity #2 - #9)

STYLE OF HARDWARE:

- A00 None
- ALC Latch spring, side mounted (centered)* See page M-27
- A51 Latch springs, (two end cavities). See page M-27**
- A53 Latch springs, (two end cavities). See page M-27**
- A55 Latch springs, (two end cavities). See page M-27**
- A57 Latch springs, (two end cavities). See page M-27**
- A61 One guide pin (centered)*
- A62 One guide pin (first cavity)
- A63 One guide pin (last cavity)
- A67 Two guide pins (first & last cavity)
- APX One guide pin (cavity #2 - #9)

POLARIZATION / WIRING:

- 00 None
- XX For wiring codes, see page MA-3 & MA-4

POLARIZATION / WIRING:

- 00 None
- XX For wiring codes, see page MA-3 & MA-4

* = To determine location, divide the total number of cavities (in one row) by two and round to the next whole number, if result is a fraction. See page M-28.
 ** = Not available with mounting holes.
 See MA strip guidelines, page M-28, for location examples & visual clarification.
 Connector part number must have even number of contacts.
 Consult factory for non-standard requirements.

= Option not RoHS compliant

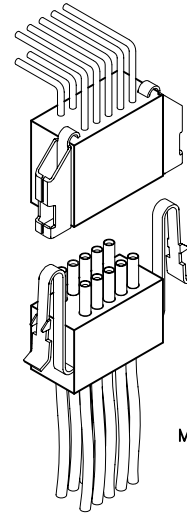

MA-241-010-261-A53WA

2 · ROW Strip Connectors Board to Cable

.050"

MA-2

4 thru 128 Contacts

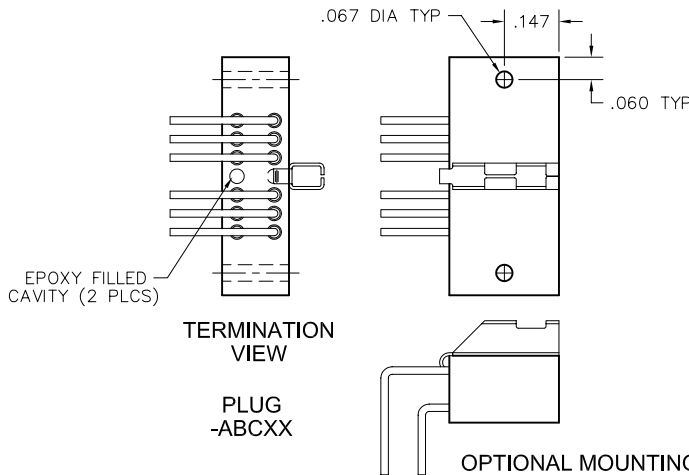
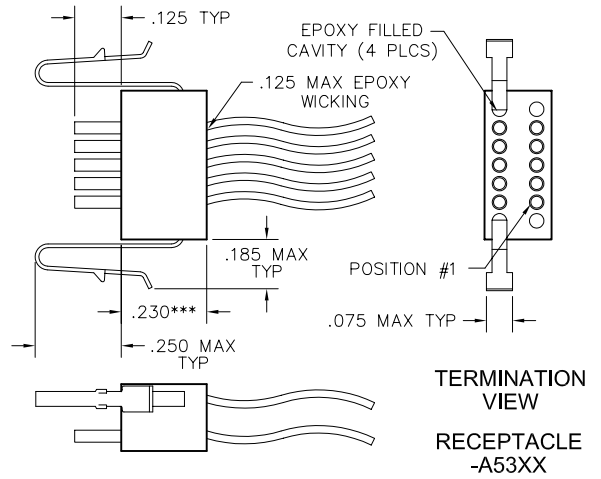
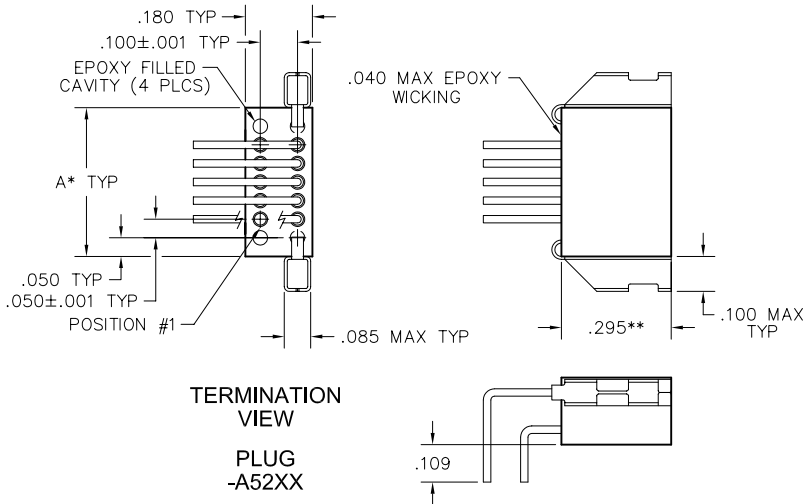

DIMENSIONS

To determine connector length (Dim "A"):	
Multiply the number of cavities in one row by .050"	. "
Add fixed end lengths (constant, .025" x 2)	0.05"
Add .085" for each mounting hole	. "
Total Length:	. "

Notes:

Length over 2" may require support to insure alignment

* = Maximum length is 3.420". Maximum number of contacts must be reduced to accommodate hardware and mounting holes.

** = For cable applications, .295" becomes .390"

*** = For solder cup or board mount applications, .230" becomes .135"

LEAD CONFIGURATION OPTIONS

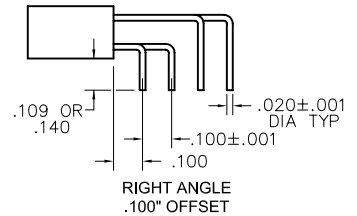
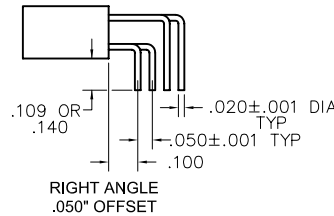
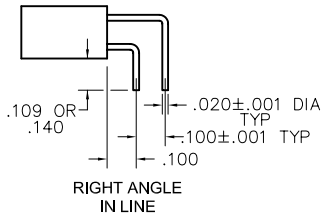
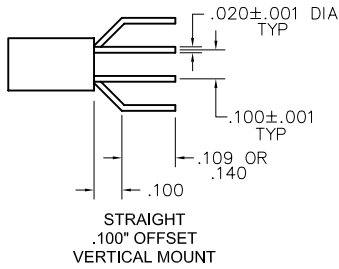

PLUG: MA-2F1-010-325-A5200
RECEPTACLE: MA-241-010-261-A53WA
 XX-XXX-XXX-XXX-XXXX

PLUG		RECEPTACLE	
SERIES			
MA .050" Microminiature Strip Connector		MA .050" Microminiature Strip Connector	
BODY			
2 2-Row	BODY STYLE: (Material: Polyphenylene sulfide)		2 2-Row
11 Plug, straight, with mounting holes	21 Receptacle, straight, with mounting holes		
31 Plug, straight, without mounting holes	41 Receptacle, straight, without mounting holes		
51 Plug, right angle, .050" offset, with mounting holes	61 Receptacle, right angle, .050" offset, with mounting holes		
71 Plug, right angle, .100" offset, with mounting holes	81 Receptacle, right angle, .100" offset, with mounting holes		
91 Plug, right angle, .050" offset, without mounting holes	A1 Receptacle, right angle, .050" offset, without mounting holes		
B1 Plug, right angle, .100" offset, without mounting holes	C1 Receptacle, right angle, .100" offset, without mounting holes		
D1 Plug, right angle, in line, with mounting holes	E1 Receptacle, right angle, in line, with mounting holes		
F1 Plug, right angle, in line, without mounting holes	G1 Receptacle, right angle, in line, without mounting holes		
H1 Plug, straight, .100" offset, without mounting holes	J1 Receptacle, straight, .100" offset, without mounting holes		
SIZE			
XXX 004- 128		XXX 004-128	
Note: Maximum number of contacts is reduced when using hardware or mounting holes. See dimension chart on M-25.			
CONTACTS			
TYPE CONTACTS/TERMINATIONS:		TYPE CONTACTS/TERMINATIONS:	
11 Pin, straight, solder cup	21 Socket, straight, solder cup		
12 Pin, straight, PCB leads, .109"	22 Socket, straight, PCB leads, .109"		
13 Pin, straight, PCB leads, .140"	23 Socket, straight, PCB leads, .140"		
14 Pin, straight, .500" pigtails (.018 dia)	24 Socket, straight, .500" pigtails (.018 dia)		
15 Pin, straight, 1.000" pigtails (.018 dia)	25 Socket, straight, 1.000" pigtails (.018 dia)		
16 Pin, straight, crimped wire	26 Socket, straight, crimped wire		
32 Pin, right angle, PCB leads, .109"	43 Socket, right angle, PCB leads, .109"		
33 Pin, right angle, PCB leads, .140"	44 Socket, right angle, PCB leads, .140"		
PLATING OPTIONS:		PLATING OPTIONS:	
1 50 μ" Au contacts (crimp wire)	1 50 μ" Au contacts (crimp wire)		
3 50 μ" Au contacts: 10 μ" Au terminations (solder cup, pigtail, PCB leads)	3 50 μ" Au contacts: 10 μ" Au terminations (solder cup, pigtail, PCB leads)		
5 50 μ" Au contacts; Sn/Pb alloy terminations (pigtail, PCB leads) <input checked="" type="checkbox"/>	5 50 μ" Au contacts; Sn/Pb alloy terminations (pigtail, PCB leads) <input checked="" type="checkbox"/>		
7 50 μ" Au contacts; SAC305 terminations (pigtail, PCB leads)	7 50 μ" Au contacts; SAC305 terminations (pigtail, PCB leads)		
HARDWARE			
STYLE OF HARDWARE:		STYLE OF HARDWARE:	
A00 None	A00 None		
ABC Latch box, side mounted (centered)* See page M-27	ALC Latch spring, side mounted (centered)* See page M-27		
A50 Latch boxes (two end cavities). See page M-27**	A51 Latch springs, (two end cavities). See page M-27**		
A52 Latch boxes (two end cavities). See page M-27**	A53 Latch springs, (two end cavities). See page M-27**		
A54 Latch boxes (two end cavities). See page M-27**	A55 Latch springs, (two end cavities). See page M-27**		
A56 Latch boxes (two end cavities). See page M-27**	A57 Latch springs, (two end cavities). See page M-27**		
A64 One guide hole (centered)*	A61 One guide pin (centered)*		
A65 One guide hole (first cavity)	A62 One guide pin (first cavity)		
A66 One guide hole (last cavity)	A63 One guide pin (last cavity)		
A68 Two guide holes (first & last cavity)	A67 Two guide pins (first & last cavity)		
AHX One guide hole (cavity #2 - #9)	APX One guide pin (cavity #2 - #9)		
POLARIZATION / WIRING:		POLARIZATION / WIRING	
00 None	00 None		
XX For wiring codes, see page MA-3 & MA-4	XX For wiring codes, see page MA-3 & MA-4		

* = To determine location, divide the total number of cavities (in one row) by two and round to the next whole number, if result is a fraction. See page M-28.
 ** = Not available with mounting holes.
 See MA strip guidelines, page M-28, for location examples & visual clarification.
 Connector part number must have even number of contacts.
 Consult factory for non-standard requirements.
 = Option not RoHS compliant

2 • ROW Strip Connectors with Latches

.050"

MA-2

4 thru 128 Contacts

PLUG LATCH BOX

EXAMPLE: MA-231-012-161-A50WN

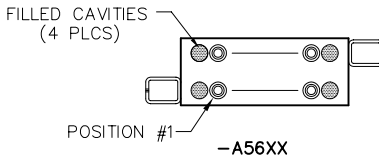
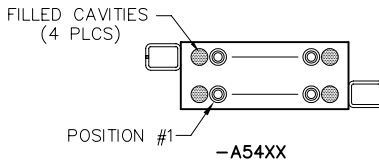
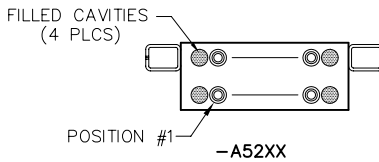
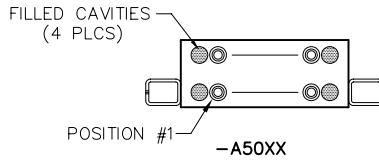

RECEPTACLE LATCH SPRING

EXAMPLE: MA-241-012-261-A51WN

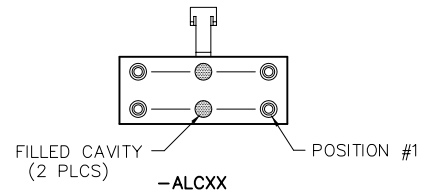
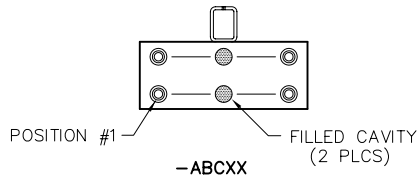
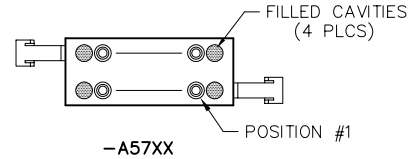
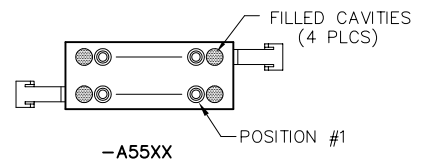
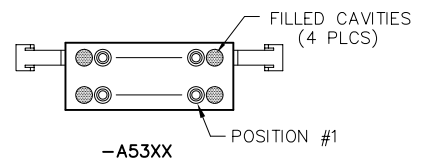
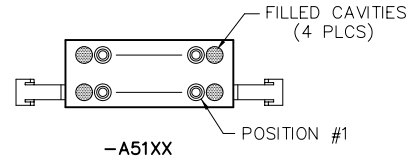

NOTE: ALL DRAWINGS VIEWED FROM MATING FACE

MA Strip Guidelines

For "A" designator in hardware portion of part number

1. Any cavity that has a contact is considered an electrical position (including dummy contact).
2. All hardware locations, holes and/or epoxy filled cavities are considered mechanical positions.
3. The cavity adjacent to a mechanical hole, in opposite row, will be an epoxy filled cavity (two row only).
4. Side mount latch will always be in row two of connector (two row only).
5. Connector must always have an even number of contacts for standard part number (two row only). Consult factory for non-standard requirements.
6. Omit holes on board layout for mechanical positions and renumber board layout accordingly, except connectors with mechanical position(s) in end cavity(ies).
See board layout examples, pages M-29 thru M-34.
7. These guidelines apply for all hardware options, including guide holes (mechanical locations).
8. Do not skip wire colors on stranded wire assemblies.
9. Spacers underneath the connector are recommended when R/A PCB mount connectors with mounting holes are used and the PCB had irregularities greater than .004" underneath the connector.

To determine centered hardware location number:

1. Divide the total number of cavities in one row by two (including hardware cavity).
2. Round to the next whole number if result is a fraction.
3. Guide hardware will be located in Row 1 and Latch hardware will be in Row 2.

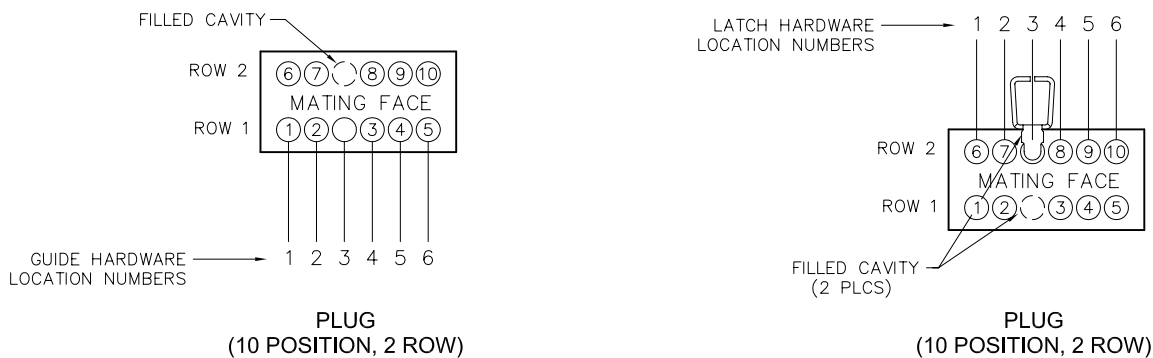

The example above shows 12 cavities with 10 live contacts.
(10 electrical positions & 2 mechanical positions)

To determine the hardware location number:
 $6 \text{ cavities (in one row)} \div 2 = 3$
 Hardware would be placed in location #3.

Board mount connectors, right angle offset (.100") with mounting holes (12 electrical positions)

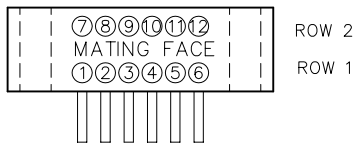
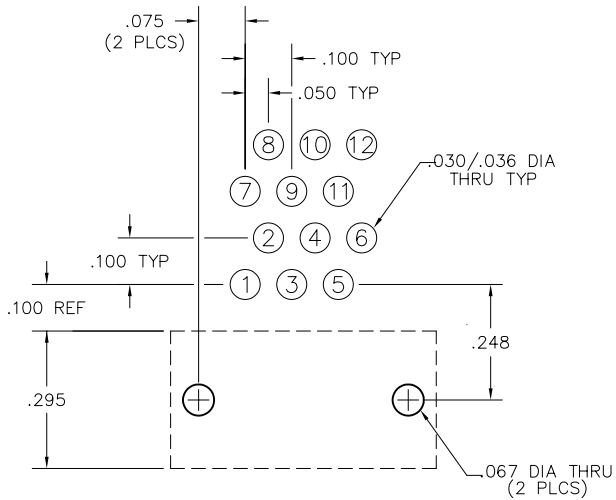

PLUG
MA-271-012-325-A0000

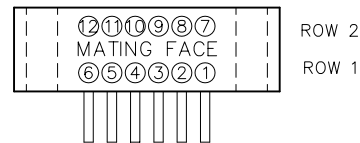
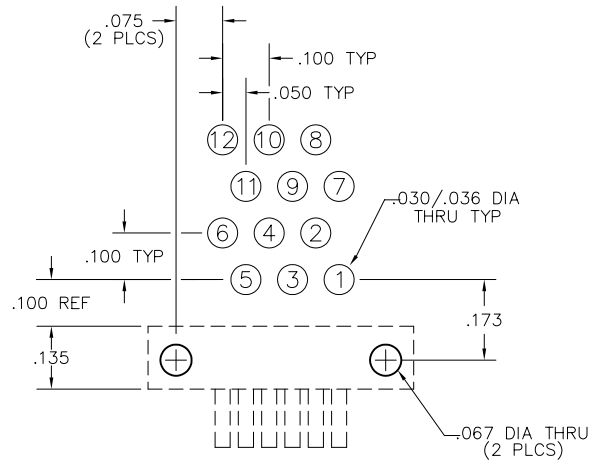

RECEPTACLE
MA-281-012-435-A0000

Crimped wire connectors, straight without mounting holes (12 electrical positions)



PLUG
MA-231-012-161-A00WA



RECEPTACLE
MA-241-012-261-A00WA

WIRE CONNECT CHART

1 — BLK	7 — BLU
2 — BRN	8 — VIO
3 — RED	9 — GRY
4 — ORN	10 — WHT
5 — YEL	11 — WHT/BLK
6 — GRN	12 — WHT/BRN

Board mount connectors, right angle offset (.100") with mounting holes. Side mount latch, centered.

Note: Side mount latch will always be in row #2 of connector. Not recommended on row #1 for board mount applications.

(10 electrical positions, 2 mechanical positions)

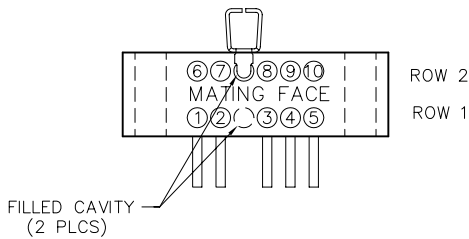
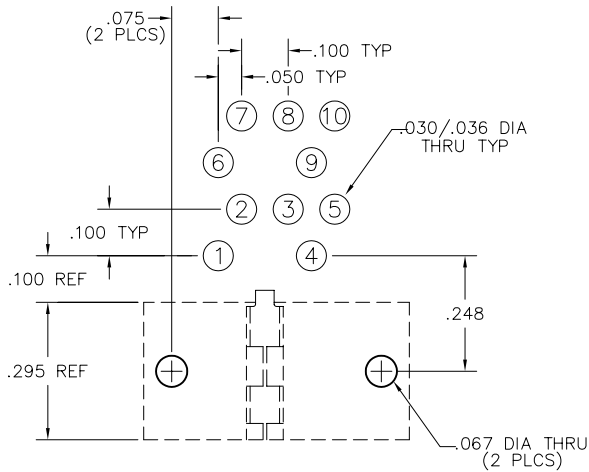

PLUG
MA-271-010-325-ABC00

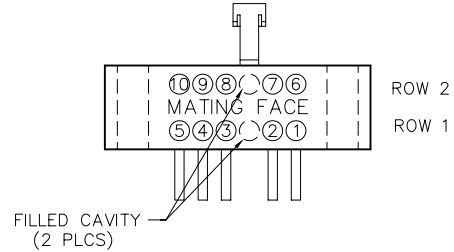
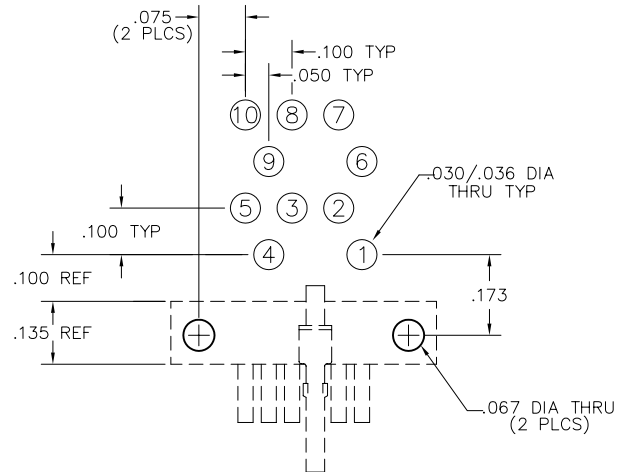

RECEPTACLE
MA-281-010-435-ALC00

Crimped wire connectors, straight with mounting holes. Side mount latch, centered.

Note: Side mount latch will always be in row #2 of connector.

(10 electrical positions, 2 mechanical positions)

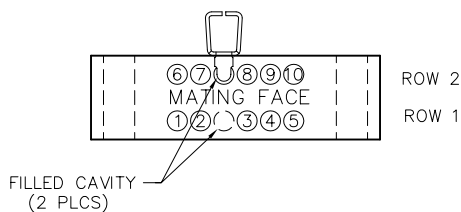

PLUG
MA-211-010-161-ABCWA

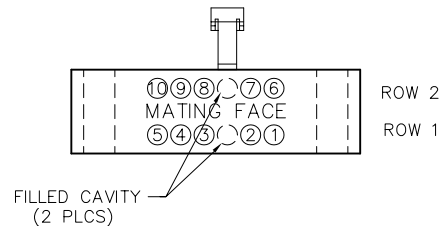

RECEPTACLE
MA-221-010-261-ALCWA

WIRE CONNECT CHART

1 — BLK	6 — GRN
2 — BRN	7 — BLU
3 — RED	8 — VIO
4 — ORN	9 — GRY
5 — YEL	10 — WHT



Board mount connectors, right angle offset (.100") without mounting holes End mount latches, 2 end cavities*

(12 electrical positions, 4 mechanical positions)

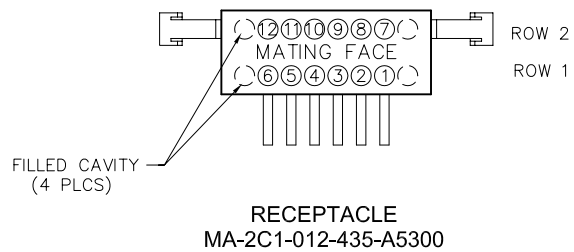
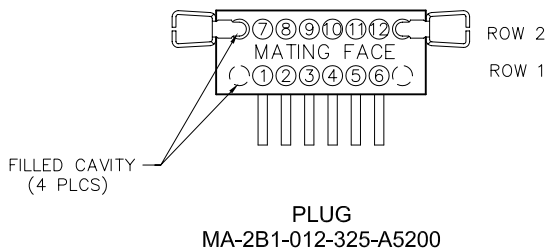
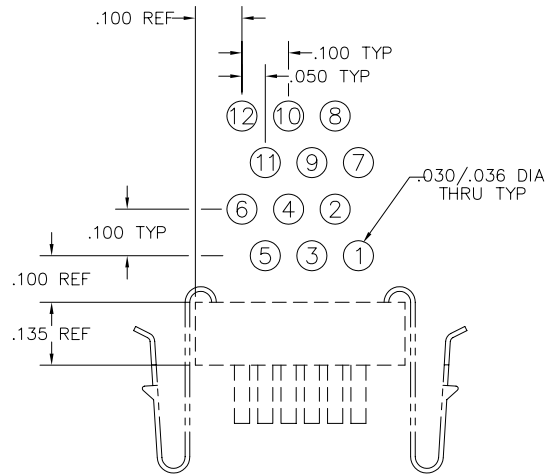
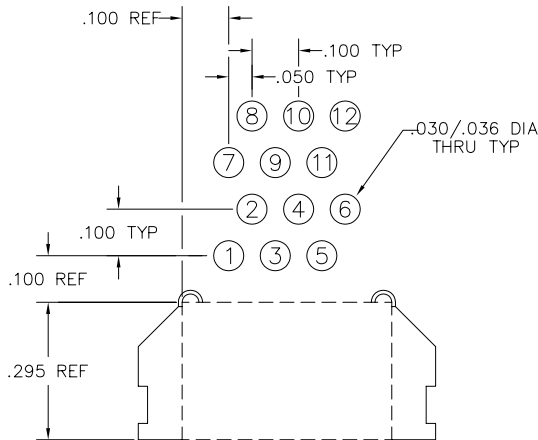

THIS IS THE EXCEPTION AS NOTED IN "MA STRIP GUIDELINES", PAGE M-28, NOTE 6.

Crimped wire connectors, straight without mounting holes End mount latches, 2 end cavities

(6 electrical positions, 4 mechanical positions)

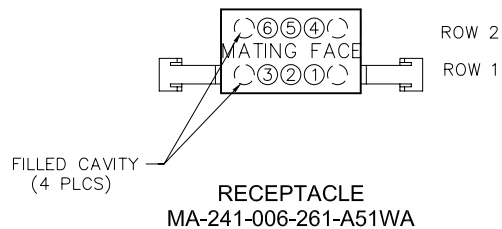
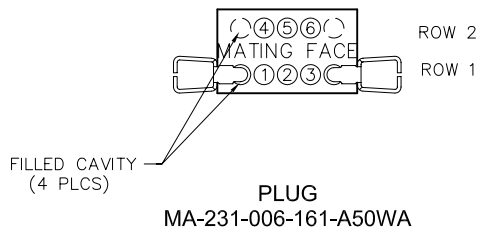

WIRE CONNECT CHART

- 1 — BLK
- 2 — BRN
- 3 — RED
- 4 — ORN
- 5 — YEL
- 6 — GRN

Board mount connectors, right angle inline (.100") with mounting holes Side mount latch, centered

Note: Side mount latch will always be in row #2 of connector. Not recommended on row #1 for board mount applications.

(10 electrical positions, 2 mechanical positions)

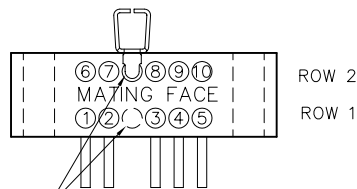
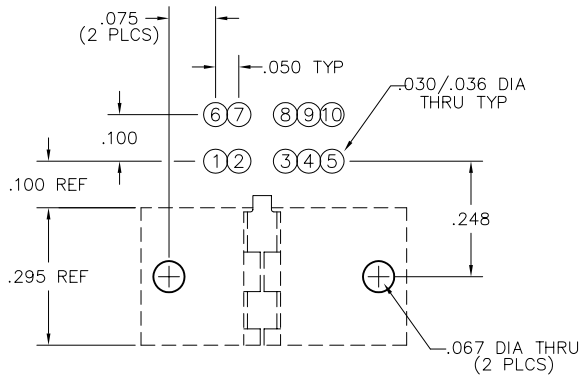

PLUG
MA-2D1-010-325-ABC00

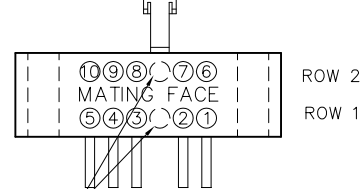
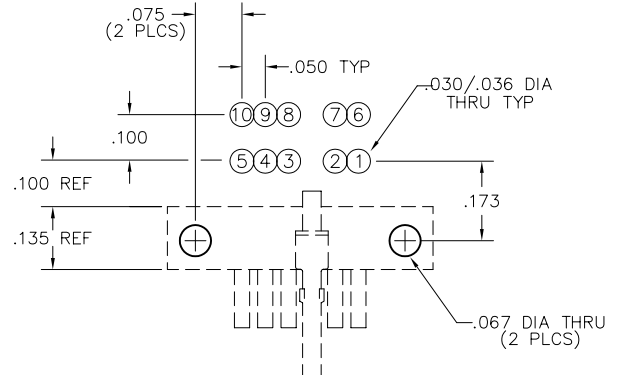

RECEPTACLE
MA-2E1-010-435-ALC00

Crimped wire connectors, straight without mounting holes Side mount latch, centered

(10 electrical positions, 2 mechanical positions)

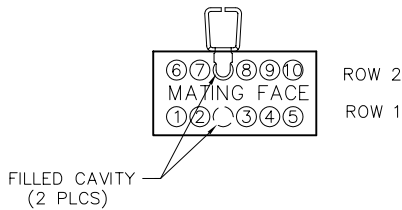

PLUG
MA-231-010-161-ABCWA

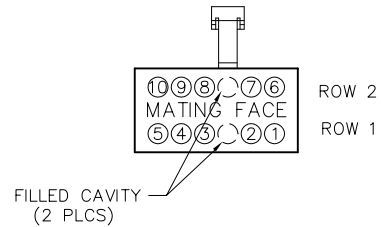

RECEPTACLE
MA-241-010-261-ALCWA

WIRE CONNECT CHART

1 — BLK	6 — GRN
2 — BRN	7 — BLU
3 — RED	8 — VIO
4 — ORN	9 — GRY
5 — YEL	10 — WHT



Board mount connectors, straight offset (.100") without mounting holes

Two guide holes/pins, first & last cavities

(8 electrical positions, 4 mechanical positions)

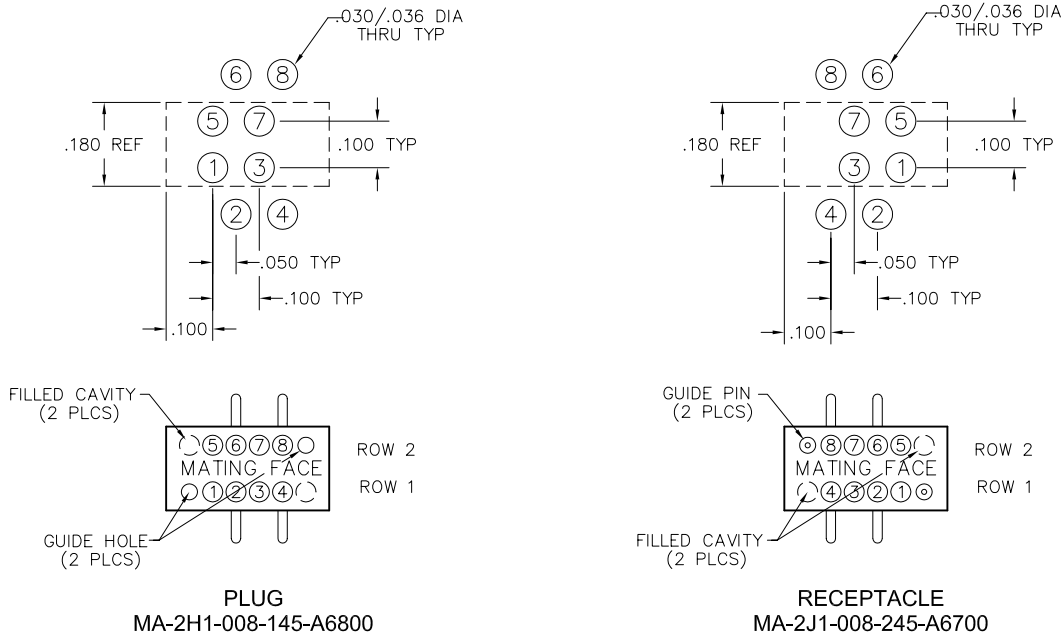

Crimped wire connectors, straight without mounting holes

Two guide holes/pins, first & last cavities

(8 electrical positions, 4 mechanical positions)



WIRE CONNECT CHART

1	—	BLK	5	—	YEL
2	—	BRN	6	—	GRN
3	—	RED	7	—	BLU
4	—	ORN	8	—	VIO

Board mount connectors, right angle offset (.050") with mounting holes

Guide hole/pin, last cavity

(10 electrical positions, 2 mechanical positions)

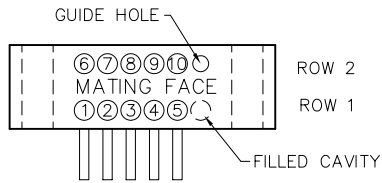
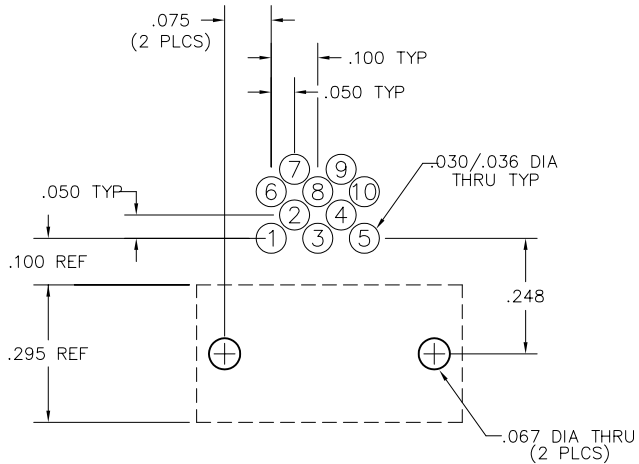

PLUG
MA-251-010-325-A6600

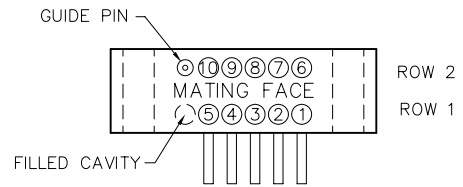
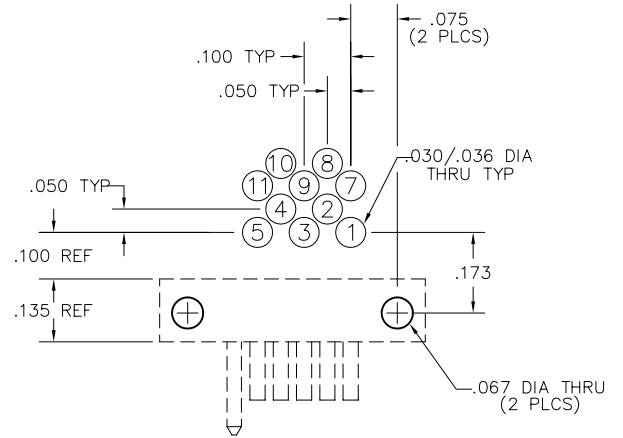

RECEPTACLE
MA-261-010-435-A6300

Crimped wire connectors, straight with mounting holes

Guide hole/pin, last cavity

(10 electrical positions, 2 mechanical positions)

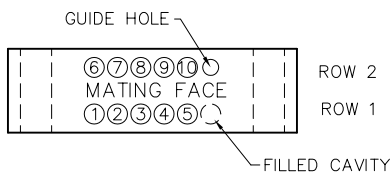

PLUG
MA-211-010-161-A66WA

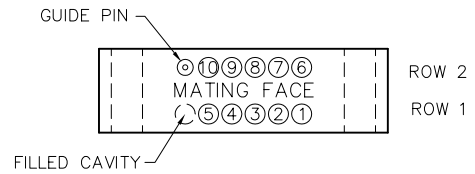

RECEPTACLE
MA-221-010-261-A63WA

WIRE CONNECT CHART

1 — BLK	6 — GRN
2 — BRN	7 — BLU
3 — RED	8 — VIO
4 — ORN	9 — GRY
5 — YEL	10 — WHT



Cable to Cable

.050"

9 thru 100 Contacts

Rugged Metal

MM

Rugged Plastic

MN

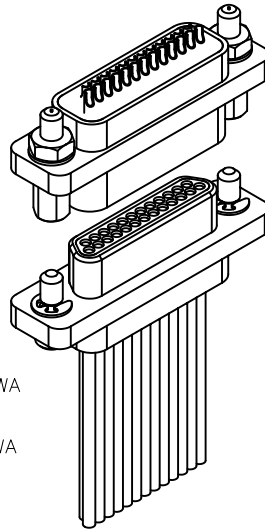

MM-223-025-2A3-2200
(METAL)

MN-221-025-2A3-2200
(PLASTIC)

MM-212-025-161-41WA
(METAL)

MN-211-025-161-41WA
(PLASTIC)

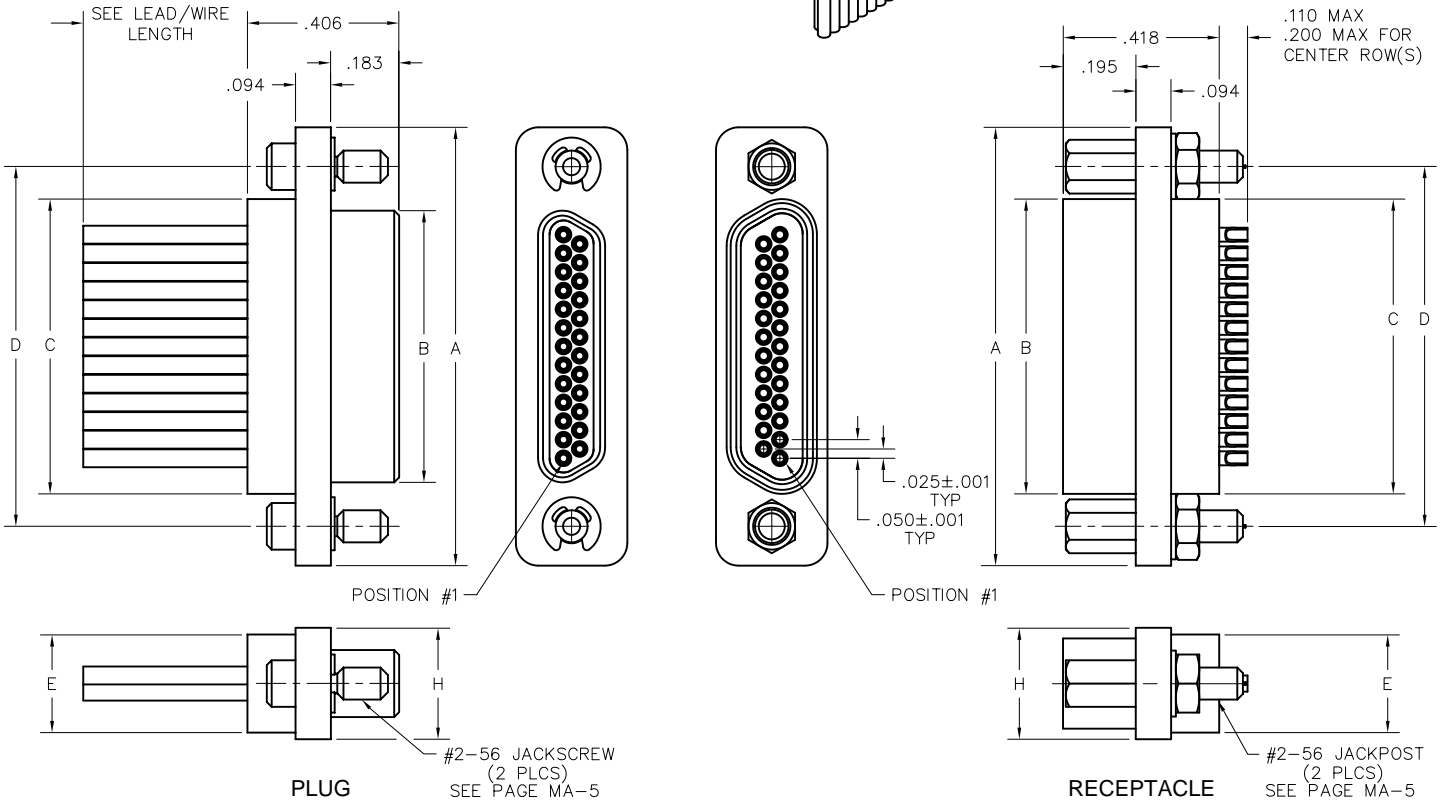

SIZE	CONTACT ROWS	DIMENSIONS							H	HARDWARE
		A	B		C	D	E			
			PLUG MAX	RCPT MAX				POTTING WELL MAX		
9	2	.775	.334	.400	.390	.565	.270	.298	#2-56 UNC THD (.092 DIA THRU)	
15		.925	.484	.550	.540	.715				
21		1.075	.634	.700	.690	.865				
25		1.175	.734	.800	.790	.965				
31		1.325	.884	.950	.940	1.115				
37		1.475	1.034	1.100	1.090	1.265				
51**		1.825	1.384	1.450	1.440	1.615				
51	3	1.425	.984	1.050	1.040	1.215	.310	.341		
69		1.725	1.284	1.350	1.340	1.515				
100	4	2.160	1.384	1.508	1.432	1.800	.360	.384	#4-40 UNC THD (.147 DIA THRU)	

* = 69 POSITION CONNECTORS ARE AVAILABLE IN METAL ONLY.

** = 2 ROW, 51 POSITION CONNECTORS ARE AVAILABLE IN METAL ONLY,
(NON MIL-SPEC INTERFACE).

PLUG: MM-212-031-161-41WA
RECEPTACLE: MM-222-031-2G3-4500
PLUG: MN-211-031-161-41WA
RECEPTACLE: MN-221-031-2G3-4500
 XX-XXX-XXX-XXX-XXXX-XXX

PLUG		RECEPTACLE	
SERIES			
MM .050" Rugged Metal I/O Connector	MM .050" Rugged Metal I/O Connector	MN .050" Rugged Plastic I/O Connector	MN .050" Rugged Plastic I/O Connector
(MM & MN mate with MK, ML, MM, MN receptacles)		(MM & MN mate with MK, ML, MM, MN plugs)	
BODY			
2 2-Row (Sizes 9 thru 51****)	2 2-Row (Sizes 9 thru 51****)	3 3-Row (Size 51 & 69****)	3 3-Row (Size 51 & 69****)
3 3-Row (Size 51 & 69****)	4 4-Row (Size 100)	4 4-Row (Size 100)	
BODY STYLE:		BODY STYLE:	
1 Plug, straight, with ears		2 Receptacle, straight, with ears	
BODY MATERIAL:		BODY MATERIAL:	
1 Polyphenylene Sulfide (MN only)	1 Polyphenylene Sulfide (MN only)	2 Polyphenylene Sulfide with electroless nickel shell	2 Polyphenylene Sulfide with electroless nickel shell
2 Polyphenylene Sulfide with electroless nickel shell	3 Polyphenylene Sulfide with electroless nickel shell	3 Polyphenylene Sulfide with electroless nickel shell	3 Polyphenylene Sulfide with electroless nickel shell
3 Polyphenylene Sulfide with electroless nickel shell	4 Polyphenylene Sulfide with hard anodized black shell	4 Polyphenylene Sulfide with hard anodized black shell	4 Polyphenylene Sulfide with hard anodized black shell
4 Polyphenylene Sulfide with hard anodized black shell	5 Polyphenylene Sulfide with stainless steel shell	5 Polyphenylene Sulfide with stainless steel shell	5 Polyphenylene Sulfide with stainless steel shell
5 Polyphenylene Sulfide with stainless steel shell			
SIZE			
XXX 009, 015, 021, 025, 031, 037, 051****, 069****, 100		XXX 009, 015, 021, 025, 031, 037, 051****, 069****, 100	
CONTACTS			
TYPE CONTACTS/TERMINATIONS:		TYPE CONTACTS/TERMINATIONS:	
11 Pin, straight, 26 awg solder cup	21 Socket, straight, 26 awg solder cup	2A Socket, straight, 24 awg solder cup	2A Socket, straight, 24 awg solder cup
1A Pin, straight, 24 awg solder cup	2D Socket, straight, .109" Lead Length (.018 dia) SEE NOTE 1	2E Socket, straight, .125" Lead Length (.018 dia)	2E Socket, straight, .125" Lead Length (.018 dia)
1D Pin, straight, .109" Lead Length (.018 dia) SEE NOTE 1	2F Socket, straight, .140" Lead Length (.018 dia) SEE NOTE 1	2F Socket, straight, .140" Lead Length (.018 dia)	2F Socket, straight, .140" Lead Length (.018 dia)
1E Pin, straight, .125" Lead Length (.018 dia) SEE NOTE 1	2G Socket, straight, .156" Lead Length (.018 dia) SEE NOTE 1	2G Socket, straight, .156" Lead Length (.018 dia)	2G Socket, straight, .156" Lead Length (.018 dia)
1F Pin, straight, .140" Lead Length (.018 dia) SEE NOTE 1	2H Socket, straight, .172" Lead Length (.018 dia) SEE NOTE 1	2H Socket, straight, .172" Lead Length (.018 dia)	2H Socket, straight, .172" Lead Length (.018 dia)
1G Pin, straight, .156" Lead Length (.018 dia) SEE NOTE 1	2J Socket, straight, .187" Lead Length (.018 dia) SEE NOTE 1	2J Socket, straight, .187" Lead Length (.018 dia)	2J Socket, straight, .187" Lead Length (.018 dia)
1H Pin, straight, .172" Lead Length (.018 dia) SEE NOTE 1	2K Socket, straight, .375" Lead Length (.018 dia) SEE NOTE 1	2K Socket, straight, .375" Lead Length (.018 dia)	2K Socket, straight, .375" Lead Length (.018 dia)
1J Pin, straight, .187" Lead Length (.018 dia) SEE NOTE 1	2L Socket, straight, .500" Lead Length (.018 dia) SEE NOTE 1	2L Socket, straight, .500" Lead Length (.018 dia)	2L Socket, straight, .500" Lead Length (.018 dia)
1K Pin, straight, .250" Lead Length (.018 dia) SEE NOTE 1	2M Socket, straight, 1.000" Lead Length (.018 dia) SEE NOTE 1	2M Socket, straight, 1.000" Lead Length (.018 dia)	2M Socket, straight, 1.000" Lead Length (.018 dia)
1L Pin, straight, .375" Lead Length (.018 dia) SEE NOTE 1	24 Socket, straight, .500" Lead Length (.018 dia) SEE NOTE 1	24 Socket, straight, .500" Lead Length (.018 dia)	24 Socket, straight, .500" Lead Length (.018 dia)
1M Pin, straight, .500" Lead Length (.018 dia) SEE NOTE 1	25 Socket, straight, 1.000" Lead Length (.018 dia) SEE NOTE 1	25 Socket, straight, 1.000" Lead Length (.018 dia)	25 Socket, straight, 1.000" Lead Length (.018 dia)
1N Pin, straight, 1.000" Lead Length (.018 dia) SEE NOTE 1	26 Socket, straight, crimped wire	26 Socket, straight, crimped wire	26 Socket, straight, crimped wire
16 Pin, straight, crimped wire			
PLATING OPTIONS:		PLATING OPTIONS:	
1 50 μ" Au contacts (crimp wire)	1 50 μ" Au contacts (crimp wire)	3 50 μ" Au contacts (solder cup, pigtail)	3 50 μ" Au contacts (solder cup, pigtail)
3 50 μ" Au contacts (solder cup, pigtail)	5 50 μ" Au contacts; Sn/Pb alloy terminations <input checked="" type="checkbox"/>	5 50 μ" Au contacts; Sn/Pb alloy terminations <input checked="" type="checkbox"/>	5 50 μ" Au contacts; Sn/Pb alloy terminations <input checked="" type="checkbox"/>
5 50 μ" Au contacts; Sn/Pb alloy terminations <input checked="" type="checkbox"/>	7 50 μ" Au contacts; SAC305 terminations	7 50 μ" Au contacts; SAC305 terminations	7 50 μ" Au contacts; SAC305 terminations
7 50 μ" Au contacts; SAC305 terminations			
HARDWARE			
STYLE OF HARDWARE:		STYLE OF HARDWARE:	
00 None	00 None	22 Two fixed jacknut assemblies (62*)	22 Two fixed jacknut assemblies (62*)
22 Two fixed jacknut assemblies (62*)	41 Two turning jackscrews, allen head, retaining ring (81*)	41 Two turning jackscrews, allen head, retaining ring (81*)	41 Two turning jackscrews, allen head, retaining ring (81*)
41 Two turning jackscrews, allen head, retaining ring (81*)	42 Two long turning jackscrews, allen head, retaining ring (82*)	42 Two long turning jackscrews, allen head, retaining ring (82*)	42 Two long turning jackscrews, allen head, retaining ring (82*)
42 Two long turning jackscrews, allen head, retaining ring (82*)	43 Two turning jackscrews, slot head, retaining ring (83*)	43 Two turning jackscrews, slot head, retaining ring (83*)	43 Two turning jackscrews, slot head, retaining ring (83*)
43 Two turning jackscrews, slot head, retaining ring (83*)	44 Two long turning jackscrews, slot head, retaining ring (84*)	44 Two long turning jackscrews, slot head, retaining ring (84*)	44 Two long turning jackscrews, slot head, retaining ring (84*)
44 Two long turning jackscrews, slot head, retaining ring (84*)	45 Two turning jackscrews, allen head, captivated** (85*)	45 Two turning jackscrews, allen head, captivated** (85*)	45 Two turning jackscrews, allen head, captivated** (85*)
45 Two turning jackscrews, allen head, captivated** (85*)	99 Keying hardware, see options below. (Body material 2, 3 and 4 only)	99 Keying hardware, see options below. (Body material 2, 3 and 4 only)	99 Keying hardware, see options below. (Body material 2, 3 and 4 only)
99 Keying hardware, see options below. (Body material 2, 3 and 4 only)			
POLARIZATION / WIRING		POLARIZATION / WIRING	
00 None	00 None	XX For wiring codes, see page MA-3 & MA-4	XX For wiring codes, see page MA-3 & MA-4
XX For wiring codes, see page MA-3 & MA-4			
OPTIONS			
KSXX Two turning jackscrews. See page MA-6 for keying options (KJ*)	KSXX Two turning jackscrews and interfacial sealing gasket. See page MA-6 for keying options (KJ*)	KPXX Two fixed jacknuts. See page MA-6 for keying options (KN*)	KPXX Two fixed jacknuts and interfacial sealing gasket. See page MA-6 for keying options (KN*)
KPXX Two fixed jacknuts. See page MA-6 for keying options (KN*)	900 Interfacial sealing gasket	900 Interfacial sealing gasket	900 Interfacial sealing gasket
900 Interfacial sealing gasket			

* = Use numbers or letters in parenthesis when ordering size 100.

** = Captive hardware is factory installed and non-removable.

*** = 69 position connectors are available in metal only.

**** = 2 row, 51 position connectors are available in metal only (non Mil-Spec interface).

= Option not RoHS compliant

NOTE 1 = The leads on these contacts are soft copper suitable for forming.



Cable to Cable Grounding Fingers

.050"

9 thru 100 Contacts

Rugged Metal

MM

MM-212-031-161-22WQ
(METAL)

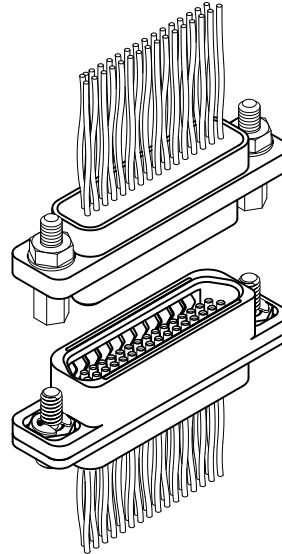

MM-2D2-031-261-41WA
(METAL)

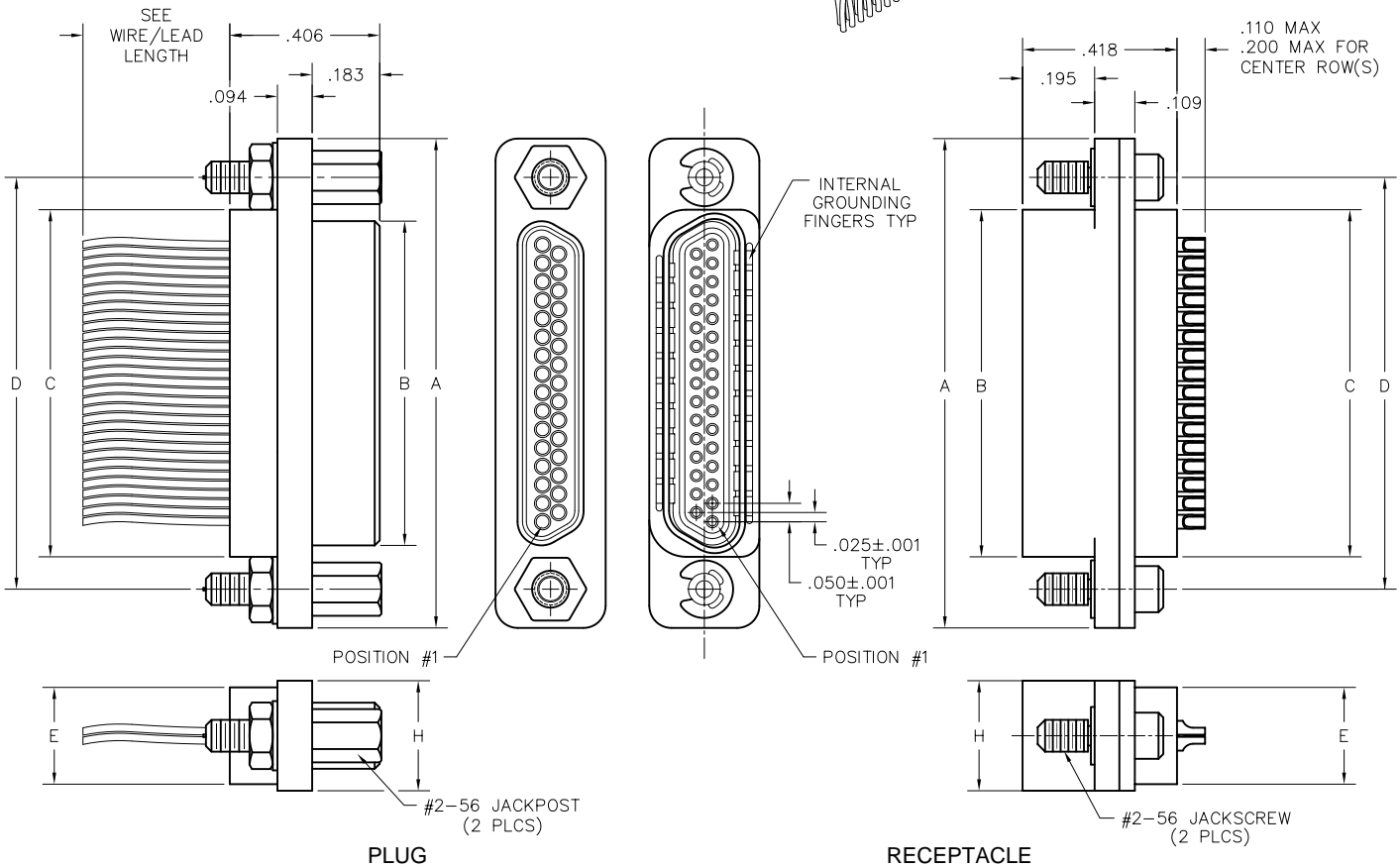

SIZE	CONTACT ROWS	DIMENSIONS							H	HARDWARE
		A	B		C	D	E			
			PLUG MAX	RCPT MAX				POTTING WELL MAX		
9	2	.775	.334	.400	.390	.565	.270	.298	#2-56 UNC THD (.092 DIA THRU)	
15		.925	.484	.550	.540	.715				
21		1.075	.634	.700	.690	.865				
25		1.175	.734	.800	.790	.965				
31		1.325	.884	.950	.940	1.115				
37	3	1.475	1.034	1.100	1.090	1.265	.310	.341	#4-40 UNC THD (.147 DIA THRU)	
51		1.425	.984	1.050	1.040	1.215				
69		1.725	1.284	1.350	1.340	1.515				
100	4	2.160	1.384	1.508	1.432	1.800	.360	.384	#4-40 UNC THD (.147 DIA THRU)	



PLUG: MM-212-031-161-22WQ
RECEPTACLE: MM-2D2-031-261-41WA
 XX-XXX-XXX-XXX-XXXX-XXX

PLUG		RECEPTACLE	
SERIES			
MM .050" Rugged Metal I/O Connector (MM mates with MK, ML, MM, MN receptacles)		MM .050" Rugged Metal I/O Connector (MM mates with MK, ML, MM, MN plugs)	
BODY			
2 2-Row (Sizes 9 thru 37)	2 2-Row (Sizes 9 thru 37)	3 3-Row (Size 51 & 69)	3 3-Row (Size 51 & 69)
3 3-Row (Size 51 & 69)	4 4-Row (Size 100)	4 4-Row (Size 100)	
BODY STYLE:		BODY STYLE:	
1 Plug, straight, with ears		D Receptacle, straight, with grounding fingers	
BODY MATERIAL:		BODY MATERIAL:	
2 Polyphenylene Sulfide with electroless nickel shell		2 Polyphenylene Sulfide with electroless nickel shell	
3 Polyphenylene Sulfide with electrodeposited cadmium shell ☒		3 Polyphenylene Sulfide with electrodeposited cadmium shell ☒	
6 Polyphenylene Sulfide with gold plated shell		6 Polyphenylene Sulfide with gold plated shell	
SIZE			
XXX 009, 015, 021, 025, 031, 037, 051, 069, 100		XXX 009, 015, 021, 025, 031, 037, 051, 069, 100	
CONTACTS			
TYPE CONTACTS/TERMINATIONS:		TYPE CONTACTS/TERMINATIONS:	
11 Pin, straight, solder cup	21 Socket, straight, solder cup	2A Socket, straight, 24 awg solder cup	
1A Pin, straight, 24 awg solder cup	2D Socket, straight, .109" Lead Length (.018 dia) SEE NOTE 1	2E Socket, straight, .125" Lead Length (.018 dia)	
1D Pin, straight, .109" Lead Length (.018 dia) SEE NOTE 1	2F Socket, straight, .140" Lead Length (.018 dia)	2G Socket, straight, .156" Lead Length (.018 dia)	
1E Pin, straight, .125" Lead Length (.018 dia) SEE NOTE 1	2H Socket, straight, .172" Lead Length (.018 dia)	2J Socket, straight, .187" Lead Length (.018 dia)	
1F Pin, straight, .140" Lead Length (.018 dia) SEE NOTE 1	2K Socket, straight, .375" Lead Length (.018 dia)	2L Socket, straight, .500" Lead Length (.018 dia)	
12 Pin, straight, .150" Lead Length (.018 dia) SEE NOTE 1	2M Socket, straight, 1.000" Lead Length (.018 dia)	24 Socket, straight, .500" pigtailed (.018 dia) SEE NOTE 1	
1G Pin, straight, .156" Lead Length (.018 dia) SEE NOTE 1	25 Socket, straight, 1.000" pigtailed (.018 dia) SEE NOTE 1	26 Socket, straight, crimped wire	
1H Pin, straight, .172" Lead Length (.018 dia) SEE NOTE 1			
1J Pin, straight, .187" Lead Length (.018 dia) SEE NOTE 1			
13 Pin, straight, .250" Lead Length (.018 dia) SEE NOTE 1			
1K Pin, straight, .375" Lead Length (.018 dia) SEE NOTE 1			
14 Pin, straight, .500" pigtailed (.018 dia) SEE NOTE 1			
15 Pin, straight, 1.000" pigtailed (.018 dia) SEE NOTE 1			
16 Pin, straight, crimped wire			
PLATING OPTIONS:		PLATING OPTIONS:	
1 50 μ" Au contacts (crimp wire)	1 50 μ" Au contacts (crimp wire)	3 50 u" Au contacts (solder cup, pigtail)	
3 50 μ" Au contacts (solder cup, pigtail)	5 50 u" Au contacts; Sn/Pb alloy terminations (pigtail) ☒	5 50 u" Au contacts; Sn/Pb alloy terminations (pigtail) ☒	
5 50 μ" Au contacts; Sn/Pb alloy terminations (pigtail) ☒	7 50 μ" Au contacts; SAC305 terminations (pigtail)	7 50 μ" Au contacts; SAC305 terminations (pigtail)	
7 50 μ" Au contacts; SAC305 terminations (pigtail)			
HARDWARE			
STYLE OF HARDWARE:		STYLE OF HARDWARE:	
00 None	22 Two fixed jacknut assemblies (62*)	00 None	22 Two fixed captive jacknut assemblies** (62*)
22 Two fixed jacknut assemblies (62*)	41 Two turning jackscrews, allen head, retaining ring (81*)	41 Two turning jackscrews, allen head, retaining ring (81*)	
41 Two turning jackscrews, allen head, retaining ring (81*)	42 Two long turning jackscrews, allen head, retaining ring (82*)	42 Two long turning jackscrews, allen head, retaining ring (82*)	
42 Two long turning jackscrews, allen head, retaining ring (82*)	43 Two turning jackscrews, slot head, retaining ring (83*)	43 Two turning jackscrews, slot head, retaining ring (83*)	
43 Two turning jackscrews, slot head, retaining ring (83*)	44 Two long turning jackscrews, slot head, retaining ring (84*)	44 Two long turning jackscrews, slot head, retaining ring (84*)	
44 Two long turning jackscrews, slot head, retaining ring (84*)	45 Two turning jackscrews, allen head, captivated** (85*)	45 Two turning jackscrews, allen head, captivated** (85*)	
45 Two turning jackscrews, allen head, captivated** (85*)	99 Keying hardware, see options below. (Body material 2 and 3 only)	99 Keying hardware, see options below. (Body material 2 and 3 only)	
99 Keying hardware, see options below. (Body material 2 and 3 only)			
POLARIZATION / WIRING:		POLARIZATION / WIRING:	
00 None	XX For wiring codes, see page MA-3 & MA-4	00 None	XX For wiring codes, see page MA-3 & MA-4
XX For wiring codes, see page MA-3 & MA-4			
OPTIONS			
KSXX Two turning jackscrews. See page MA-6 for keying options (KJ*)		KSXX Two turning jackscrews and interfacial sealing gasket. See page MA-6 for keying options (KJ*)	
KPXX Two fixed jacknuts. See page MA-6 for keying options (KN*)		KPXX Two fixed jacknuts and interfacial sealing gasket. See page MA-6 for keying options (KN*)	
		900 Interfacial sealing gasket	

* = Use numbers or letters in parenthesis when ordering size 100. NOTE 1 = The leads on these contacts are soft copper suitable for forming.
 ** = Captive hardware is factory installed and non-removable.
 ☒ = Option not RoHS compliant



Rugged Metal I/O (Integral Shield Termination)

.050"

9 thru 100 Contacts

MM

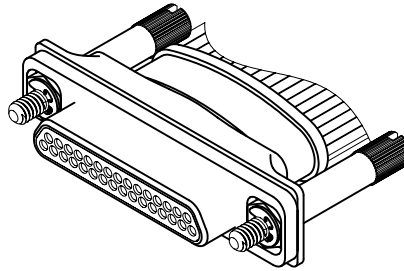

MM-2P2-031-161-44WA
(PLUG)

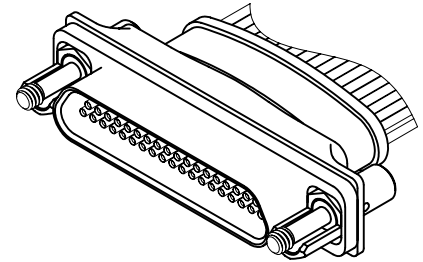

MM-2Q2-031-261-99WA-KS11
(RECEPTACLE)

MATING MATRIX	
CONNECTOR	MATES WITH
MM-2P...	MK, ML, MM, MN receptacles
MM-2Q...	MK, ML, MM, MN plugs

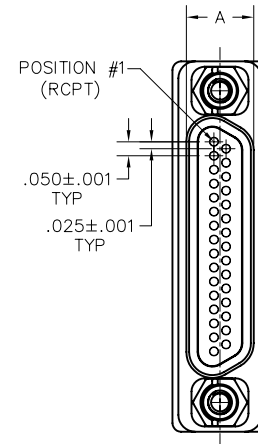
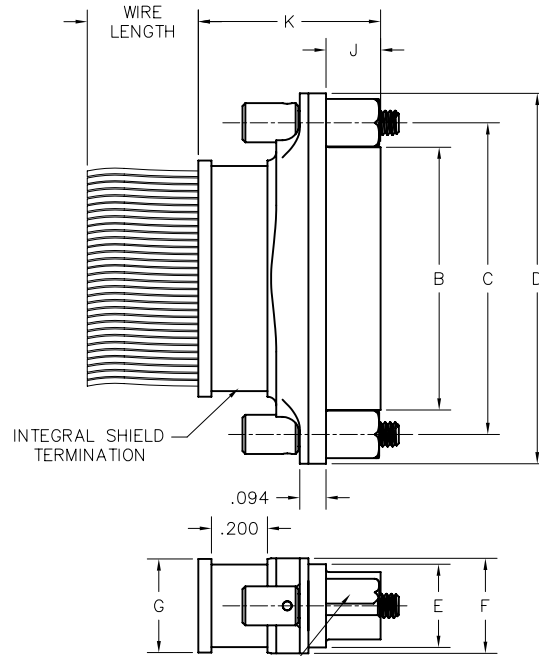
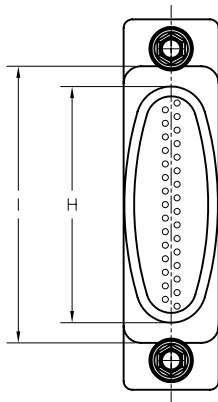

#2-56 KEYED JACKSCREW
(2 PLCS)

DIMENSIONS																	
SIZE	CONTACT ROWS	A		B		C	HARDWARE	D	E	F	G	H	I	J		K	
		PLUG MAX	RCPT MAX	PLUG MAX	RCPT MAX									PLUG	RCPT	PLUG	RCPT
9	2	.185	.251	.334	.400	.565	#2-56 UNC THD (.092 DIA THRU)	.775	.298	.340	.290	.290	.440	.183	.195	.640	.652
15				.484	.550	.715		.925				.445	.590				
21				.634	.700	.865		1.075				.595	.740				
25				.734	.800	.965		1.175				.695	.840				
31				.884	.950	1.115		1.325				.845	.990				
37				1.034	1.100	1.265		1.475				.995	1.140				
51	3	.228	.294	.984	1.050	1.215	#4-40 UNC THD (.147 DIA THRU)	1.425	.341	.380	.367	.945	1.090	.183	.195	.640	.652
51				1.384	1.450	1.615		1.825				1.345	1.490				
69				1.284	1.350	1.515		1.725				1.245	1.390				
100	4	.271	.394	1.384	1.508	1.800	#4-40 UNC THD (.147 DIA THRU)	2.160	.381	.430	.417	1.457	1.522				



PLUG: MM-2P2-031-161-44WA
RECEPTACLE: MM-2Q2-031-261-99WA-KS11
 XX-XXX-XXX-XXX-XXXX
 SERIES | SIZE | HARDWARE & WIRING
 BODY | CONTACTS

PLUG

RECEPTACLE

SERIES

MM .050" Rugged Metal I/O Connector

SERIES

MM .050" Rugged Metal I/O Connector

BODY

- 2 2-Row (Sizes 9 thru 37, 51)***
- 3 3-Row (Sizes 51 thru 69)
- 4 4-Row (Size 100)

BODY

- 2 2-Row (Sizes 9 thru 37, 51)***
- 3 3-Row (Sizes 51 thru 69)
- 4 4-Row (Size 100)

BODY STYLE:

P Plug, straight, with ears and integral shield termination

BODY STYLE:

Q Receptacle, straight, with ears and integral shield termination

BODY MATERIAL:

- 2 Polyphenylene Sulfide with electroless nickel shell
- 3 Polyphenylene Sulfide with electrodeposited cadmium shell ☒

BODY MATERIAL:

- 2 Polyphenylene Sulfide with electroless nickel shell
- 3 Polyphenylene Sulfide with electrodeposited cadmium shell ☒

SIZE

XXX 009, 015, 021, 025, 031, 037, 051, 069, 100

SIZE

XXX 009, 015, 021, 025, 031, 037, 051, 069, 100

CONTACTS

CONTACTS/PLATING/TERMINATIONS:

161 Pin, straight, 50 μ" Au contacts (crimped stranded wire)

CONTACTS

CONTACTS/PLATING/TERMINATIONS:

261 Socket, straight, 50 μ" Au contacts (crimped stranded wire)

HARDWARE & WIRING

STYLE OF HARDWARE:

- 00 None
- 22 Two fixed jacknut assemblies (62)**
- 41 Two turning jackscrews, allen head, retaining ring (81)**
- 42 Two long turning jackscrews, allen head, retaining ring (82)**
- 43 Two turning jackscrews, slot head, retaining ring (83)**
- 44 Two long turning jackscrews, slot head, retaining ring (84)**
- 45 Two turning jackscrews, allenhead,captivated* (85)**
- 99 Keying hardware, see options below

HARDWARE & WIRING

STYLE OF HARDWARE:

- 00 None
- 22 Two fixed jacknut assemblies (62)**
- 41 Two turning jackscrews, allen head, retaining ring (81)**
- 42 Two long turning jackscrews, allen head, retaining ring (82)**
- 43 Two turning jackscrews, slot head, retaining ring (83)**
- 44 Two long turning jackscrews, slot head, retaining ring (84)**
- 45 Two turning jackscrews, allenhead,captivated* (85)**
- 99 Keying hardware, see options below

WIRING:

XX For wiring codes, see page MA-3 & MA-4

WIRING:

XX For wiring codes, see page MA-3 & MA-4

OPTIONS

- KSXX Two turning jackscrews
See page MA-6 for keying options (KJ)**
- KPXX Two fixed jacknuts
See page MA-6 for keying options (KN)**

OPTIONS

- 900 Interfacial seal
- KSXX Two turning jackscrews & interfacial sealing gasket
See page MA-6 for keying options (KJ)**
- KPXX Two fixed jacknuts & interfacial sealing gasket
See page MA-6 for keying options (KN)**

NOTES

See page MA-5 & MA-7 for hardware dimensions.
Reference PTB44 for band-it termination installation

NOTES

See page MA-5 & MA-7 for hardware dimensions.
Reference PTB44 for band-it termination installation

Stainless steel micro band for shield termination, shipped with each connector
AirBorn part number CDG10026 1/8" short, CDG17492 1/8" long
Band-it application tool - AirBorn part number CDG10027

* = Captive hardware is factory installed and non-removable.
 ** = Use numbers or letters in parenthesis when ordering size 100.
 *** = 2 Row, 51 position connectors are NON MIL-SPEC interface
 ☒ = Option not RoHS compliant



Rugged Metal Solder Cup (Integral Shield Termination)

.050"

9 thru 100 Contacts

MM

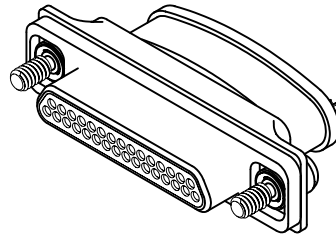

MM-2P2-031-113-4500 (PLUG)

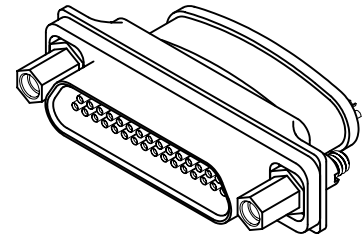

MM-2Q2-031-213-2200 (RECEPTACLE)

MATING MATRIX	
CONNECTOR	MATES WITH
MM-2P...	MK, ML, MM, MN receptacles
MM-2Q...	MK, ML, MM, MN plugs

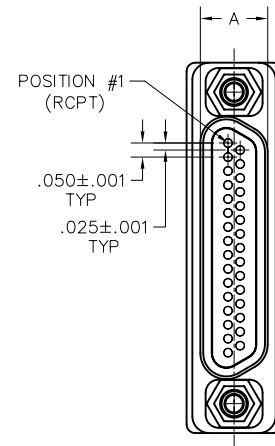
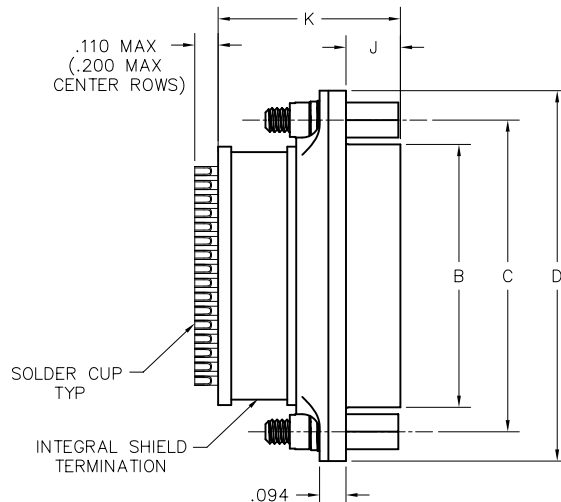
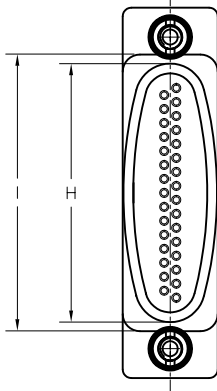

FLAT WASHER, HELICAL LOCK WASHER, SPANNER NUT, (2 PLCS)
#2-56 JACKPOST ASSY, (2 PLCS)

DIMENSIONS																	
SIZE	CONTACT ROWS	A		B		C	HARDWARE	D	E	F	G	H	I	J		K	
		PLUG MAX	RCPT MAX	PLUG MAX	RCPT MAX									PLUG	RCPT	PLUG	RCPT
9	2	.185	.251	.334	.400	.565	#2-56 UNC THD (.092 DIA THRU)	.775	.298	.340	.335	.375	.440	.183	.195	.640	.652
15				.484	.550	.715		.925				.525	.590				
21				.634	.700	.865		1.075				.675	.740				
25				.734	.800	.965		1.175				.775	.840				
31				.884	.950	1.115		1.325				.925	.990				
37				1.034	1.100	1.265		1.475				1.075	1.140				
51	3	.228	.294	1.384	1.450	1.615	#4-40 UNC THD (.147 DIA THRU)	1.825	.341	.380	.367	1.425	1.490	1.025	1.090	1.325	1.390
51				.984	1.050	1.215		1.425				1.025	1.090				
69				1.284	1.350	1.515		1.725				1.325	1.390				
100	4	.271	.394	1.384	1.508	1.800	#4-40 UNC THD (.147 DIA THRU)	2.160	.381	.430	.417	1.457	1.522				



PLUG: MM-2P2-031-113-4500

RECEPTACLE: MM-2Q2-031-213-2200



PLUG

RECEPTACLE

SERIES

MM .050" Rugged Metal Solder Cup Connector

SERIES

MM .050" Rugged Metal Solder Cup Connector

BODY

- 2 2-Row (Sizes 9 thru 37, 51)***
- 3 3-Row (Sizes 51 thru 69)
- 4 4-Row (Size 100)

BODY STYLE:
P Plug, straight, with ears and integral shield termination

BODY MATERIAL:
2 Polyphenylene Sulfide with electroless nickel shell
3 Polyphenylene Sulfide with electrodeposited cadmium shell ☒

BODY

- 2 2-Row (Sizes 9 thru 37, 51)***
- 3 3-Row (Sizes 51 thru 69)
- 4 4-Row (Size 100)

BODY STYLE:
Q Receptacle, straight, with ears and integral shield termination

BODY MATERIAL:
2 Polyphenylene Sulfide with electroless nickel shell
3 Polyphenylene Sulfide with electrodeposited cadmium shell ☒

SIZE

XXX 009, 015, 021, 025, 031, 037, 051, 069, 100

SIZE

XXX 009, 015, 021, 025, 031, 037, 051, 069, 100

CONTACTS

CONTACTS/PLATING/TERMINATIONS:
113 Pin, straight, 50 μ" Au contacts, 10 μ" Au termination
26 AWG solder cup

CONTACTS

CONTACTS/PLATING/TERMINATIONS:
213 Socket, straight, 50 μ" Au contacts, 10 μ" Au termination
26 AWG solder cup

HARDWARE & WIRING

STYLE OF HARDWARE:
00 None
22 Two fixed jacknut assemblies (62)**
41 Two turning jackscrews, allen head, retaining ring (81)**
43 Two turning jackscrews, slot head, retaining ring (83)**
45 Two turning jackscrews, allenhead,captivated* (85)**
99 Keying hardware, see options below

WIRING:
00 None

OPTIONS

KPXX Two fixed jacknuts
See page MA-6 for keying options (KN)**

HARDWARE & WIRING

STYLE OF HARDWARE:
00 None
22 Two fixed jacknut assemblies (62)**
41 Two turning jackscrews, allen head, retaining ring (81)**
43 Two turning jackscrews, slot head, retaining ring (83)**
45 Two turning jackscrews, allenhead,captivated* (85)**
99 Keying hardware, see options below

WIRING:
00 None

OPTIONS

900 Interfacial seal
KPXX Two fixed jacknuts & interfacial sealing gasket
See page MA-6 for keying options (KN)**

NOTES

See page MA-5 & MA-7 for hardware dimensions.
Reference PTB43 for solder cup termination
Reference PTB44 for band-it termination installation

Stainless steel micro band for shield termination, shipped with each connector
AirBorn part number CDG10026 1/8" short, CDG17492 1/8" long
Band-it application tool - AirBorn part number CDG10027

* = Captive hardware is factory installed and non-removable.
** = Use numbers or letters in parenthesis when ordering size 100.
*** = 2 Row, 51 position connectors are NON MIL-SPEC interface
☒ = Option not RoHS compliant

NOTES

See page MA-5 & MA-7 for hardware dimensions.
Reference PTB43 for solder cup termination
Reference PTB44 for band-it termination installation



Cable to Cable (Jumper Assembly)

.050"

9 thru 100 Contacts

Rugged Metal

MM

Rugged Plastic

MN

MM-2J2-031-PS1-22WA
(METAL)

MN-2J1-031-PS1-22WA
(PLASTIC)

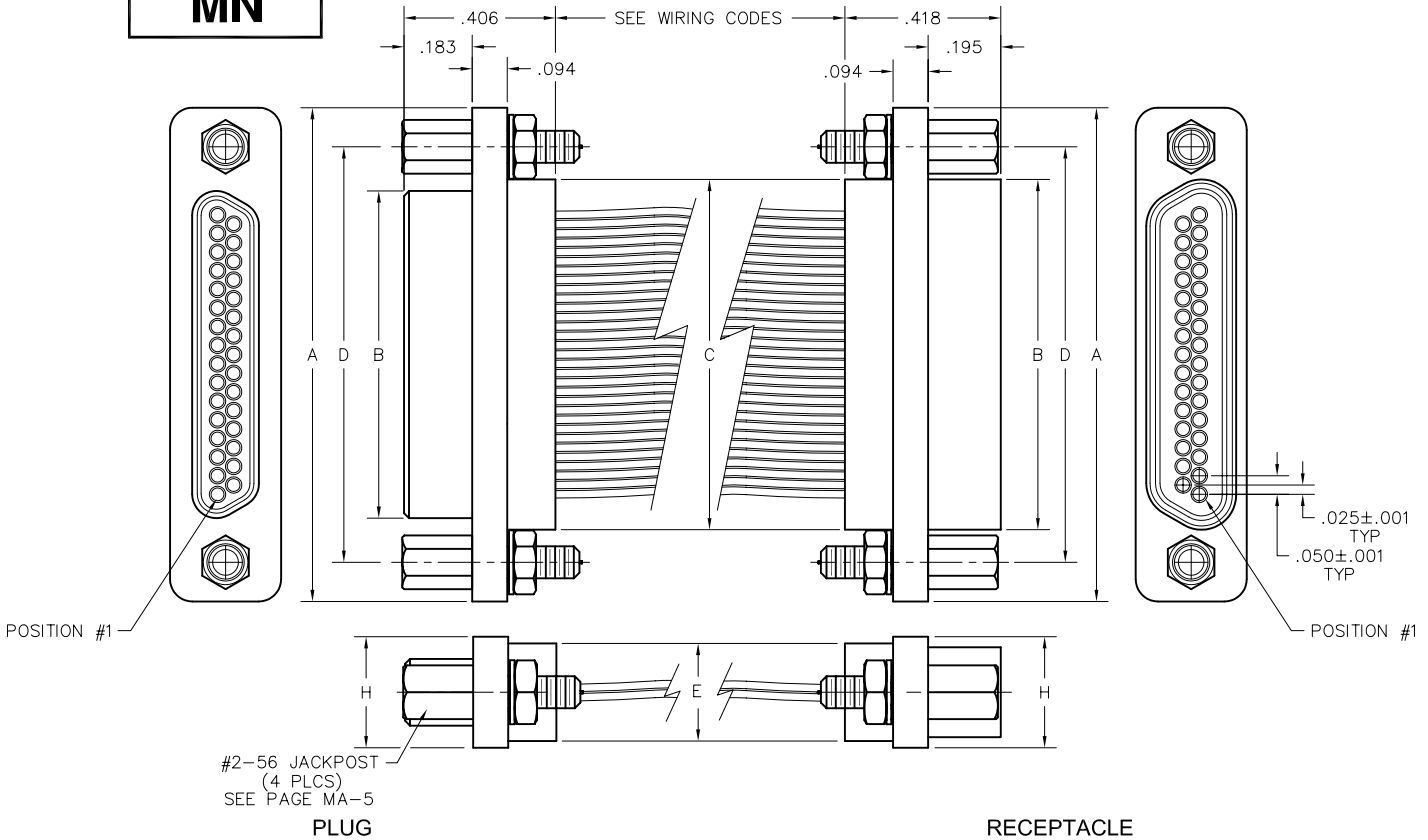
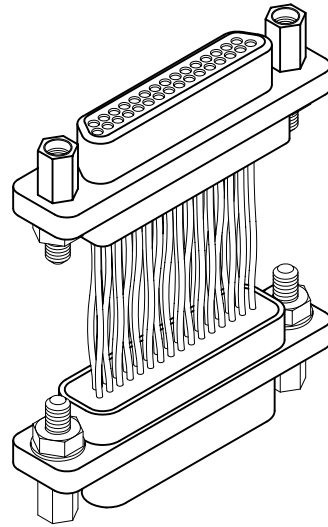

SIZE	CONTACT ROWS	DIMENSIONS						POTTING WELL MAX	H	HARDWARE
		A	B		C	D				
			PLUG MAX	RCPT MAX						
9	2	.775	.334	.400	.390	.565	.270	.298	#2-56 UNC THD (.092 DIA THRU)	
15		.925	.484	.550	.540	.715				
21		1.075	.634	.700	.690	.865				
25		1.175	.734	.800	.790	.965				
31		1.325	.884	.950	.940	1.115				
37		1.475	1.034	1.100	1.090	1.265				
51**		1.825	1.384	1.450	1.440	1.615				
51	3	1.425	.984	1.050	1.040	1.215	.310	.341	#4-40 UNC THD (.147 DIA THRU)	
69*		1.725	1.284	1.350	1.340	1.515				
100		2.160	1.384	1.508	1.432	1.800				

* = 69 POSITION CONNECTORS ARE AVAILABLE IN METAL ONLY.
 ** = 2 ROW, 51 POSITION CONNECTORS ARE AVAILABLE IN METAL ONLY,
 (NON MIL-SPEC INTERFACE).

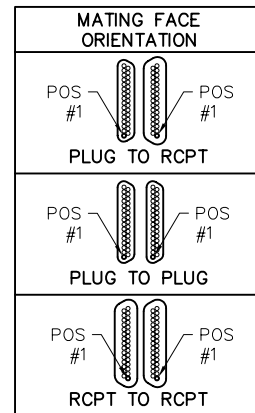

MM-2J2-031-PS1-22WA
 MN-2J1-031-PS1-22WA
 XX-XXX-XXX-XXX-XXXX-XXX

SERIES	
MM	.050" Rugged Metal I/O Connector
MN	.050" Rugged Plastic I/O Connector
(MM & MN mate with MK, ML, MM, MN assemblies)	

BODY	
2	2-Row (Sizes 9 thru 51****)
3	3-Row (Size 51 & 69***)
4	4-Row (Size 100)

BODY STYLE:
 J Jumper assembly, straight, with ears

BODY MATERIAL:

1	Polyphenylene Sulfide (MN only)
2	Polyphenylene Sulfide with electroless nickel shell
3	Polyphenylene Sulfide with electrodeposited cadmium shell <input checked="" type="checkbox"/>
4	Polyphenylene Sulfide with hard anodized black shell
5	Polyphenylene Sulfide with stainless steel shell

SIZE	
XXX	009, 015, 021, 025, 031, 037, 051****, 069***, 100

CONTACTS	
TYPE CONTACTS/TERMINATIONS:	
PP	Plug to plug
PS	Plug to receptacle
SS	Receptacle to receptacle

PLATING OPTIONS:
 1 50 μ" Au contacts (crimp wire)

HARDWARE	
STYLE OF HARDWARE:	
00	None
22	Four fixed jacknut assemblies (62*)
41	Four turning jackscrews, allen head, retaining ring (81*)
43	Four turning jackscrews, slot head, retaining ring (83*)
45	Four turning jackscrews, allen head, captivated** (85*)
46	Two fixed jacknuts and two turning jackscrews, allen head, uninstalled (86*)
47	Two fixed jacknuts and two turning jackscrews, slot head, uninstalled (87*)
99	Keying hardware, see options below. (Body material 2, 3 and 4 only)

POLARIZATION / WIRING:
 XX For wiring codes, see page MA-3 & MA-4

OPTIONS	
KSXX	Four turning jackscrews. Receptacles supplied with interfacial sealing gasket. See page MA-6 for keying options (KJ*)
KPXX	Four fixed jacknuts. Receptacles supplied with interfacial sealing gasket. See page MA-6 for keying options (KN*)
900	Interfacial sealing gasket

* = Use numbers or letters in parenthesis when ordering size 100.
 ** = Captive hardware is factory installed and non-removable.
 *** = 69 position connectors are available in metal only.
 **** = 2 row, 51 position connectors are available in metal only (non Mil-Spec interface).
 = Option not RoHS compliant



Cable to Cable

.050"

9 thru 51 Contacts

Low Profile Metal

MQ

Low Profile Plastic

MP

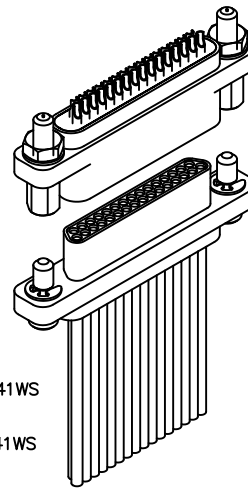

MQ-222-031-2A3-2200
(METAL)

MP-221-031-2A3-2200
(PLASTIC)

MQ-212-031-161-41WS
(METAL)

MP-211-031-161-41WS
(PLASTIC)

SEE LEAD/WIRE
LENGTH

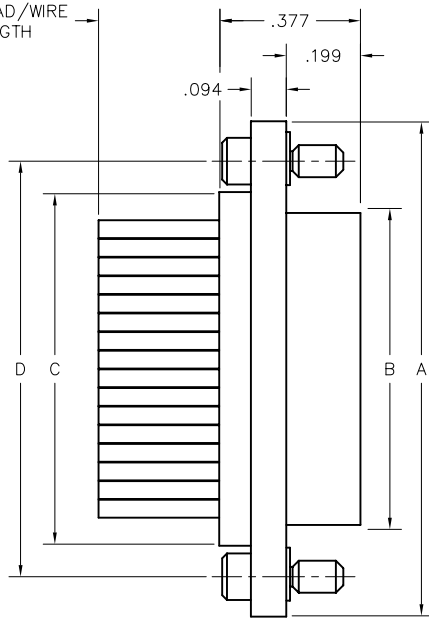

POSITION #1

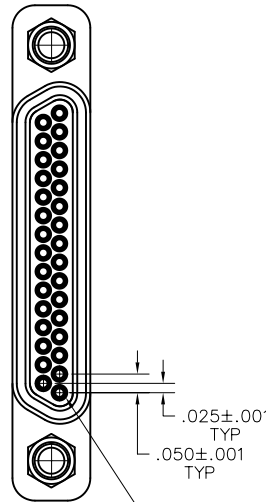
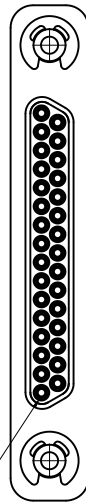

POSITION #1

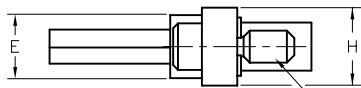
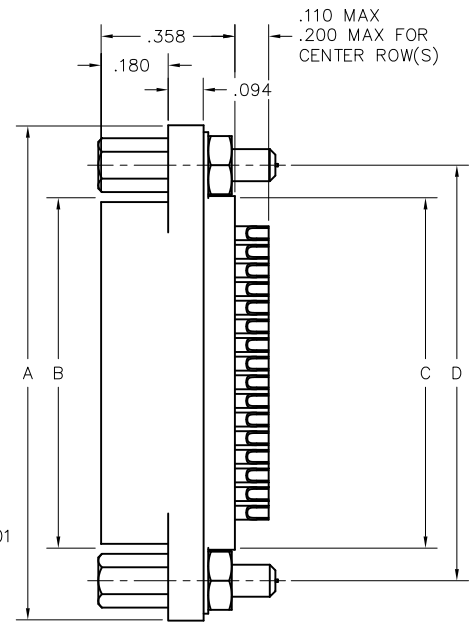

PLUG

#2-56 JACKSCREW
(2 PLCS)
SEE PAGE MA-5

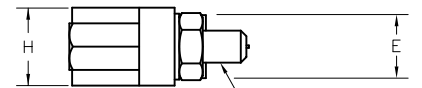

RECEPTACLE

#2-56 JACKPOST
(2 PLCS)
SEE PAGE MA-5

DIMENSIONS									
SIZE	CONTACT ROWS	A	B		C	D	E	H	HARDWARE
			PLUG MAX	RCPT MAX					
9	2	.778	.292	.378	.398	.565	.173	.208	#2-56 UNC THD (.092 DIA THRU)
15		.928	.442	.528	.548	.715			
21		1.078	.592	.678	.698	.865			
25		1.178	.692	.778	.798	.965			
31		1.328	.842	.928	.948	1.115			
37		1.478	.992	1.078	1.098	1.265			
51	3	1.428	.942	1.028	1.048	1.215	.220	.250	

PLUG: MQ-212-031-161-41WS
RECEPTACLE: MQ-222-031-2G3-4500
PLUG: MP-211-031-161-41WS
RECEPTACLE: MP-221-031-2G3-4500
 XX-XXX-XXX-XXX-XXXX-XXX

PLUG		RECEPTACLE	
SERIES			
MQ .050" Low Profile Metal I/O Connector	MP .050" Low Profile Plastic I/O Connector	MQ .050" Low Profile Metal I/O Connector	MP .050" Low Profile Plastic I/O Connector
(MQ & MP mate with MP, MQ, MR, MS receptacles)		(MQ & MP mate with MP, MQ, MR, MS plugs)	
BODY			
2 2-Row (Sizes 9 thru 37)	3 3-Row (Size 51)	2 2-Row (Sizes 9 thru 37)	3 3-Row (Size 51)
BODY STYLE:		BODY STYLE:	
1 Plug, straight, with ears		2 Receptacle, straight, with ears	
BODY MATERIAL:		BODY MATERIAL:	
1 Polyphenylene Sulfide (MN only)	2 Polyphenylene Sulfide with electroless nickel shell	1 Polyphenylene Sulfide (MN only)	2 Polyphenylene Sulfide with electroless nickel shell
3 Polyphenylene Sulfide with electrodeposited cadmium shell <input checked="" type="checkbox"/>	4 Polyphenylene Sulfide with hard anodized black shell	3 Polyphenylene Sulfide with electrodeposited cadmium shell <input checked="" type="checkbox"/>	4 Polyphenylene Sulfide with hard anodized black shell
SIZE			
XXX 009, 015, 021, 025, 031, 037, 051		XXX 009, 015, 021, 025, 031, 037, 051	
CONTACTS			
TYPE CONTACTS/TERMINATIONS:		TYPE CONTACTS/TERMINATIONS:	
11 Pin, straight, 26 awg solder cup	1A Pin, straight, 24 awg solder cup	21 Socket, straight, 26 awg solder cup	2A Socket, straight, 24 awg solder cup
1D Pin, straight, .109" Lead Length (.018 dia) SEE NOTE 1	1E Pin, straight, .125" Lead Length (.018 dia) SEE NOTE 1	2D Socket, straight, .109" Lead Length (.018 dia)	2E Socket, straight, .125" Lead Length (.018 dia)
1F Pin, straight, .140" Lead Length (.018 dia) SEE NOTE 1	1G Pin, straight, .156" Lead Length (.018 dia) SEE NOTE 1	2F Socket, straight, .140" Lead Length (.018 dia)	2G Socket, straight, .156" Lead Length (.018 dia)
12 Pin, straight, .150" Lead Length (.018 dia) SEE NOTE 1	1H Pin, straight, .172" Lead Length (.018 dia) SEE NOTE 1	22 Socket, straight, .150" Lead Length (.018 dia)	2H Socket, straight, .172" Lead Length (.018 dia)
1J Pin, straight, .187" Lead Length (.018 dia) SEE NOTE 1	1K Pin, straight, .250" Lead Length (.018 dia) SEE NOTE 1	2J Socket, straight, .187" Lead Length (.018 dia)	2K Socket, straight, .250" Lead Length (.018 dia)
13 Pin, straight, .375" Lead Length (.018 dia) SEE NOTE 1	14 Pin, straight, .500" Lead Length (.018 dia) SEE NOTE 1	2L Socket, straight, .375" Lead Length (.018 dia)	2M Socket, straight, .500" Lead Length (.018 dia)
15 Pin, straight, 1.000" Lead Length (.018 dia) SEE NOTE 1	16 Pin, straight, crimped wire	2N Socket, straight, 1.000" Lead Length (.018 dia)	2P Socket, straight, .500" Lead Length (.018 dia) SEE NOTE 1
		25 Socket, straight, 1.000" Lead Length (.018 dia) SEE NOTE 1	26 Socket, straight, crimped wire
PLATING OPTIONS:		PLATING OPTIONS:	
1 50 μ" Au contacts (crimp wire)	3 50 μ" Au contacts (solder cup, pigtail)	1 50 μ" Au contacts (crimp wire)	3 50 μ" Au contacts (solder cup, pigtail)
5 50 μ" Au contacts; Sn/Pb alloy terminations <input checked="" type="checkbox"/>	7 50 μ" Au contacts; SAC305 terminations	5 50 μ" Au contacts; Sn/Pb alloy terminations <input checked="" type="checkbox"/>	7 50 μ" Au contacts; SAC305 terminations
HARDWARE			
STYLE OF HARDWARE:		STYLE OF HARDWARE:	
00 None	22 Two fixed jacknut assemblies (62°)	00 None	22 Two fixed jacknut assemblies (62°)
41 Two turning jackscrews, allen head, retaining ring (81°)	42 Two long turning jackscrews, allen head, retaining ring (82°)	41 Two turning jackscrews, allen head, retaining ring (81°)	42 Two long turning jackscrews, allen head, retaining ring (82°)
43 Two turning jackscrews, slot head, retaining ring (83°)	44 Two long turning jackscrews, slot head, retaining ring (84°)	43 Two turning jackscrews, slot head, retaining ring (83°)	44 Two long turning jackscrews, slot head, retaining ring (84°)
45 Two turning jackscrews, allen head, captivated** (85°)	99 Keying hardware, see options below. (Body material 2, 3 and 4 only)	45 Two turning jackscrews, allen head, captivated** (85°)	99 Keying hardware, see options below. (Body material 2, 3 and 4 only)
POLARIZATION / WIRING		POLARIZATION / WIRING	
00 None	XX For wiring codes, see page MA-3 & MA-4	00 None	XX For wiring codes, see page MA-3 & MA-4
OPTIONS			
KSXX Two turning jackscrews. See page MA-6 for keying options		KSXX Two turning jackscrews and interfacial sealing gasket. See page MA-6 for keying options	
KPXX Two fixed jacknuts. See page MA-6 for keying options		KPXX Two fixed jacknuts and interfacial sealing gasket. See page MA-6 for keying options	

** = Captive hardware is factory installed and non-removable.

NOTE 1 = The leads on these contacts are soft copper suitable for forming.

= Option not RoHS compliant



Cable to Cable (Jumper Assembly)

.050"

9 thru 51 Contacts

Low Profile Metal

MQ

Low Profile Plastic

MP

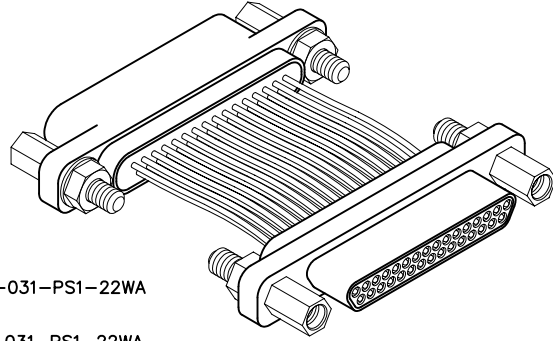

MQ-2J2-031-PS1-22WA
(METAL)

MP-2J1-031-PS1-22WA
(PLASTIC)

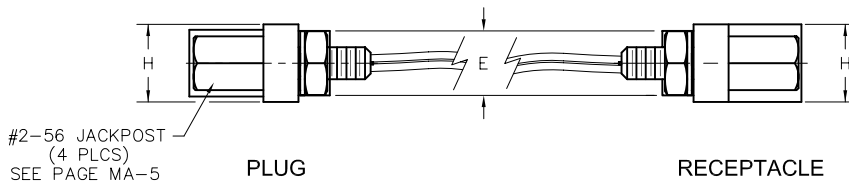
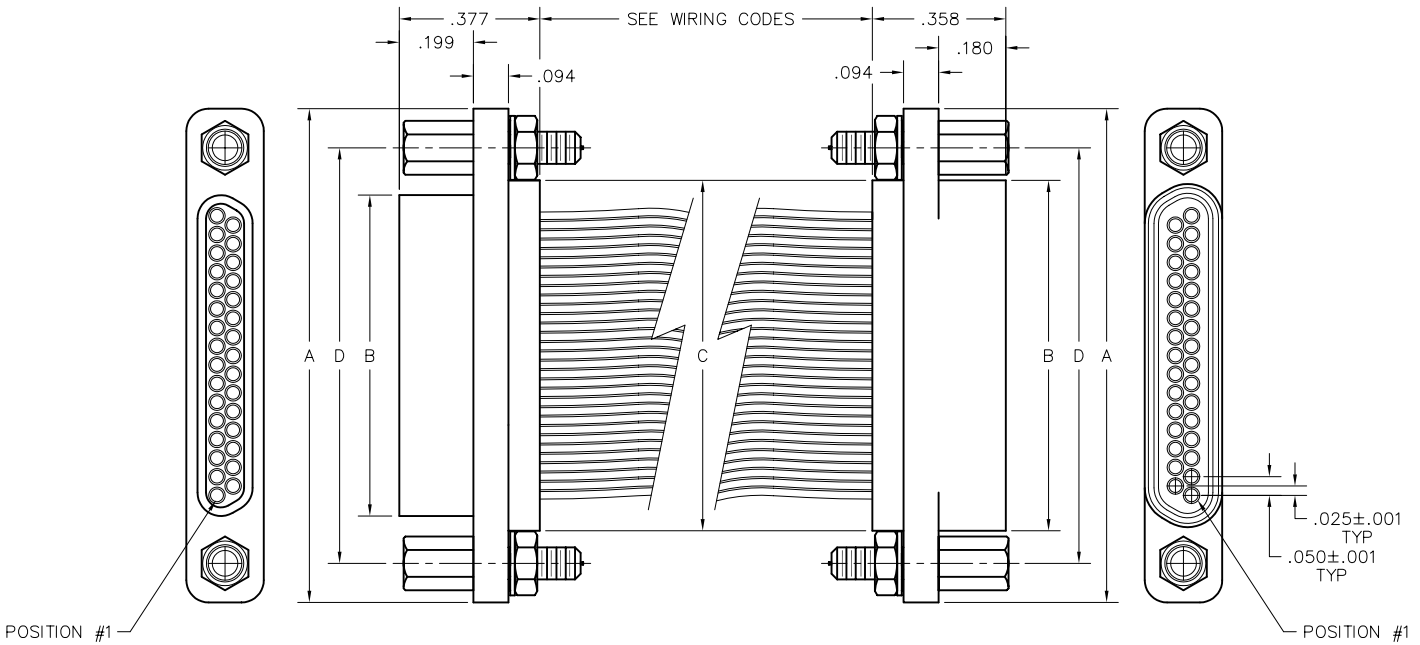

SIZE	CONTACT ROWS	A	B		C	D	E	H	HARDWARE
			PLUG MAX	RCPT MAX					
9	2	.778	.292	.378	.398	.565	.173	.208	#2-56 UNC THD (.092 DIA THRU)
15		.928	.442	.528	.548	.715			
21		1.078	.592	.678	.698	.865			
25		1.178	.692	.778	.798	.965			
31		1.328	.842	.928	.948	1.115			
37		1.478	.992	1.078	1.098	1.265			
51	3	1.428	.942	1.028	1.048	1.215	.220	.250	

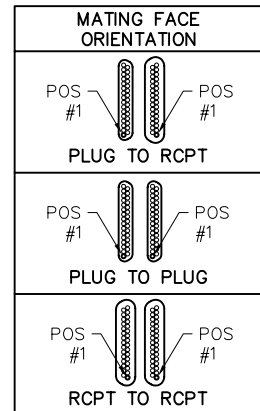

MQ- 2J2-031 - PS1-22WA
 MP- 2J1 -031 - PS1-22WA
 XX-XXX-XXX-XXX-XXXX-XXXX

SERIES	
MQ	.050" Low Profile Metal I/O Connector
MP	.050" Low Profile Plastic I/O Connector
(MQ & MP mate with MP, MQ, MR, MS receptacles)	

BODY	
2	2-Row (Sizes 9 thru 37)
3	3-Row (Size 51)
BODY STYLE:	
J	Jumper assembly, straight, with ears
BODY MATERIAL:	
1	Polyphenylene Sulfide (MP only)
2	Polyphenylene Sulfide with electroless nickel shell
3	Polyphenylene Sulfide with electrodeposited cadmium shell <input checked="" type="checkbox"/>
4	Polyphenylene Sulfide with hard anodized black shell

SIZE	
XXX 009, 015, 021, 025, 031, 037, 051	

CONTACTS	
TYPE CONTACTS/TERMINATIONS:	
PP	Plug to plug
PS	Plug to receptacle
SS	Receptacle to receptacle
PLATING OPTIONS:	
1	50 μ" Au contacts (crimp wire)

HARDWARE	
STYLE OF HARDWARE:	
00	None
22	Four fixed jacknut assemblies
41	Four turning jackscrews, allen head, retaining ring
43	Four turning jackscrews, slot head, retaining ring
45	Four turning jackscrews, allen head, captivated**
46	Two fixed jacknuts and two turning jackscrews, allen head, uninstalled
47	Two fixed jacknuts and two turning jackscrews, slot head, uninstalled
99	Keying hardware, see options below. (Body material 2, 3 and 4 only)
POLARIZATION / WIRING:	
XX	For wiring codes, see page MA-3 & MA-4

OPTIONS	
KSXX	Four turning jackscrews. See page MA-6 for keying options
KPXX	Four fixed jacknuts. See page MA-6 for keying options

** = Captive hardware is factory installed and non-removable.
 = Option not RoHS compliant



Right Angle Boardmount (Narrow Footprint)

.050"
9 thru 100 Contacts

MK, ML

MK-252-031-335-220S (PLUG)

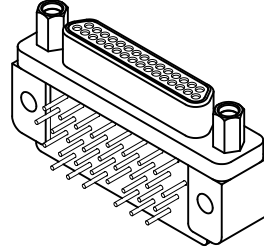

MK-262-031-445-220S (RCPT)

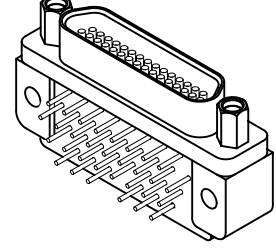

MATING MATRIX	
CONNECTOR	MATES WITH
MK-25...	MK, ML, MM, MN receptacles
ML-25...	MK, ML, MM, MN receptacles
MK-26..	MK, ML, MM, MN plugs
ML-26..	MK, ML, MM, MN plugs

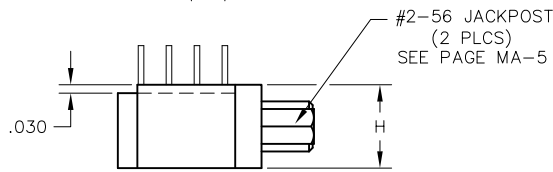
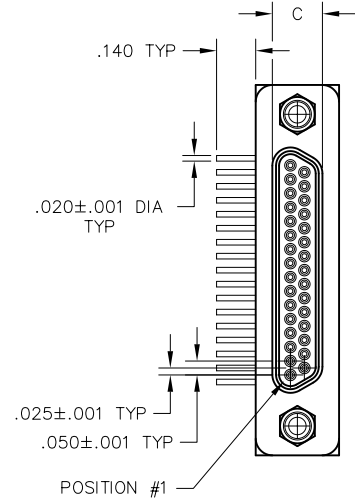
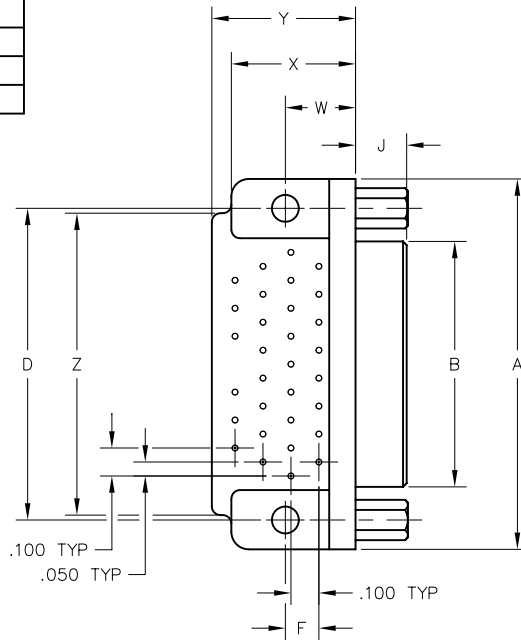

(PLUG SHOWN)

DIMENSIONS																			
SIZE	CONTACT ROWS	A	B		C		D	F	H	J		W	X MAX	Y MAX	Z	HARDWARE	MOUNTING HOLE		
			PLUG MAX	RCPT MAX	PLUG MAX	RCPT MAX				PLUG	RCPT								
9	2	.775	.334	.400	.185	.251	.565	.020	.298	.183	.195	.250	.420	.420	.775	#2-56 UNC THD	.096 DIA OR #2-56 UNC THREADED INSERT		
15		.925	.484	.550			.715											1.075	.925
21		1.075	.634	.700			.865											1.175	1.075
25		1.175	.734	.800			.965											1.325	1.175
31		1.325	.884	.950			1.115											1.475	1.325
37		1.475	1.034	1.100			1.265												1.180
51	3	1.425	.984	1.050	.228	.294	1.215	.150	.341	.300	.430	.650	1.220	.755	1.450	#4-40 UNC THD	.125 DIA #2-56 UNC INSERT #4-40 UNC INSERT		
69		1.725	1.284	1.350			1.515											1.450	
100		2.160	1.384	1.508			.271											.394	1.800

PLUG: MK-252-031-335-220S
RECEPTACLE: MK-262-031-445-220S
 XX-XXX-XXX-XXX-XXXX-XXX
 | | | | |
 BODY CONTACTS OPTIONS
 SERIES SIZE HARDWARE

PLUG

RECEPTACLE

SERIES

MK .050" Rugged Metal PC Board Mount Connector
 ML .050" Rugged Plastic PC Board Mount Connector
 (MK & ML mate with MK, ML, MM, MN, receptacles)

BODY

- 2 2-Row (Sizes 9 thru 37)
 - 3 3-Row (Size 51 & 69***)
 - 4 4-Row (Size 100)
- BODY STYLE:
- 5 Plug, right angle, narrow footprint, w/ mounting holes
- BODY MATERIAL:
- 1 Polyphenylene Sulfide (ML only)
 - 2 Electroless nickel shell w/ PPS insulator
 - 3 Electrodeposited cadmium shell w/ PPS insulator
 - 4 Hard anodized black shell w/ PPS insulator
 - 5 Stainless steel shell w/ PPS insulator

SIZE

XXX 009, 015, 021, 025, 031, 037, 051, 069***, 100

CONTACTS

- TYPE CONTACTS/TERMINATIONS:
- 32 Pin, right angle, PCB leads, .109"
 - 33 Pin, right angle, PCB leads, .140"
 - 34 Pin, right angle, PCB leads, .172"

- PLATING OPTIONS:
- 3 50 μ" Au contacts: Au terminations
 - 5 50 μ" Au contacts: Sn/Pb alloy terminations
 - 7 50 μ" Au contacts: SAC305 terminations

HARDWARE

- STYLE OF HARDWARE:
- 00 None
 - 22 Two fixed jacknuts (62*)
 - 41 Two turning jackscrews, allen head, retaining ring****(81*)
 - 99 Keying hardware, see options below (Body material 2, 3 and 4 only)
- POLARIZATION / WIRING:
- 0R Reversed body polarization
 - 0S Standard body polarization

OPTIONS

- KPXX Two fixed jacknuts (KN*)
- 94P Mil-Spec footprint (size 100 only), standard body polarization
- 0B7 #2-56 threaded inserts, standard body polarization
- 0BJ Mil-Spec footprint (size 100 only) with #2-56 threaded inserts, standard body polarization
- 0H7 #4-40 threaded inserts (size 100 only), standard body polarization
- 0H6 Mil-Spec footprint (size 100 only) with #4-40 threaded inserts, standard body polarization

NOTES

- See page MA-6 for keying options
- * = Use numbers in parenthesis when ordering size 100.
 - *** = 69 position connectors are available in metal only.
 - **** = Connector body has no mounting holes.
 - = Option not RoHS compliant

SERIES

MK .050" Rugged Metal PC Board Mount Connector
 ML .050" Rugged Plastic PC Board Mount Connector
 (MK & ML mate with MK, ML, MM, MN plugs)

BODY

- 2 2-Row (Sizes 9 thru 37)
 - 3 3-Row (Size 51 & 69***)
 - 4 4-Row (Size 100)
- BODY STYLE:
- 6 Receptacle, right angle, narrow footprint, w/ mounting holes
- BODY MATERIAL:
- 1 Polyphenylene Sulfide (ML only)
 - 2 Electroless nickel shell w/ PPS insulator
 - 3 Electrodeposited cadmium shell w/ PPS insulator
 - 4 Hard anodized black shell w/ PPS insulator
 - 5 Stainless steel shell w/ PPS insulator

SIZE

XXX 009, 015, 021, 025, 031, 037, 051, 069***, 100

CONTACTS

- TYPE CONTACTS/TERMINATIONS:
- 43 Socket, right angle, PCB leads, .109"
 - 44 Socket, right angle, PCB leads, .140"
 - 45 Socket, right angle, PCB leads, .172"

- PLATING OPTIONS:
- 3 50 μ" Au contacts: Au terminations
 - 5 50 μ" Au contacts: Sn/Pb alloy terminations
 - 7 50, u" Au contacts: SAC305 terminations

HARDWARE

- STYLE OF HARDWARE:
- 00 None
 - 22 Two fixed jacknuts (62*)
 - 41 Two turning jackscrews, allen head, retaining ring****(81*)
 - 99 Keying hardware, see options below (Body material 2, 3 and 4 only)
- POLARIZATION / WIRING:
- 0R Reversed body polarization
 - 0S Standard body polarization

OPTIONS

- KPXX Two fixed jacknuts (KN*) and interfacial sealing gasket.
- 900 Interfacial sealing gasket
- 0B7 #2-56 Threaded inserts and interfacial sealing gasket standard body polarization
- 0H7 #4-40 threaded inserts (size 100 only), and interfacial sealing gasket, standard body polarization

NOTES

- See page MA-6 for keying options
- * = Use numbers in parenthesis when ordering size 100.
 - *** = 69 position connectors are available in metal only.
 - **** = Connector body has no mounting holes.
 - = Option not RoHS compliant



Right Angle Boardmount (Thru Clearance Cut)

.050"
9 thru 100 Contacts

MK

MK-2R2-031-335-220S
(PLUG)

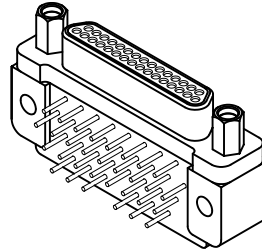

MK-2S2-031-445-220S
(RCPT)

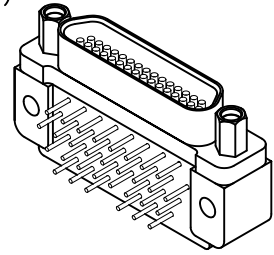

MATING MATRIX	
CONNECTOR	MATES WITH
MK-2R...	MK, ML, MM, MN receptacles
MK-2S..	MK, ML, MM, MN plugs

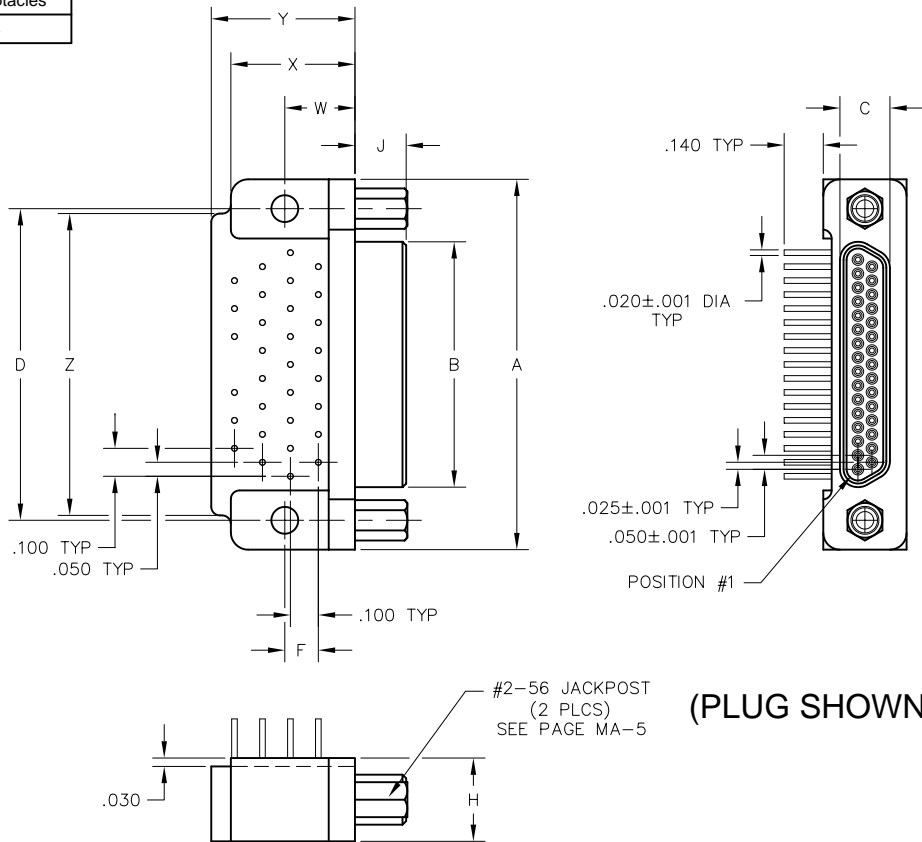

DIMENSIONS																	
SIZE	CONTACT ROWS	A	B		C		D	F	H	J		W	X MAX	Y MAX	Z	HARDWARE	MOUNTING HOLE
			PLUG MAX	RCPT MAX	PLUG MAX	RCPT MAX				PLUG	RCPT						
9	2	.775	.334	.400	.185	.251	.565	.020	.298	.183	.195	.250	.420	.420	.775	#2-56 UNC THD	.096 DIA OR #2-56 UNC THREADED INSERT
15		.925	.484	.550			.715	.925									
21		1.075	.634	.700			.865	1.075									
25		1.175	.734	.800			.965	1.175									
31		1.325	.884	.950			1.115	1.080									
37		1.475	1.034	1.100			1.265	1.180									
51	3	1.425	.984	1.050	.228	.294	1.215	.150	.341	.300	.430	.650	1.220	.755	1.450		
69		1.725	1.284	1.350			1.515										

PLUG: MK-2R2-031-335-220S
RECEPTACLE: MK-2S2-031-445-220S
XX-XXX-XXX-XXX-XXXX-XXX
 | | | |
 BODY CONTACTS OPTIONS
 SERIES SIZE HARDWARE

PLUG

SERIES

MK .050" Rugged Metal PC Board Mount Connector (MK mates with MK, ML, MM, MN, receptacles)

BODY

- 2 2-Row (Sizes 9 thru 37)
- 3 3-Row (Size 51 & 69)
- BODY STYLE: Blind Cut
- R Plug, right angle (thru clearance cut), narrow footprint, w/ mounting holes
- BODY MATERIAL:
- 2 Electroless nickel shell w/ PPS insulator
- 3 Electrodeposited cadmium shell w/ PPS insulator
- 4 Hard anodized black shell w/ PPS insulator
- 5 Stainless steel shell w/ PPS insulator

SIZE

XXX 009, 015, 021, 025, 031, 037, 051, 069

CONTACTS

- TYPE CONTACTS/TERMINATIONS:
- 32 Pin, right angle, PCB leads, .109"
 - 33 Pin, right angle, PCB leads, .140"
 - 34 Pin, right angle, PCB leads, .172"
- PLATING OPTIONS:
- 3 50 μ" Au contacts: Au terminations
 - 5 50 μ" Au contacts; Sn/Pb alloy terminations
 - 7 50 μ" Au contacts; SAC305 terminations

HARDWARE

- STYLE OF HARDWARE:
- 00 None
 - 22 Two fixed jacknuts
 - 41 Two turning jackscrews, allen head, retaining ring****
 - 99 Keying hardware, see options below (Body material 2, 3 and 4 only)
- POLARIZATION / WIRING:
- 0R Reversed body polarization
 - 0S Standard body polarization

OPTIONS

- KPXX Two fixed jacknuts
- 0B7 Threaded inserts, standard body polarization

NOTES

See page MA-6 for keying options
 **** = Connector body has no mounting holes.
 = Option not RoHS compliant

RECEPTACLE

SERIES

MK .050" Rugged Metal PC Board Mount Connector (MK mates with MK, ML, MM, MN plugs)

BODY

- 2 2-Row (Sizes 9 thru 37)
- 3 3-Row (Size 51 & 69)
- BODY STYLE: Blind Cut
- S Receptacle, right angle (thru clearance cut), narrow footprint, w/ mounting holes
- BODY MATERIAL:
- 2 Electroless nickel shell w/ PPS insulator
- 3 Electrodeposited cadmium shell w/ PPS insulator
- 4 Hard anodized black shell w/ PPS insulator
- 5 Stainless steel shell w/ PPS insulator

SIZE

XXX 009, 015, 021, 025, 031, 037, 051, 069

CONTACTS

- TYPE CONTACTS/TERMINATIONS:
- 43 Socket, right angle, PCB leads, .109"
 - 44 Socket, right angle, PCB leads, .140"
 - 45 Socket, right angle, PCB leads, .172"
- PLATING OPTIONS:
- 3 50 μ" Au contacts: Au terminations
 - 5 50 μ" Au contacts; Sn/Pb alloy terminations
 - 7 50, u" Au contacts; SAC305 terminations

HARDWARE

- STYLE OF HARDWARE:
- 00 None
 - 22 Two fixed jacknuts
 - 41 Two turning jackscrews, allen head, retaining ring****
 - 99 Keying hardware, see options below (Body material 2, 3 and 4 only)
- POLARIZATION / WIRING:
- 0R Reversed body polarization
 - 0S Standard body polarization

OPTIONS

- KPXX Two fixed jacknuts and interfacial sealing gasket.
- 900 Interfacial sealing gasket
- 0B7 Threaded inserts and interfacial sealing gasket, standard body polarization.

NOTES

See page MA-6 for keying options
 **** = Connector body has no mounting holes.
 = Option not RoHS compliant



Right Angle Boardmount (Blind Clearance Cut)

.050"
9 thru 100 Contacts

MK

MK-2T2-031-335-220S
(PLUG)

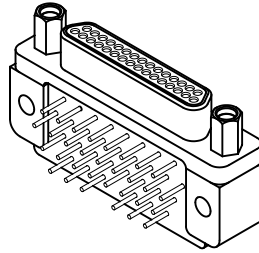

MK-2V2-031-445-220S
(RCPT)

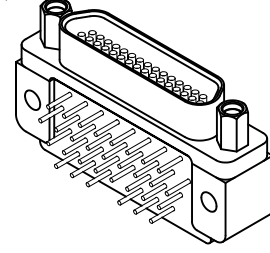

MATING MATRIX	
CONNECTOR	MATES WITH
MK-2T...	MK, ML, MM, MN receptacles
MK-2V..	MK, ML, MM, MN plugs

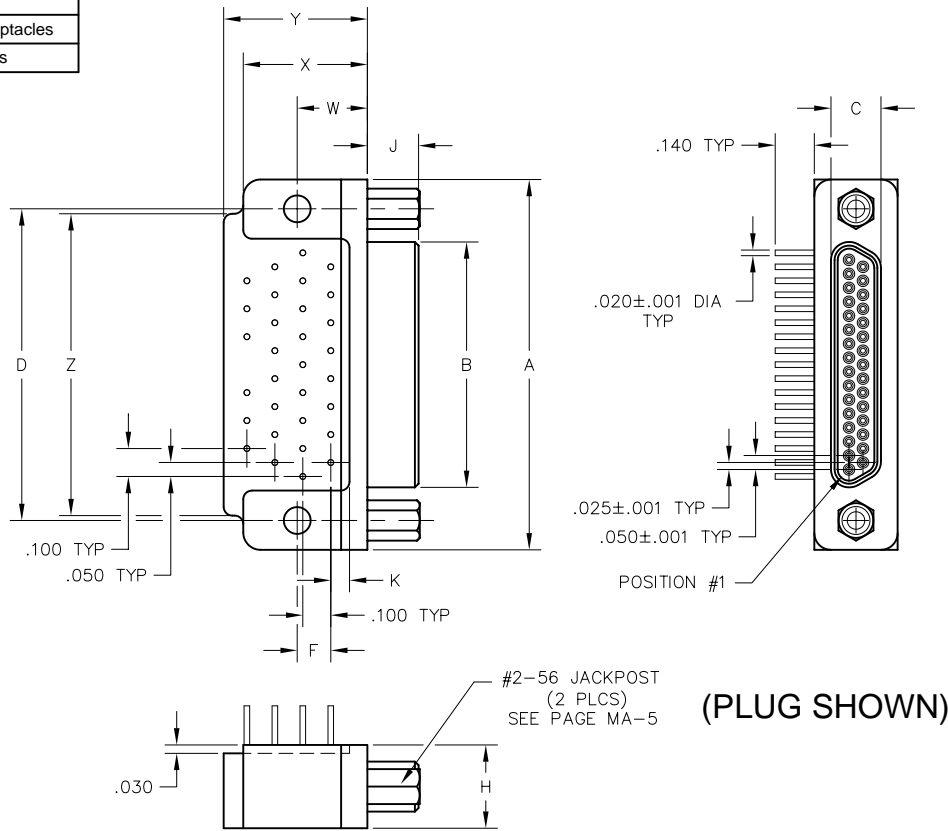

SIZE	CONTACT ROWS	A	B		C		D	F	H	J		K	W	X MAX	Y MAX	Z	HARDWARE	MOUNTING HOLE	
			PLUG MAX	RCPT MAX	PLUG MAX	RCPT MAX				PLUG	RCPT								
9	2	.775	.334	.400	.185	.251	.565	.020	.298	.183	.195	.067	.250	.420	.420	.775	#2-56 UNC THD	.096 DIA OR #2-56 UNC THREADED INSERT	
15		.925	.484	.550			.715												.925
21		1.075	.634	.700			.865												1.075
25		1.175	.734	.800			.965												1.175
31		1.325	.884	.950			1.115												1.325
37	1.475	1.034	1.100	1.265	1.475														
51	3	1.425	.984	1.050	.228	.294	1.215	.150	.341	.087	.300	.430	.650	1.220	1.220	#4-40 UNC THD	.125 DIA		
69		1.725	1.284	1.350			1.515											.755	1.450
100	4	2.160	1.384	1.508	.271	.394	1.800	.200	.384	.137	.400	.590	1.000	1.810		#4-40 UNC THD	#2-56 UNC INSERT #4-40 UNC INSERT		

PLUG: MK-2T2-031-335-220S
RECEPTACLE: MK-2V2-031-445-220S
 XX-XXX-XXX-XXX-XXXX-XXX
 | | | | | |
 BODY CONTACTS OPTIONS
 SERIES SIZE HARDWARE

PLUG

RECEPTACLE

SERIES

MK .050" Rugged Metal PC Board Mount Connector
(MK mates with MK, ML, MM, MN, receptacles)

BODY

- 2 2-Row (Sizes 9 thru 37)
 - 3 3-Row (Size 51 & 69)
 - 4 4-Row (Size 100)
- BODY STYLE: Blind Cut
- T Plug, right angle (blind clearance cut), narrow footprint, w/ mounting holes
- BODY MATERIAL:
- 2 Electroless nickel shell w/ PPS insulator
 - 3 Electrodeposited cadmium shell w/ PPS insulator
 - 4 Hard anodized black shell w/ PPS insulator
 - 5 Stainless steel shell w/ PPS insulator

SIZE

XXX 009, 015, 021, 025, 031, 037, 051, 069, 100

CONTACTS

- TYPE CONTACTS/TERMINATIONS:
- 32 Pin, right angle, PCB leads, .109"
 - 33 Pin, right angle, PCB leads, .140"
 - 34 Pin, right angle, PCB leads, .172"
- PLATING OPTIONS:
- 3 50 μ" Au contacts: Au terminations
 - 5 50 μ" Au contacts; Sn/Pb alloy terminations
 - 7 50 μ" Au contacts; SAC305 terminations

HARDWARE

- STYLE OF HARDWARE:
- 00 None
 - 22 Two fixed jacknuts (62*)
 - 41 Two turning jackscrews, allen head, retaining ring****(81*)
 - 99 Keying hardware, see options below (Body material 2, 3 and 4 only)
- POLARIZATION / WIRING:
- 0R Reversed body polarization
 - 0S Standard body polarization

OPTIONS

- KPXX Two fixed jacknuts (KN*)
- 94P Mil-Spec footprint (size 100 only), standard body polarization
- 0B7 #2-56 threaded inserts, standard body polarization
- 0BJ Mil-Spec footprint (size 100 only) with #2-56 threaded inserts, standard body polarization
- 0H7 #4-40 threaded inserts (size 100 only), standard body polarization
- 0H6 Mil-Spec footprint (size 100 only) with #4-40 threaded inserts, standard body polarization

NOTES

- See page MA-6 for keying options
 * = Use numbers in parenthesis when ordering size 100.
 **** = Connector body has no mounting holes.
 = Option not RoHS compliant

SERIES

MK .050" Rugged Metal PC Board Mount Connector
(MK mates with MK, ML, MM, MN plugs)

BODY

- 2 2-Row (Sizes 9 thru 37)
 - 3 3-Row (Size 51 & 69)
 - 4 4-Row (Size 100)
- BODY STYLE: Blind Cut
- V Receptacle, right angle (blind clearance cut), narrow footprint, w/ mounting holes
- BODY MATERIAL:
- 2 Electroless nickel shell w/ PPS insulator
 - 3 Electrodeposited cadmium shell w/ PPS insulator
 - 4 Hard anodized black shell w/ PPS insulator
 - 5 Stainless steel shell w/ PPS insulator

SIZE

XXX 009, 015, 021, 025, 031, 037, 051, 069, 100

CONTACTS

- TYPE CONTACTS/TERMINATIONS:
- 43 Socket, right angle, PCB leads, .109"
 - 44 Socket, right angle, PCB leads, .140"
 - 45 Socket, right angle, PCB leads, .172"
- PLATING OPTIONS:
- 3 50 μ" Au contacts: Au terminations
 - 5 50 μ" Au contacts; Sn/Pb alloy terminations
 - 7 50, u" Au contacts; SAC305 terminations

HARDWARE

- STYLE OF HARDWARE:
- 00 None
 - 22 Two fixed jacknuts (62*)
 - 41 Two turning jackscrews, allen head, retaining ring****(81*)
 - 99 Keying hardware, see options below (Body material 2, 3 and 4 only)
- POLARIZATION / WIRING:
- 0R Reversed body polarization
 - 0S Standard body polarization

OPTIONS

- KPXX Two fixed jacknuts (KN*) and interfacial sealing gasket.
- 900 Interfacial sealing gasket
- 0B7 #2-56 Threaded inserts and interfacial sealing gasket, standard body polarization
- 0H7 #4-40 threaded inserts (size 100 only), and interfacial sealing gasket, standard body polarization

NOTES

- See page MA-6 for keying options
 * = Use numbers in parenthesis when ordering size 100.
 **** = Connector body has no mounting holes.
 = Option not RoHS compliant

TO FLEX CABLE

.050"

9 thru 100 Contacts

Rugged Board Mount

MK, ML

Flex Cable

MK, ML

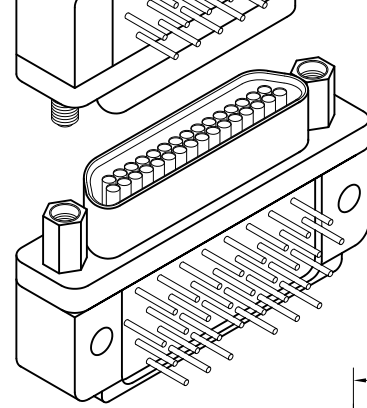

MK-263-031-44
(METAL)

ML-261-031-44
(PLASTIC)

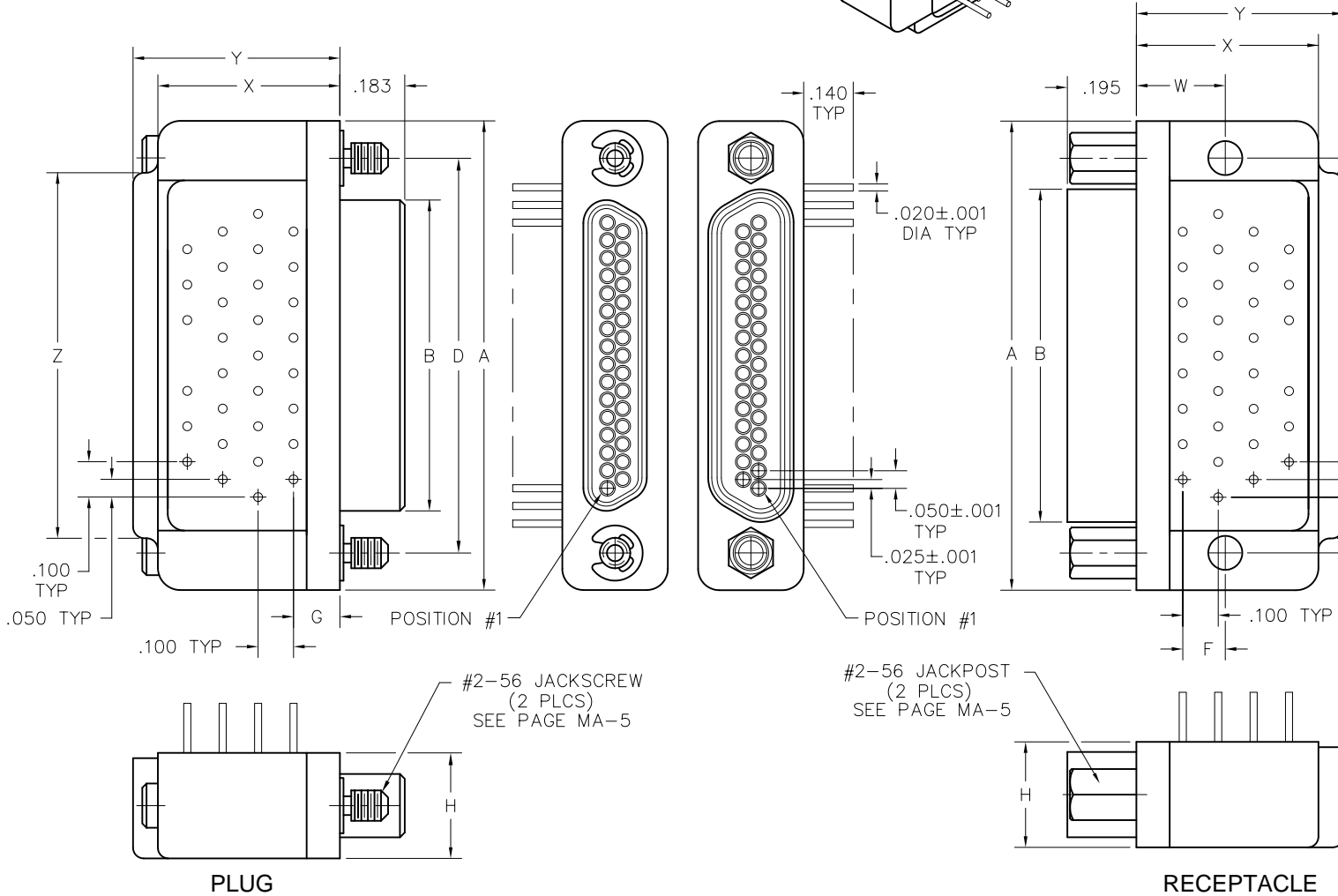

DIMENSIONS													HARDWARE	MOUNT HOLE												
SIZE	CONTACT ROWS	A	B		D	F	G	H	W	X MAX	Y MAX	Z														
			PLUG MAX	RCPT MAX																						
9	2	.775	.334	.400	.565	.020	.230	.298	.250	.420	.420	.775	#2-56 UNC THD	.096 DIA OR #2-56 THREAD INSEPT												
15		.925	.484	.550	.715	.120	.130					.180			.250	.420	.420	.925								
21		1.075	.634	.700	.865													.150	.150	.341	.300	.430	.650	1.075		
25		1.175	.734	.800	.965																			1.220	1.450	1.175
31		1.325	.884	.950	1.115																					1.080
37		1.475	1.034	1.100	1.265						1.180															
51	3	1.425	.984	1.050	1.215	.150	.150	.341	.300	.430	.650	1.220	#4-40 UNC THD	.125 DIA #2-56 THREAD INSEPT												
69*		1.725	1.284	1.350	1.515						.755	1.450														
100	4	2.160	1.384	1.508	1.800	.200	.200	.384	.400	.590	1.000	1.810														

* = 69 POSITION CONNECTORS ARE AVAILABLE IN METAL ONLY.

PLUG: MK-253-031-335-410S

RECEPTACLE: MK-263-031-445-220S

PLUG: ML-251-031-335-410S

RECEPTACLE: ML-261-031-445-220S

XX-XXX-XXX-XXX-XXXX-XXX

PLUG

RECEPTACLE

SERIES	
MK .050" Rugged Metal PC Board Mount Connector	MK .050" Rugged Metal PC Board Mount Connector
ML .050" Rugged Plastic PC Board Mount Connector (MK & ML mate with MK, ML, MM, MN receptacles)	ML .050" Rugged Plastic PC Board Mount Connector (MK & ML mate with MK, ML, MM, MN plugs)

BODY	
2 2-Row (Sizes 9 thru 37)	2 2-Row (Sizes 9 thru 37)
3 3-Row (Size 51 & 69***)	3 3-Row (Size 51 & 69***)
4 4-Row (Size 100)	4 4-Row (Size 100)

BODY STYLE: 5 Plug, right angle, narrow footprint, w/ mtg holes	BODY STYLE: 6 Receptacle, right angle, narrow footprint, w/ mtg holes
--	--

BODY MATERIAL: 1 Polyphenylene Sulfide (ML only)	BODY MATERIAL: 1 Polyphenylene Sulfide (ML only)
2 Electroless nickel shell w/ PPS insulator	2 Electroless nickel shell w/ PPS insulator
3 Electrodeposited cadmium shell w/ PPS insulator <input checked="" type="checkbox"/>	3 Electrodeposited cadmium shell w/ PPS insulator <input checked="" type="checkbox"/>
4 Hard anodized black shell w/ PPS insulator	4 Hard anodized black shell w/ PPS insulator
5 Stainless steel shell w/ PPS insulator	5 Stainless steel shell w/ PPS insulator

SIZE	
XXX 009, 015, 021, 025, 031, 037, 051, 069***, 100	XXX 009, 015, 021, 025, 031, 037, 051, 069***, 100

CONTACTS	
TYPE CONTACTS/TERMINATIONS: 32 Pin, right angle, PCB leads, .109"	TYPE CONTACTS/TERMINATIONS: 43 Socket, right angle, PCB leads, .109"
33 Pin, right angle, PCB leads, .140"	44 Socket, right angle, PCB leads, .140"
34 Pin, right angle, PCB leads, .172"	45 Socket, right angle, PCB leads, .172"

PLATING OPTIONS: 3 50 μ" Au contacts: Au terminations	PLATING OPTIONS: 3 50 μ" Au contacts: Au terminations
5 50 μ" Au contacts: Sn/Pb alloy terminations <input checked="" type="checkbox"/>	5 50 μ" Au contacts: Sn/Pb alloy terminations <input checked="" type="checkbox"/>
7 50 μ" Au contacts: SAC305 terminations	7 50 μ" Au contacts: SAC305 terminations

HARDWARE	
STYLE OF HARDWARE: 00 None	STYLE OF HARDWARE: 00 None
22 Two fixed jacknut assemblies (62*)	22 Two fixed jacknut assemblies (62*)
41 Two turning jackscrews, allen head, retaining ring**** (81*)	41 Two turning jackscrews, allen head, retaining ring**** (81*)

POLARIZATION / WIRING: 0R Reversed body polarization	POLARIZATION / WIRING: 0R Reversed body polarization
0S Standard body polarization	0S Standard body polarization

OPTIONS	
94P Mil-Spec footprint (size 100 only) Standard body polarization	900 Interfacial sealing gasket
0B7 Threaded inserts, standard body polarization	0B7 Threaded inserts and interfacial sealing gasket, standard body polarization
0BJ Mil-Spec footprint (size 100 only) with threaded inserts, standard body polarization	

* = Use numbers in parenthesis when ordering size 100.

*** = 69 position connectors are available in metal only.

**** = Connector body has no mounting holes.

= Option not RoHS compliant



Right Angle Boardmount Low Profile (Narrow Footprint)

.050"

9 thru 51 Contacts

MS, MR

MS-253-037-325-220S (PLUG)

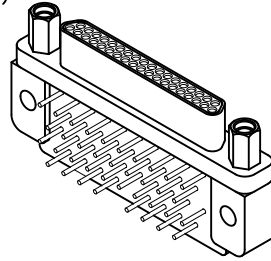

MS-263-037-435-220S (RCPT)

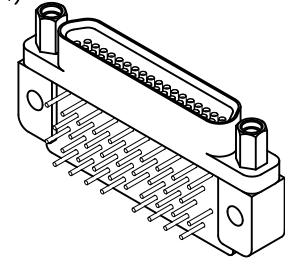

MATING MATRIX	
CONNECTOR	MATES WITH
MS-25...	MP, MQ, MR, MS receptacles
MR-25...	MP, MQ, MR, MS receptacles
MS-26..	MP, MQ, MR, MS plugs
MR-26..	MP, MQ, MR, MS plugs

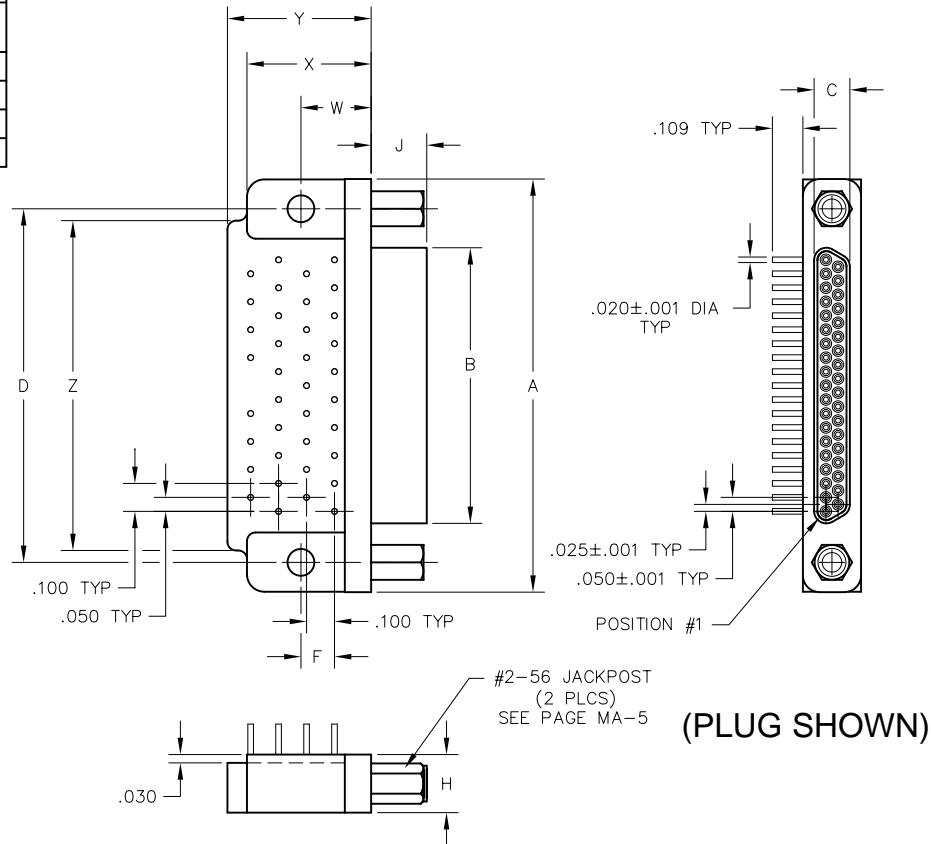

DIMENSIONS																		
SIZE	CONTACT ROWS	A	B		C		D	F	H	J		W	X MAX	Y MAX	Z	HARDWARE	MOUNTING HOLE	
			PLUG MAX	RCPT MAX	PLUG MAX	RCPT MAX				PLUG	RCPT							
9	2	.778	.292	.378	.134	.218	.565	.120	.208	.199	.180	.250	.420	.420	.775	#2-56 UNC THD	#2-56 DIA OR #2-56 UNC THREADED INSERT	
15		.928	.442	.528			.715											1.075
21		1.078	.592	.678			.865											1.175
25		1.178	.692	.778			.965											1.275
31		1.328	.842	.928			1.115											1.375
37		1.478	.992	1.078			1.265											1.475
51	3	1.428	.942	1.028	.177	.260	1.215	.150	.250	.300	.425	.650	1.220					

PLUG: MS-253-037-325-220S
RECEPTACLE: MS-263-037-435-220S
 XX-XXX-XXX-XXX-XXXX-XXX
 | | | | |
 BODY CONTACTS OPTIONS
 SERIES SIZE HARDWARE

PLUG

SERIES

MS .050" Low Profile Metal PC Board Mount Connector
 MR .050" Low Profile Plastic PC Board Mount Connector
 (MS & MR mate with MP, MQ, MR, MS, receptacles)

BODY

- 2 2-Row (Sizes 9 thru 37)
- 3 3-Row (Size 51)
- BODY STYLE:
- 5 Plug, right angle, narrow footprint, w/ mounting holes
- BODY MATERIAL:
- 1 Polyphenylene Sulfide (MR only)
- 2 Electroless nickel shell w/ PPS insulator
- 3 Electrodeposited cadmium shell w/ PPS insulator
- 4 Hard anodized black shell w/ PPS insulator

SIZE

XXX 009, 015, 021, 025, 031, 037, 051

CONTACTS

- TYPE CONTACTS/TERMINATIONS:
- 32 Pin, right angle, PCB leads, .109"
 - 33 Pin, right angle, PCB leads, .140"
 - 34 Pin, right angle, PCB leads, .172"
- PLATING OPTIONS:
- 3 50 μ" Au contacts; Au terminations
 - 5 50 μ" Au contacts; Sn/Pb alloy terminations
 - 7 50 μ" Au contacts; SAC305 terminations

HARDWARE

- STYLE OF HARDWARE:
- 00 None
 - 22 Two fixed jacknuts
 - 41 Two turning jackscrews, allen head, retaining ring*
 - 99 Keying hardware, see options below (Body material 2, 3 and 4 only)
- POLARIZATION / WIRING:
- 0R Reversed body polarization
 - 0S Standard body polarization

OPTIONS

- KPXX Two fixed jacknuts
- 905 Threaded inserts

NOTES

See page MA-6 for keying options
 * = Connector body has no mounting holes.
 = Option not RoHS compliant

RECEPTACLE

SERIES

MS .050" Low Profile Metal PC Board Mount Connector
 MR .050" Low Profile Plastic PC Board Mount Connector
 (MS & MR mate with MP, MQ, MR, MS plugs)

BODY

- 2 2-Row (Sizes 9 thru 37)
- 3 3-Row (Size 51)
- BODY STYLE:
- 6 Receptacle, right angle, narrow footprint, w/ mounting holes
- BODY MATERIAL:
- 1 Polyphenylene Sulfide (MR only)
- 2 Electroless nickel shell w/ PPS insulator
- 3 Electrodeposited cadmium shell w/ PPS insulator
- 4 Hard anodized black shell w/ PPS insulator

SIZE

XXX 009, 015, 021, 025, 031, 037, 051

CONTACTS

- TYPE CONTACTS/TERMINATIONS:
- 43 Socket, right angle, PCB leads, .109"
 - 44 Socket, right angle, PCB leads, .140"
 - 45 Socket, right angle, PCB leads, .172"
- PLATING OPTIONS:
- 3 50 μ" Au contacts; Au terminations
 - 5 50 μ" Au contacts; Sn/Pb alloy terminations
 - 7 50, u" Au contacts; SAC305 terminations

HARDWARE

- STYLE OF HARDWARE:
- 00 None
 - 22 Two fixed jacknuts
 - 41 Two turning jackscrews, allen head, retaining ring*
 - 99 Keying hardware, see options below (Body material 2, 3 and 4 only)
- POLARIZATION / WIRING:
- 0R Reversed body polarization
 - 0S Standard body polarization

OPTIONS

- KPXX Two fixed jacknuts
- 905 Threaded inserts

NOTES

See page MA-6 for keying options
 * = Connector body has no mounting holes.
 = Option not RoHS compliant



Right Angle Boardmount Low Profile (Blind Clearance Cut)

.050"
9 thru 51 Contacts

MS

MATING MATRIX	
CONNECTOR	MATES WITH
MS-2T...	MP, MQ, MR, MS receptacles
MS-2V..	MP, MQ, MR, MS plugs

MS-2T3-037-325-220S
(PLUG)

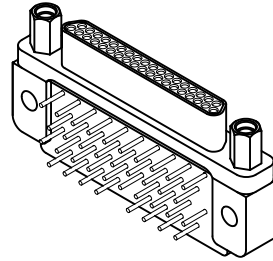

MS-2V3-037-435-220S
(RCPT)

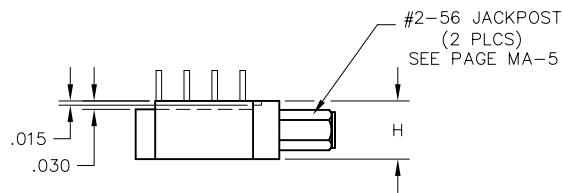
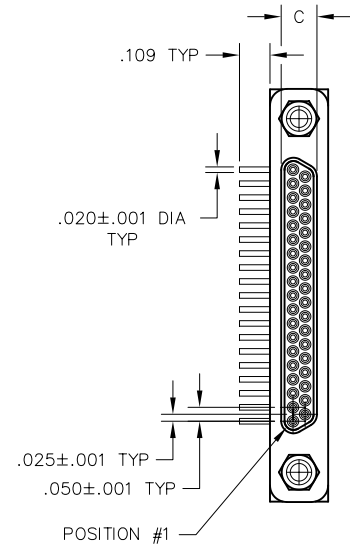
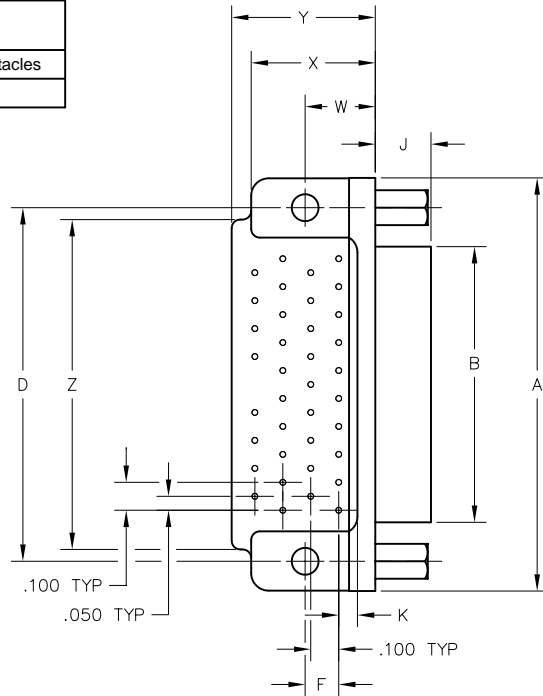
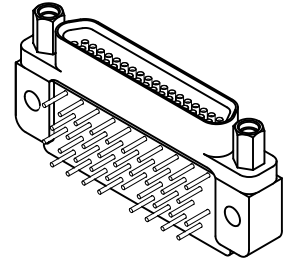

(PLUG SHOWN)

SIZE	CONTACT ROWS	DIMENSIONS																HARDWARE	MOUNTING HOLE
		B			C		D	F	H	J		K	W	X MAX	Y MAX	Z			
		PLUG MAX	RCPT MAX	PLUG MAX	RCPT MAX	PLUG				RCPT									
9	2	.778	.292	.378	.134	.218	.565	.020	.208	.199	.180	.067	.250	.420	.420	.775	#2-56 UNC THD	.096 DIA OR #2-56 UNC THREADED INSERT	
15		.928	.442	.528			.715												1.075
21		1.078	.592	.678			.865												1.175
25		1.178	.692	.778			.965												1.080
31		1.328	.842	.928			1.115												1.180
37		1.478	.992	1.078			1.265												1.180
51	3	1.428	.942	1.028	.177	.260	1.215	.150	.250	.087	.300	.425	.650	1.220					

PLUG: MS-2T3-037-325-220S
RECEPTACLE: MS-2V3-037-435-220S
 XX-XXX-XXX-XXX-XXXX-XXX
 | | | |
 BODY CONTACTS OPTIONS
 SERIES SIZE HARDWARE

PLUG

SERIES

MS .050" Low Profile Metal PC Board Mount Connector
 (MS mates with MP, MQ, MR, MS, receptacles)

BODY

- 2 2-Row (Sizes 9 thru 37)
- 3 3-Row (Size 51)
- BODY STYLE: Blind Cut
- T Plug, right angle, narrow footprint, w/ mounting holes
- BODY MATERIAL:
- 2 Electroless nickel shell w/ PPS insulator
- 3 Electrodeposited cadmium shell w/ PPS insulator
- 4 Hard anodized black shell w/ PPS insulator

SIZE

XXX 009, 015, 021, 025, 031, 037, 051

CONTACTS

- TYPE CONTACTS/TERMINATIONS:
- 32 Pin, right angle, PCB leads, .109"
 - 33 Pin, right angle, PCB leads, .140"
 - 34 Pin, right angle, PCB leads, .172"
- PLATING OPTIONS:
- 3 50 μ" Au contacts: Au terminations
 - 5 50 μ" Au contacts; Sn/Pb alloy terminations
 - 7 50 μ" Au contacts; SAC305 terminations

HARDWARE

- STYLE OF HARDWARE:
- 00 None
 - 22 Two fixed jacknuts
 - 41 Two turning jackscrews, allen head, retaining ring*
 - 99 Keying hardware, see options below

- POLARIZATION / WIRING:
- 0R Reversed body polarization
 - 0S Standard body polarization

OPTIONS

- KPXX Two fixed jacknuts
- 905 Threaded inserts

NOTES

- See page MA-6 for keying options
- * = Connector body has no mounting holes.
- = Option not RoHS compliant

RECEPTACLE

SERIES

MS .050" Low Profile Metal PC Board Mount Connector
 (MS mates with MP, MQ, MR, MS plugs)

BODY

- 2 2-Row (Sizes 9 thru 37)
- 3 3-Row (Size 51)
- BODY STYLE: Blind Cut
- V Receptacle, right angle, narrow footprint, w/ mounting holes
- BODY MATERIAL:
- 2 Electroless nickel shell w/ PPS insulator
- 3 Electrodeposited cadmium shell w/ PPS insulator
- 4 Hard anodized black shell w/ PPS insulator

SIZE

XXX 009, 015, 021, 025, 031, 037, 051

CONTACTS

- TYPE CONTACTS/TERMINATIONS:
- 43 Socket, right angle, PCB leads, .109"
 - 44 Socket, right angle, PCB leads, .140"
 - 45 Socket, right angle, PCB leads, .172"
- PLATING OPTIONS:
- 3 50 μ" Au contacts: Au terminations
 - 5 50 μ" Au contacts; Sn/Pb alloy terminations
 - 7 50, u" Au contacts; SAC305 terminations

HARDWARE

- STYLE OF HARDWARE:
- 00 None
 - 22 Two fixed jacknuts
 - 41 Two turning jackscrews, allen head, retaining ring*
 - 99 Keying hardware, see options below

- POLARIZATION / WIRING:
- 0R Reversed body polarization
 - 0S Standard body polarization

OPTIONS

- KPXX Two fixed jacknuts
- 905 Threaded inserts

NOTES

- See page MA-6 for keying options
- * = Connector body has no mounting holes.
- = Option not RoHS compliant



Board (Narrow Footprint) to Flex Cable

.050"

9 thru 51 Contacts

Low Profile Board Mount

MS, MR

Flex Cable

MS, MR

MS-253-037-335-410S
(METAL)

MR-251-037-335-410S
(PLASTIC)

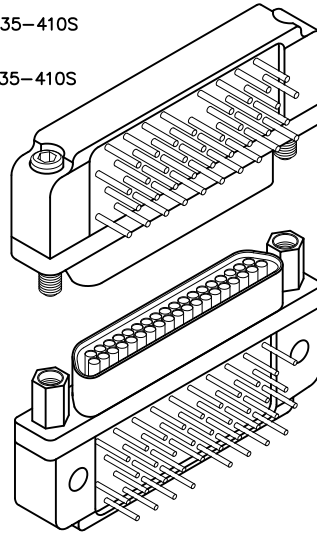

MS-263-037-445-220S
(METAL)

MR-261-037-445-220S
(PLASTIC)

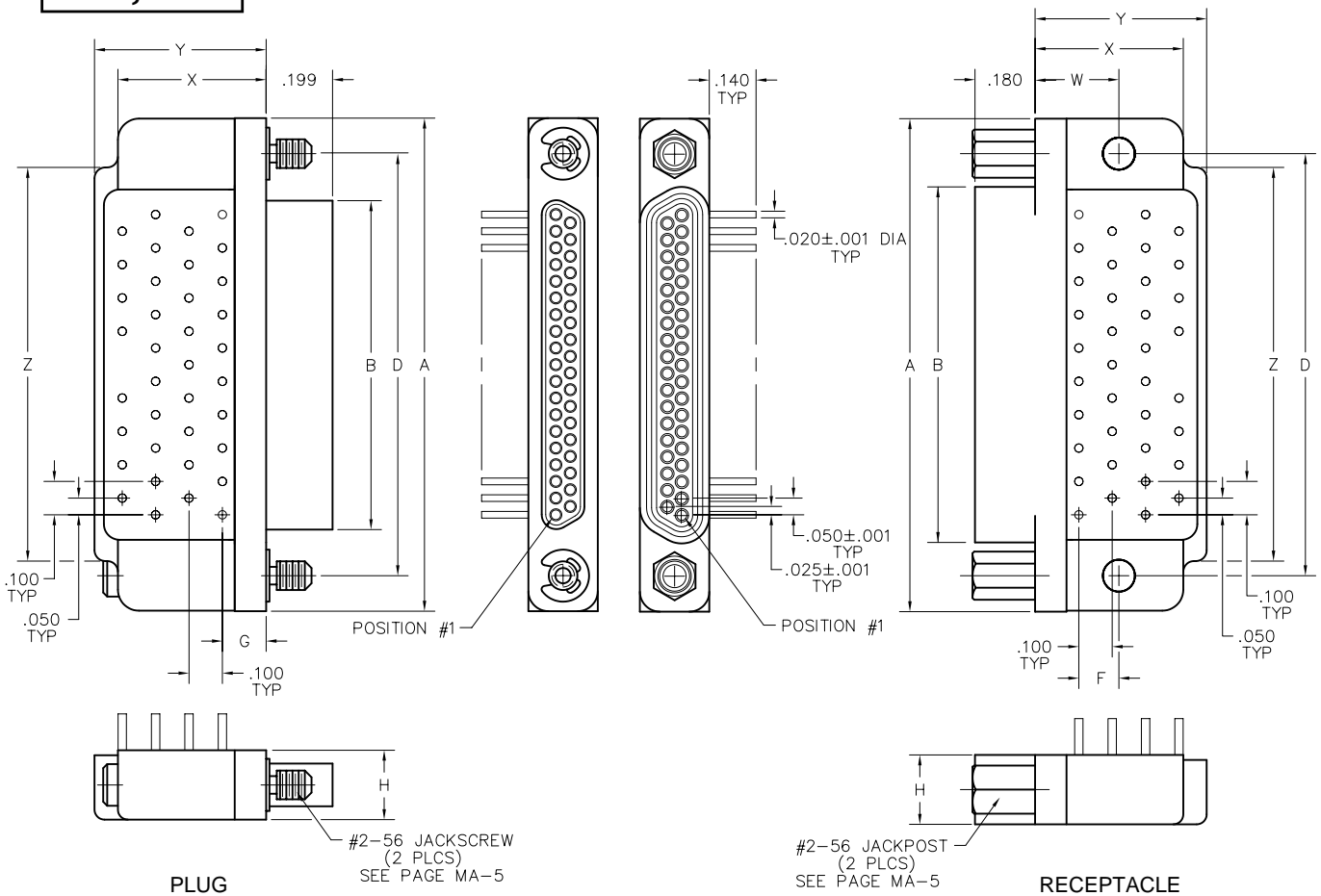

SIZE	CONTACT ROWS	DIMENSIONS											HARDWARE	MOUNTING HOLE																						
		A	B		D	F	G	H	W	X MAX	Y MAX	Z																								
			PLUG MAX	RCPT MAX																																
9	2	.778	.292	.378	.565	.020	.230	.208	.250	.420	.420	.775	#2-56 UNC THD	.096 DIA THRU																						
15		.928	.442	.528	.715	.120	.130					.208			.250	.420	.420	.925																		
21		1.078	.592	.678	.865													.120	.130	.208	.250	.420	.420	1.075												
25		1.178	.692	.778	.965																			.120	.130	.208	.250	.420	.420	1.175						
31		1.328	.842	.928	1.115																									.120	.130	.208	.250	.420	.420	1.080
37		1.478	.992	1.078	1.265																															.120
51	3	1.428	.942	1.028	1.215	.150	.150	.250	.300	.425	.650	1.220	#2-56 UNC THD	.096 DIA THRU																						

PLUG: MS-253-037-335-410S
RECEPTACLE: MS-263-037-445-220S
PLUG: MR-251-037-335-410S
RECEPTACLE: MR-261-037-445-220S
 XX-XXX-XXX-XXX-XXXX

PLUG		RECEPTACLE	
SERIES			
MS .050" Low Profile Metal PC Board Mount Connector	MS .050" Low Profile Metal PC Board Mount Connector	MR .050" Low Profile Plastic PC Board Mount Connector	MR .050" Low Profile Plastic PC Board Mount Connector
(MS & MR mate with MP, MQ, MR, MS receptacles)		(MS & MR mate with MP, MQ, MR, MS plugs)	
BODY			
2 2-Row (Sizes 9 thru 37)	2 2-Row (Sizes 9 thru 37)	3 3-Row (Size 51)	3 3-Row (Size 51)
BODY STYLE: 5 Plug, right angle, narrow footprint, w/ mtg holes		BODY STYLE: 6 Receptacle, right angle, narrow footprint, w/ mtg holes	
BODY MATERIAL: 1 Polyphenylene Sulfide (ML only) 2 Electroless nickel shell w/ PPS insulator 3 Electrodeposited cadmium shell w/ PPS insulator <input checked="" type="checkbox"/> 4 Hard anodized black shell w/ PPS insulator		BODY MATERIAL: 1 Polyphenylene Sulfide (ML only) 2 Electroless nickel shell w/ PPS insulator 3 Electrodeposited cadmium shell w/ PPS insulator <input checked="" type="checkbox"/> 4 Hard anodized black shell w/ PPS insulator	
SIZE			
XXX 009, 015, 021, 025, 031, 037, 051		XXX 009, 015, 021, 025, 031, 037, 051	
CONTACTS			
TYPE CONTACTS/TERMINATIONS: 32 Pin, right angle, PCB leads, .109" 33 Pin, right angle, PCB leads, .140" 34 Pin, right angle, PCB leads, .172"		TYPE CONTACTS/TERMINATIONS: 43 Socket, right angle, PCB leads, .109" 44 Socket, right angle, PCB leads, .140" 45 Socket, right angle, PCB leads, .172"	
PLATING OPTIONS: 3 50 μ" Au contacts: Au terminations 5 50 μ" Au contacts: Sn/Pb alloy terminations <input checked="" type="checkbox"/> 7 50 μ" Au contacts: SAC305 terminations		PLATING OPTIONS: 3 50 μ" Au contacts: Au terminations 5 50 μ" Au contacts: Sn/Pb alloy terminations <input checked="" type="checkbox"/> 7 50 μ" Au contacts: SAC305 terminations	
HARDWARE			
STYLE OF HARDWARE: 00 None 22 Two fixed jacknut assemblies 41 Two turning jackscrews, allen head, retaining ring		STYLE OF HARDWARE: 00 None 22 Two fixed jacknut assemblies 41 Two turning jackscrews, allen head, retaining ring	
POLARIZATION / WIRING: 0R Reversed body polarization 0S Standard body polarization		POLARIZATION / WIRING: 0R Reversed body polarization 0S Standard body polarization	

= Option not RoHS compliant



Recommended PC Board Layout

Right Angle, Narrow Footprint
Standard Polarization



CONNECTOR MATING FACE

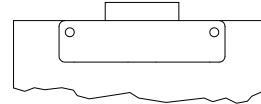

PC BOARD LAYOUT
COMPONENT SIDE

PLUG
PC BOARD LAYOUT
COMPONENT SIDE

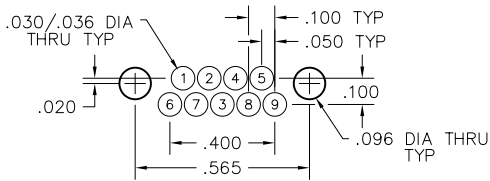

CONNECTOR
MATING FACE*
(RECEPTACLE)

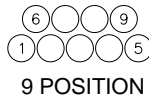

9 POSITION

RECEPTACLE
PC BOARD LAYOUT
COMPONENT SIDE

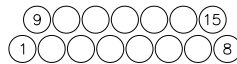
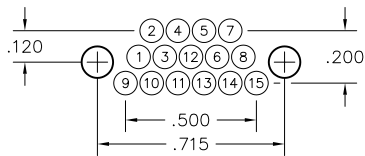
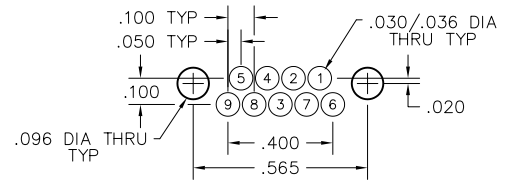

15 POSITION

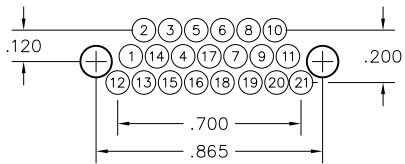
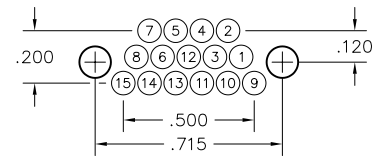

21 POSITION

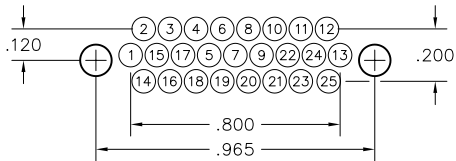
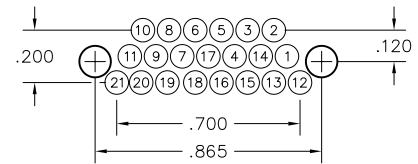

25 POSITION

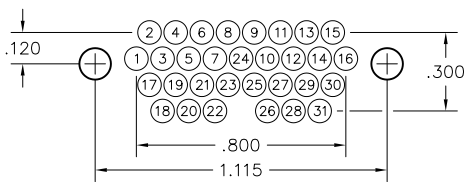
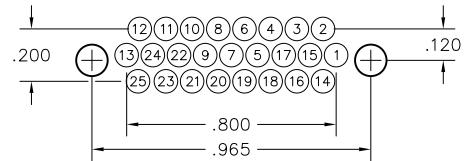

31 POSITION

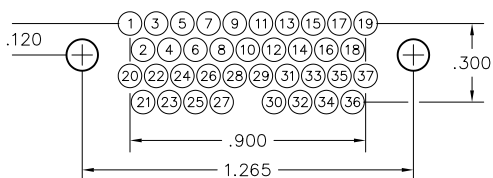
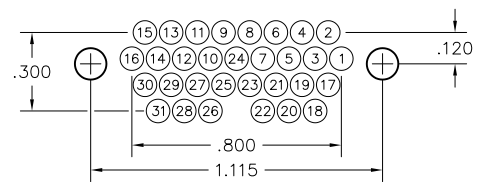

37 POSITION

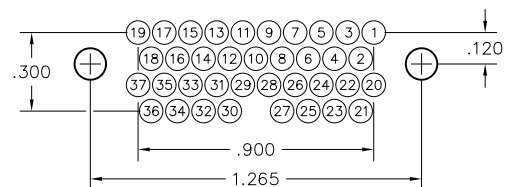

Recommended PC Board Layout

Right Angle, Narrow Footprint
Standard Polarization

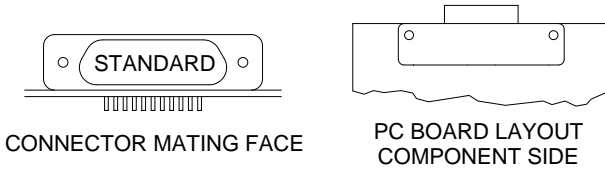

PLUG
PC BOARD LAYOUT
COMPONENT SIDE

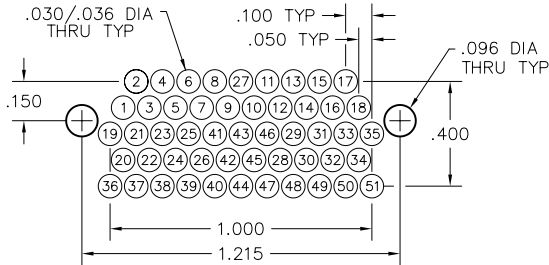

CONNECTOR MATING FACE* (RECEPTACLE)

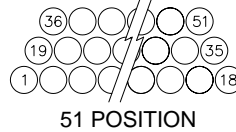

RECEPTACLE
PC BOARD LAYOUT
COMPONENT SIDE

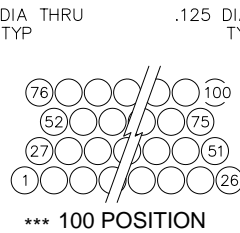
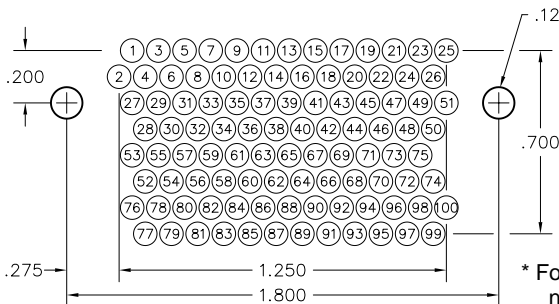
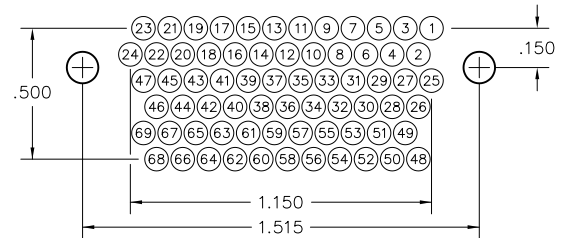
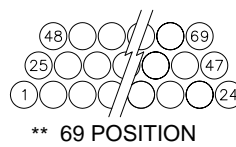
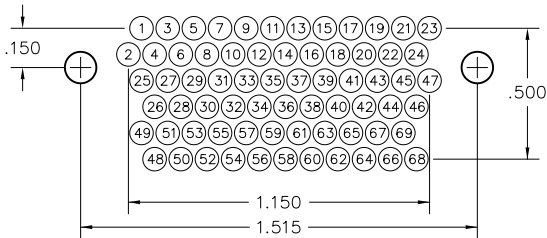
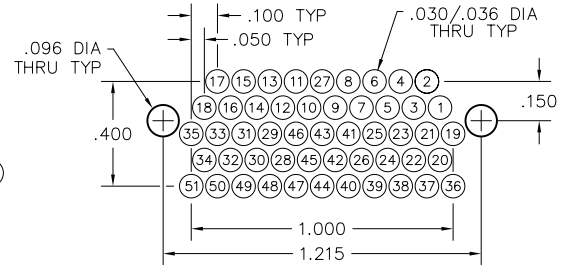

* For pin (plug) connectors, the contact numbers are reversed left to right.

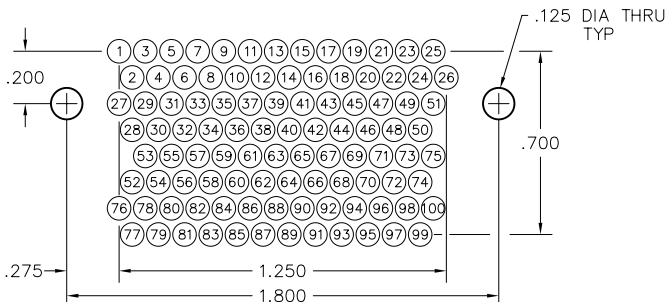
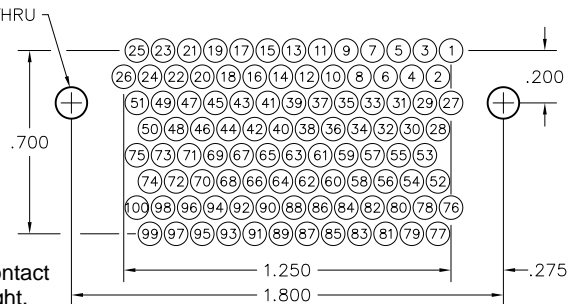

Mil-Spec Footprint

For Mil-Spec footprint, use "Option" -94P

- ** = 69 and 100 positions not available in low profile (MS, MR)
- *** = 100 position not available in thru-cut body style (R, S)



Recommended PC Board Layout

Right Angle, Narrow Footprint
Reverse Polarization



CONNECTOR MATING FACE

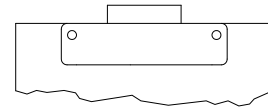

PC BOARD LAYOUT
COMPONENT SIDE

PLUG
PC BOARD LAYOUT
COMPONENT SIDE

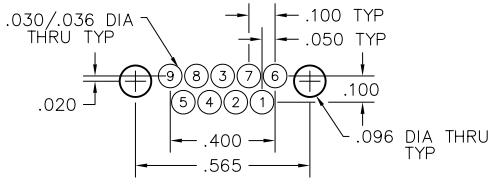

CONNECTOR
MATING FACE*
(RECEPTACLE)



9 POSITION

RECEPTACLE
PC BOARD LAYOUT
COMPONENT SIDE

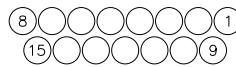
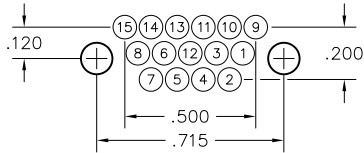
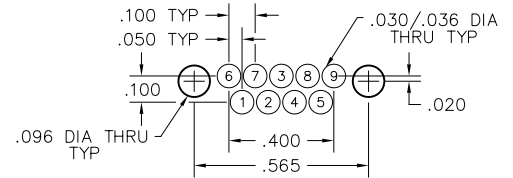

15 POSITION

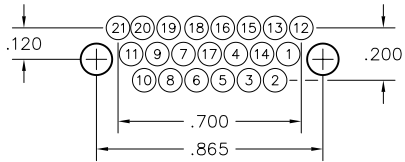
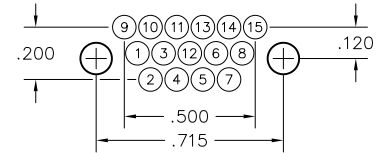

21 POSITION

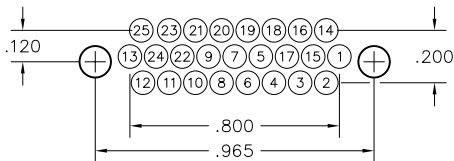
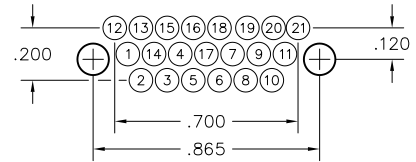

25 POSITION

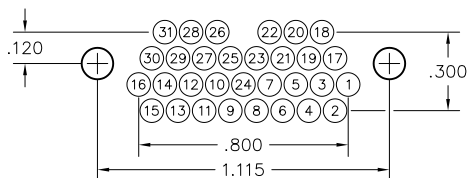
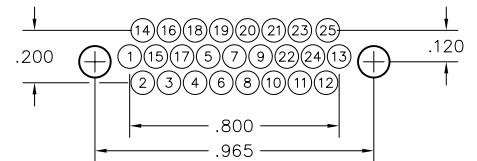

31 POSITION

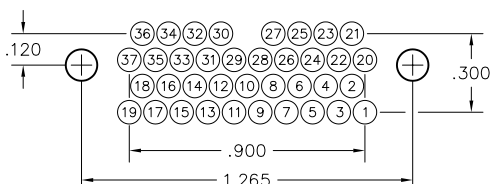
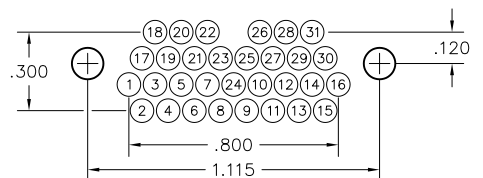

37 POSITION

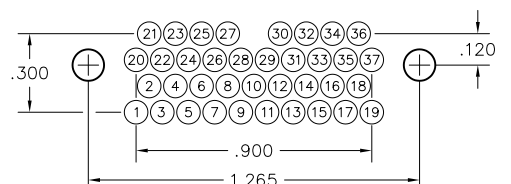

Recommended PC Board Layout

Right Angle, Narrow Footprint
Reverse Polarization

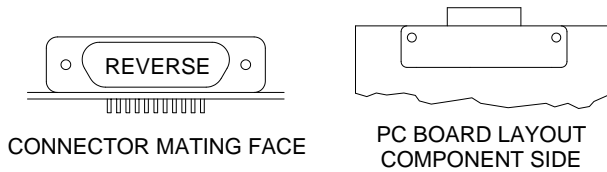

PLUG
PC BOARD LAYOUT
COMPONENT SIDE

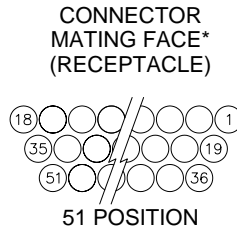
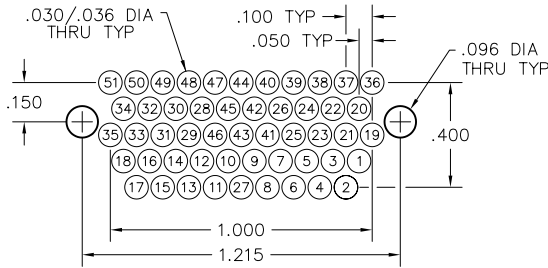

RECEPTACLE
PC BOARD LAYOUT
COMPONENT SIDE

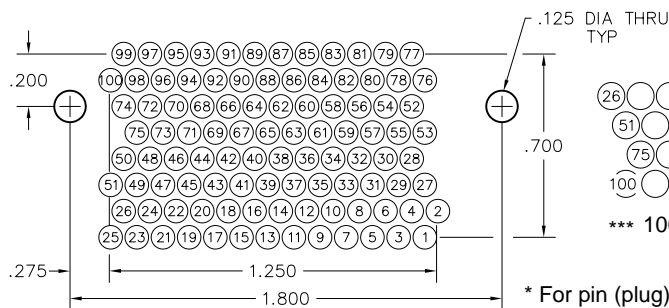
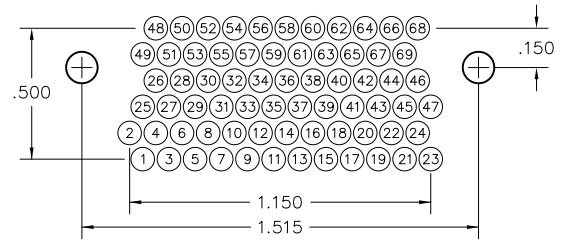
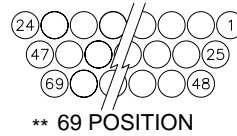
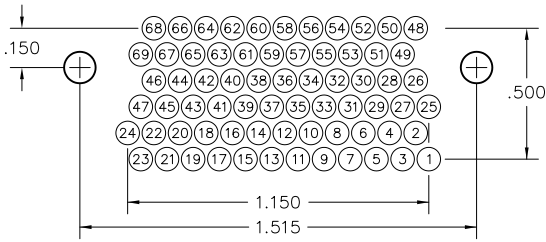
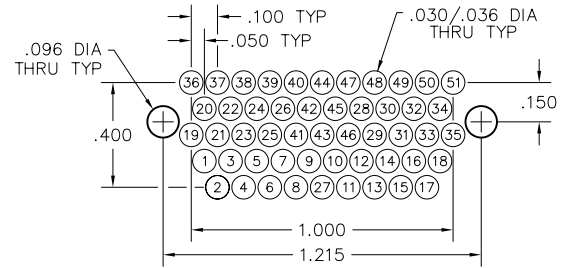

*** 100 POSITION

* For pin (plug) connectors, the contact numbers are reversed left to right.

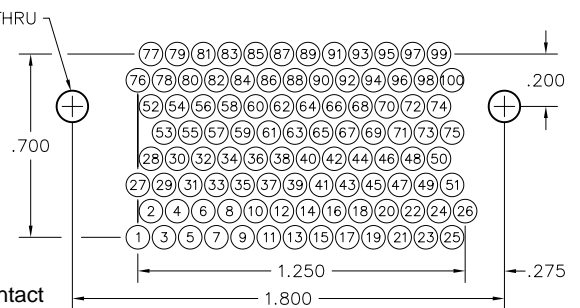

** = 69 and 100 positions not available in low profile (MS, MR)

*** = 100 position not available in thru-cut body style (R, S)

Right Angle Boardmount (Compressed Footprint)

.050"
9 thru 100 Contacts

MK

MK-2P2-031-A35-220S
(PLUG)

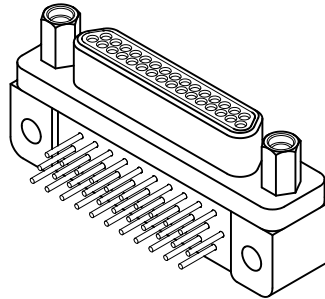

MK-2Q2-031-B45-220S
(RECEPTACLE)

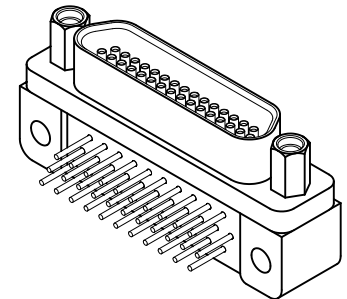

MATING MATRIX	
CONNECTOR	MATES WITH
MK-2P...	MK, ML, MM, MN receptacles
MK-2Q...	MK, ML, MM, MN plugs

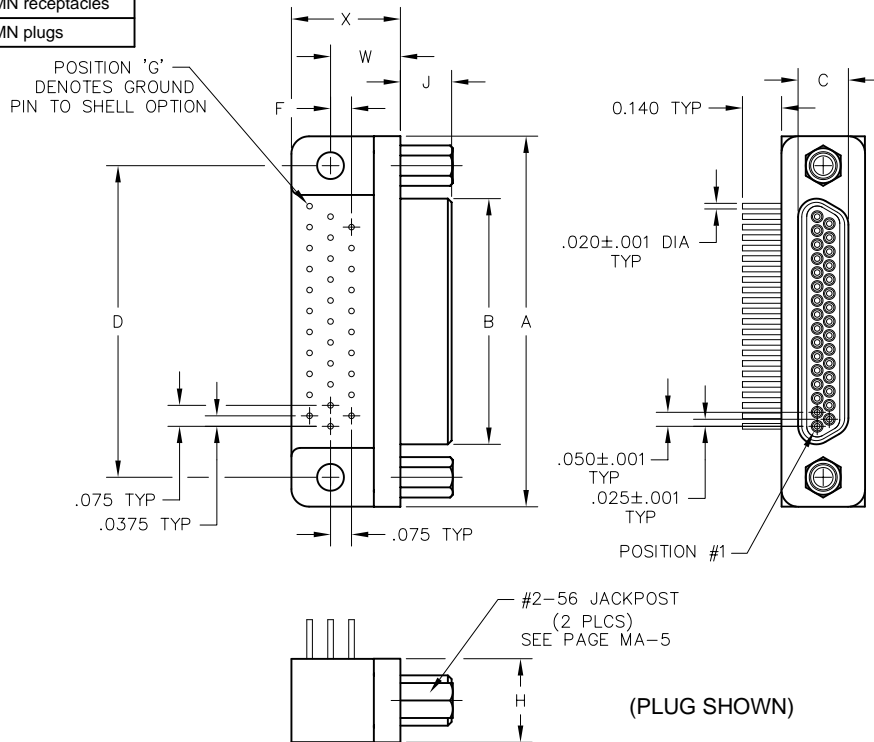

SIZE	CONTACT ROWS	A	B		C		D	F	H	J		W	X MAX	HARDWARE	MOUNTING HOLE
			PLUG MAX	RCPT MAX	PLUG MAX	RCPT MAX				PLUG	RCPT				
9	2	.775	.334	.400	.185	.251	.565	.0375	.183	.195	.250	.400	#2-56 UNC THD	#2-56 UNC THREADED INSERT	
15		.925	.484	.550			.715								
21		1.075	.634	.700			.865								
25		1.175	.734	.800			.965								
31		1.325	.884	.950			1.115								
37	1.475	1.034	1.100	1.265											
51	3	1.425	.984	1.050	.228	.294	1.215	.1125	.341	.300	.490	#4-40 UNC THD	#4-40 UNC THREADED INSERT		
69		1.725	1.284	1.350			1.515								
100	4	2.160	1.384	1.508	.271	.394	1.800	.1875	.384	.400	.660	#4-40 UNC THD	#4-40 UNC THREADED INSERT		

PLUG: MK-2P2-031-335-220S
RECEPTACLE: MK-2Q2-031-445-220S
XX-XXX-XXX-XXX-XXXX-XXX
 | | | |
 BODY CONTACTS OPTIONS
 SERIES SIZE HARDWARE

PLUG

SERIES

MK .050" Rugged Metal PC Board Mount Connector

BODY

- 2 2-Row (Sizes 9 thru 37)
 - 3 3-Row (Size 51 & 69)
 - 4 4-Row (Size 100)
- BODY STYLE:**
- P Plug, right angle, compressed footprint
- BODY MATERIAL:**
- 2 Electroless nickel shell w/ PPS insulator
 - 3 Electrodeposited cadmium shell w/ PPS insulator
 - 4 Hard anodized black shell w/ PPS insulator
 - 5 Stainless steel shell w/ PPS insulator

SIZE

XXX 009, 015, 021, 025, 031, 037, 051, 069, 100

CONTACTS

TYPE CONTACTS/TERMINATIONS:

- 32 Pin, right angle, PCB leads, .109"
- 33 Pin, right angle, PCB leads, .140"
- 34 Pin, right angle, PCB leads, .172"
- A2 Pin, right angle, PCB leads, .109", w/ ground pin option
- A3 Pin, right angle, PCB leads, .140", w/ ground pin option
- A4 Pin, right angle, PCB leads, .172", w/ ground pin option

PLATING OPTIONS:

- 3 50 μ" Au contacts: Au terminations
- 5 50 μ" Au contacts: Sn/Pb alloy terminations
- 7 50 μ" Au contacts: SAC305 terminations

HARDWARE

STYLE OF HARDWARE:

- 00 None
- 22 Two fixed jacknuts (62*)
- 99 Keying hardware, see options below

POLARIZATION:

- 0S Standard body polarization

OPTIONS

- 0B7 Threaded inserts in mounting holes
- KPXX Two fixed jacknuts (KN*)

NOTES

See page MA-6 for keying options

* = Use numbers in parenthesis when ordering size 100.
 = Option not RoHS compliant

RECEPTACLE

SERIES

MK .050" Rugged Metal PC Board Mount Connector

BODY

- 2 2-Row (Sizes 9 thru 37)
 - 3 3-Row (Size 51 & 69)
 - 4 4-Row (Size 100)
- BODY STYLE:**
- Q Receptacle, right angle, compressed footprint
- BODY MATERIAL:**
- 2 Electroless nickel shell w/ PPS insulator
 - 3 Electrodeposited cadmium shell w/ PPS insulator
 - 4 Hard anodized black shell w/ PPS insulator
 - 5 Stainless steel shell w/ PPS insulator

SIZE

XXX 009, 015, 021, 025, 031, 037, 051, 069, 100

CONTACTS

TYPE CONTACTS/TERMINATIONS:

- 43 Socket, right angle, PCB leads, .109"
- 44 Socket, right angle, PCB leads, .140"
- 45 Socket, right angle, PCB leads, .172"
- B3 Socket, right angle, PCB leads, .109", w/ ground pin option
- B4 Socket, right angle, PCB leads, .140", w/ ground pin option
- B5 Socket, right angle, PCB leads, .172", w/ ground pin option

PLATING OPTIONS:

- 3 50 μ" Au contacts: Au terminations
- 5 50 μ" Au contacts: Sn/Pb alloy terminations
- 7 50 μ" Au contacts: SAC305 terminations

HARDWARE

STYLE OF HARDWARE:

- 00 None
- 22 Two fixed jacknuts (62*)
- 99 Keying hardware, see options below

POLARIZATION:

- 0S Standard body polarization

OPTIONS

- 900 Interfacial sealing gasket
- 0B7 Threaded inserts in mounting holes and interfacial sealing gasket
- KPXX Two fixed jacknuts (KN*) and interfacial sealing gasket

NOTES

See page MA-6 for keying options



Recommended PC Board Layout

Right Angle, Compressed Footprint
Standard Polarization

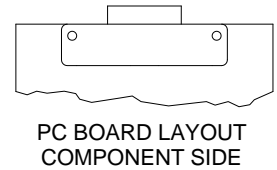
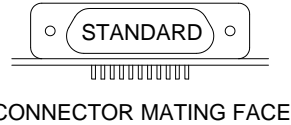

PLUG
PC BOARD LAYOUT COMPONENT SIDE

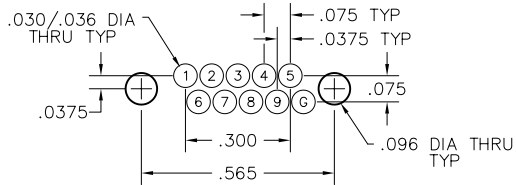

CONNECTOR MATING FACE* (RECEPTACLE)



RECEPTACLE
PC BOARD LAYOUT COMPONENT SIDE

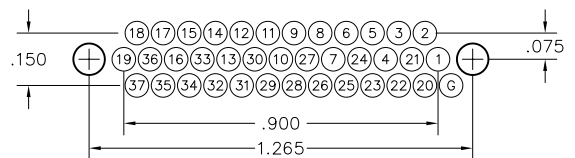
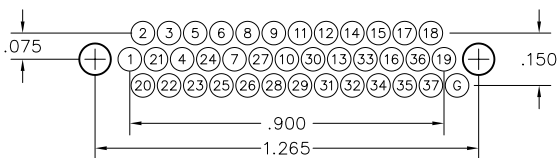
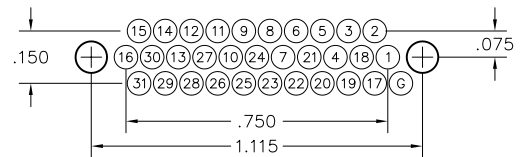
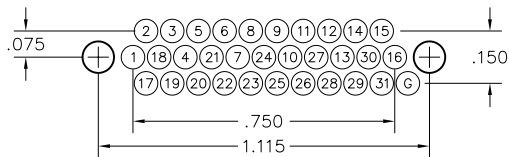
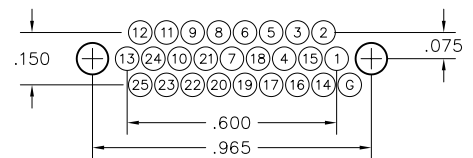
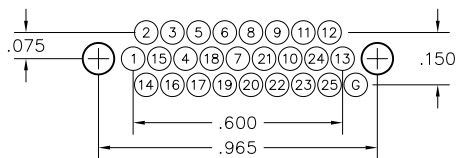
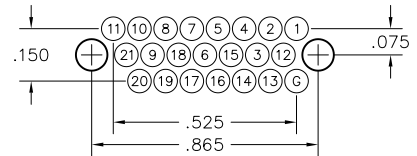
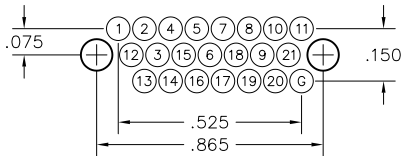
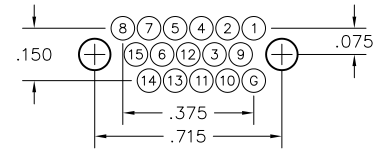
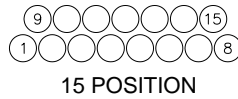
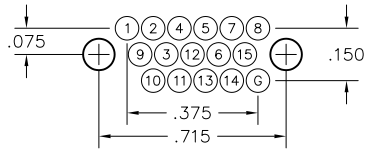
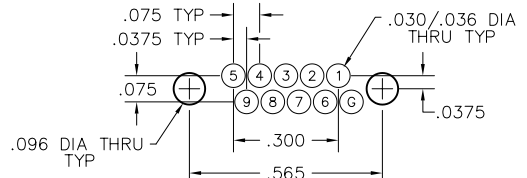

Recommended PC Board Layout

Right Angle, Compressed Footprint
Standard Polarization

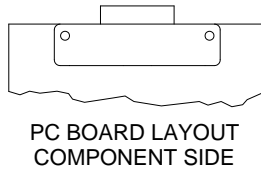
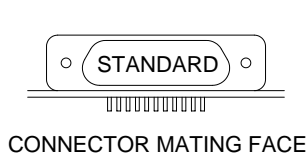

PLUG
PC BOARD LAYOUT
COMPONENT SIDE

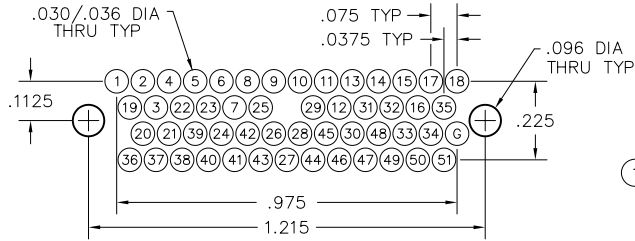

CONNECTOR MATING FACE* (RECEPTACLE)

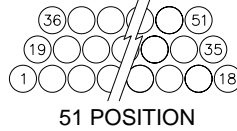

RECEPTACLE
PC BOARD LAYOUT
COMPONENT SIDE

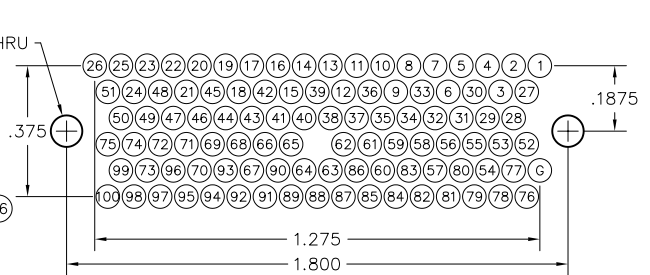
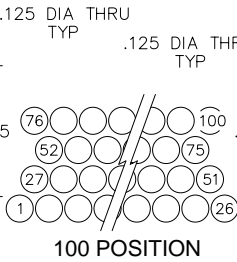
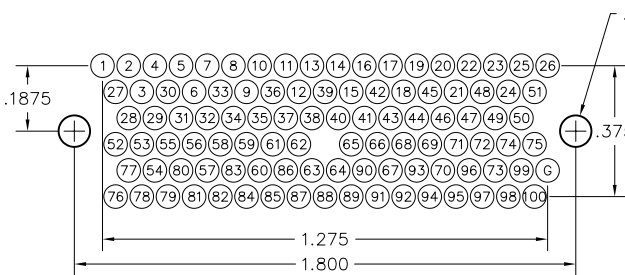
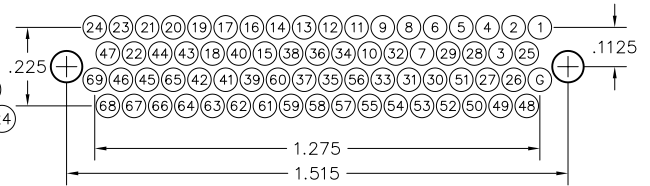
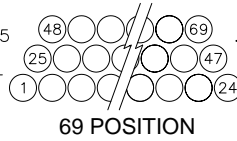
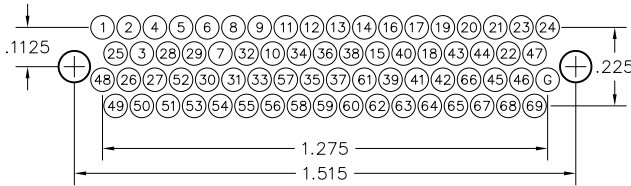
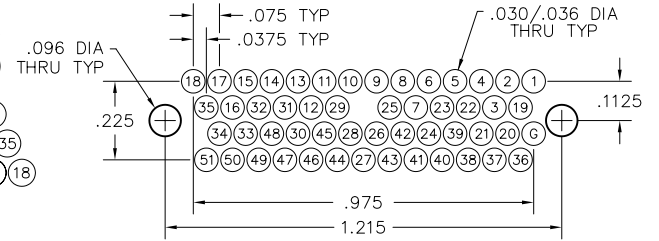

* For pin (plug) connectors, the contact numbers are reversed left to right.



MK-283-025-435-220R
(METAL)

ML-281-025-435-220R
(PLASTIC)

Board (Standard Footprint) to Cable

.050"

9 thru 100 Contacts

Rugged Board Mount

MK, ML

Rugged Cable

MM, MN

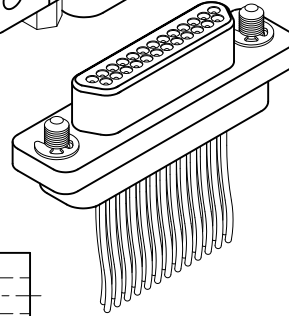
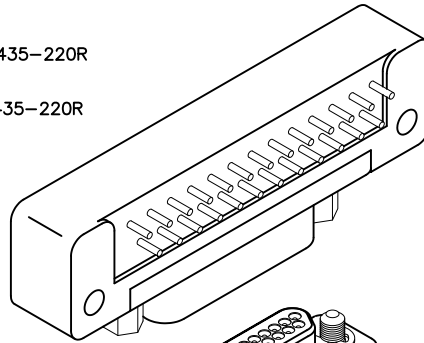

MM-213-025-161-41WQ
(METAL)

MN-211-025-161-41WQ
(PLASTIC)

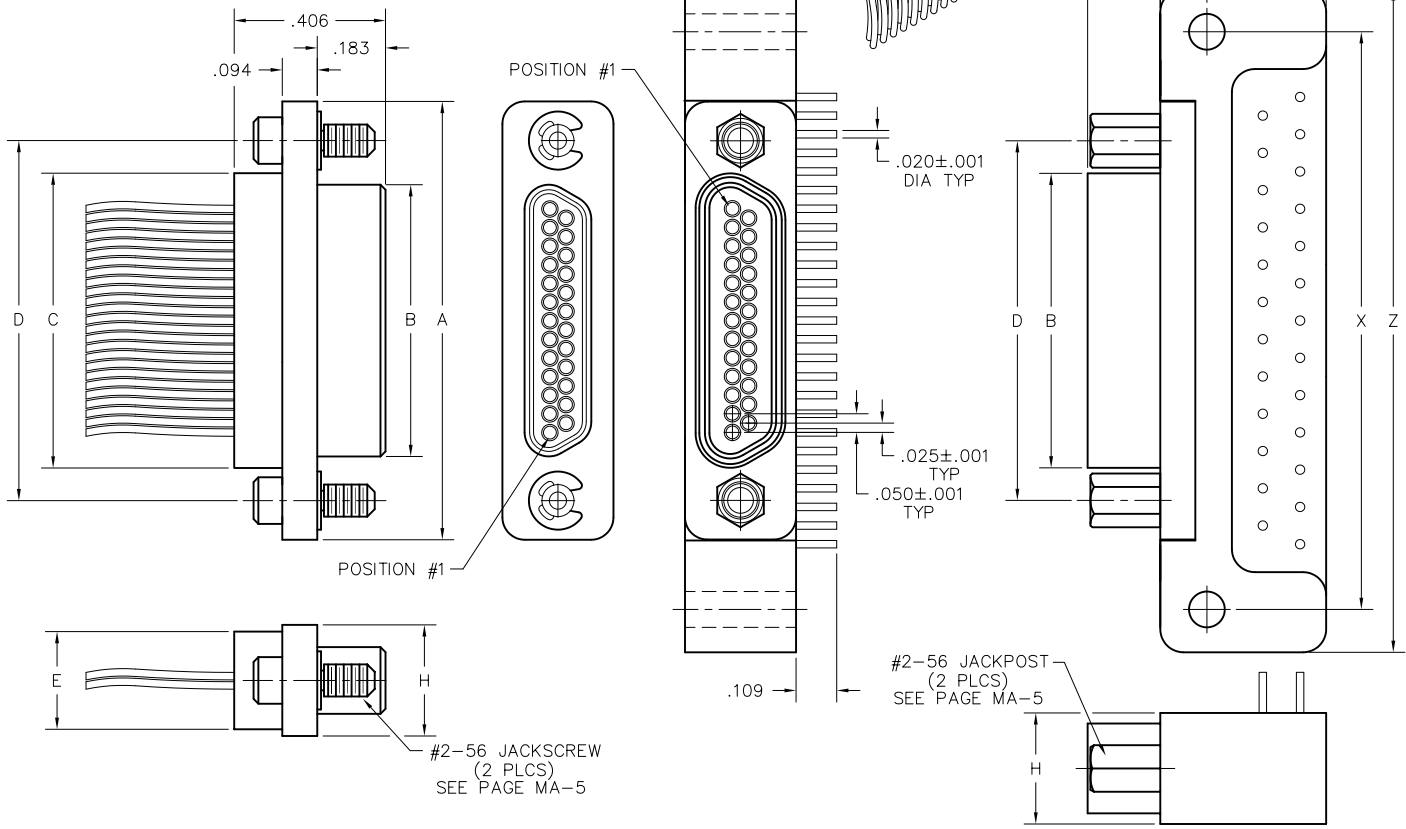

SIZE	CONTACT ROWS	DIMENSIONS											HARDWARE	MOUNTING HOLE
		A	B		C	D	E	H	X	Y	Z			
			PLUG MAX	RCPT MAX								POTTING WELL MAX		
9	2	.775	.334	.400	.390	.565	.270	.298	1.150	.455	1.390	#2-56 UNC THD	.096 DIA OR #2-56 UNC THREADED INSERT	
15		.925	.484	.550	.540	.715			1.300		1.540			
21		1.075	.634	.700	.690	.865			1.450		1.690			
25		1.175	.734	.800	.790	.965			1.550		1.790			
31		1.325	.884	.950	.940	1.115			1.800		2.040			
37		1.475	1.034	1.100	1.090	1.265			2.100		2.340			
51	3	1.425	.984	1.050	1.040	1.215	.310	.341	1.600	.565	1.875	#4-40 UNC THD	.125 DIA OR #4-40 UNC THREADED INSERT	
100	4	2.160	1.384	1.508	1.432	1.800	.360	.384	2.500	.665**	2.780			

* = .225 FOR "-05K" AND "0BJ" SPECIAL CODES (MIL-SPEC FOOTPRINT FOR 100 POSITION ONLY)
 ** = .765 MAX FOR "-05K" AND "0BJ" SPECIAL CODES (MIL-SPEC FOOTPRINT FOR 100 POSITION ONLY)

PLUG: MM-213-025-161-41WQ
RECEPTACLE: MK-283-025-435-220R
PLUG: MN-211-025-161-41WQ
RECEPTACLE: ML-281-025-435-220R
 XX-XXX-XXX-XXX-XXXX-XXX

PLUG

RECEPTACLE

SERIES

MM .050" Rugged Metal I/O Connector MN .050" Rugged Plastic I/O Connector (MM & MN mate with MK, ML, MM, MN receptacles)	MK .050" Rugged Metal PC Board Mount Connector ML .050" Rugged Plastic PC Board Mount Connector (MK & ML mate with MK, ML, MM, MN plugs)
--	--

BODY

2 2-Row (Sizes 9 thru 37) 3 3-Row (Size 51) 4 4-Row (Size 100)	2 2-Row (Sizes 9 thru 37) 3 3-Row (Size 51) 4 4-Row (Size 100)
BODY STYLE: 1 Plug, straight, with ears	BODY STYLE: 8 Receptacle, right angle, standard footprint, w/ mtg holes
BODY MATERIAL: 1 Polyphenylene Sulfide (MN only) 2 Polyphenylene Sulfide with electroless nickel shell 3 Polyphenylene Sulfide with electrodeposited cadmium shell <input checked="" type="checkbox"/> 4 Polyphenylene Sulfide with hard anodized black shell 5 Polyphenylene Sulfide with stainless steel shell	BODY MATERIAL: 1 Polyphenylene Sulfide (ML only) 2 Polyphenylene Sulfide with electroless nickel shell 3 Polyphenylene Sulfide with electrodeposited cadmium shell <input checked="" type="checkbox"/> 4 Polyphenylene Sulfide with hard anodized black shell 5 Polyphenylene Sulfide with stainless steel shell

SIZE

XXX 009, 015, 021, 025, 031, 037, 051, 100 | XXX 009, 015, 021, 025, 031, 037, 051, 100

CONTACTS

TYPE CONTACTS/TERMINATIONS: 11 Pin, straight, solder cup 14 Pin, straight, .500" pigtails (.018 dia) 15 Pin, straight, 1.000" pigtails (.018 dia) 16 Pin, straight, crimped wire	TYPE CONTACTS/TERMINATIONS: 43 Socket, right angle, PCB leads, .109" 44 Socket, right angle, PCB leads, .140" 45 Socket, right angle, PCB leads, .172"
PLATING OPTIONS: 1 50 μ" Au contacts (crimp wire) 3 50 μ" Au contacts: 10 μ" Au terminations (solder cup, pigtail) 5 50 μ" Au contacts; Sn/Pb alloy terminations (pigtail) <input checked="" type="checkbox"/> 7 50 μ" Au contacts; SAC305 terminations (pigtail)	PLATING OPTIONS: 3 50 μ" Au contacts: 10 μ" Au terminations 5 50 μ" Au contacts; Sn/Pb alloy terminations <input checked="" type="checkbox"/> 7 50 μ" Au contacts; SAC305 terminations

HARDWARE

STYLE OF HARDWARE: 00 None 22 Two fixed jacknut assemblies (62*) 41 Two turning jackscrews, allen head, retaining ring (81*) 42 Two long turning jackscrews, allen head, retaining ring (82*) 43 Two turning jackscrews, slot head, retaining ring (83*) 44 Two long turning jackscrews, slot head, retaining ring (84*) 45 Two turning jackscrews, allen head, captivated** (85*) 99 Keying hardware, see options below (Body material 2, 3 and 4 only)	STYLE OF HARDWARE: 00 None 22 Two fixed jacknut assemblies (62*) 99 Keying hardware, see options below (Body material 2, 3 and 4 only)
---	--

POLARIZATION / WIRING: 00 None XX For wiring codes, see page MA-3 & MA-4	POLARIZATION / WIRING OR Reversed body polarization
---	---

OPTIONS

KSXX Two turning jackscrews. See page MA-6 for keying options (KJ*)	KPXX Two fixed jacknuts and interfacial sealing gasket. See page MA-6 for keying options (KN*) 900 Interfacial sealing gasket 05K Mil-Spec footprint (size 100 only) 0B7 Threaded inserts and interfacial sealing gasket 0BJ Mil-Spec footprint (size 100 only) with threaded inserts and interfacial sealing gasket
---	--

* = Use numbers or letters in parenthesis when ordering size 100.

** = Captive hardware is factory installed and non-removable.

= Option not RoHS compliant



Board (Standard Footprint) to Cable

.050"

9 thru 100 Contacts

Rugged Board Mount

MK, ML

Rugged Cable

MM, MN

MK-273-025-325-220R
(METAL)

ML-271-025-325-220R
(PLASTIC)

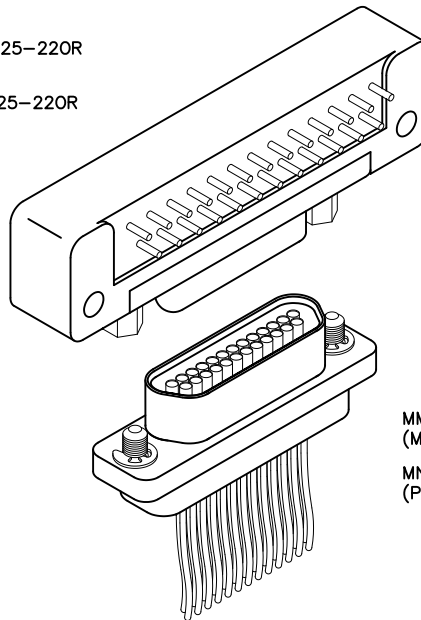

MM-223-025-261-41WQ
(METAL)

MN-221-025-261-41WQ
(PLASTIC)

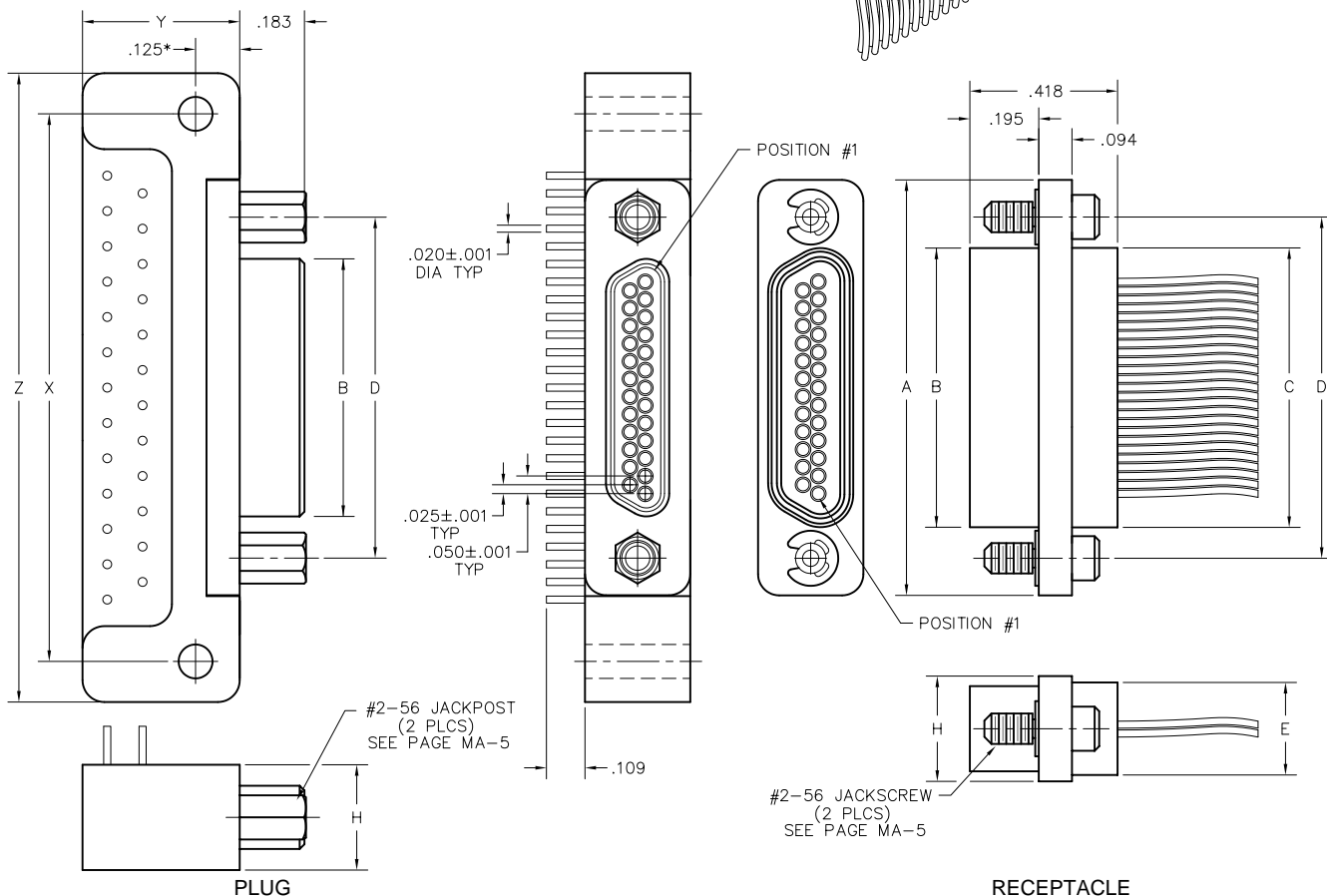

DIMENSIONS													
SIZE	CONTACT ROWS	A	B		C	D	E	H	X	Y MAX	Z MAX	HARDWARE	MOUNTING HOLE
			PLUG MAX	RCPT MAX									
9	2	.775	.334	.400	.390	.565	.270	.298	1.150	.455	1.390	#2-56 UNC THD	.096 DIA OR #2-56 UNC THREADED INSERT
15		.925	.484	.550	.540	.715			1.300		1.540		
21		1.075	.634	.700	.690	.865			1.450		1.690		
25		1.175	.734	.800	.790	.965			1.550		1.790		
31		1.325	.884	.950	.940	1.115			1.800		2.040		
37		1.475	1.034	1.100	1.090	1.265			2.100		2.340		
51	3	1.425	.984	1.050	1.040	1.215	.310	.341	1.600	.565	1.875	#4-40 UNC THD	.125 DIA OR #4-40 UNC THREADED INSERT
100	4	2.160	1.384	1.508	1.432	1.800	.360	.384	2.500	.665**	2.780		

* = .225 FOR ".05K" AND "0BJ" SPECIAL CODES (MIL-SPEC FOOTPRINT FOR 100 POSITION ONLY)
 ** = .765 MAX FOR ".05K" AND "0BJ" SPECIAL CODES (MIL-SPEC FOOTPRINT FOR 100 POSITION ONLY)

PLUG: MK-273-025-325-220R
RECEPTACLE: MM-223-025-261-41WQ
PLUG: ML-271-025-325-220R
RECEPTACLE: MN-221-025-261-41WQ
 XX-XXX-XXX-XXX-XXXX-XXX

PLUG		RECEPTACLE	
SERIES			
MK .050" Rugged Metal PC Board Mount Connector	MM .050" Rugged Metal I/O Connector	ML .050" Rugged Plastic PC Board Mount Connector	MN .050" Rugged Plastic I/O Connector
(MK & ML mate with MK, ML, MM, MN receptacles)		(MM & MN mate with MK, ML, MM, MN plugs)	
BODY			
2 2-Row (Sizes 9 thru 37)	2 2-Row (Sizes 9 thru 37)	3 3-Row (Size 51)	3 3-Row (Size 51)
4 4-Row (Size 100)	4 4-Row (Size 100)		
BODY STYLE: 7 Plug, right angle, standard footprint, w/ mtg holes		BODY STYLE: 2 Receptacle, straight, with ears	
BODY MATERIAL:		BODY MATERIAL:	
1 Polyphenylene Sulfide (ML only)	1 Polyphenylene Sulfide (MN only)	2 Polyphenylene Sulfide with electroless nickel shell	2 Polyphenylene Sulfide with electroless nickel shell
3 Polyphenylene Sulfide with electrodeposited cadmium shell <input checked="" type="checkbox"/>	3 Polyphenylene Sulfide with electrodeposited cadmium shell <input checked="" type="checkbox"/>	4 Polyphenylene Sulfide with hard anodized black shell	4 Polyphenylene Sulfide with hard anodized black shell
5 Polyphenylene Sulfide with stainless steel shell	5 Polyphenylene Sulfide with stainless steel shell		
SIZE			
XXX 009, 015, 021, 025, 031, 037, 051, 100		XXX 009, 015, 021, 025, 031, 037, 051, 100	
CONTACTS			
TYPE CONTACTS/TERMINATIONS:		TYPE CONTACTS/TERMINATIONS:	
32 Pin, right angle, PCB leads, .109"	21 Socket, straight, solder cup	24 Socket, straight, .500" pigtails (.018 dia)	25 Socket, straight, 1.000" pigtails (.018 dia)
33 Pin, right angle, PCB leads, .140"	26 Socket, straight, crimped wire		
34 Pin, right angle, PCB leads, .172"			
PLATING OPTIONS:		PLATING OPTIONS:	
3 50 μ" Au contacts; 10 μ" Au terminations	1 50 μ" Au contacts (crimp wire)	3 50 μ" Au contacts; 10 μ" Au terminations (solder cup, pigtail)	5 50 μ" Au contacts; Sn/Pb alloy terminations (pigtail) <input checked="" type="checkbox"/>
5 50 μ" Au contacts; Sn/Pb alloy terminations <input checked="" type="checkbox"/>	7 50 μ" Au contacts; SAC305 terminations	7 50 μ" Au contacts; SAC305 terminations (pigtail)	
HARDWARE			
STYLE OF HARDWARE:		STYLE OF HARDWARE:	
00 None	00 None	22 Two fixed jacknut assemblies (62*)	41 Two turning jackscrews, allen head, retaining ring (81*)
22 Two fixed jacknut assemblies (62*)	42 Two long turning jackscrews, allen head, retaining ring (82*)	99 Keying hardware, see options below (Body material 2, 3 and 4 only)	43 Two turning jackscrews, slot head, retaining ring (83*)
	44 Two long turning jackscrews, slot head, retaining ring (84*)		45 Two turning jackscrews, allen head, captivated** (85*)
	99 Keying hardware, see options below (Body material 2, 3 and 4 only)		
POLARIZATION / WIRING:		POLARIZATION / WIRING	
0R Reversed body polarization	00 None	XX For wiring codes, see page MA-3 & MA-4	
	XX For wiring codes, see page MA-3 & MA-4		
OPTIONS			
KPXX Two fixed jacknuts. See page MA-6 for keying options (KN*)	KSXX Two turning jackscrews and interfacial sealing gasket. See page MA-6 for keying options (KJ*)	05K Mil-Spec footprint (size 100 only)	900 Interfacial sealing gasket
0B7 Threaded inserts		0BJ Mil-Spec footprint (size 100 only) with threaded inserts	

* = Use numbers or letters in parenthesis when ordering size 100.

** = Captive hardware is factory installed and non-removable.

= Option not RoHS compliant



Recommended PC Board Layout

Right Angle, Standard Footprint
Reverse Polarization



CONNECTOR MATING FACE

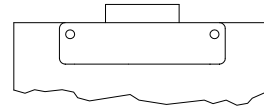

PC BOARD LAYOUT
COMPONENT SIDE

PLUG PC BOARD LAYOUT COMPONENT SIDE

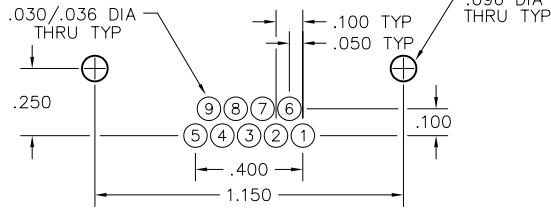

CONNECTOR MATING FACE (PLUG)

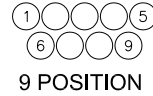

9 POSITION

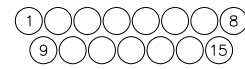
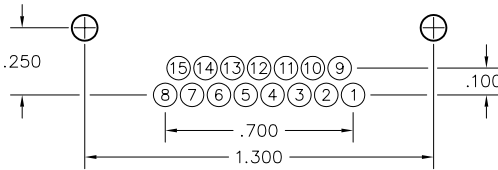

15 POSITION

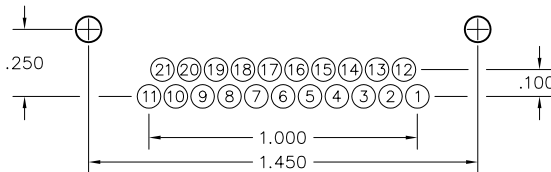

21 POSITION

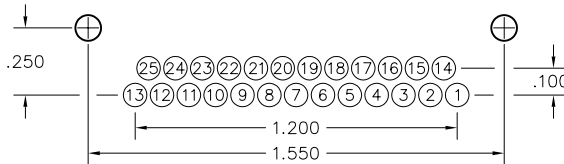

25 POSITION

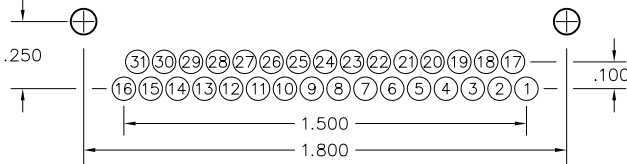

31 POSITION

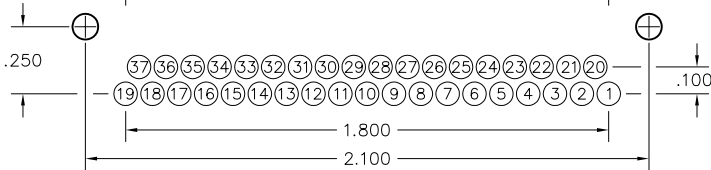

37 POSITION

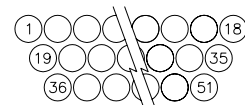
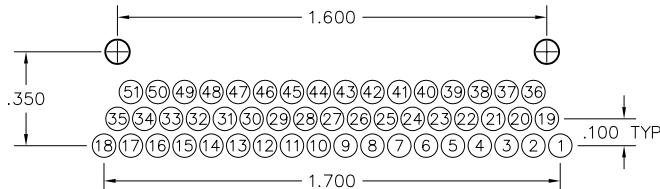

51 POSITION

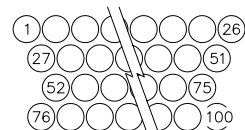
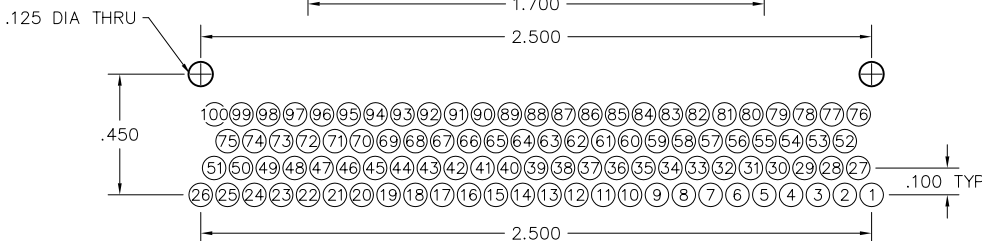

100 POSITION

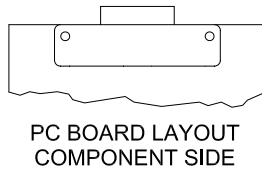
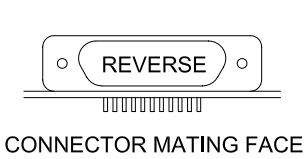

Recommended PC Board Layout

Right Angle, Standard Footprint
Reverse Polarization

CONNECTOR MATING FACE (RECEPTACLE)

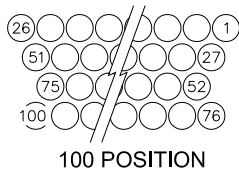
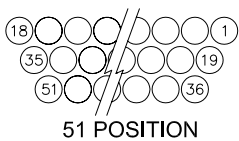
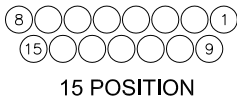
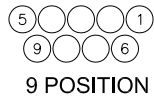

RECEPTACLE PC BOARD LAYOUT COMPONENT SIDE

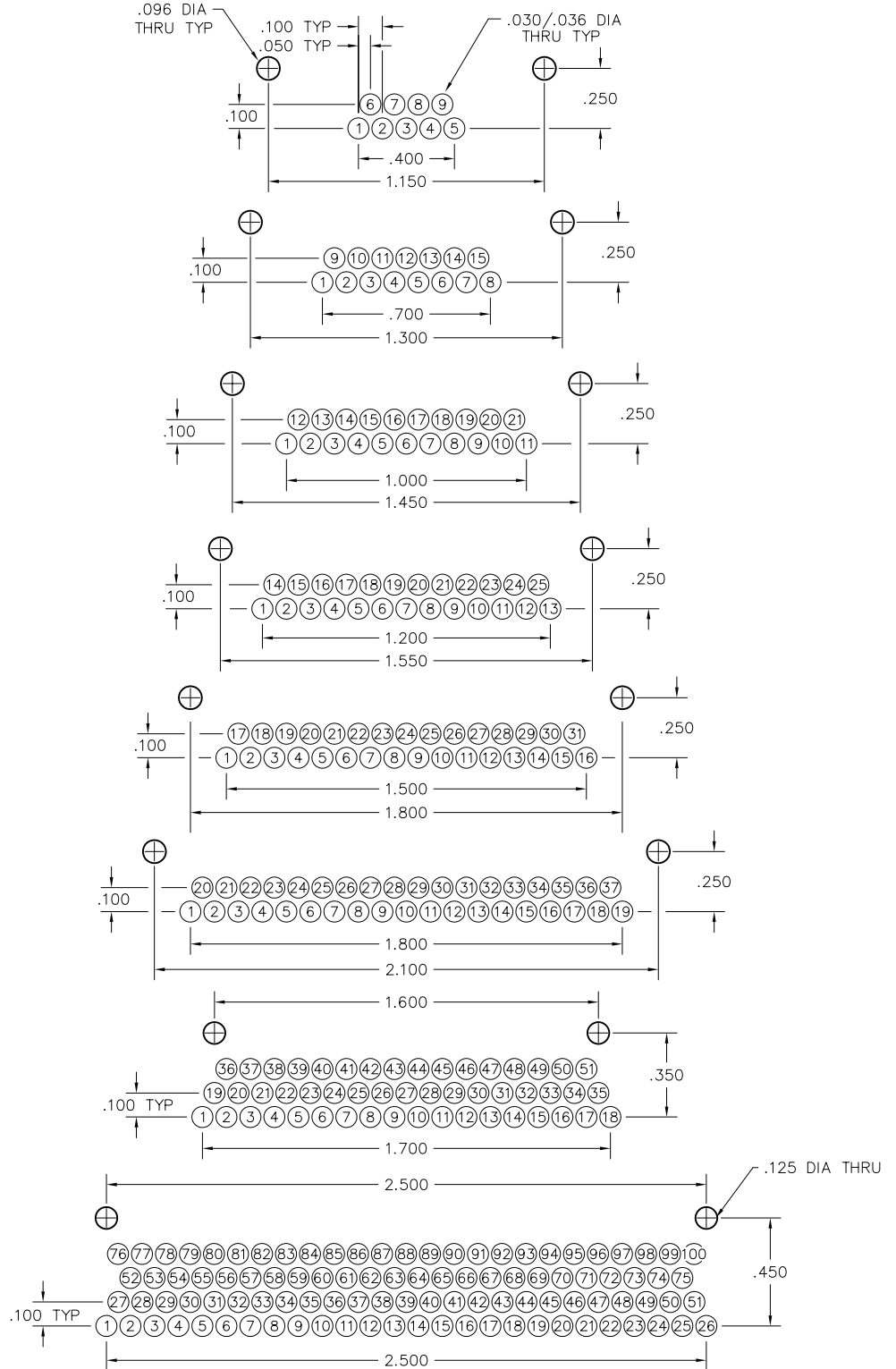



Cable to Board (Narrow Footprint)

.050"

9 thru 100 Contacts

Rugged Cable

MM, MN

Rugged Board Mount

MK, ML

MM-312-051-153-4400
(METAL)

MN-311-051-153-4400
(PLASTIC)

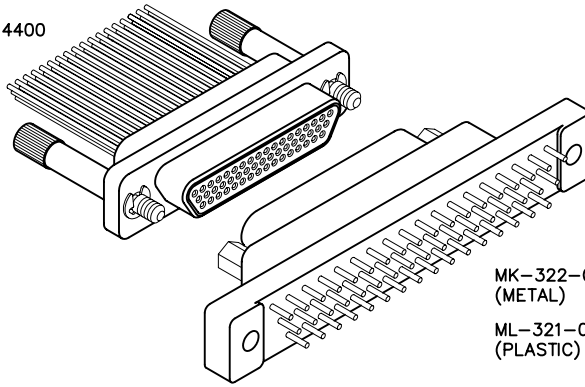

MK-322-051-235-2200
(METAL)

ML-321-051-235-2200
(PLASTIC)

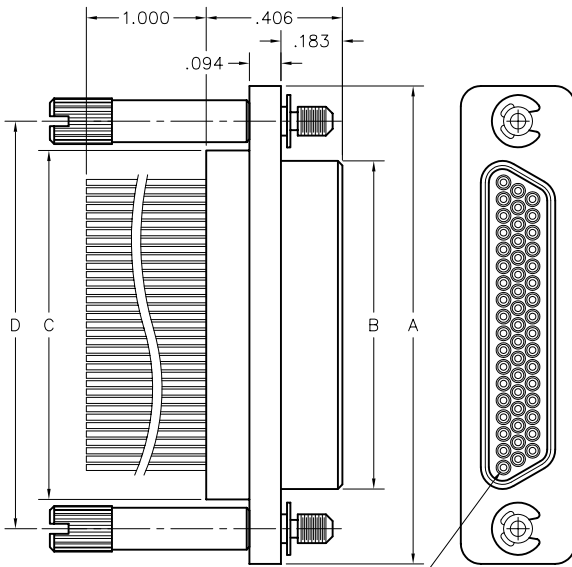

POSITION #1

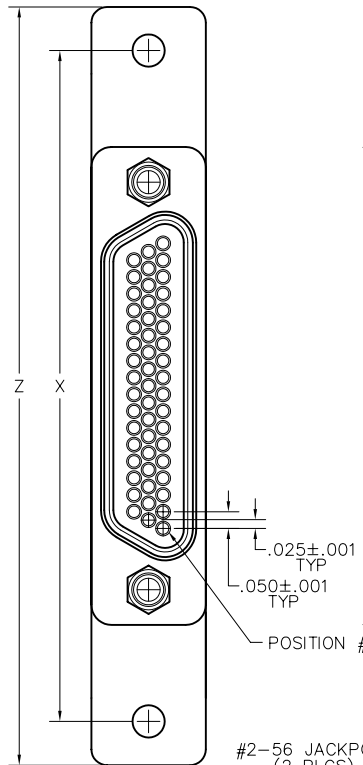

#2-56 JACKPOST
(2 PLCS)
SEE PAGE MA-5

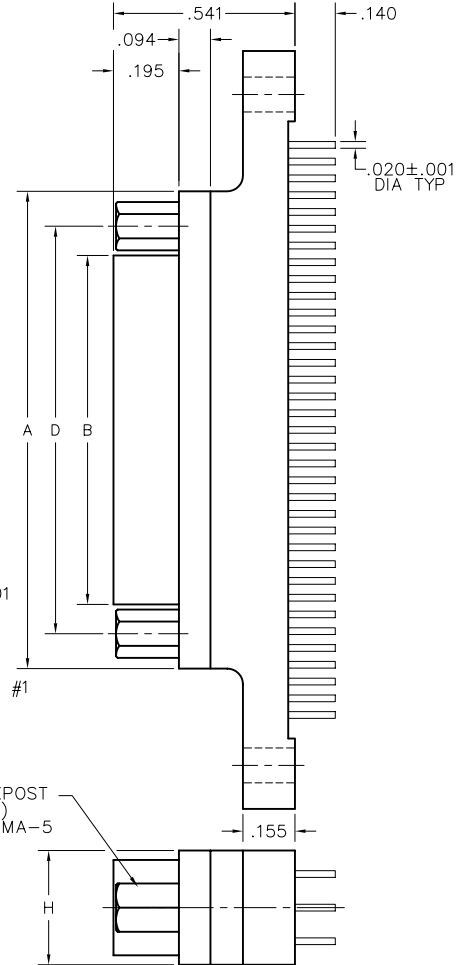

RECEPTACLE

PLUG

SIZE	CONTACT ROWS	DIMENSIONS										HARDWARE	MOUNTING HOLE
		A	B		C	D	E	H	X	Z			
			PLUG MAX	RCPT MAX							POTTING WELL MAX		
9	2	.775	.334	.400	.390	.565	.270	.298	1.150	1.390	#2-56 UNC THD (.092 DIA THRU)	.096 DIA OR #2-56 UNC THREADED INSERT	
15		.925	.484	.550	.540	.715			1.450	1.690			
21		1.075	.634	.700	.690	.865			1.500	1.740			
25		1.175	.734	.800	.790	.965			1.800	2.040			
31		1.325	.884	.950	.940	1.115			2.100	2.340			
37	3	1.475	1.034	1.100	1.090	1.265	.310	.341	2.000	2.270	#4-40 UNC THD (.147 DIA THRU)	.125 DIA OR #2-56 UNC THREADED INSERT	
51		1.425	.984	1.050	1.040	1.215			2.800	3.240			
100		4	2.160	1.384	1.508	1.432			1.800	3.600			4.080

PLUG: MM-312-051-153-4400

RECEPTACLE: MK-322-051-235-2200

PLUG: MN-311-051-153-4400

RECEPTACLE: ML-321-051-235-2200

XX-XXX-XXX-XXX-XXXX-XXX

PLUG

RECEPTACLE

SERIES	
MM .050" Rugged Metal I/O Connector	MK .050" Rugged Metal PC Board Mount Connector
MN .050" Rugged Plastic I/O Connector	ML .050" Rugged Plastic PC Board Mount Connector
(MM & MN mate with MK, ML, MM, MN receptacles)	
(MK & ML mate with MK, ML, MM, MN plugs)	

BODY	
2 2-Row (Sizes 9 thru 37)	2 2-Row (Sizes 9 thru 37)
3 3-Row (Size 51)	3 3-Row (Size 51)
4 4-Row (Size 100)	4 4-Row (Size 100)

BODY STYLE:	
1 Plug, straight, with ears	2 Receptacle, straight, narrow footprint, w/ mtg holes

BODY MATERIAL:	
1 Polyphenylene Sulfide (MN only)	1 Polyphenylene Sulfide (ML only)
2 Polyphenylene Sulfide with electroless nickel shell	2 Polyphenylene Sulfide with electroless nickel shell
3 Polyphenylene Sulfide with electrodeposited cadmium shell <input checked="" type="checkbox"/>	3 Polyphenylene Sulfide with electrodeposited cadmium shell <input checked="" type="checkbox"/>
4 Polyphenylene Sulfide with hard anodized black shell	4 Polyphenylene Sulfide with hard anodized black shell
5 Polyphenylene Sulfide with stainless steel shell	5 Polyphenylene Sulfide with stainless steel shell

SIZE	
XXX 009, 015, 021, 025, 031, 037, 051, 100	XXX 009, 015, 021, 025, 031, 037, 051, 100

CONTACTS	
TYPE CONTACTS/TERMINATIONS:	TYPE CONTACTS/TERMINATIONS:
11 Pin, straight, solder cup	22 Socket, straight, PCB leads, .109"
14 Pin, straight, .500" pigtails (.018 dia)	23 Socket, straight, PCB leads, .140"
15 Pin, straight, 1.000" pigtails (.018 dia)	24 Socket, straight, PCB leads, .172"
16 Pin, straight, crimped wire	

PLATING OPTIONS:	
1 50 μ" Au contacts (crimp wire)	3 50 μ" Au contacts; 10 μ" Au terminations
3 50 μ" Au contacts; 10 μ" Au terminations (solder cup, pigtail)	5 50 μ" Au contacts; Sn/Pb alloy terminations <input checked="" type="checkbox"/>
5 50 μ" Au contacts; Sn/Pb alloy terminations (pigtail) <input checked="" type="checkbox"/>	7 50 μ" Au contacts; SAC305 terminations
7 50 μ" Au contacts; SAC305 terminations (pigtail)	

HARDWARE	
STYLE OF HARDWARE:	STYLE OF HARDWARE:
00 None	00 None
22 Two fixed jacknut assemblies (62*)	22 Two fixed jacknut assemblies (62*)
41 Two turning jackscrews, allen head, retaining ring (81*)	99 Keying hardware, see options below (Body material 2, 3 and 4 only)
Two long turning jackscrews, allen head, retaining ring (82*)	
42 retaining ring (82*)	
43 Two turning jackscrews, slot head, retaining ring (83*)	
44 Two long turning jackscrews, slot head, retaining ring (84*)	
45 Two turning jackscrews, allen head, captivated** (85*)	
99 Keying hardware, see options below (Body material 2, 3 and 4 only)	

POLARIZATION / WIRING:	
00 None	00 None
XX For wiring codes, see page MA-3 & MA-4	

OPTIONS	
KSXX Two turning jackscrews. See page MA-6 for keying options (KJ*)	KPXX Two fixed jacknuts and interfacial sealing gasket. See page MA-6 for keying options (KN*)
	900 Interfacial sealing gasket
	0B7 Threaded inserts and interfacial sealing gasket

* = Use numbers or letters in parenthesis when ordering size 100.

** = Captive hardware is factory installed and non-removable.

= Option not RoHS compliant



Cable to Board (Narrow Footprint)

.050"

9 thru 100 Contacts

Rugged Cable Rugged Board Mount

MM, MN

MK, ML

MM-322-051-253-4400
(METAL)

MN-321-051-253-4400
(PLASTIC)

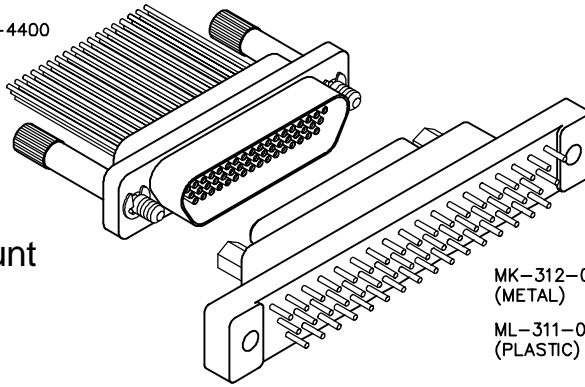

MK-312-051-135-2200
(METAL)

ML-311-051-135-2200
(PLASTIC)

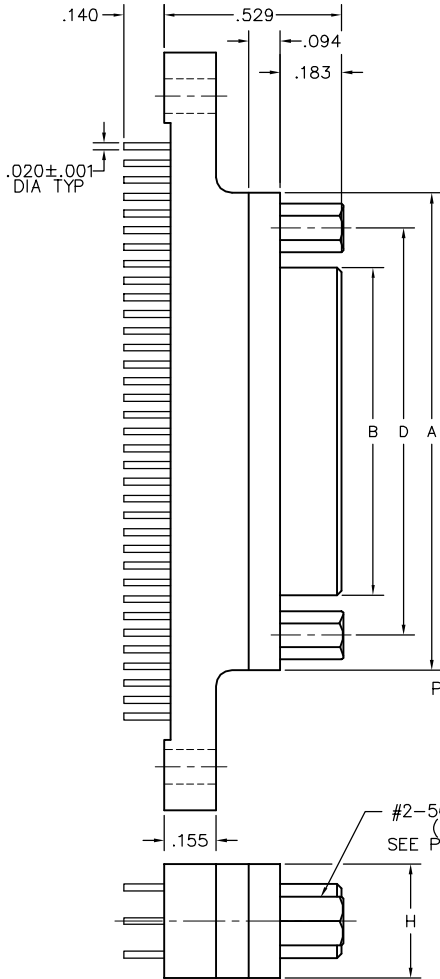

PLUG

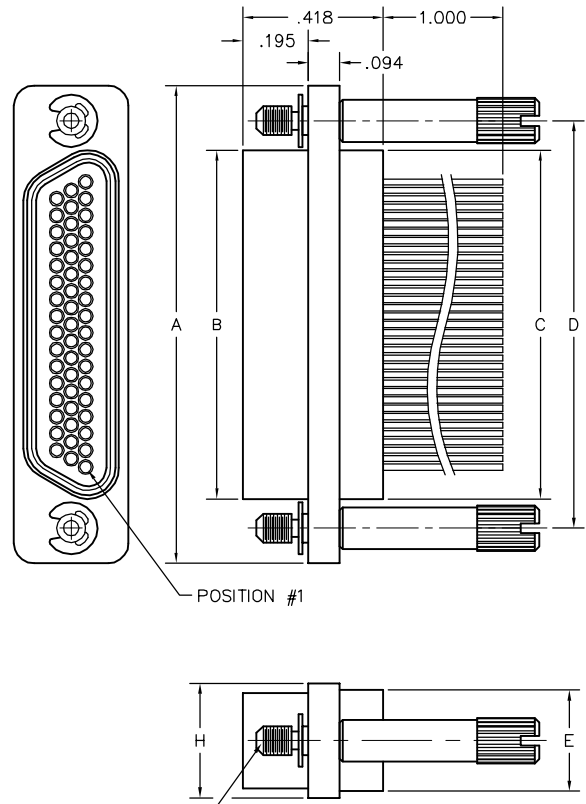
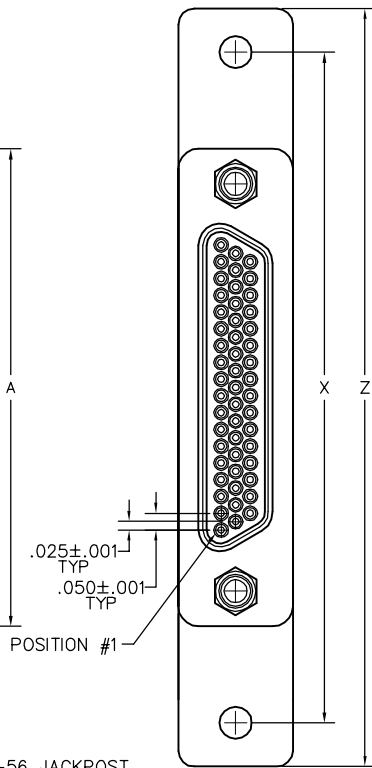

RECEPTACLE

SIZE	CONTACT ROWS	DIMENSIONS										
		A	B		C	D	E	H	X	Z	HARDWARE	MOUNTING HOLE
			PLUG MAX	RCPT MAX								
9	2	.775	.334	.400	.390	.565	.270	.298	1.150	1.390	#2-56 UNC THD	.096 DIA OR #2-56 UNC THREADED INSERT
15		.925	.484	.550	.540	.715			1.450	1.690		
21		1.075	.634	.700	.690	.865			1.500	1.740		
25		1.175	.734	.800	.790	.965			1.800	2.040		
31		1.325	.884	.950	.940	1.115			2.100	2.340		
37		1.475	1.034	1.100	1.090	1.265						
51	3	1.425	.984	1.050	1.040	1.215	.310	.341	2.000	2.270	#4-40 UNC THD	.125 DIA OR #2-56 UNC THREADED INSERT
100	4	2.160	1.384	1.508	1.432	1.800	.360	.384	2.800	3.240		

PLUG: MK-312-051-135-2200
RECEPTACLE: MM-322-051-253-4400
PLUG: ML-311-051-135-2200
RECEPTACLE: MN-321-051-253-4400

PLUG **RECEPTACLE** XX-XXX-XXX-XXX-XXXX-XXX

SERIES

MK .050" Rugged Metal PC Board Mount Connector ML .050" Rugged Plastic PC Board Mount Connector (MK & ML mate with MK, ML, MM, MN receptacles)	MM .050" Rugged Metal I/O Connector MN .050" Rugged Plastic I/O Connector (MM & MN mate with MK, ML, MM, MN plugs)
--	--

BODY

2 2-Row (Sizes 9 thru 37) 3 3-Row (Size 51) 4 4-Row (Size 100)	2 2-Row (Sizes 9 thru 37) 3 3-Row (Size 51) 4 4-Row (Size 100)
BODY STYLE: 1 Plug, straight, narrow footprint, w/ mtg holes	BODY STYLE: 2 Receptacle, straight, with ears
BODY MATERIAL: 1 Polyphenylene Sulfide (ML only) 2 Polyphenylene Sulfide with electroless nickel shell 3 Polyphenylene Sulfide with electrodeposited cadmium shell <input type="checkbox"/> 4 Polyphenylene Sulfide with hard anodized black shell 5 Polyphenylene Sulfide with stainless steel shell	BODY MATERIAL: 1 Polyphenylene Sulfide (MN only) 2 Polyphenylene Sulfide with electroless nickel shell 3 Polyphenylene Sulfide with electrodeposited cadmium shell <input checked="" type="checkbox"/> 4 Polyphenylene Sulfide with hard anodized black shell 5 Polyphenylene Sulfide with stainless steel shell

SIZE

XXX 009, 015, 021, 025, 031, 037, 051, 100	XXX 009, 015, 021, 025, 031, 037, 051, 100
--	--

CONTACTS

TYPE CONTACTS/TERMINATIONS: 12 Pin, straight, PCB leads, .109" 13 Pin, straight, PCB leads, .140" 14 Pin, straight, PCB leads, .172"	TYPE CONTACTS/TERMINATIONS: 21 Socket, straight, solder cup 24 Socket, straight, .500" pigtails (.018 dia) 25 Socket, straight, 1.000" pigtails (.018 dia) 26 Socket, straight, crimped wire
PLATING OPTIONS: 3 50 μ" Au contacts; 10 μ" Au terminations 5 50 μ" Au contacts; Sn/Pb alloy terminations <input checked="" type="checkbox"/> 7 50 μ" Au contacts; SAC305 terminations	PLATING OPTIONS: 1 50 μ" Au contacts (crimp wire) 3 50 μ" Au contacts; 10 μ" Au terminations (solder cup, pigtail) 5 50 μ" Au contacts; Sn/Pb alloy terminations (pigtail) <input checked="" type="checkbox"/> 7 50 μ" Au contacts; SAC305 terminations (pigtail)

HARDWARE

STYLE OF HARDWARE: 00 None 22 Two fixed jacknut assemblies (62*) 99 Keying hardware, see options below (Body material 2, 3 and 4 only)	STYLE OF HARDWARE: 00 None 22 Two fixed jacknut assemblies (62*) 41 Two turning jackscrews, allen head, retaining ring (81*) 42 Two long turning jackscrews, allen head, retaining ring (82*) 43 Two turning jackscrews, slot head, retaining ring (83*) 44 Two long turning jackscrews, slot head, retaining ring (84*) 45 Two turning jackscrews, allen head, captivated** (85*) 99 Keying hardware, see options below (Body material 2, 3 and 4 only)
--	---

POLARIZATION / WIRING:
 00 None

POLARIZATION / WIRING
 00 None
 XX For wiring codes, see page MA-3 & MA-4

OPTIONS

KPXX Two fixed jacknuts. See page MA-6 for keying options (KN*) 0B7 Threaded inserts	KSXX Two turning jackscrews and interfacial sealing gasket. See page MA-6 for keying options (KJ*) 900 Interfacial sealing gasket
---	--

* = Use numbers or letters in parenthesis when ordering size 100.
 ** = Captive hardware is factory installed and non-removable.
 = Option not RoHS compliant



Recommended PC Board Layout

Straight, Narrow Footprint

PLUG PC BOARD LAYOUT COMPONENT SIDE

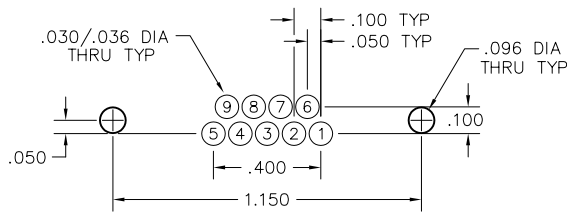

CONNECTOR MATING FACE (PLUG)

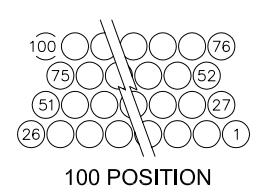
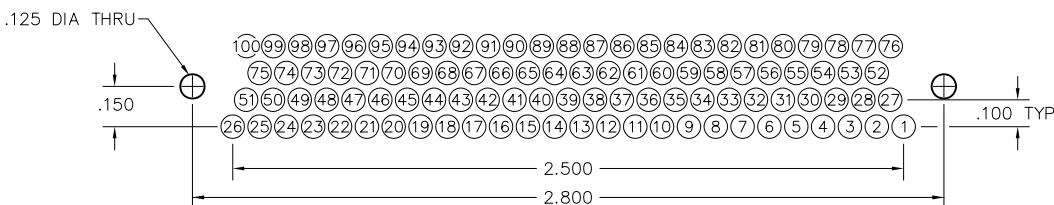
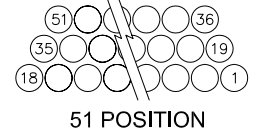
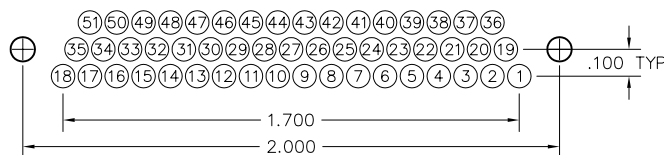
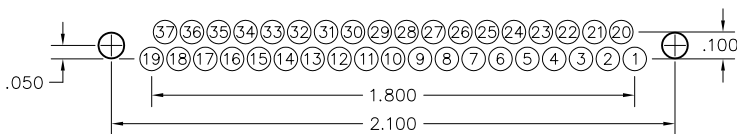
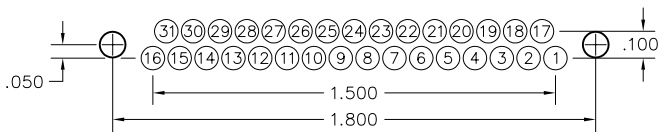
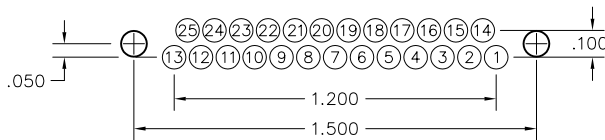
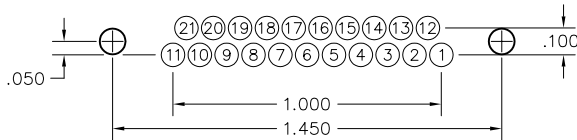
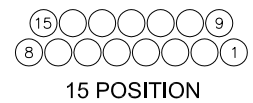
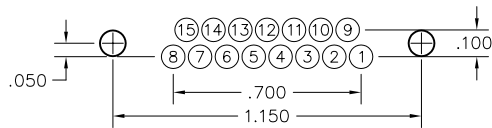
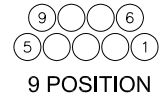

Recommended PC Board Layout

Straight, Narrow Footprint

RECEPTACLE PC BOARD LAYOUT COMPONENT SIDE

CONNECTOR MATING FACE (RECEPTACLE)

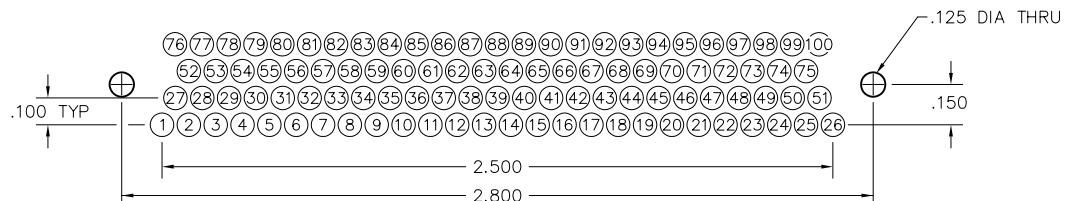
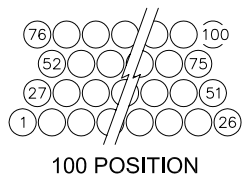
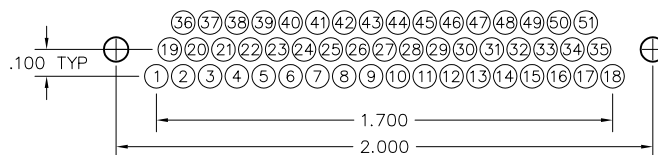
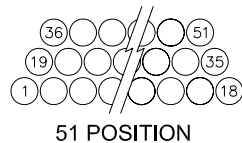
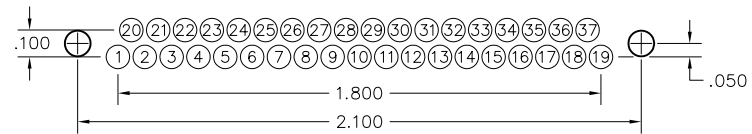
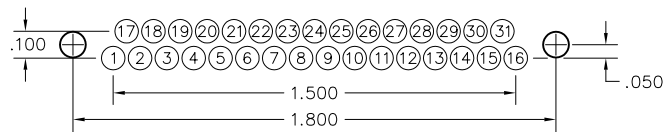
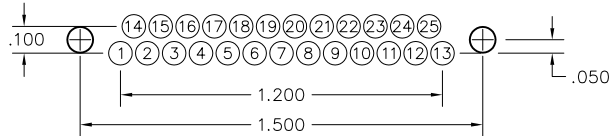
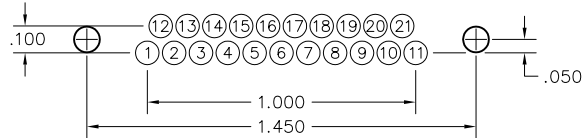
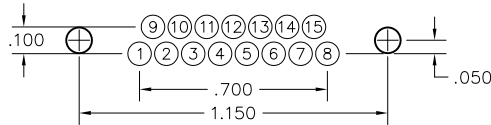
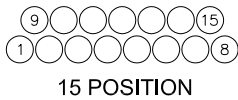
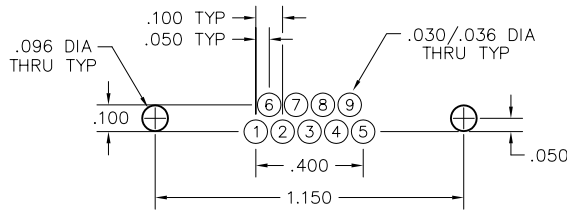
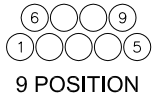



Cable to Board (Standard Footprint)

.050"

9 thru 100 Contacts

Rugged Cable

MM, MN

Rugged Board Mount

MK, ML

MM-312-051-161-45WP
(METAL)

MN-311-051-161-45WP
(PLASTIC)

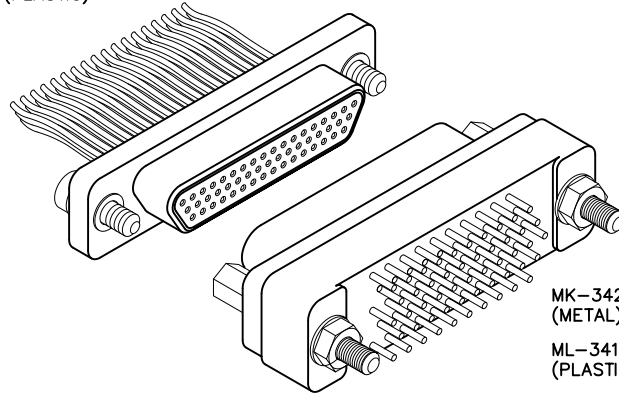

MK-342-051-225-2200
(METAL)

ML-341-051-225-2200
(PLASTIC)

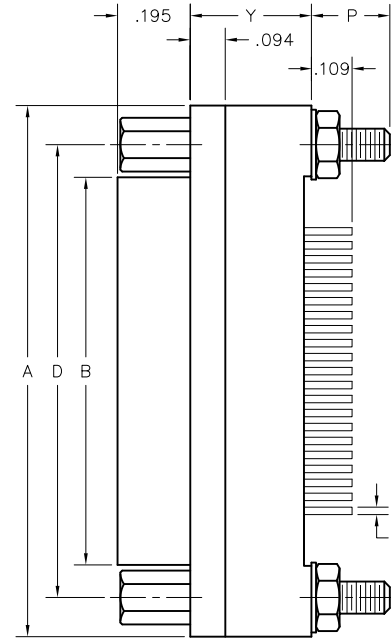
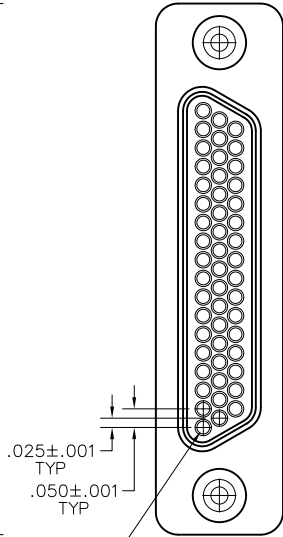
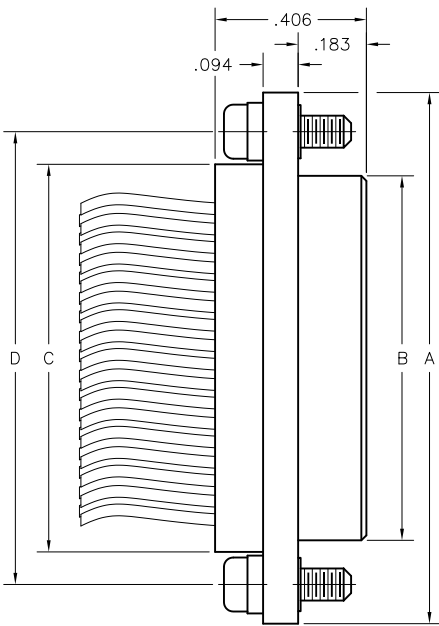

.020±.001
DIA TYP

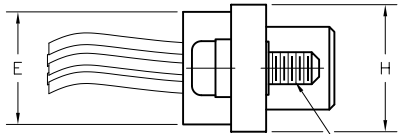

PLUG

#2-56 CAPTIVE
JACKSCREW (2 PLCS)
SEE PAGE MA-5

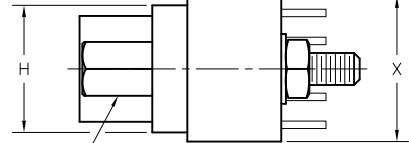

#2-56 JACKPOST
(2 PLCS)
SEE PAGE MA-5

RECEPTACLE

SIZE	CONTACT ROWS	DIMENSIONS										HARDWARE	
		A	B		C	D	E		H	P	X		Y
		PLUG MAX	RCPT MAX			POTTING WELL MAX							
9	2	.775	.334	.400	.390	.565	.270	.298	.210	.298	.280	.390	#2-56 UNC THD (#2-56 CLEARANCE OR #2-56 UNC THREADED INSERT)
15		.925	.484	.550	.540	.715						.540	
21		1.075	.634	.700	.690	.865						.690	
25		1.175	.734	.800	.790	.965						.780	
31		1.325	.884	.950	.940	1.115						.930	
37		1.475	1.034	1.100	1.090	1.265	.214	.330**	1.080				
51	3	1.425	.984	1.050	1.040	1.215	.310	.341	.219	.390	.325	1.046	#4-40 UNC THD (#4-40 CLEARANCE OR #4-40 UNC THREADED INSERT)
69		1.725	1.284	1.350	1.340	1.515						1.346	
100		2.160	1.384	1.508	1.432	1.800						.360	

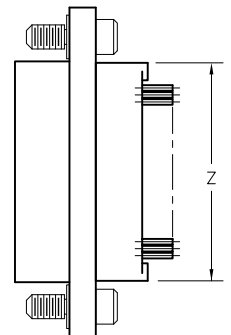

* = 69 POSITION CONNECTORS ARE AVAILABLE IN METAL ONLY.
 ** = 37 POSITION WITH TURNING HARDWARE "Y" DIMENSION IS .280.
 *** = "Z" DIMENSION FOR TURNING JACKSCREW ONLY

Call (972) 931-3200 Fax (972) 931-9305 www.AirBorn.com

PLUG: MM-312-051-161-45WP
RECEPTACLE: MK-342-051-225-2200
PLUG: MN-311-051-161-45WP
RECEPTACLE: ML-341-051-225-2200
 XX-XXX-XXX-XXX-XXXX-XXX

PLUG	RECEPTACLE
SERIES	
MM .050" Rugged Metal I/O Connector MN .050" Rugged Plastic I/O Connector (MM & MN mate with MK, ML, MM, MN receptacles)	MK .050" Rugged Metal PC Board Mount Connector ML .050" Rugged Plastic PC Board Mount Connector (MK & ML mate with MK, ML, MM, MN plugs)
BODY	
2 2-Row (Sizes 9 thru 37) 3 3-Row (Size 51 & 69***) 4 4-Row (Size 100)	2 2-Row (Sizes 9 thru 37) 3 3-Row (Size 51 & 69***) 4 4-Row (Size 100)
BODY STYLE: 1 Plug, straight, with ears	BODY STYLE: 4 Receptacle, straight, standard footprint
BODY MATERIAL: 1 Polyphenylene Sulfide (MN only) 2 Polyphenylene Sulfide with electroless nickel shell 3 Polyphenylene Sulfide with electrodeposited cadmium shell <input checked="" type="checkbox"/> 4 Polyphenylene Sulfide with hard anodized black shell 5 Polyphenylene Sulfide with stainless steel shell	BODY MATERIAL: 1 Polyphenylene Sulfide (ML only) 2 Polyphenylene Sulfide with electroless nickel shell 3 Polyphenylene Sulfide with electrodeposited cadmium shell <input checked="" type="checkbox"/> 4 Polyphenylene Sulfide with hard anodized black shell 5 Polyphenylene Sulfide with stainless steel shell
SIZE	
XXX 009, 015, 021, 025, 031, 037, 051, 069***, 100	XXX 009, 015, 021, 025, 031, 037, 051, 069***, 100
CONTACTS	
TYPE CONTACTS/TERMINATIONS: 11 Pin, straight, solder cup 14 Pin, straight, .500" pigtails (.018 dia) 15 Pin, straight, 1.000" pigtails (.018 dia) 16 Pin, straight, crimped wire	TYPE CONTACTS/TERMINATIONS: 22 Socket, straight, PCB leads, .109" 23 Socket, straight, PCB leads, .140" 24 Socket, straight, PCB leads, .172"
PLATING OPTIONS: 1 50 μ" Au contacts (crimp wire) 3 50 μ" Au contacts; 10 μ" Au terminations (solder cup, pigtail) 5 50 μ" Au contacts; Sn/Pb alloy terminations (pigtail) <input checked="" type="checkbox"/> 7 50 μ" Au contacts; SAC305 terminations (pigtail)	PLATING OPTIONS: 3 50 μ" Au contacts; 10 μ" Au terminations 5 50 μ" Au contacts; Sn/Pb alloy terminations <input checked="" type="checkbox"/> 7 50 μ" Au contacts; SAC305 terminations
HARDWARE	
STYLE OF HARDWARE: 00 None 22 Two fixed jacknut assemblies (62*) 41 Two turning jackscrews, allen head, retaining ring (81*) 42 Two long turning jackscrews, allen head, retaining ring (82*) 43 Two turning jackscrews, slot head, retaining ring (83*) 44 Two long turning jackscrews, slot head, retaining ring (84*) 45 Two turning jackscrews, allen head, captivated** (85*) 99 Keying hardware, see options below (Body material 2, 3 and 4 only)	STYLE OF HARDWARE: 00 None 22 Two fixed jacknut assemblies (62*) 41 Two turning jackscrews, allen head, retaining ring**** (81*) 99 Keying hardware, see options below (Body material 2, 3 and 4 only)
POLARIZATION / WIRING: 00 None XX For wiring codes, see page MA-3 & MA-4	POLARIZATION / WIRING 00 None
OPTIONS	
KSXX Two turning jackscrews. See page MA-6 for keying options (KJ*)	KPXX Two fixed jacknuts and interfacial sealing gasket. See page MA-6 for keying options (KN*) 900 Interfacial sealing gasket 0B7 Threaded inserts and interfacial sealing gasket

* = Use numbers or letters in parenthesis when ordering size 100. *** = 69 position connectors are available in metal only.
 ** = Captive hardware is factory installed and non-removable. **** = Connector body has no mounting holes.
 = Option not RoHS compliant



Cable to Board (Standard Footprint)

.050"
9 thru 100 Contacts
Rugged Cable

MM, MN

Rugged Board Mount

MK, ML

MM-322-051-261-45WP
(METAL)

MN-321-051-261-45WP
(PLASTIC)

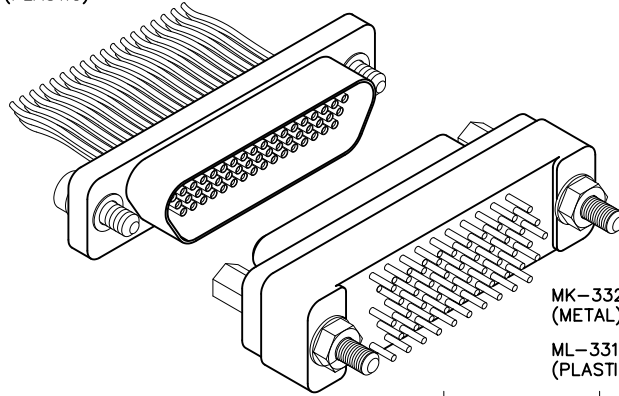

MK-332-051-125-2200
(METAL)

ML-331-051-125-2200
(PLASTIC)

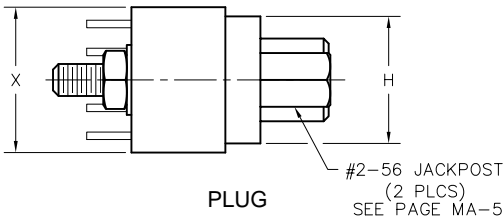
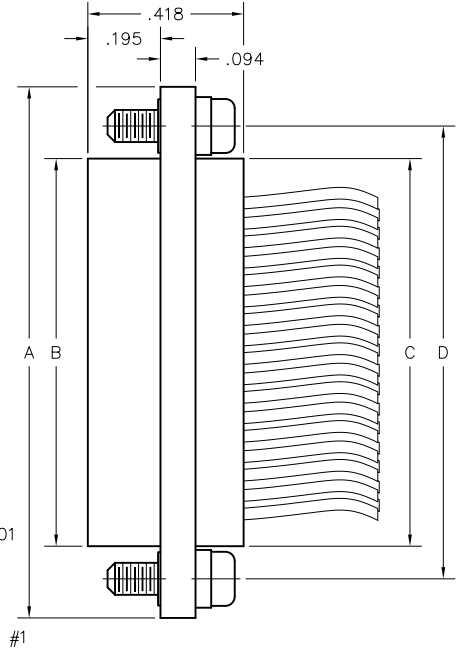
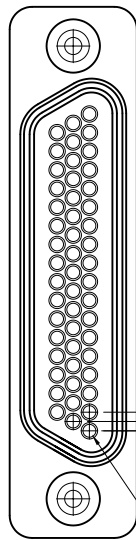
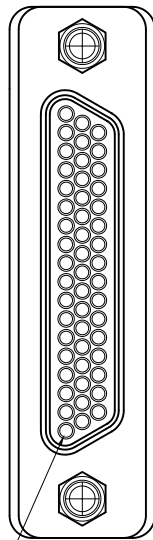
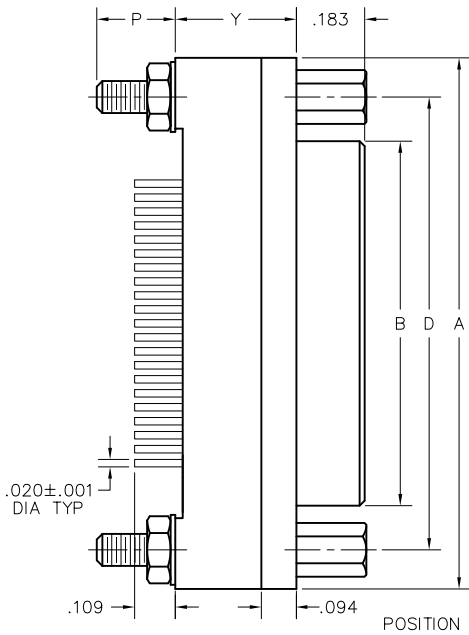

PLUG

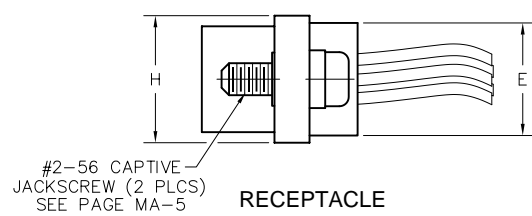

RECEPTACLE

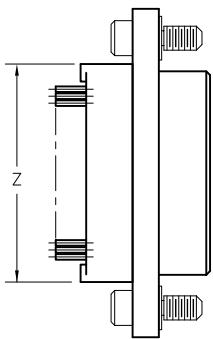

SIZE	CONTACT ROWS	DIMENSIONS											HARDWARE	
		A	B		C	D	E	H	P	X	Y	Z***		
			PLUG MAX	RCPT MAX										POTTING WELL MAX
9	2	.775	.334	.400	.390	.565	.270	.298	.210	.298	.280	.390	#2-56 UNC THD (#2-56 CLEARANCE OR #2-56 UNC THREADED INSERT)	
15		.925	.484	.550	.540	.715								.540
21		1.075	.634	.700	.690	.865								.690
25		1.175	.734	.800	.790	.965								.780
31		1.325	.884	.950	.940	1.115								.930
37	1.475	1.034	1.100	1.090	1.265	1.080	.330**							
51	3	1.425	.984	1.050	1.040	1.215	.310	.341	.219	.390	.325	1.046		
69		1.725	1.284	1.350	1.340	1.515								1.346
100		4	2.160	1.384	1.508	1.432								1.800

* = 69 POSITION CONNECTORS ARE AVAILABLE IN METAL ONLY.
 ** = 37 POSITION WITH TURNING HARDWARE "Y" DIMENSION IS .280.
 *** = "Z" DIMENSION FOR TURNING JACKSCREW ONLY

Call (972) 931-3200 Fax (972) 931-9305 www.AirBorn.com

PLUG: MK-332-051-125-2200
RECEPTACLE: MM-322-051-261-45WP
PLUG: ML-331-051-125-2200
RECEPTACLE: MN-321-051-261-45WP

PLUG		RECEPTACLE	
SERIES			
MK .050" Rugged Metal PC Board Mount Connector	MM .050" Rugged Metal I/O Connector	ML .050" Rugged Plastic PC Board Mount Connector	MN .050" Rugged Plastic I/O Connector
(MK & ML mate with MK, ML, MM, MN receptacles)		(MM & MN mate with MK, ML, MM, MN plugs)	
BODY			
2 2-Row (Sizes 9 thru 37)	2 2-Row (Sizes 9 thru 37)	3 3-Row (Size 51 & 69***)	3 3-Row (Size 51 & 69***)
4 4-Row (Size 100)	4 4-Row (Size 100)		
BODY STYLE:		BODY STYLE:	
3 Plug, straight, standard footprint	2 Receptacle, straight, with ears		
BODY MATERIAL:		BODY MATERIAL:	
1 Polyphenylene Sulfide (ML only)	1 Polyphenylene Sulfide (MN only)	2 Polyphenylene Sulfide with electroless nickel shell	2 Polyphenylene Sulfide with electroless nickel shell
3 Polyphenylene Sulfide with electrodeposited cadmium shell <input checked="" type="checkbox"/>	3 Polyphenylene Sulfide with electrodeposited cadmium shell <input checked="" type="checkbox"/>	4 Polyphenylene Sulfide with hard anodized black shell	4 Polyphenylene Sulfide with hard anodized black shell
5 Polyphenylene Sulfide with stainless steel shell	5 Polyphenylene Sulfide with stainless steel shell		
SIZE			
XXX 009, 015, 021, 025, 031, 037, 051, 069***, 100		XXX 009, 015, 021, 025, 031, 037, 051, 069***, 100	
CONTACTS			
TYPE CONTACTS/TERMINATIONS:		TYPE CONTACTS/TERMINATIONS:	
12 Pin, straight, PCB leads, .109"	21 Socket, straight, solder cup	24 Socket, straight, .500" pigtails (.018 dia)	25 Socket, straight, 1.000" pigtails (.018 dia)
13 Pin, straight, PCB leads, .140"	26 Socket, straight, crimped wire		
14 Pin, straight, PCB leads, .172"			
PLATING OPTIONS:		PLATING OPTIONS:	
3 50 μ" Au contacts; 10 μ" Au terminations	1 50 μ" Au contacts (crimp wire)	3 50 μ" Au contacts; 10 μ" Au terminations (solder cup, pigtail)	5 50 μ" Au contacts; Sn/Pb alloy terminations (pigtail) <input checked="" type="checkbox"/>
5 50 μ" Au contacts; Sn/Pb alloy terminations <input checked="" type="checkbox"/>	7 50 μ" Au contacts; SAC305 terminations	7 50 μ" Au contacts; SAC305 terminations (pigtail)	
HARDWARE			
STYLE OF HARDWARE:		STYLE OF HARDWARE:	
00 None	00 None	22 Two fixed jacknut assemblies (62*)	22 Two fixed jacknut assemblies (62*)
41 Two turning jackscrews, allen head, retaining ring**** (81*)	41 Two turning jackscrews, allen head, retaining ring (81*)	42 Two long turning jackscrews, allen head, retaining ring (82*)	43 Two turning jackscrews, slot head, retaining ring (83*)
99 Keying hardware, see options below (Body material 2, 3 and 4 only)	44 Two long turning jackscrews, slot head, retaining ring (84*)	45 Two turning jackscrews, allen head, captivated** (85*)	99 Keying hardware, see options below (Body material 2, 3 and 4 only)
POLARIZATION / WIRING:		POLARIZATION / WIRING	
00 None	00 None	XX For wiring codes, see page MA-3 & MA-4	
OPTIONS			
KPXX Two fixed jacknuts. See page MA-6 for keying options (KN*)	KSXX Two turning jackscrews and interfacial sealing gasket. See page MA-6 for keying options (KJ*)	0B7 Threaded inserts	900 Interfacial sealing gasket

* = Use numbers or letters in parenthesis when ordering size 100.

*** = 69 position connectors are available in metal only.

** = Captive hardware is factory installed and non-removable.

**** = Connector body has no mounting holes.

= Option not RoHS compliant

Recommended PC Board Layout

Straight, Standard Footprint

CONNECTOR
MATING FACE
(PLUG)



9 POSITION

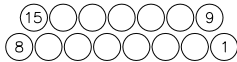

15 POSITION



21 POSITION



25 POSITION



31 POSITION



37 POSITION

PLUG
PC BOARD LAYOUT
COMPONENT SIDE

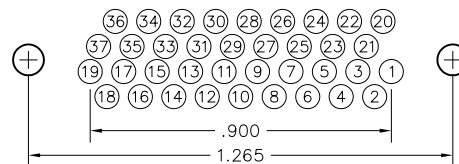
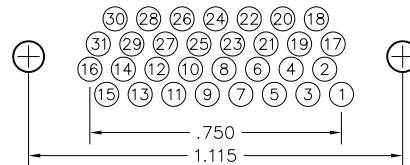
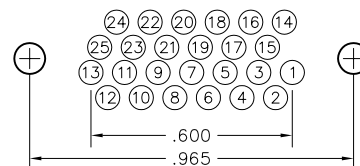
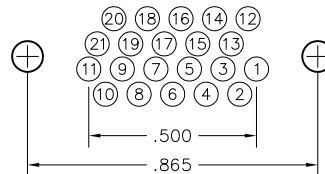
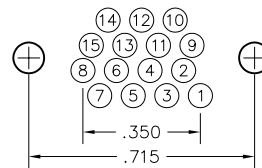
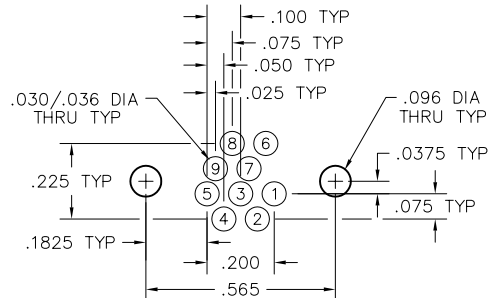

Recommended PC Board Layout

Straight, Standard Footprint

PLUG PC BOARD LAYOUT COMPONENT SIDE

CONNECTOR MATING FACE (PLUG)

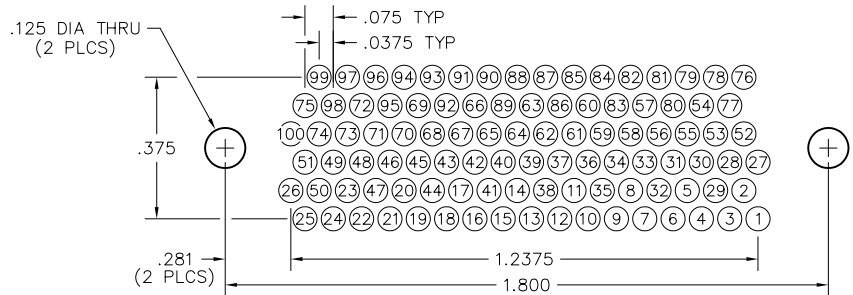
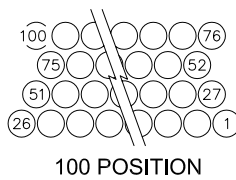
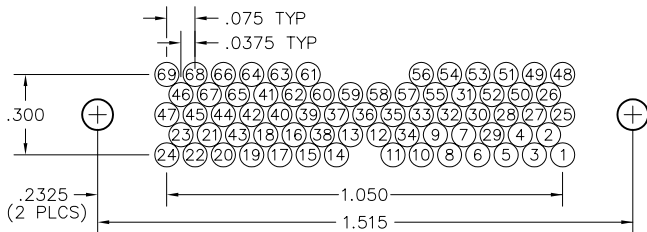
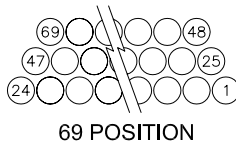
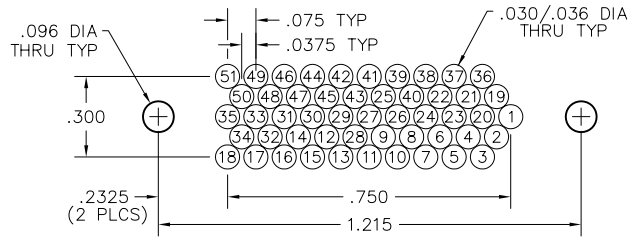
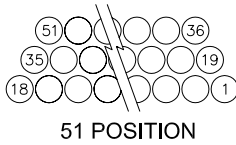



Recommended PC Board Layout

Straight, Standard Footprint

RECEPTACLE PC BOARD LAYOUT COMPONENT SIDE

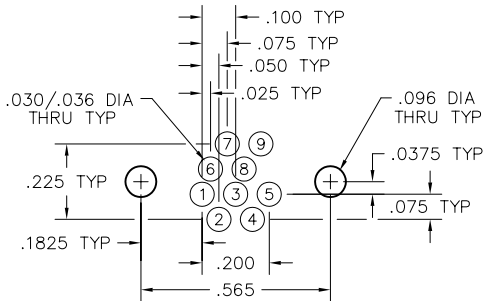

CONNECTOR MATING FACE (RECEPTACLE)

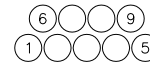

9 POSITION

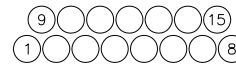

15 POSITION



21 POSITION



25 POSITION



31 POSITION



37 POSITION

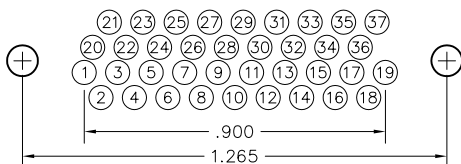
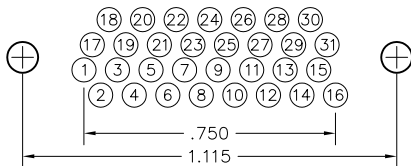
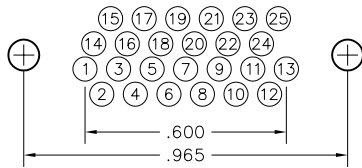
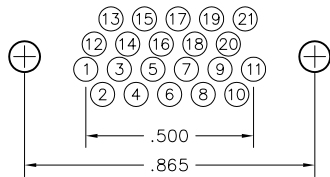
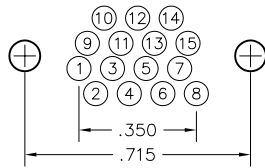

Recommended PC Board Layout

Straight, Standard Footprint

RECEPTACLE PC BOARD LAYOUT COMPONENT SIDE

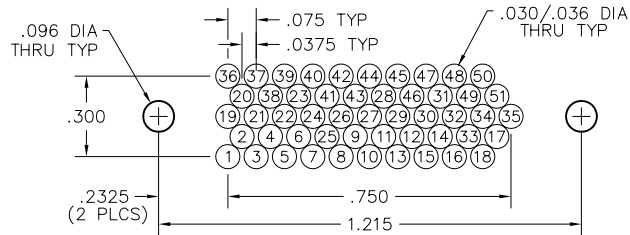

CONNECTOR MATING FACE (RECEPTACLE)

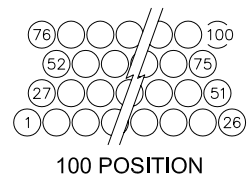
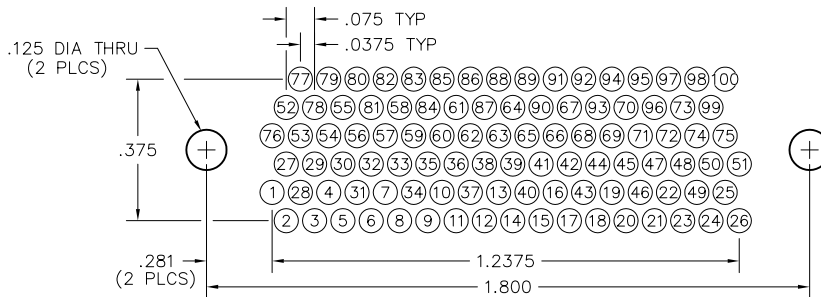
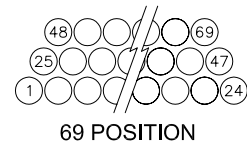
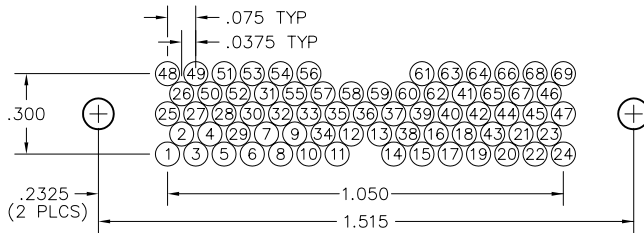
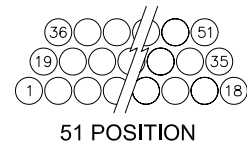



Specifications - Surface Mount Connectors Materials and Finishes *

Contacts:	Pins: BeCu alloy strip per ASTM B194 Sockets: Brass per ASTM B121 / B121M or ASTM B16 / B16M or ASTM B453
Contact Finish:	Gold plate per ASTM B488
Shells:	Aluminum Alloy 6061-T6 per SAE AMS-QQ-A-250/11 or 6061-T6511 per SAE AMS-QQ-A-200/8 or Stainless Steel 300 series per ASTM A484 / A484M and ASTM A582 / A582M Passivated per SAE AMS2700
Aluminum Shell Finishes:	Electroless Nickel per SAE AMS2404, Class 3, 500 μ " min Electrodeposited Cadmium per SAE AMS-QQ-P-416, Type II, Class 3 Black Anodized per MIL-A-8625, Type III, Class 2
Molded Insulators:	Glass filled polyphenylene sulfide per MIL-M-24519
Embedment:	Frey Engineering Co. insulating compound CF3003-80 and L-II-49 or equivalent
Jack screws, Jackposts and Nuts:	Corrosion resistant steel per ASTM A320 or ASTM A484 / A484M and ASTM A582 / A582M Passivated per SAE AMS2700
Clips and Washers:	Corrosion resistant steel per ASME 18.24 or NASM35333 or ASTM A484/A484M and ASTM A582/A582M (For reference only: ASME 18.24 CRS per ASTM A693 and NASM35333 CRS per ASTM A240) Passivated per ASME 18.24 or NASM35333 or SAE AMS2700 (For reference only: ASME 18.24 and NASM35333 passivated per SAE AMS2700)
Brackets:	Card Edge Mount: Aluminum Alloy 7075-T6 per SAE AMS-QQ-A-250/12 or SAE AMS-QQ-A-200/11 Plating consistent with Aluminum Shell Horizontal Surface Mount: Corrosion resistant steel per ASTM A240 Passivated per SAE AMS2700
Interfacial Seal Gaskets:	Fluorosilicone per SAE AMS-R-25988
Tolerances:	Unless otherwise specified: Fractions = $\pm 1/64$ " Decimals = ± 0.010 " Angles = $\pm 5^\circ$ Wire lengths: uninsulated/solid = $+0.2"/-0.0$ "

Note: AirBorn can manufacture special configurations for your exact specifications.

* = Reference the above listed specifications or an equivalent industry standard when applicable

Performance - Surface Mount Connectors

Contact Rating:	3-amperes maximum
Solderability:	Terminals (except crimp) tested in accordance with MIL-STD-202, Method 208
Wire Size:	Solid #30 AWG standard (consult factory for other sizes and types)
Test Voltage:	600 V, RMS, 60 Hz
Operating Temperature:	-55° C to +125° C
Insulation Resistance:	5,000 megohms minimum @ 500 VDC
Durability:	500 connector mating cycles
Vibration:	Tested in accordance with MIL-STD-1344, Method 2005, Condition IV, according to MIL-83513
Shock:	Tested in accordance with MIL-STD-1344, Method 2004, Condition E, according to MIL-83513
Salt Spray:	Mated connectors tested in accordance with MIL-STD-1344, Method 1001, Test Condition B
Humidity:	Mated connectors tested in accordance with MIL-STD-1344, Method 1002, Type II (except steps 7a and 7b)
Thermal Shock:	Tested to the temperature extremes of MIL-STD-1344, Method 1003, Test Condition A (except step 3, temperature shall be 125° C)
Contact Resistance:	0.065 volt maximum drop @ 2.5 amps (.026 ohms)
Contact Engaging Force:	6.0 ounce maximum, with .0221 diameter test sleeve
Contact Separating Force:	0.5 ounce minimum, with .0230 diameter test sleeve
Crimp Strength:	5 pound minimum tensile strength



Board SMT to Cable

.050"

9 thru 51 Contacts

Rugged Metal

MM

Rugged Plastic

MN

MM-223-025-275-320S
(METAL)

MN-221-025-275-320S
(PLASTIC)

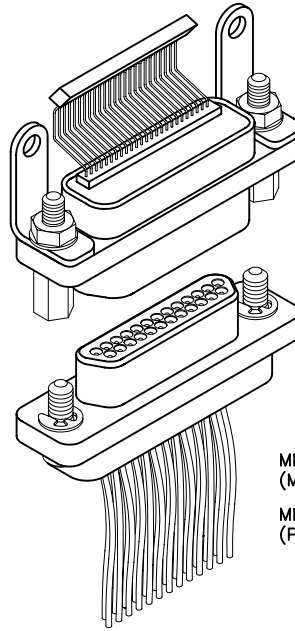

MM-213-025-161-41WQ
(METAL)

MN-211-025-161-41WQ
(PLASTIC)

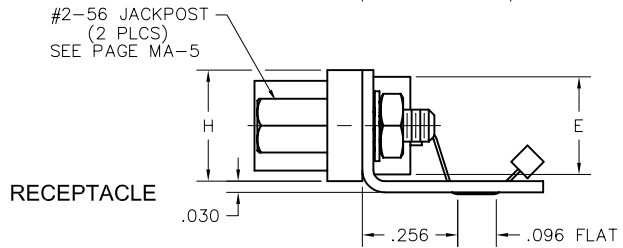
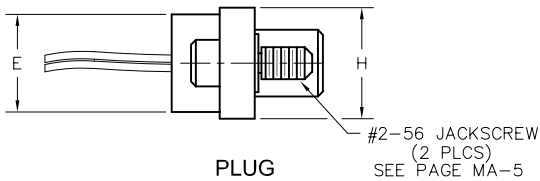
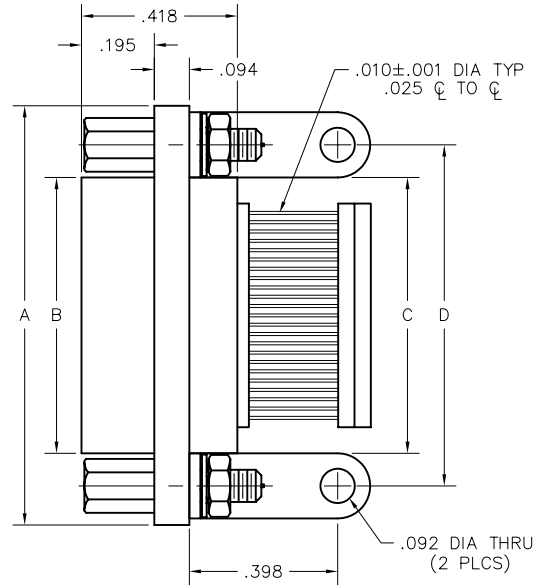
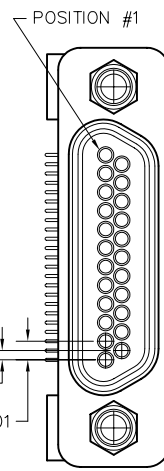
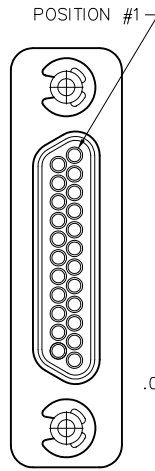
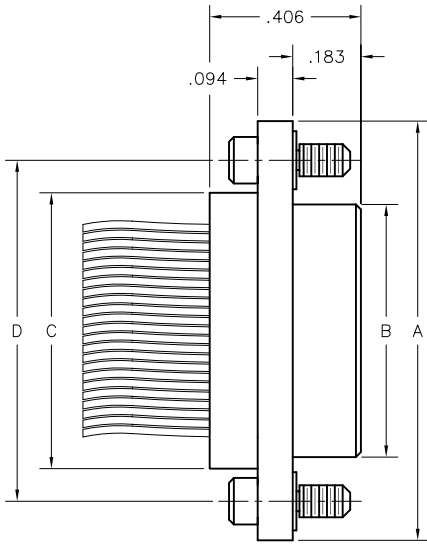

DIMENSIONS										
SIZE	CONTACT ROWS	A	B		C	D	E		H	HARDWARE
			PLUG MAX	RCPT MAX			POTTING WELL MAX			
9	2	.775	.334	.400	.390	.565	.270	.298	#2-56 UNC THD (.092 DIA THRU)	
15		.925	.484	.550	.540	.715				
21		1.075	.634	.700	.690	.865				
25		1.175	.734	.800	.790	.965				
31		1.325	.884	.950	.940	1.115				
37		1.475	1.034	1.100	1.090	1.265				
51*		1.825	1.384	1.450	1.440	1.615				

* = 51 POSITION CONNECTORS ARE AVAILABLE IN METAL ONLY.

PLUG: MM-213-025-161-41WQ
RECEPTACLE: MM-223-025-275-320S
PLUG: MN-211-025-161-41WQ
RECEPTACLE: MN-221-025-275-320S
 XX-XXX-XXX-XXX-XXXX-XXX

PLUG
RECEPTACLE

SERIES	
MM .050" Rugged Metal I/O Connector MN .050" Rugged Plastic I/O Connector (MM & MN mate with MK, ML, MM, MN receptacles)	MM .050" Rugged Metal PC Board Mount, SMT Connector MN .050" Rugged Plastic PC Board Mount, SMT Connector (MM & MN mate with MK, ML, MM, MN plugs)
BODY	
2 2-Row (Sizes 9 thru 51***)	2 2-Row (Sizes 9 thru 51***)
BODY STYLE: 1 Plug, straight, with ears	BODY STYLE: 2 Receptacle, straight, with ears
BODY MATERIAL: 1 Polyphenylene Sulfide (MN only) 2 Polyphenylene Sulfide with electroless nickel shell 3 Polyphenylene Sulfide with electrodeposited cadmium shell <input checked="" type="checkbox"/> 4 Polyphenylene Sulfide with hard anodized black shell 5 Polyphenylene Sulfide with stainless steel shell	BODY MATERIAL: 1 Polyphenylene Sulfide (MN only) 2 Polyphenylene Sulfide with electroless nickel shell 3 Polyphenylene Sulfide with electrodeposited cadmium shell <input checked="" type="checkbox"/> 4 Polyphenylene Sulfide with hard anodized black shell 5 Polyphenylene Sulfide with stainless steel shell
SIZE	
XXX 009, 015, 021, 025, 031, 037, 051***	XXX 009, 015, 021, 025, 031, 037, 051***
CONTACTS	
TYPE CONTACTS/TERMINATIONS: 11 Pin, straight, solder cup 14 Pin, straight, .500" pigtails (.018 dia) 15 Pin, straight, 1.000" pigtails (.018 dia) 16 Pin, straight, crimped wire	TYPE CONTACTS/TERMINATIONS: 27 Socket, Surface Mount
PLATING OPTIONS: 1 50 μ" Au contacts (crimp wire) 3 50 μ" Au contacts: 10 μ" Au terminations (solder cup, pigtail) 5 50 μ" Au contacts; Sn/Pb alloy terminations (pigtail) <input checked="" type="checkbox"/> 7 50 μ" Au contacts; SAC305 terminations (pigtail)	PLATING OPTIONS: 5 50 μ" Au contacts; Sn/Pb alloy terminations <input checked="" type="checkbox"/> 8 50 μ" Au contacts; Sn plated terminations
HARDWARE	
STYLE OF HARDWARE: 00 None 22 Two fixed jacknut assemblies 41 Two turning jackscrews, allen head, retaining ring 42 Two long turning jackscrews, allen head, retaining ring 43 Two turning jackscrews, slot head, retaining ring 44 Two long turning jackscrews, slot head, retaining ring 45 Two turning jackscrews, allen head, captivated**	STYLE OF HARDWARE: 00 None 32 Two fixed jacknut assemblies with mounting bracket 46 Two turning jackscrews, allen head, captivated** with mounting bracket
POLARIZATION / WIRING: 00 None XX For wiring codes, see page MA-3 & MA-4	POLARIZATION / WIRING: 0R Reverse Body Polarization 0S Standard Body Polarization
OPTIONS	
900 Interfacial sealing gasket	

** = Captive hardware is factory installed and non-removable.

*** = 51 position connectors are available in metal only (non Mil-Spec interface).

= Option not RoHS compliant



Board SMT to Cable

.050"

9 thru 51 Contacts

Rugged Metal

MM

Rugged Plastic

MN

MM-212-025-175-320S
(METAL)

MN-211-025-175-320S
(PLASTIC)

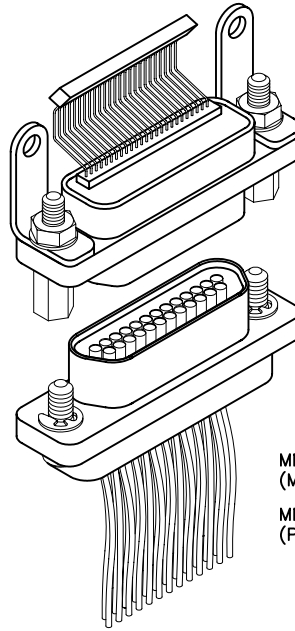

MM-222-025-261-41WQ
(METAL)

MN-221-025-261-41WQ
(PLASTIC)

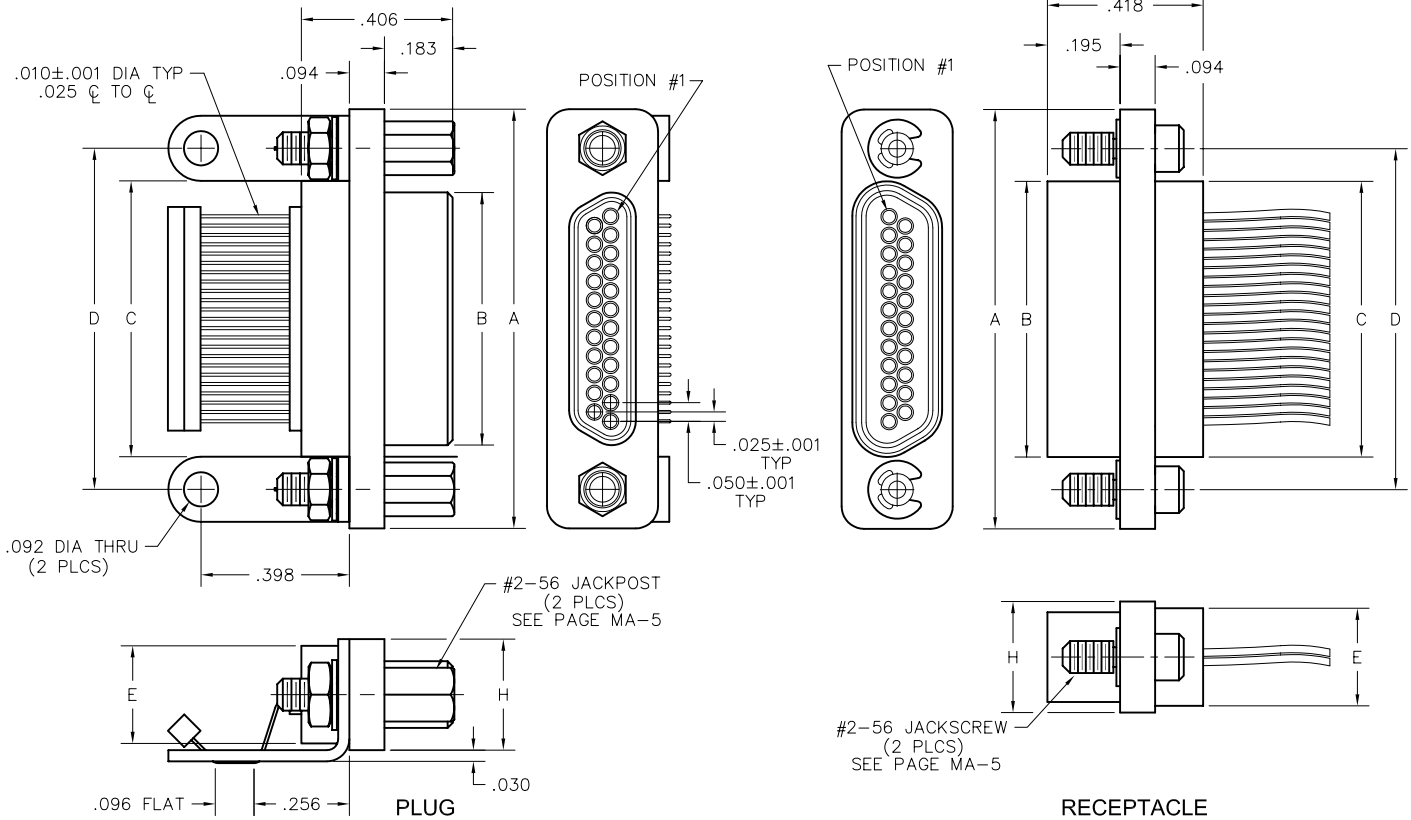

SIZE	CONTACT ROWS	DIMENSIONS							
		A	B		C	D	E	H	HARDWARE
			PLUG MAX	RCPT MAX					
9	2	.775	.334	.400	.390	.565	.270	.298	#2-56 UNC THD (.092 DIA THRU)
15		.925	.484	.550	.540	.715			
21		1.075	.634	.700	.690	.865			
25		1.175	.734	.800	.790	.965			
31		1.325	.884	.950	.940	1.115			
37		1.475	1.034	1.100	1.090	1.265			
51*		1.825	1.384	1.450	1.440	1.615			

* = 51 POSITION CONNECTORS ARE AVAILABLE IN METAL ONLY.

PLUG: MM-212-025-175-320S
RECEPTACLE: MM-222-025-261-41WQ
PLUG: MN-211-025-175-320S
RECEPTACLE: MN-221-025-261-41WQ
 XX-XXX-XXX-XXX-XXXX-XXX

PLUG		RECEPTACLE	
SERIES			
MM .050" Rugged Metal PC Board Mount, SMT Connector	MN .050" Rugged Plastic PC Board Mount, SMT Connector (MM & MN mate with MK, ML, MM, MN receptacles)	MM .050" Rugged Metal I/O Connector	MN .050" Rugged Plastic I/O Connector (MM & MN mate with MK, ML, MM, MN plugs)
BODY			
2 2-Row (Sizes 9 thru 51***)		2 2-Row (Sizes 9 thru 51***)	
BODY STYLE:		BODY STYLE:	
1 Plug, straight, with ears		2 Receptacle, straight, with ears	
BODY MATERIAL:		BODY MATERIAL:	
1 Polyphenylene Sulfide (MN only)		1 Polyphenylene Sulfide (MN only)	
2 Polyphenylene Sulfide with electroless nickel shell		2 Polyphenylene Sulfide with electroless nickel shell	
3 Polyphenylene Sulfide with electrodeposited cadmium shell <input checked="" type="checkbox"/>		3 Polyphenylene Sulfide with electrodeposited cadmium shell <input checked="" type="checkbox"/>	
4 Polyphenylene Sulfide with hard anodized black shell		4 Polyphenylene Sulfide with hard anodized black shell	
5 Polyphenylene Sulfide with stainless steel shell		5 Polyphenylene Sulfide with stainless steel shell	
SIZE			
XXX 009, 015, 021, 025, 031, 037, 051***		XXX 009, 015, 021, 025, 031, 037, 051***	
CONTACTS			
TYPE CONTACTS/TERMINATIONS:		TYPE CONTACTS/TERMINATIONS:	
17 Pin, Surface Mount		21 Socket, straight, solder cup	
		24 Socket, straight, .500" pigtails (.018 dia)	
		25 Socket, straight, 1.000" pigtails (.018 dia)	
		26 Socket, straight, crimped wire	
PLATING OPTIONS:		PLATING OPTIONS:	
5 50 μ" Au contacts; Sn/Pb alloy terminations <input checked="" type="checkbox"/>		1 50 μ" Au contacts (crimp wire)	
8 50 μ" Au contacts; Sn plated terminations		3 50 μ" Au contacts; 10 μ" Au terminations (solder cup, pigtail)	
		5 50 μ" Au contacts; Sn/Pb alloy terminations (pigtail) <input checked="" type="checkbox"/>	
		7 50 μ" Au contacts; SAC305 terminations (pigtail)	
HARDWARE			
STYLE OF HARDWARE:		STYLE OF HARDWARE:	
00 None		00 None	
32 Two fixed jacknut assemblies with mounting bracket		22 Two fixed jacknut assemblies	
46 Two turning jackscrews, allen head, captivated** with mounting bracket		41 Two turning jackscrews, allen head, retaining ring	
		42 Two long turning jackscrews, allen head, retaining ring	
		43 Two turning jackscrews, slot head, retaining ring	
		44 Two long turning jackscrews, slot head, retaining ring	
		45 Two turning jackscrews, allen head, captivated**	
POLARIZATION / WIRING:		POLARIZATION / WIRING	
0R Reverse Body Polarization		00 None	
0S Standard Body Polarization		XX For wiring codes, see page MA-3 & MA-4	
OPTIONS			
		900 Interfacial sealing gasket	

** = Captive hardware is factory installed and non-removable.
 *** = 51 position connectors are available in metal only (non Mil-Spec interface).
 = Option not RoHS compliant



Recommended PC Board Layout

Surface Mount
Standard Polarization

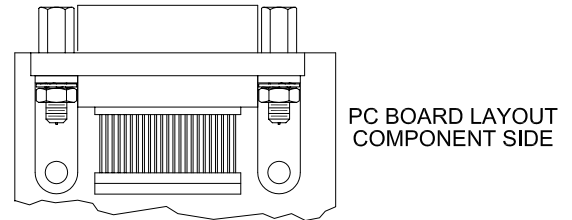
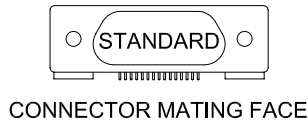

PLUG
PC BOARD LAYOUT
COMPONENT SIDE

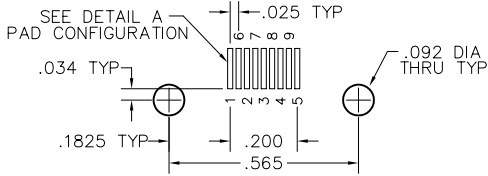

CONNECTOR
MATING FACE*
(RECEPTACLE)
9 POSITION

RECEPTACLE
PC BOARD LAYOUT
COMPONENT SIDE

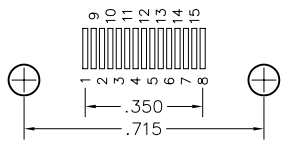
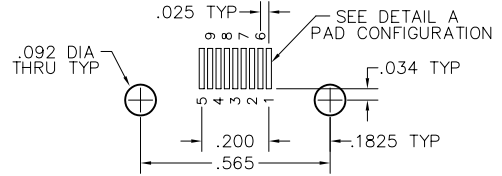

15 POSITION

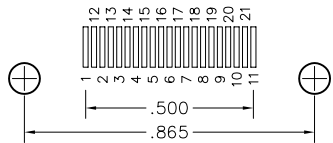
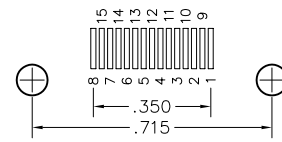

21 POSITION

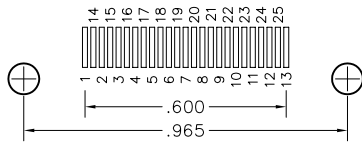
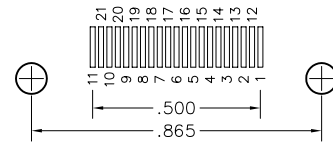

25 POSITION

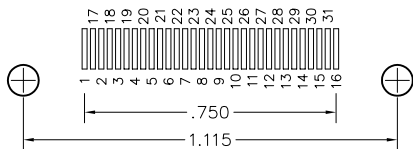
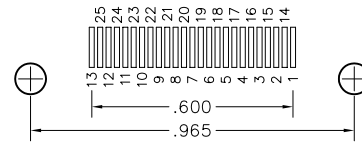

31 POSITION

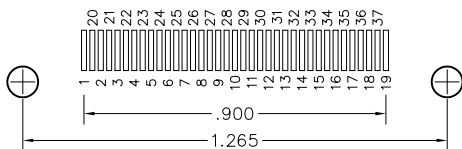

37 POSITION

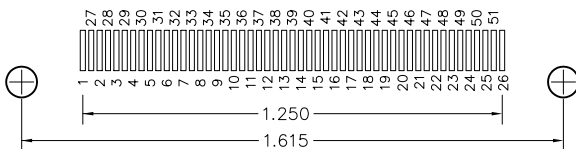
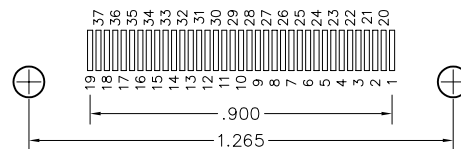

51 POSITION



* For pin (plug) connectors, the contact numbers are reversed left to right.

MATING FACE THIS SIDE

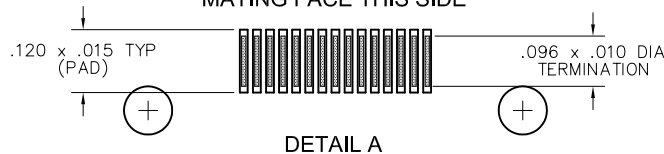



CONNECTOR MATING FACE

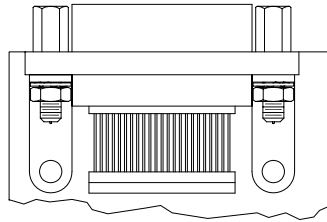

PC BOARD LAYOUT COMPONENT SIDE



Recommended PC Board Layout

Surface Mount
Reverse Polarization

PLUG
PC BOARD LAYOUT
COMPONENT SIDE

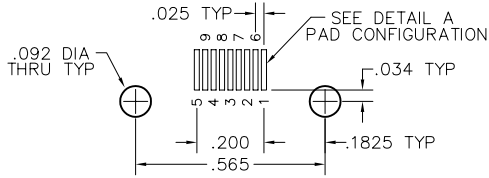

CONNECTOR MATING FACE*
(RECEPTACLE)

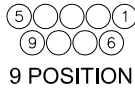

RECEPTACLE
PC BOARD LAYOUT
COMPONENT SIDE

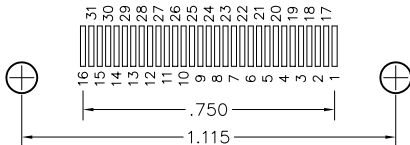
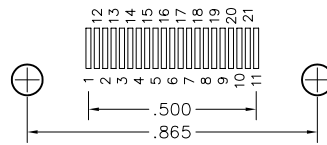
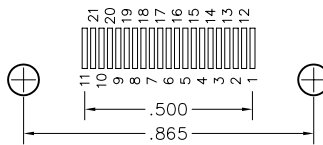
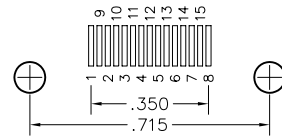
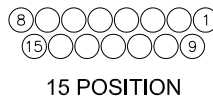
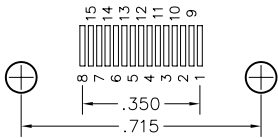
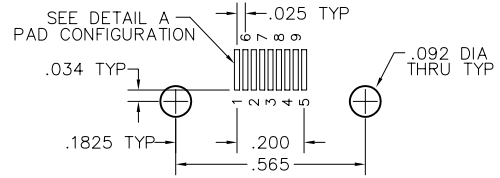

* For pin (plug) connectors, the contact numbers are reversed left to right.

MATING FACE THIS SIDE

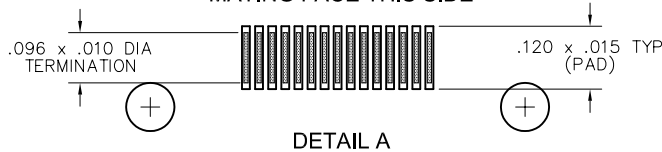

DETAIL A



Cable to Board (Vertical Surface Mount)

.050"

9 thru 51 Contacts

Rugged Surface Mount

MK

Rugged Cable

MM

MM-212-031-161-22WQ
(METAL)

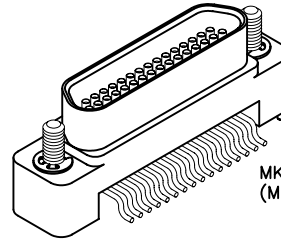
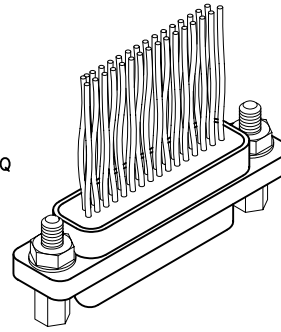

MK-2J2-031-475-4100
(METAL)

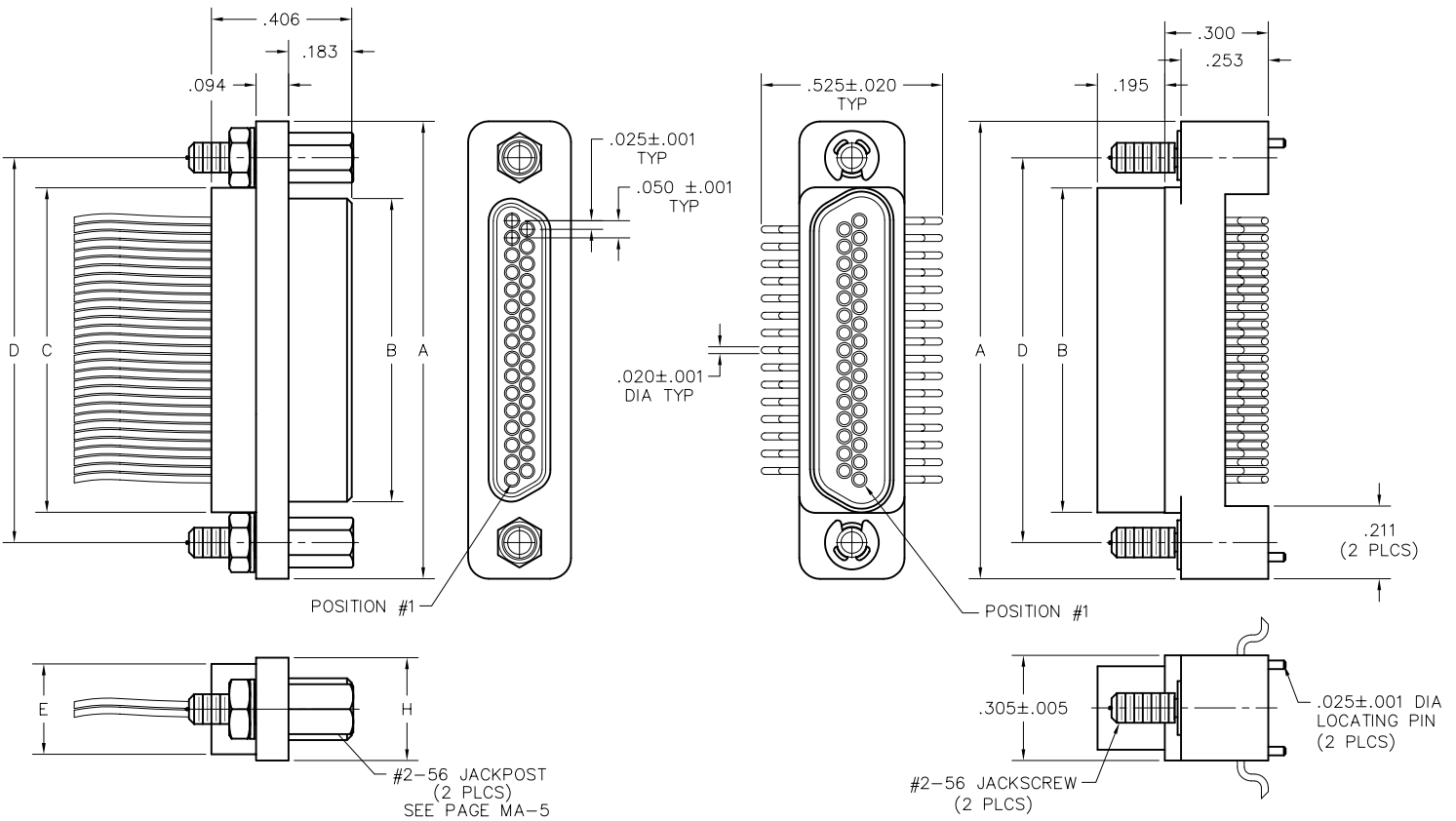

PLUG

RECEPTACLE

SIZE	CONTACT ROWS	DIMENSIONS							
		A	B		C	D	E	H	HARDWARE
			PLUG MAX	RCPT MAX					
9	2	.775	.334	.400	.390	.565	.270	.298	#2-56 UNC THD (.092 DIA THRU)
15		.925	.484	.550	.540	.715			
21		1.075	.634	.700	.690	.865			
25		1.175	.734	.800	.790	.965			
31		1.325	.884	.950	.940	1.115			
37		1.475	1.034	1.100	1.090	1.265			
51*		1.825	1.384	1.450	1.440	1.615			

* = 51 POSITION CONNECTORS ARE NON-MIL SPEC INTERFACE

PLUG: MM-212-031-161-41WQ
 RECEPTACLE: MK-2J2-031-475-2200
 XX-XXX-XXX-XXX-XXXX-XXX

PLUG

RECEPTACLE

SERIES

MM .050" Rugged Metal I/O Connector (MM mates with MK, ML, MM, MN receptacles)	MK .050" Rugged Metal Surface Mount Connector (MK mates with MK, ML, MM, MN plugs)
---	---

BODY

2 2-Row (Sizes 9 thru 51*)	2 2-Row (Sizes 9 thru 51*)
----------------------------	----------------------------

BODY STYLE: 1 Plug, straight, with ears	BODY STYLE: J Receptacle, vertical surface mount
---	--

BODY MATERIAL: 2 Polyphenylene Sulfide with electroless nickel shell 3 Polyphenylene Sulfide with electrodeposited cadmium shell <input checked="" type="checkbox"/> 4 Polyphenylene Sulfide with hard anodized black shell	BODY MATERIAL: 2 Polyphenylene Sulfide with electroless nickel shell 3 Polyphenylene Sulfide with electrodeposited cadmium shell <input checked="" type="checkbox"/> 4 Polyphenylene Sulfide with hard anodized black shell
---	---

SIZE

XXX 009, 015, 021, 025, 031, 037, 051*	XXX 009, 015, 021, 025, 031, 037, 051*
--	--

CONTACTS

TYPE CONTACTS/TERMINATIONS: 11 Pin, straight, solder cup 14 Pin, straight, .500" pigtails (.018 dia) 15 Pin, straight, 1.000" pigtails (.018 dia) 16 Pin, straight, crimped wire	TYPE CONTACTS/TERMINATIONS: 47 Socket, vertical smt
---	---

PLATING OPTIONS: 1 50 μ" Au contacts (crimp wire) 3 50 μ" Au contacts: 10 μ" Au terminations (solder cup, pigtail) 5 50 μ" Au contacts; Sn/Pb alloy terminations (pigtail) <input checked="" type="checkbox"/> 7 50 μ" Au contacts; SAC305 terminations (pigtail)	PLATING OPTIONS: 5 50 μ" Au contacts; Sn/Pb alloy terminations <input checked="" type="checkbox"/> 7 50 μ" Au contacts; SAC305 terminations
--	--

HARDWARE

STYLE OF HARDWARE: 00 None 22 Two fixed jacknut assemblies 41 Two turning jackscrews, allen head, retaining ring 42 Two long turning jackscrews, allen head, retaining ring 43 Two turning jackscrews, slot head, retaining ring 44 Two long turning jackscrews, slot head, retaining ring 45 Two turning jackscrews, allen head, captivated** 99 Keying hardware, see options below	STYLE OF HARDWARE: 00 None 22 Two fixed jacknut assemblies 41 Two turning jackscrews, allen head, retaining ring 99 Keying hardware, see options below
---	---

POLARIZATION / WIRING: 00 None XX For wiring codes, see page MA-3 & MA-4	POLARIZATION / WIRING 00 None
---	---

OPTIONS

KSXX Two turning jackscrews. See page MA-6 for keying options	KPXX Two fixed jacknuts and interfacial sealing gasket. See page MA-6 for keying options 900 Interfacial sealing gasket
---	--

* = 2 row, 51 position connectors are non-Mil Spec interface.
 ** = Captive hardware is factory installed and non-removable.
 = Option not RoHS compliant



Cable to Board (Vertical Surface Mount)

.050"

9 thru 51 Contacts

Rugged Surface Mount

MK

Rugged Cable

MM

MM-222-031-261-41WQ
(METAL)

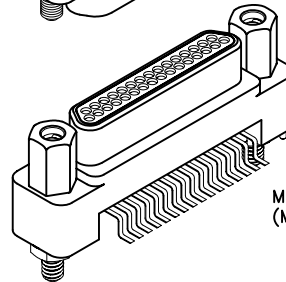
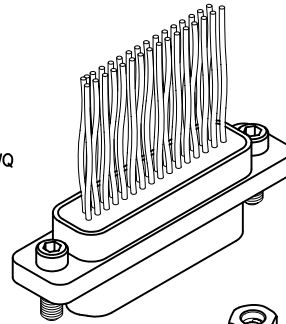

MK-2H2-031-375-2200
(METAL)

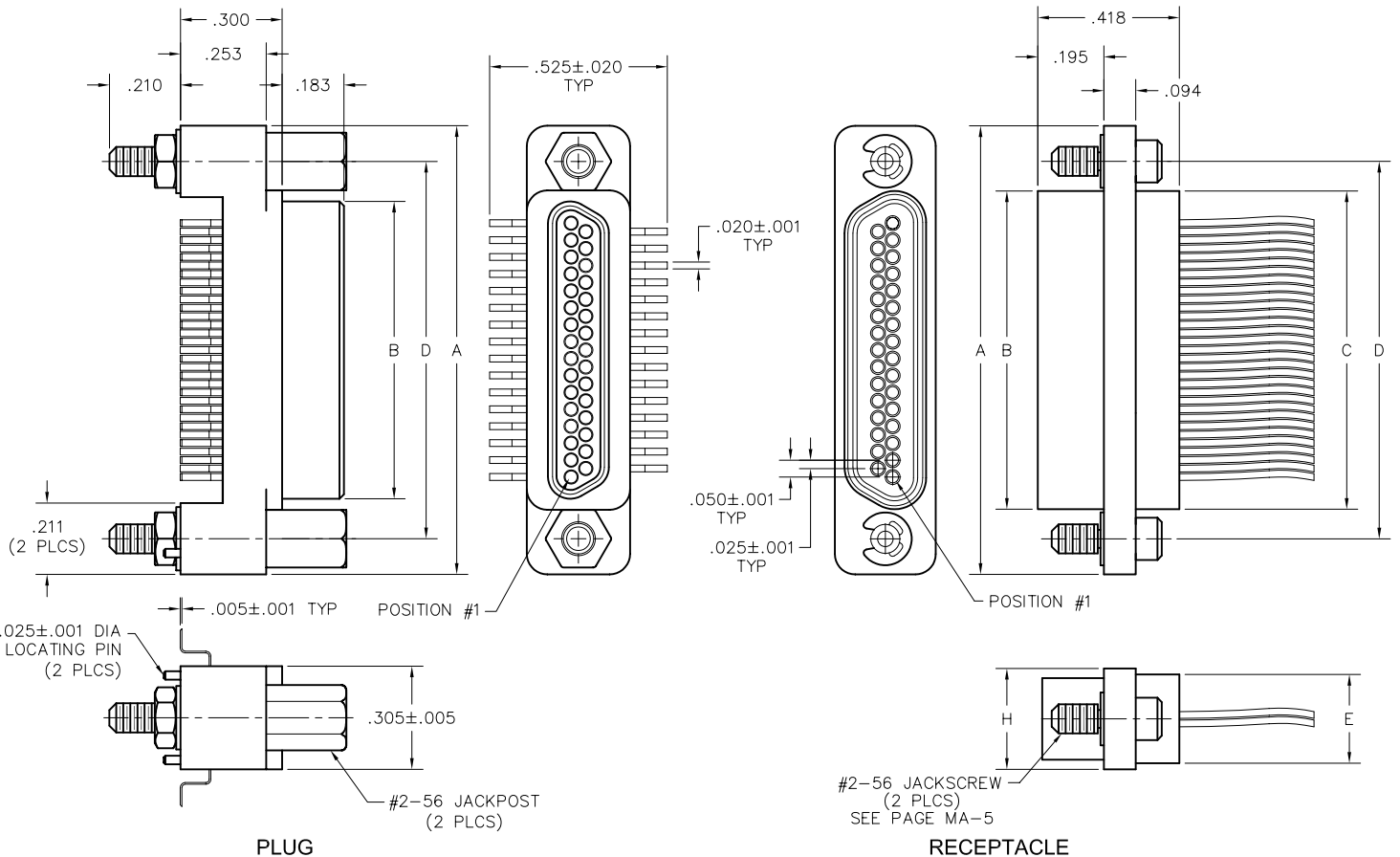

SIZE	CONTACT ROWS	DIMENSIONS							
		A	B		C	D	E	H	HARDWARE
			PLUG MAX	RCPT MAX					
9	2	.775	.334	.400	.390	.565	.270	.298	#2-56 UNC THD (.092 DIA THRU)
15		.925	.484	.550	.540	.715			
21		1.075	.634	.700	.690	.865			
25		1.175	.734	.800	.790	.965			
31		1.325	.884	.950	.940	1.115			
37		1.475	1.034	1.100	1.090	1.265			
51*		1.825	1.384	1.450	1.440	1.615			

* = 51 POSITION CONNECTORS ARE NON-MIL SPEC INTERFACE

PLUG: MK-2H3-031-375-2200

RECEPTACLE: MM-223-031-213-4100

XX-XXX-XXX-XXX-XXXX-XXX

PLUG		RECEPTACLE	
SERIES			
MK .050" Rugged Metal Surface Mount Connector (MK mates with MK, ML, MM, MN receptacles)		MM .050" Rugged Metal I/O Connector (MM mates with MK, ML, MM, MN plugs)	
BODY			
2 2-Row (Sizes 9 thru 51*)		2 2-Row (Sizes 9 thru 51*)	
BODY STYLE: H Plug, vertical surface mount		BODY STYLE: 2 Receptacle, straight, with ears	
BODY MATERIAL: 2 Polyphenylene Sulfide with electroless nickel shell 3 Polyphenylene Sulfide with electrodeposited cadmium shell <input checked="" type="checkbox"/> 4 Polyphenylene Sulfide with hard anodized black shell		BODY MATERIAL: 2 Polyphenylene Sulfide with electroless nickel shell 3 Polyphenylene Sulfide with electrodeposited cadmium shell <input checked="" type="checkbox"/> 4 Polyphenylene Sulfide with hard anodized black shell	
SIZE			
XXX 009, 015, 021, 025, 031, 037, 051*		XXX 009, 015, 021, 025, 031, 037, 051*	
CONTACTS			
TYPE CONTACTS/TERMINATIONS: 37 Pin, vertical smt		TYPE CONTACTS/TERMINATIONS: 21 Socket, straight, solder cup 24 Socket, straight, .500" pigtails (.018 dia) 25 Socket, straight, 1.000" pigtails (.018 dia) 26 Socket, straight, crimped wire	
PLATING OPTIONS: 5 50 μ" Au contacts; Sn/Pb alloy terminations <input checked="" type="checkbox"/> 7 50 μ" Au contacts; SAC305 terminations		PLATING OPTIONS: 1 50 μ" Au contacts (crimp wire) 3 50 μ" Au contacts: 10 μ" Au terminations (solder cup, pigtail) 5 50 μ" Au contacts; Sn/Pb alloy terminations (pigtail) <input checked="" type="checkbox"/> 7 50 μ" Au contacts; SAC305 terminations (pigtail)	
HARDWARE			
STYLE OF HARDWARE: 00 None 22 Two fixed jacknut assemblies 41 Two turning jackscrews, allen head, retaining ring 99 Keying hardware, see options below		STYLE OF HARDWARE: 00 None 22 Two fixed jacknut assemblies 41 Two turning jackscrews, allen head, retaining ring 42 Two long turning jackscrews, allen head, retaining ring 43 Two turning jackscrews, slot head, retaining ring 44 Two long turning jackscrews, slot head, retaining ring 45 Two turning jackscrews, allen head, captivated** 99 Keying hardware, see options below	
POLARIZATION / WIRING: 00 None		POLARIZATION / WIRING: 00 None XX For wiring codes, see page MA-3 & MA-4	
OPTIONS			
KPXX Two fixed jacknuts. See page MA-6 for keying options		KSXX Two turning jackscrews and interfacial sealing gasket. See page MA-6 for keying options 900 Interfacial sealing gasket	

* = 2 row, 51 position connectors are non-Mil Spec interface.

** = Captive hardware is factory installed and non-removable.

= Option not RoHS compliant



Recommended PC Board Layout

Vertical Surface Mount

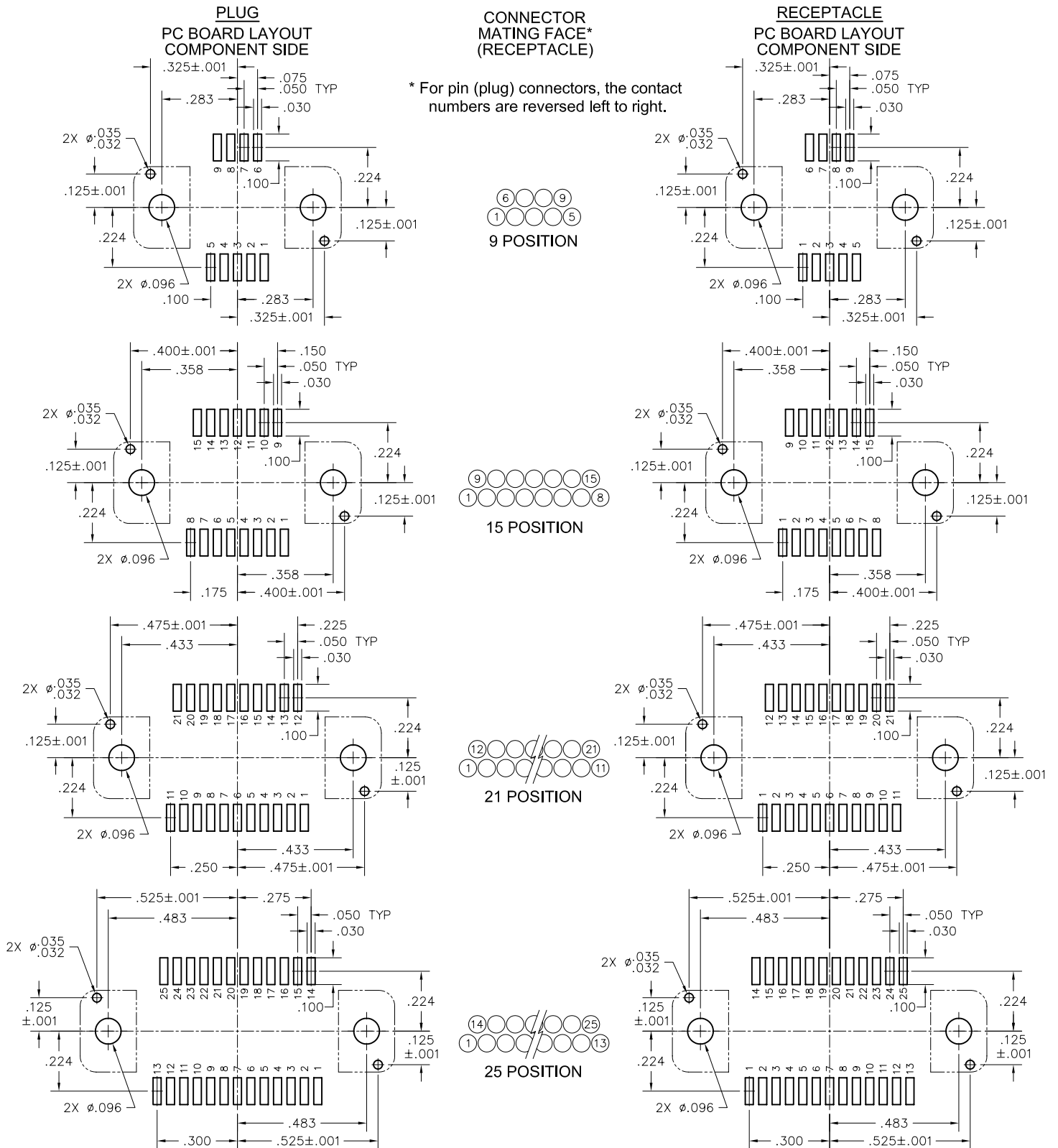

Recommended PC Board Layout

Vertical Surface Mount

PLUG
PC BOARD LAYOUT
COMPONENT SIDE

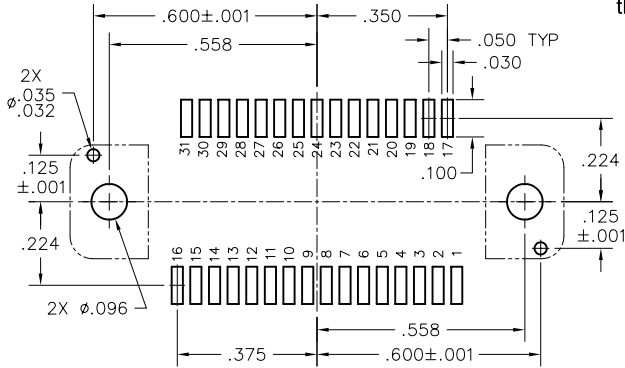

CONNECTOR MATING FACE*
(RECEPTACLE)

* For pin (plug) connectors, the contact numbers are reversed left to right.



RECEPTACLE
PC BOARD LAYOUT
COMPONENT SIDE

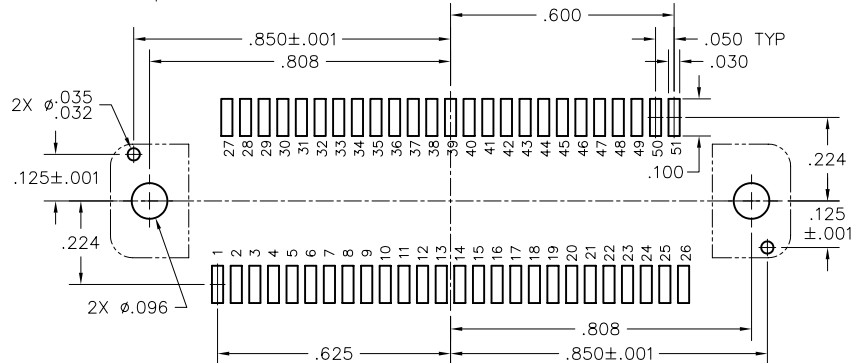
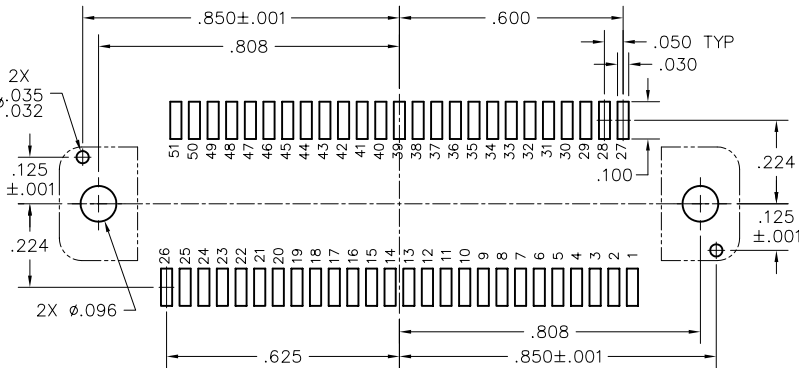
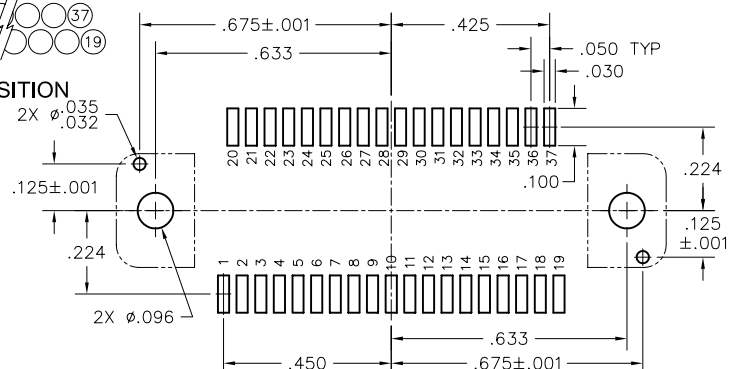
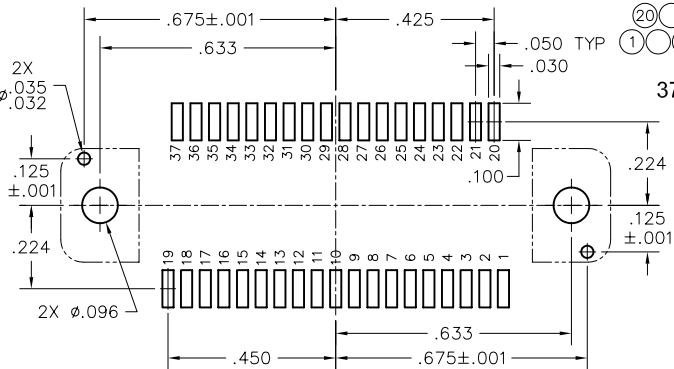
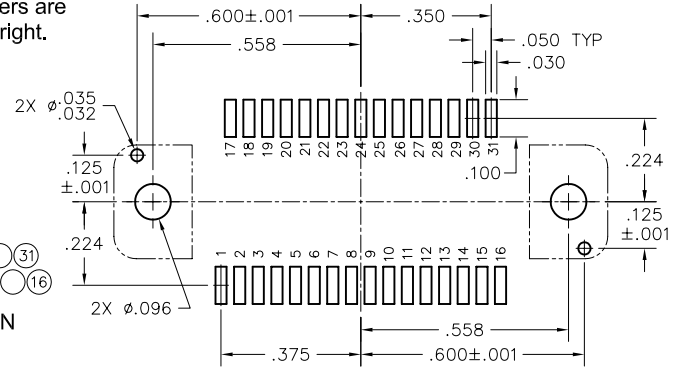



Card Edge Mount to Cable

.050"

9 thru 100 Contacts

MK-2G2-037-275-460S
(METAL)

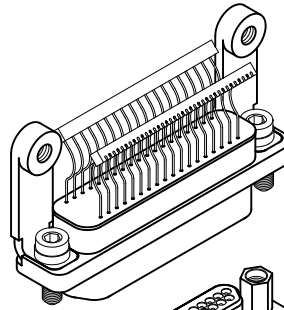

Rugged Card Edge Mount

MK

Rugged Metal

MM

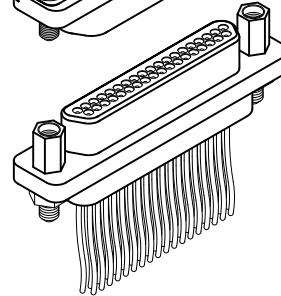

MM-212-037-161-22WQ
(METAL)

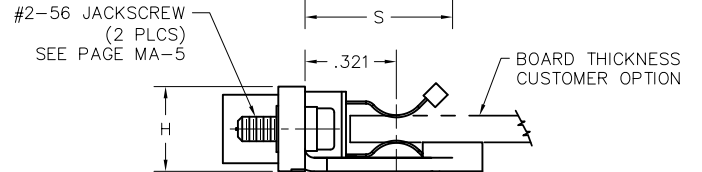
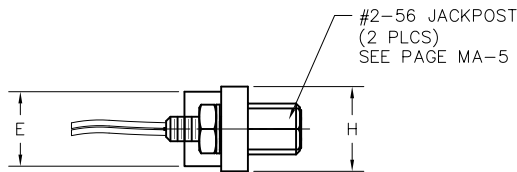
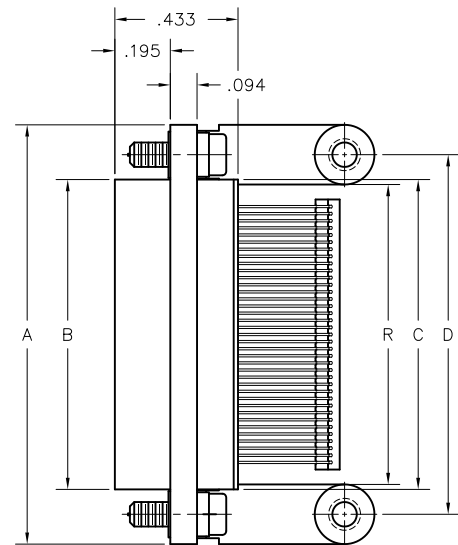
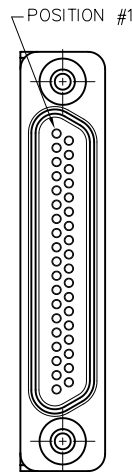
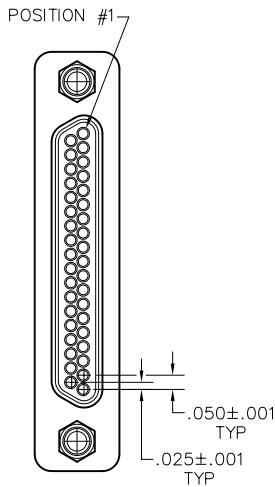
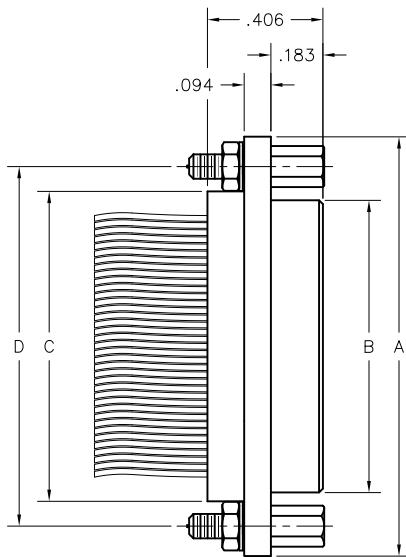

PLUG

RECEPTACLE

SIZE	CONTACT ROWS	DIMENSIONS										
		A	B		C	D	E POTTING WELL MAX	H	HARDWARE	MOUNTING HOLES	R	S
			PLUG MAX	RCPT MAX								
9	2	.775	.334	.400	.390	.565	.270	.298	#2-56 UNC THD	#4-40 UNC THD	.355	.519
15		.925	.484	.550	.540	.715					.505	
21		1.075	.634	.700	.690	.865					.655	
25		1.175	.734	.800	.790	.965					.755	
31		1.325	.884	.950	.940	1.115					.905	
37		1.475	1.034	1.100	1.090	1.265					1.055	
51	3	1.425	.984	1.050	1.040	1.215	.310	.341	#4-40 UNC THD	#4-40 UNC THD	1.005	
69		1.725	1.284	1.350	1.340	1.515					1.309	
100		2.160	1.384	1.508	1.432	1.800					.360	.384

PLUG: MM-212-031-161-22WQ
RECEPTACLE: MK-2G2-031-275-460S-900
 XX-XXX-XXX-XXX-XXXX-XXX

PLUG		RECEPTACLE	
SERIES			
MM .050" Rugged Metal I/O Connector (MM mates with MK, ML, MM, MN receptacles)		MK .050" Rugged Metal Card Edge Mount (MK mates with MK, ML, MM, MN plugs)	
BODY			
2 2-Row (Sizes 9 thru 37)	2 2-Row (Sizes 9 thru 37)	3 3-Row (Size 51 & 69)	3 3-Row (Size 51 & 69)
4 4-Row (Size 100)	4 4-Row (Size 100)		
BODY STYLE: 1 Plug, straight, with ears		BODY STYLE: G Receptacle, straight, card edge with mounting brackets	
BODY MATERIAL: 2 Polyphenylene Sulfide with electroless nickel shell 3 Polyphenylene Sulfide with electrodeposited cadmium shell <input checked="" type="checkbox"/> 4 Polyphenylene Sulfide with hard anodized black shell		BODY MATERIAL: 2 Polyphenylene Sulfide with electroless nickel shell 3 Polyphenylene Sulfide with electrodeposited cadmium shell <input checked="" type="checkbox"/> 4 Polyphenylene Sulfide with hard anodized black shell	
SIZE			
XXX 009, 015, 021, 025, 031, 037, 051, 069, 100		XXX 009, 015, 021, 025, 031, 037, 051, 069, 100	
CONTACTS			
TYPE CONTACTS/TERMINATIONS: 11 Pin, straight, solder cup 14 Pin, straight, .500" pigtails (.018 dia) 15 Pin, straight, 1.000" pigtails (.018 dia) 16 Pin, straight, crimped wire		TYPE CONTACTS/TERMINATIONS: 27 Socket, surface mount, .062-.094" pcb thickness (.010 dia) 28 Socket, surface mount, .109-.140" pcb thickness (.010 dia)	
PLATING OPTIONS: 1 50 μ" Au contacts (crimp wire) 3 50 μ" Au contacts; 10 μ" Au terminations (solder cup, pigtail) 5 50 μ" Au contacts; Sn/Pb alloy terminations (pigtail) <input checked="" type="checkbox"/> 7 50 μ" Au contacts; SAC305 terminations (pigtail)		PLATING OPTIONS: 5 50 μ" Au contacts; Sn/Pb alloy terminations <input checked="" type="checkbox"/> 8 50 μ" Au contacts; Sn plated terminations	
HARDWARE			
STYLE OF HARDWARE: 00 None 22 Two fixed jacknut assemblies (62*) 41 Two turning jackscrews, allen head, retaining ring (81*) 42 Two long turning jackscrews, allen head, retaining ring (82*) 43 Two turning jackscrews, slot head, retaining ring (83*) 44 Two long turning jackscrews, slot head, retaining ring (84*) 45 Two turning jackscrews, allen head, captivated** (85*)		STYLE OF HARDWARE: 32 Two fixed jacknut assemblies (72*) 46 Two turning jackscrews, allen head, captivated** (86*)	
POLARIZATION / WIRING: 00 None XX For wiring codes, see page MA-3 & MA-4		POLARIZATION / WIRING 0S Standard Body Polarization	
OPTIONS			
900 Interfacial sealing gasket			

* = Use number in parenthesis when ordering size 100.

** = Captive hardware is factory installed and non-removable.

= Option not RoHS compliant



Card Edge Mount to Cable

.050"

9 thru 100 Contacts

Rugged Card Edge Mount

MK

Rugged Metal

MM

MK-2F2-037-175-320S
(METAL)

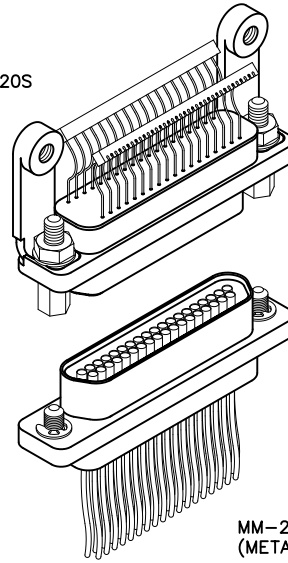

MM-222-037-261-41WQ
(METAL)

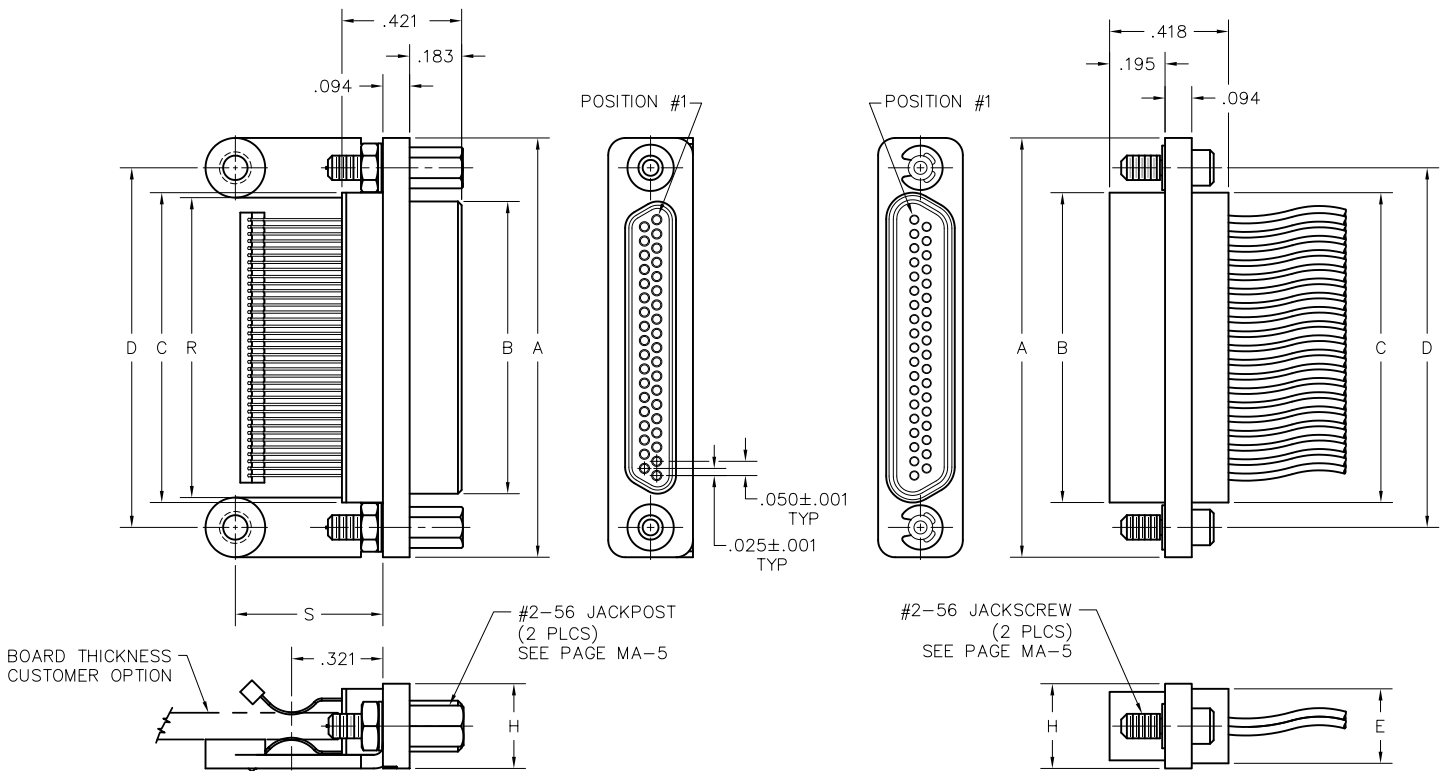

PLUG

RECEPTACLE

SIZE	CONTACT ROWS	DIMENSIONS										
		A	B		C	D	E	H	HARDWARE	MOUNTING HOLES	R	S
			PLUG MAX	RCPT MAX								
9	2	.775	.334	.400	.390	.565	.270	.298	#2-56 UNC THD	#4-40 UNC THD		.519
15		.925	.484	.550	.540	.715						
21		1.075	.634	.700	.690	.865						
25		1.175	.734	.800	.790	.965						
31		1.325	.884	.950	.940	1.115						
37	1.475	1.034	1.100	1.090	1.265	.310	.341	#4-40 UNC THD				
51	1.425	.984	1.050	1.040	1.215							
69	1.725	1.284	1.350	1.340	1.515							
100	4	2.160	1.384	1.508	1.432	1.800	.360	.384	#4-40 UNC THD		1.514	.540

PLUG: MK- 2F2-031-175-320S
RECEPTACLE: MM- 222-031-261-41WQ-900
 XX-XXX-XXX-XXX-XXXX-XXX

PLUG

RECEPTACLE

SERIES

MK .050" Rugged Metal Card Edge Mount Connector (MK mates with MK, ML, MM, MN receptacles)	MM .050" Rugged Metal I/O Connector (MM mates with MK, ML, MM, MN plugs)
--	--

BODY

2 2-Row (Sizes 9 thru 37)	2 2-Row (Sizes 9 thru 37)
3 3-Row (Size 51 & 69)	3 3-Row (Size 51 & 69)
4 4-Row (Size 100)	4 4-Row (Size 100)

BODY STYLE: F Plug, straight, card edge, with mounting brackets	BODY STYLE: 2 Receptacle, straight, with ears
---	---

BODY MATERIAL: 2 Polyphenylene Sulfide with electroless nickel shell	BODY MATERIAL: 2 Polyphenylene Sulfide with electroless nickel shell
3 Polyphenylene Sulfide with electrodeposited cadmium shell <input checked="" type="checkbox"/>	3 Polyphenylene Sulfide with electrodeposited cadmium shell <input checked="" type="checkbox"/>
4 Polyphenylene Sulfide with hard anodized black shell	4 Polyphenylene Sulfide with hard anodized black shell

SIZE

XXX 009, 015, 021, 025, 031, 037, 051, 069, 100	XXX 009, 015, 021, 025, 031, 037, 051, 069, 100
---	---

CONTACTS

TYPE CONTACTS/TERMINATIONS: 17 Pin, surface mount, .062-.094 pcb thickness (.010 dia)	TYPE CONTACTS/TERMINATIONS: 21 Socket, straight, solder cup
18 Pin, surface mount, .109-.140 pcb thickness (.010 dia)	24 Socket, straight, .500" pigtails (.018 dia)
	25 Socket, straight, 1.000" pigtails (.018 dia)
	26 Socket, straight, crimped wire

PLATING OPTIONS: 5 50 μ" Au contacts; Sn/Pb alloy terminations <input checked="" type="checkbox"/>	PLATING OPTIONS: 1 50 μ" Au contacts (crimp wire)
8 50 μ" Au contacts; Sn plated terminations	3 50 μ" Au contacts: 10 μ" Au terminations (solder cup, pigtail)
	5 50 μ" Au contacts; Sn/Pb alloy terminations (pigtail) <input checked="" type="checkbox"/>
	7 50 μ" Au contacts; SAC305 terminations (pigtail)

HARDWARE

STYLE OF HARDWARE: 32 Two fixed jacknut assemblies (72*)	STYLE OF HARDWARE: 00 None
46 Two turning jackscrews, allen head, captivated** (86*)	22 Two fixed jacknut assemblies (62*)
	41 Two turning jackscrews, allen head, retaining ring (81*)
	42 Two long turning jackscrews, allen head, retaining ring (82*)
	43 Two turning jackscrews, slot head, retaining ring (83*)
	44 Two long turning jackscrews, slot head, retaining ring (84*)
	45 Two turning jackscrews, allen head, captivated** (85*)

POLARIZATION / WIRING: 0S Standard Body Polarization	POLARIZATION / WIRING: 00 None
	XX For wiring codes, see page MA-3 & MA-4

OPTIONS

900 Interfacial sealing gasket

* = Use number in parenthesis when ordering size 100.
 ** = Captive hardware is factory installed and non-removable.
 = Option not RoHS compliant



Recommended PC Board Layout

Card Edge Mount
Standard Polarization

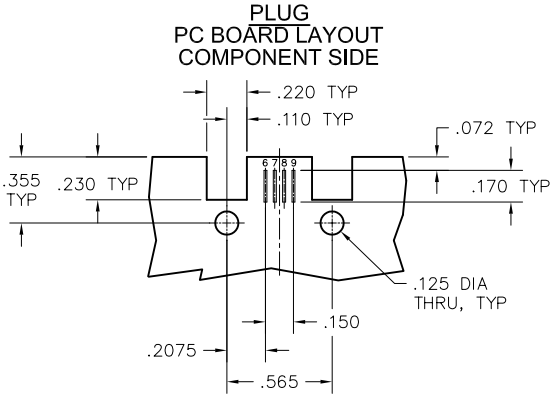
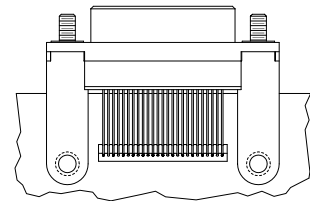
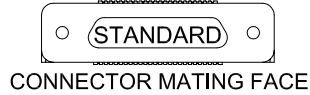
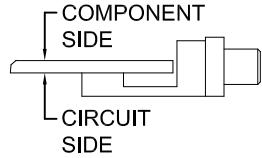

CONNECTOR MATING FACE

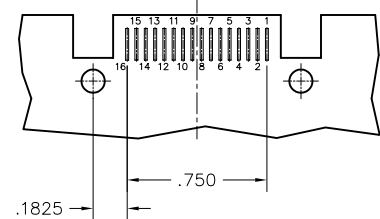
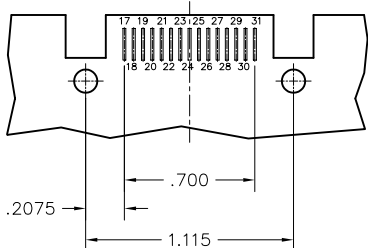
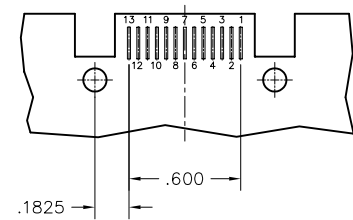
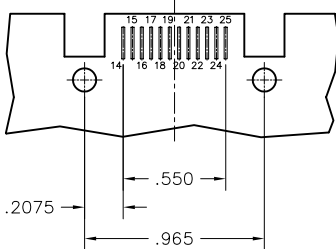
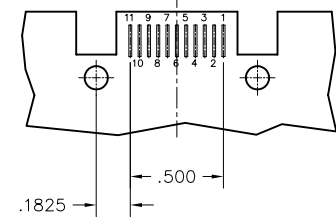
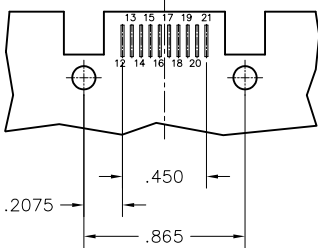
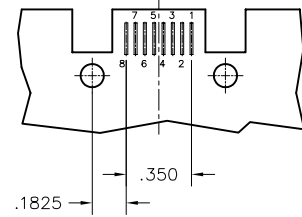
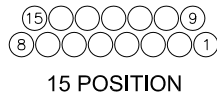
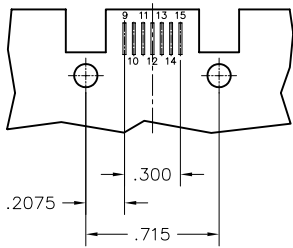
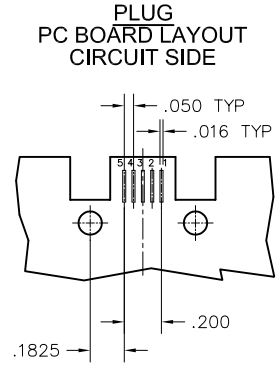
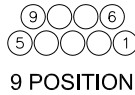

Recommended PC Board Layout

Card Edge Mount
Standard Polarization

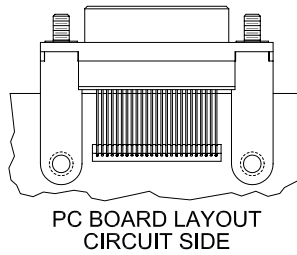
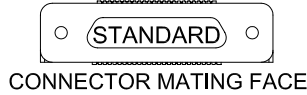
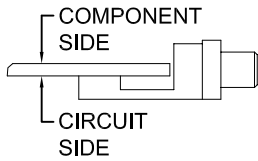

PLUG
PC BOARD LAYOUT
COMPONENT SIDE

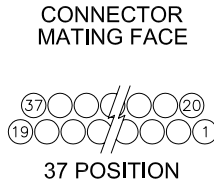
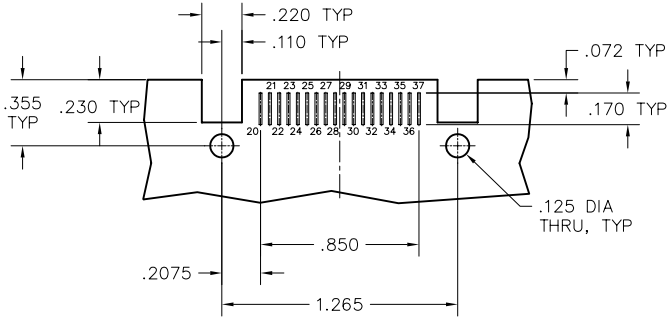

PLUG
PC BOARD LAYOUT
CIRCUIT SIDE

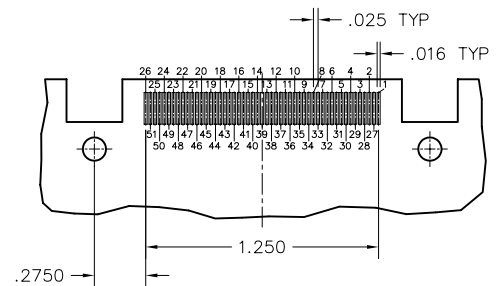
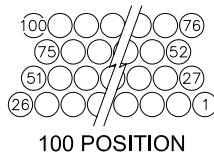
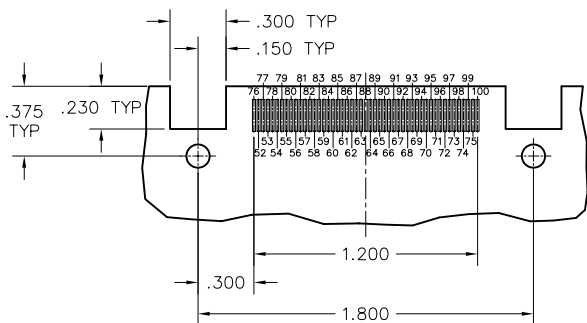
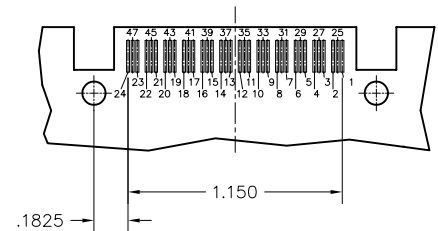
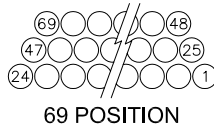
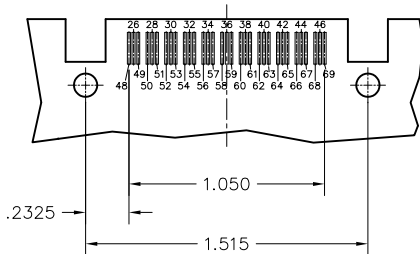
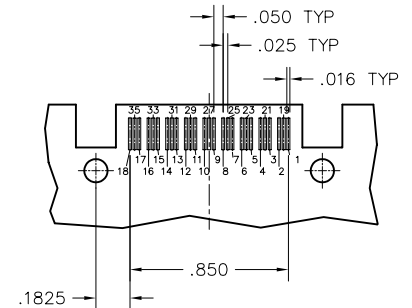
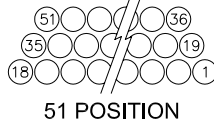
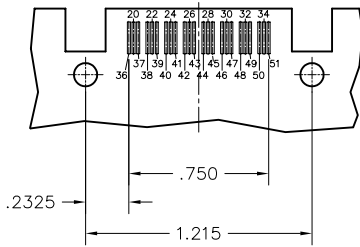
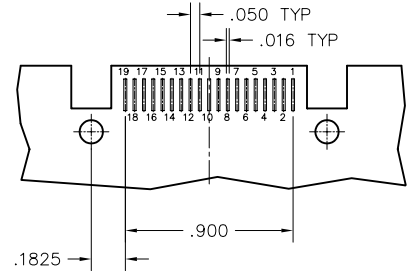



Recommended PC Board Layout

Card Edge Mount
Standard Polarization

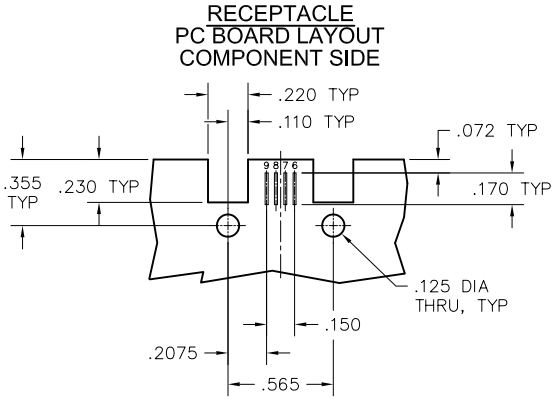
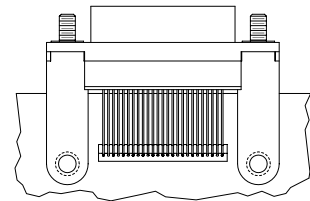
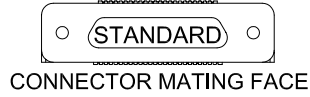
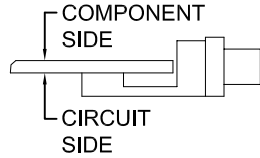

CONNECTOR
MATING FACE

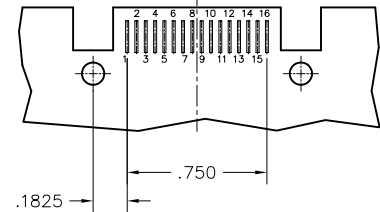
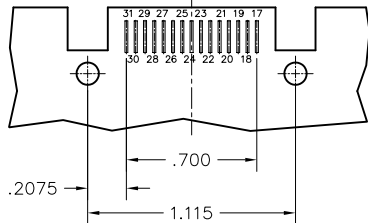
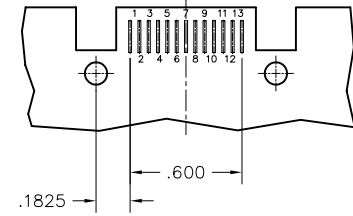
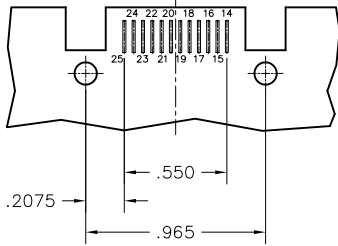
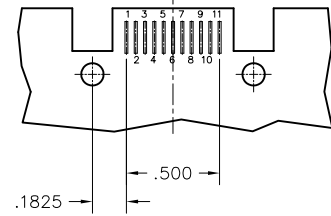
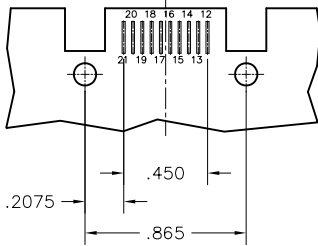
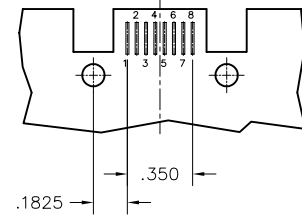
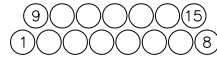
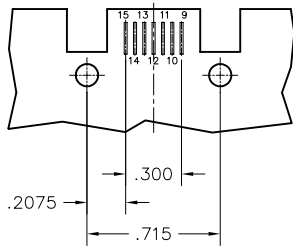
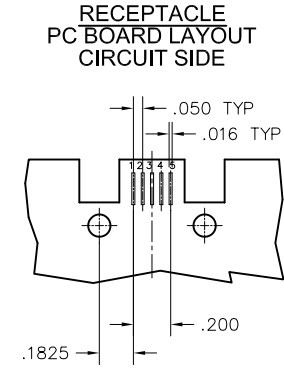

Recommended PC Board Layout

Card Edge Mount
Standard Polarization

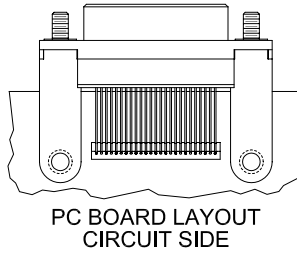
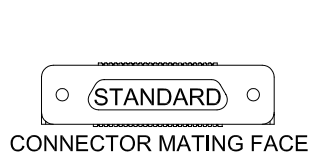
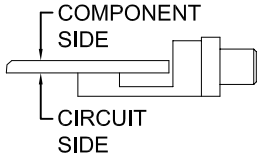

RECEPTACLE
PC BOARD LAYOUT
COMPONENT SIDE

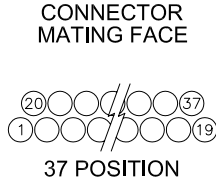
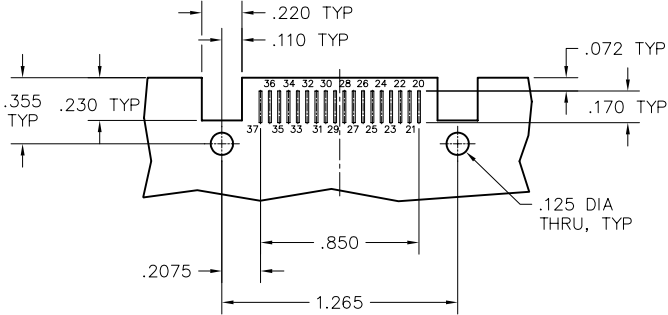

RECEPTACLE
PC BOARD LAYOUT
CIRCUIT SIDE

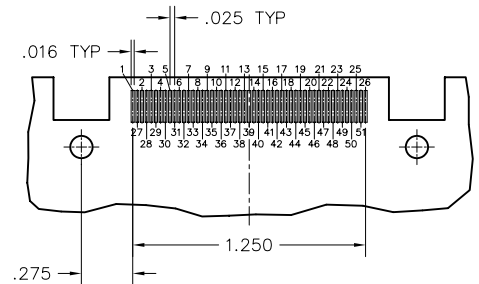
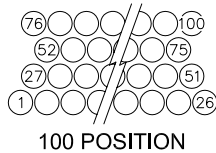
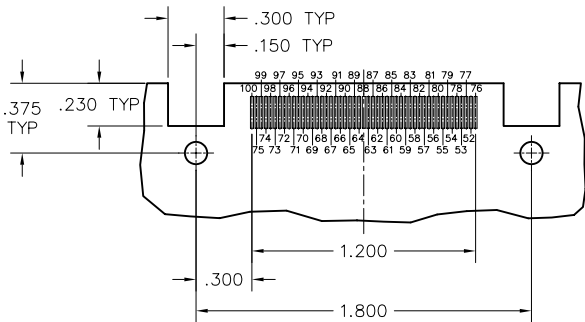
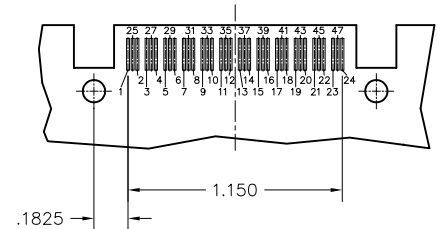
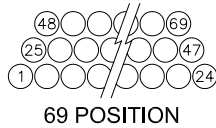
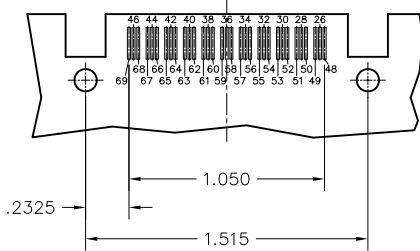
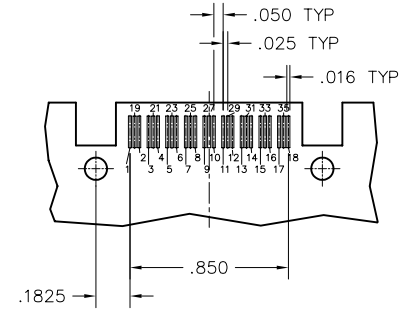
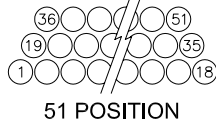
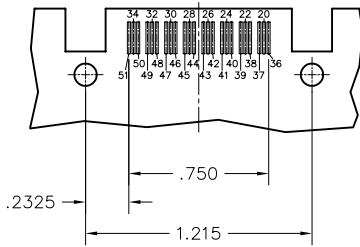
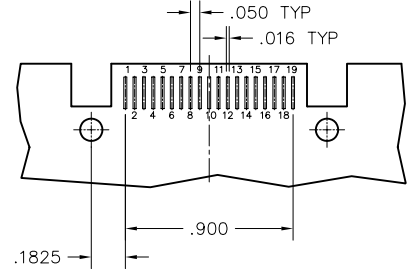

Filtered Cable Connectors

.050"

9 thru 37 Contacts

Rugged Metal

MF

Electrical Data

Dielectric Withstanding Voltage (DWV): 300 VDC
 Insulation Resistance: 5000 Megohms @ 100 VDC
 Working Voltage (WV): 100 VDC
 Current Rating: 3 Amps

Application Notes

1. Hipot voltage must not exceed working voltage.
2. Maximum solder tinning temperature is 275° C while maintaining a tinning dwell of 5 seconds max.
3. Maximum solder station temperature is 360° C while maintaining a soldering dwell of less than 5 seconds.
4. Temperature exceeding 150° C should never be applied to the entire connector. Failure to adhere to these guidelines may result in damage to connector or significantly reduced operating characteristics.

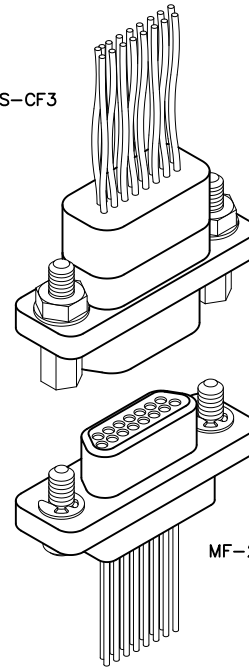

MF-212-015-145-4100-CF6

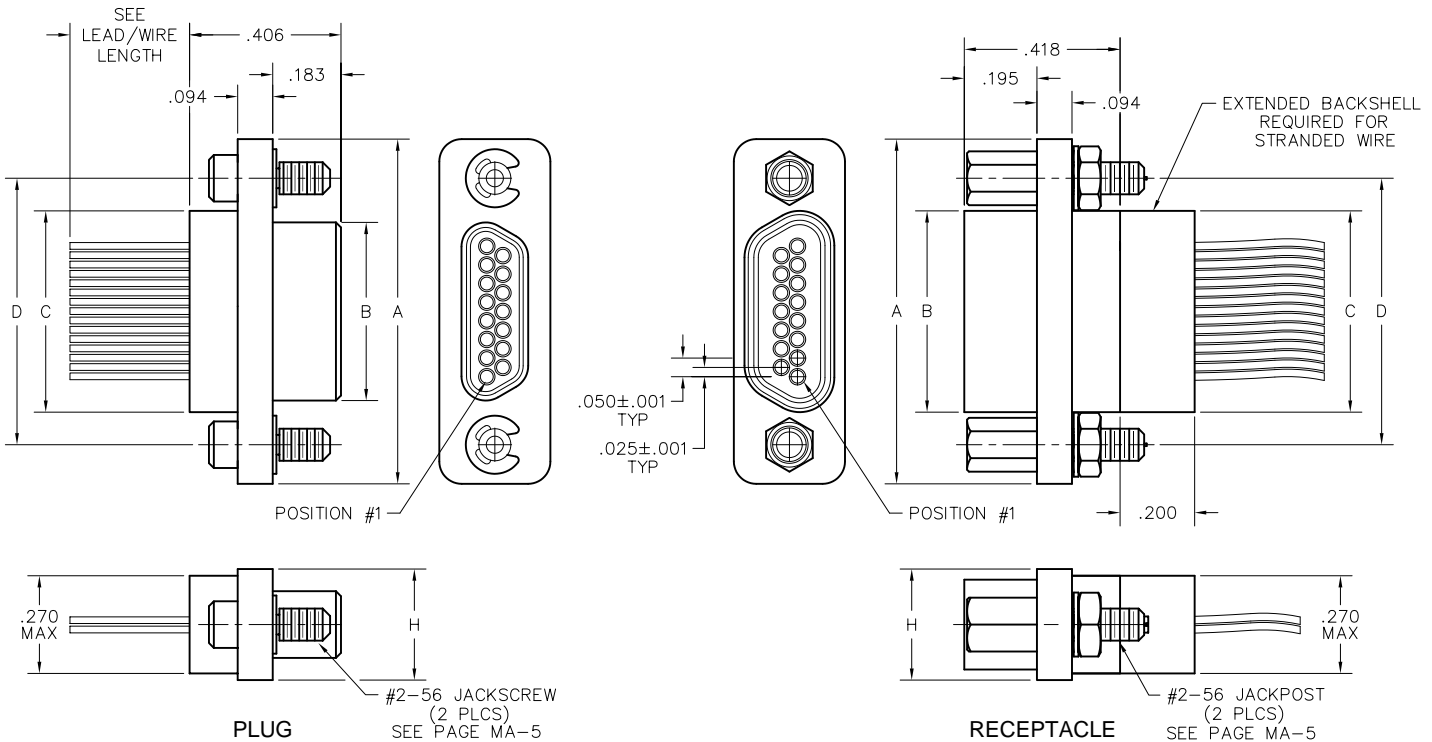

SIZE	CONTACT ROWS	DIMENSIONS					H	HARDWARE
		A	B		C	D		
			PLUG MAX	RCPT MAX				
9	2	.775	.334	.400	.390	.565	.298 #2-56 UNC THD (.092 DIA THRU)	
15		.925	.484	.550	.540	.715		
21		1.075	.634	.700	.690	.865		
25		1.175	.734	.800	.790	.965		
31		1.325	.884	.950	.940	1.115		
37		1.475	1.034	1.100	1.090	1.265		

Call (972) 931-3200 · Fax (972) 931-9305 · www.AirBorn.com

PLUG: MF-212-015-145-4100-CF6
RECEPTACLE: MM-222-031-2G3-4500
PLUG: MF-212-031-1G3-4500
RECEPTACLE: MF-222-015-261-22WS-CF3
 XX-XXX-XXX-XXX-XXXX-XXX

PLUG

RECEPTACLE

SERIES	
MF .050" Rugged Metal I/O Connector (MF mates with MK, ML, MM, MN receptacles)	MF .050" Rugged Metal I/O Connector (MF mates with MK, ML, MM, MN plugs)
BODY	
2 2-Row (Sizes 9 thru 37)	2 2-Row (Sizes 9 thru 37)
BODY STYLE: 1 Plug, straight, with ears	BODY STYLE: 2 Receptacle, straight, with ears & interfacial seal
BODY MATERIAL: 2 Polyphenylene Sulfide with electroless nickel shell 3 Polyphenylene Sulfide with electrodeposited cadmium shell <input checked="" type="checkbox"/>	BODY MATERIAL: 2 Polyphenylene Sulfide with electroless nickel shell 3 Polyphenylene Sulfide with electrodeposited cadmium shell <input checked="" type="checkbox"/>
SIZE	
XXX 009, 015, 021, 025, 031, 037	XXX 009, 015, 021, 025, 031, 037
CONTACTS	
TYPE CONTACTS/TERMINATIONS: 1D Pin, straight, .109" Lead Length (.018 dia) SEE NOTE 1 1E Pin, straight, .125" Lead Length (.018 dia) SEE NOTE 1 1F Pin, straight, .140" Lead Length (.018 dia) SEE NOTE 1 12 Pin, straight, .150" Lead Length (.018 dia) SEE NOTE 1 1G Pin, straight, .156" Lead Length (.018 dia) SEE NOTE 1 1H Pin, straight, .172" Lead Length (.018 dia) SEE NOTE 1 1J Pin, straight, .187" Lead Length (.018 dia) SEE NOTE 1 13 Pin, straight, .250" Lead Length (.018 dia) SEE NOTE 1 1K Pin, straight, .375" Lead Length (.018 dia) SEE NOTE 1 14 Pin, straight, .500" pigtailed (.018 dia) SEE NOTE 1 15 Pin, straight, 1.000" pigtailed (.018 dia) SEE NOTE 1 16 Pin, straight, stranded wire	TYPE CONTACTS/TERMINATIONS: 2D Socket, straight, .109" Lead Length (.018 dia) 2E Socket, straight, .125" Lead Length (.018 dia) 2F Socket, straight, .140" Lead Length (.018 dia) 22 Socket, straight, .150" Lead Length (.018 dia) 2G Socket, straight, .156" Lead Length (.018 dia) 2H Socket, straight, .172" Lead Length (.018 dia) 2J Socket, straight, .187" Lead Length (.018 dia) 23 Socket, straight, .250" Lead Length (.018 dia) 2K Socket, straight, .375" Lead Length (.018 dia) 2L Socket, straight, .500" Lead Length (.018 dia) 2M Socket, straight, 1.000" Lead Length (.018 dia) 24 Socket, straight, .500" pigtailed (.018 dia) SEE NOTE 1 25 Socket, straight, 1.000" pigtailed (.018 dia) SEE NOTE 1 26 Socket, straight, stranded wire
PLATING OPTIONS: 1 50 μ" Au contacts (stranded wire) <input checked="" type="checkbox"/> 3 50 μ" Au contacts; 10 μ" Au terminations (pigtailed) 5 50 μ" Au contacts; Sn/Pb alloy terminations (pigtailed) <input checked="" type="checkbox"/>	PLATING OPTIONS: 1 50 μ" Au contacts (stranded wire) <input checked="" type="checkbox"/> 3 50 μ" Au contacts; 10 μ" Au terminations (pigtailed) 5 50 μ" Au contacts; Sn/Pb alloy terminations (pigtailed) <input checked="" type="checkbox"/>
HARDWARE	
STYLE OF HARDWARE: 00 None 22 Two fixed jacknut assemblies 41 Two turning jackscrews, allen head, retaining ring 42 Two long turning jackscrews, allen head, retaining ring 43 Two turning jackscrews, slot head, retaining ring 44 Two long turning jackscrews, slot head, retaining ring 45 Two turning jackscrews, allen head, captivated**	STYLE OF HARDWARE: 00 None 22 Two fixed jacknut assemblies 41 Two turning jackscrews, allen head, retaining ring 42 Two long turning jackscrews, allen head, retaining ring 43 Two turning jackscrews, slot head, retaining ring 44 Two long turning jackscrews, slot head, retaining ring 45 Two turning jackscrews, allen head, captivated**
WIRING: 00 None XX For wiring codes, see page MA-3 & MA-4	WIRING: 00 None XX For wiring codes, see page MA-3 & MA-4
CAPACITOR DESIGNATOR	
XXX See tables below	XXX See tables below

** = Captive hardware is factory installed and non-removable.
 = Option not RoHS compliant

NOTE 1 = The leads on these contacts are soft copper suitable for forming.

CERAMIC CHIP CAPACITOR FILTERS

CAPACITOR DESIGNATOR	CAP RANGE (pF)	MINIMUM INSERTION LOSS (DECIBELS)			
		10 MHz	15 MHz	30 MHz	50 MHz
CF1 <input checked="" type="checkbox"/>	150-250	—	—	1	4
CF2 <input checked="" type="checkbox"/>	300-500	1	2	5	8
CF3 <input checked="" type="checkbox"/>	700-1000	3	5	10	10
CF4 <input checked="" type="checkbox"/>	1300-2000	6	10	15	20
CF5 <input checked="" type="checkbox"/>	4000-5400	13	15	20	27
CF6 <input checked="" type="checkbox"/>	8500-11500	18	20	25	30

PLANAR CAPACITOR FILTERS

CAPACITOR DESIGNATOR	CAP RANGE (pF)	MINIMUM INSERTION LOSS (DECIBELS)			
		10 MHz	100 MHz	500 MHz	1 GHz
PF1 <input checked="" type="checkbox"/>	150-250	—	8	33	36
PF2 <input checked="" type="checkbox"/>	300-500	—	13	37	44
PF3 <input checked="" type="checkbox"/>	700-1000	2	19	42	42
PF4 <input checked="" type="checkbox"/>	1300-2000	6	25	45	45
PF5 <input checked="" type="checkbox"/>	4000-5400	14	34	41	41
PF6 <input checked="" type="checkbox"/>	8500-11500	20	36	43	43

Minimum no load attenuation (in 50 Ohm system, 25° C)

Specifications - Hybrid Connectors

Materials and Finishes *

Contacts:	Pins: BeCu alloy strip per ASTM B194 Sockets: Brass per ASTM B121 / B121M or ASTM B16 / B16M or ASTM B453 Power: Copper based alloy selected for power applications
Contact Finish:	Gold plate per ASTM B488
Shells:	Aluminum Alloy 6061-T6 per SAE AMS-QQ-A-250/11 or 6061-T6511 per SAE AMS-QQ-A-200/8
Aluminum Shell Finishes:	Electroless Nickel per SAE AMS2404, Class 3, 500 μ " min Electrodeposited Cadmium per SAE AMS-QQ-P-416, Type II, Class 3
Molded Insulators:	Glass filled polyphenylene sulfide per MIL-M-24519
Embedment:	Frey Engineering Co. insulating compound CF3003-80 and L-II-49 or equivalent
Jackscrews, Jackposts and Nuts:	Corrosion resistant steel per ASTM A320 or ASTM A484 / A484M and ASTM A582 / A582 Passivated per SAE AMS2700
Clips and Washers:	Corrosion resistant steel per ASME 18.24 or NASM35333 (For reference only: ASME 18.24 CRS per ASTM A693 and NASM35333 CRS per ASTM A240) Passivated per ASME 18.24 or NASM35333 (For reference only: ASME 18.24 and NASM35333 passivated per SAE AMS2700)
Interfacial Seal Gaskets:	Fluorosilicone per SAE AMS-R-25988
Tolerances:	Unless otherwise specified: Fractions = $\pm 1/64$ " Decimals = ± 0.10 " Angles = $\pm 5^\circ$ Wire lengths: insulated/stranded = $+1.0"/-0.0$ "

Note: AirBorn can manufacture special configurations for your exact specifications.

* = Reference the above listed specifications or an equivalent industry standard when applicable

Performance - Hybrid Connectors

Reference MIL-DTL-83513

Contact Rating:	3-amperes maximum for signal and coax contacts 13-amperes maximum for power contacts
Solderability:	Terminals (except crimp) tested in accordance with MIL-STD-202, Method 208
Wire Size:	Stranded #16 AWG standard for power contacts RG316 or RG178 standard for coax contacts Stranded #24-#28 AWG standard (consult factory for other sizes and types)
Test Voltage:	600 V, RMS, 60 Hz
Operating Temperature:	-55° C to +125° C
Insulation Resistance:	5,000 megohms minimum @ 500 VDC
Durability:	500 connector mating cycles
Vibration:	Tested in accordance with MIL-STD-1344, Method 2005, Condition IV, according to MIL-83513
Shock:	Tested in accordance with MIL-STD-1344, Method 2004, Condition E, according to MIL-83513
Salt Spray:	Mated connectors tested in accordance with MIL-STD-1344, Method 1001, Test Condition B
Humidity:	Mated connectors tested in accordance with MIL-STD-1344, Method 1002, Type II (except steps 7a and 7b)
Thermal Shock:	Tested to the temperature extremes of MIL-STD-1344, Method 1003, Test Condition A (except step 3, temperature shall be 125° C)



Cable to Cable Hybrid

.050"

7 or 24 Contacts

Rugged Metal

MM

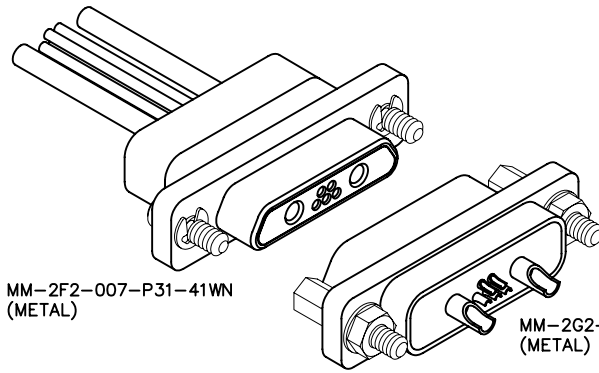

MM-2F2-007-P31-41WN
(METAL)

MM-2G2-007-P23-2200
(METAL)

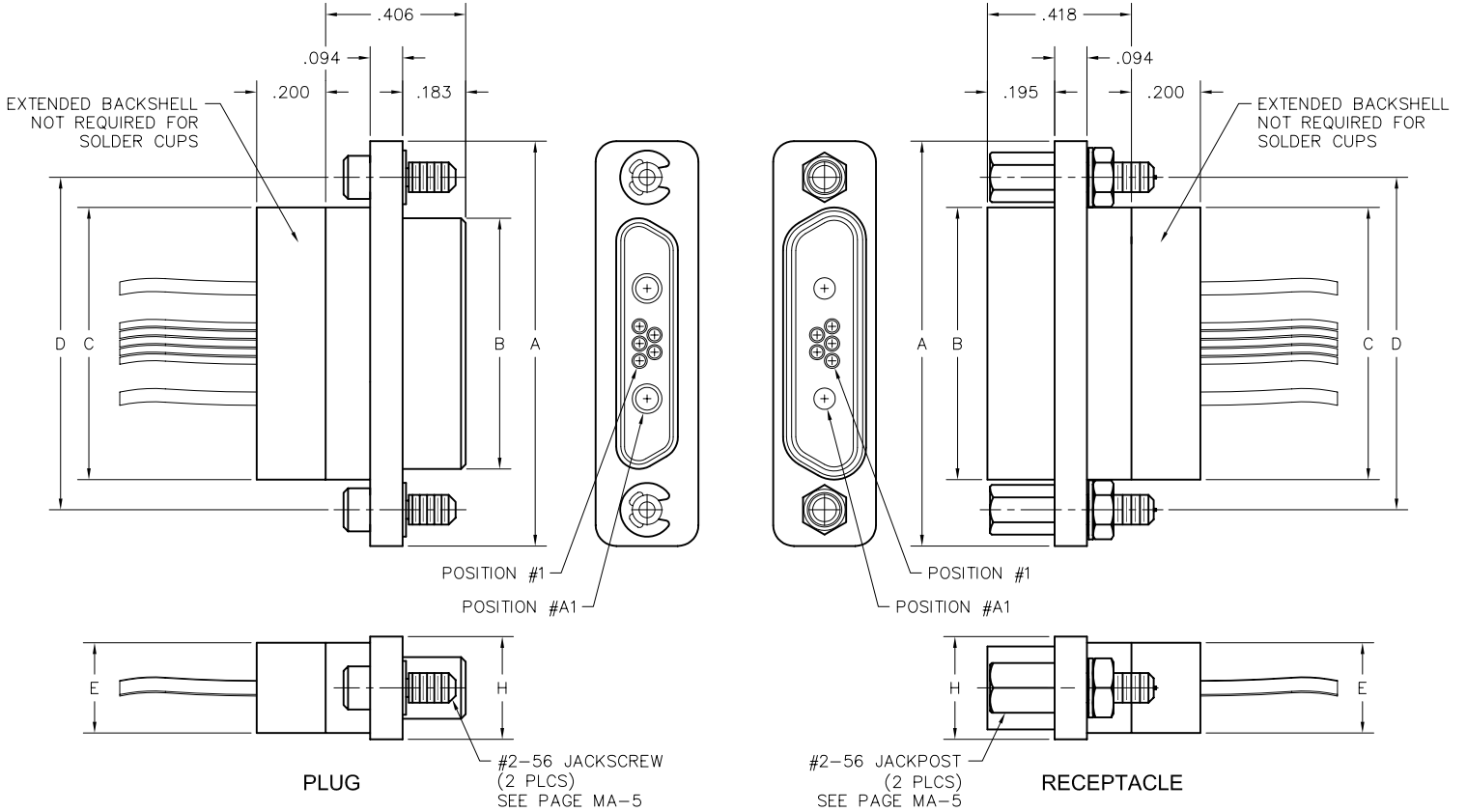

DIMENSIONS									
SIZE	CONTACT ROWS	A	B		C	D	E POTTING WELL MAX	H	HARDWARE
			PLUG MAX	RCPT MAX					
7	2	1.175	.734	.800	.790	.965	.270	.298	#2-56 UNC THD (.092 DIA THRU)
24	3	1.425	.984	1.050	1.040	1.215	.310	.341	

INTERFACE DIMENSIONS

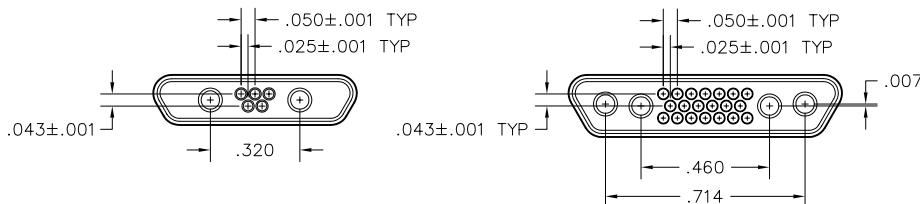

Call (972) 931-3200 · Fax (972) 931-9305 · www.AirBorn.com

PLUG: MM-2F2-007-P31-41WN
RECEPTACLE: MM-2G2-007-P41-22WS
 XX-XXX-XXX-XXX-XXXX

PLUG

RECEPTACLE

SERIES	
MM .050" Rugged Metal Connector	MM .050" Rugged Metal Connector
BODY	
2 2-Row (Size 7)	2 2-Row (Size 7)
3 3-Row (Size 24)	3 3-Row (Size 24)
BODY STYLE: F Plug, straight, with ears	BODY STYLE: G Receptacle, straight, with ears & interfacial seal
BODY MATERIAL: 2 Polyphenylene Sulfide with electroless nickel shell 3 Polyphenylene Sulfide with electrodeposited cadmium shell <input checked="" type="checkbox"/>	BODY MATERIAL: 2 Polyphenylene Sulfide with electroless nickel shell 3 Polyphenylene Sulfide with electrodeposited cadmium shell <input checked="" type="checkbox"/>
SIZE	
007 2 Power or Coax and 5 Signal	007 2 Power or Coax and 5 Signal
024 4 Power or Coax and 20 Signal	024 4 Power or Coax and 20 Signal
CONTACTS	
TYPE CONTACTS/TERMINATIONS: P1 Solder cup, power connector P3 Crimped wire, Power contacts M16878/4-16-9, length per wire code. C3 Crimped wire, Coax RG316, length per wire code C5 Crimped wire, Coax RG178, length per wire code Note: Plug connector has pin signal contacts and socket power/coax contacts.	TYPE CONTACTS/TERMINATIONS: P2 Solder cup, power connector P4 Crimped wire, Power contacts M16878/4-16-9, length per wire code. C4 Crimped wire, Coax RG316, length per wire code C6 Crimped wire, Coax RG178, length per wire code Note: Receptacle connector has socket signal contacts and pin power/coax contacts.
PLATING OPTIONS: 1 50 μ" Au contacts (crimp wire) 3 50 μ" Au contacts: 10 μ" Au terminations (solder cup, power connectors only)	PLATING OPTIONS: 1 50 μ" Au contacts (crimp wire) 3 50 μ" Au contacts: 10 μ" Au terminations (solder cup, power connectors only)
HARDWARE	
STYLE OF HARDWARE: 00 None 22 Two fixed jacknut assemblies 41 Two turning jackscrews, allen head, retaining ring 42 Two long turning jackscrews, allen head, retaining ring 43 Two turning jackscrews, slot head, retaining ring 44 Two long turning jackscrews, slot head, retaining ring 45 Two turning jackscrews, allen head, captivated**	STYLE OF HARDWARE: 00 None 22 Two fixed jacknut assemblies 41 Two turning jackscrews, allen head, retaining ring 42 Two long turning jackscrews, allen head, retaining ring 43 Two turning jackscrews, slot head, retaining ring 44 Two long turning jackscrews, slot head, retaining ring 45 Two turning jackscrews, allen head, captivated**
WIRING: 00 None XX For wiring codes, see page MA-3 & MA-4	WIRING: 00 None XX For wiring codes, see page MA-3 & MA-4

** = Captive hardware is factory installed and non-removable.

= Option not RoHS compliant

Circular Cable Connectors

.050"

7 & 19 Contacts

Rugged Metal

MC

MC-111-007-161-00WN

MC-121-007-261-00WN

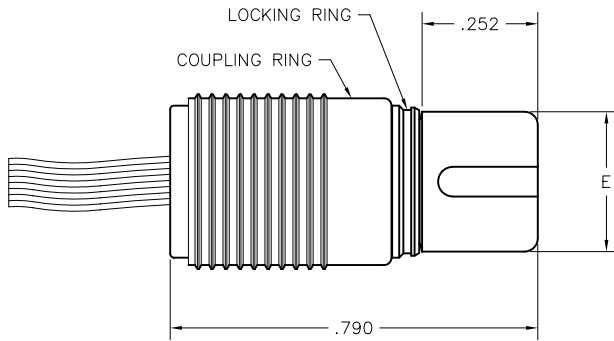
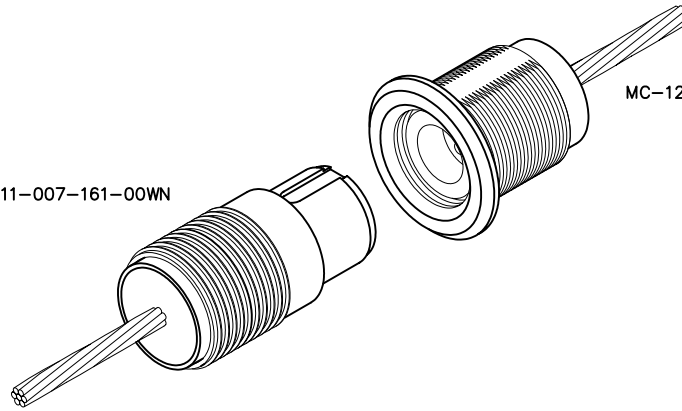

PLUG
(Socket Contacts)

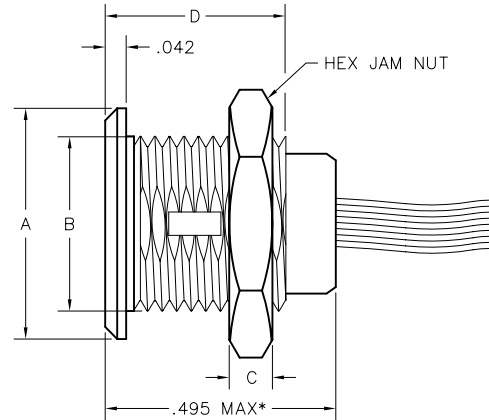

RECEPTACLE
FRONT PANEL MOUNT
(Pin Contacts)

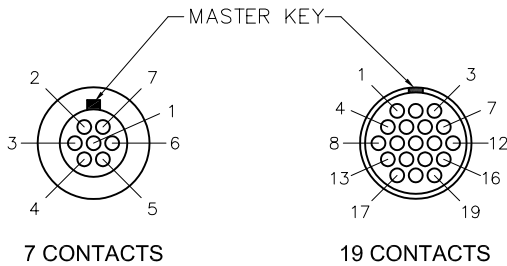

7 CONTACTS

19 CONTACTS

Contact Arrangements

Face view, receptacle (Pin contacts)
Cavity identification numbers are for reference
and do not appear on connector.

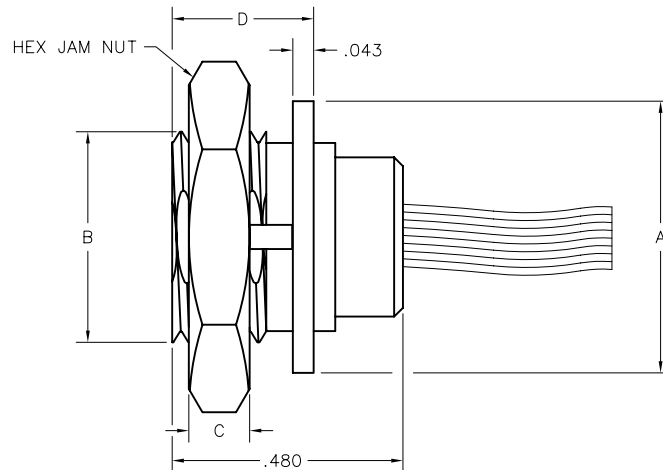

RECEPTACLE
REAR PANEL MOUNT
(Pin Contacts)

DIMENSIONS (RECEPTACLE)					
MOUNT	BODY	A MAX DIA	B THREAD	C NUT	D
FRONT PANEL	1 (7 POS)	.510	3/8-32 UNEF-2A	.093	.388
FRONT PANEL	2 (19 POS)	.575	1/2-28 UNEF-2A	.125	.340
REAR PANEL	1 (7 POS)	.575	7/16-28 UNEF-2A	.093	.293
REAR PANEL	2 (19 POS)	.575	1/2-28 UNEF-2A	.125	.305

DIMENSIONS (PLUG)	
BODY	E MAX DIA
1 (7 POS)	.305
2 (19 POS)	.405

* = .530 MAX FOR SOLDER CUP CONNECTORS

PLUG: MC- 111-007- 161-00WN
RECEPTACLE: MC- 121-007- 261-00WN
 XX-XXX-XXX-XXX-XXXX

PLUG		RECEPTACLE	
SERIES			
MC .050" Circular Connector		MC .050" Circular Connector	
BODY			
1 7 position shell	1 7 position shell	2 19 position shell	2 19 position shell
BODY STYLE:		BODY STYLE:	
1 Quick disconnect	2 Front mount, quick disconnect	4 Rear mount, quick disconnect	
BODY MATERIAL:		BODY MATERIAL:	
1 Polyphenylene Sulfide insulator, brass shell with electroless nickel plating	1 Polyphenylene Sulfide insulator, brass shell with electroless nickel plating		
SIZE			
XXX 007, 019		XXX 007, 019	
CONTACTS			
TYPE CONTACTS/TERMINATIONS:		TYPE CONTACTS/TERMINATIONS:	
14 Socket, straight, .500" pigtails (.018 dia)	21 Pin, straight, solder cup	24 Pin, straight, .500" pigtails (.018 dia)	
15 Socket, straight, 1.000" pigtails (.018 dia)	25 Pin, straight, 1.000" pigtails (.018 dia)	26 Pin, straight, crimped wire	
16 Socket, straight, crimped wire			
PLATING OPTIONS:		PLATING OPTIONS:	
1 50 μ" Au contacts (crimp wire)	1 50 μ" Au contacts (crimp wire)	3 50 μ" Au contacts: 10 μ" Au terminations (pigtail)	
3 50 μ" Au contacts: 10 μ" Au terminations (pigtail)	3 50 μ" Au contacts: 10 μ" Au terminations (solder cup, pigtail)	5 50 μ" Au contacts; Sn/Pb alloy terminations (pigtail) ☒	
5 50 μ" Au contacts; Sn/Pb alloy terminations (pigtail) ☒	7 50 μ" Au contacts; SAC305 terminations (pigtail)		
7 50 μ" Au contacts; SAC305 terminations (pigtail)			
HARDWARE			
STYLE OF HARDWARE:		STYLE OF HARDWARE:	
00 None	00 None		
POLARIZATION / WIRING:		POLARIZATION / WIRING	
00 None	00 None	XX For wiring codes, see page MA-3 & MA-4	
XX For wiring codes, see page MA-3 & MA-4			

☒ = Option not RoHS compliant

PANEL MOUNTING DIMENSIONS

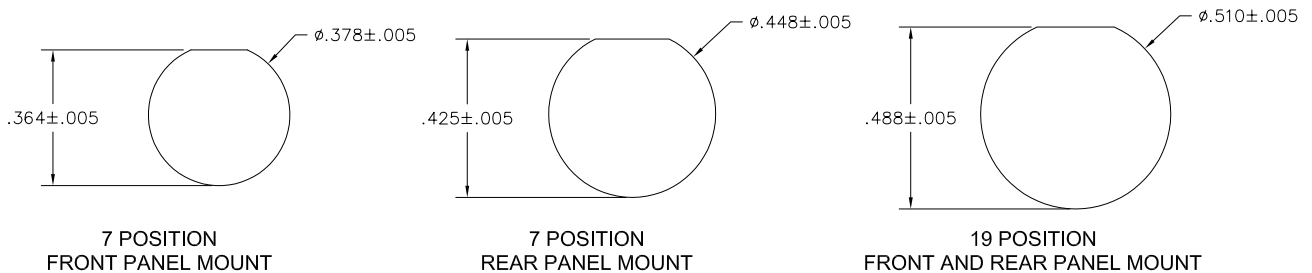

Specifications - Rear Panel Mount Connectors

Materials and Finishes *

Contacts:	Pins: BeCu alloy strip per ASTM B194 Sockets: Brass per ASTM B121 / B121M or ASTM B453
Contact Finish:	Gold plate per ASTM B488
Shells:	Aluminum Alloy 6061-T6 per SAE AMS-QQ-A-250/11 or 6061-T6511 per SAE AMS-QQ-A-200/8
Aluminum Shell Finishes:	Electroless Nickel per SAE AMS2404, Class 3, 500 μ " min Electrodeposited Cadmium per SAE AMS-QQ-P-416, Type II, Class 3 Black Anodized per MIL-A-8625, Type III, Class 2
Molded Insulators:	Glass filled polyphenylene sulfide per MIL-M-24519
Embedment:	Frey Engineering Co. insulating compound CF3003-80 and L-II-49 or equivalent
Jackscrews, Jackposts and Nuts:	Corrosion resistant steel per ASTM A320 or ASTM A484 / A484M and ASTM A582 / A582M Passivated per SAE AMS2700
Clips:	Corrosion resistant steel per ASME 18.24 (For reference only: ASME 18.24 CRS per ASTM A693) Passivated per ASME 18.24 (For reference only: ASME 18.24 passivated per SAE AMS2700)
Gaskets:	Interfacial: Fluorosilicone per SAE AMS-R-25988 Flange: Fluorosilicone per SAE AMS-R-25988 Flange EMI: Conductive Elastomer per MIL-DTL-83528, Type D
Tolerances:	Unless otherwise specified: Fractions = $\pm 1/64$ " Decimals = $\pm .010$ " Angles = $\pm 5^\circ$ Wire lengths: insulated/stranded = $+1.0"/-0.0$ " uninsulated/solid = $+0.2"/-0.0$ "

Note: AirBorn can manufacture special configurations for your exact specifications.

* = Reference the above listed specifications or an equivalent industry standard when applicable

Performance - Rear Panel Mount Connectors

Contact Rating:	3-amperes maximum
Solderability:	Terminals (except crimp) tested in accordance with MIL-STD-202, Method 208
Wire Size:	Stranded #26 AWG or solid #25 AWG standard (consult factory for other sizes and types)
Test Voltage:	600 V, RMS, 60 Hz
Operating Temperature:	-55° C to +125° C
Insulation Resistance:	5,000 megohms minimum @ 500 VDC
Durability:	500 connector mating cycles
Vibration:	Tested in accordance with MIL-STD-1344, Method 2005, Condition IV, according to MIL-83513
Shock:	Tested in accordance with MIL-STD-1344, Method 2004, Condition E, according to MIL-83513
Salt Spray:	Mated connectors tested in accordance with MIL-STD-1344, Method 1001, Test Condition B
Humidity:	Mated connectors tested in accordance with MIL-STD-1344, Method 1002, Type II (except steps 7a and 7b)
Thermal Shock:	Tested to the temperature extremes of MIL-STD-1344, Method 1003, Test Condition A (except step 3, temperature shall be 125° C)
Contact Resistance:	0.065 volt maximum drop @ 2.5 amps (.026 ohms)
Contact Engaging Force:	6.0 ounce maximum, with .0221 diameter test sleeve
Contact Separating Force:	0.5 ounce minimum, with .0230 diameter test sleeve
Crimp Strength:	5 pound minimum tensile strength
Sealing:	When mated, AirBorn rear panel mount connectors provide an environmental seal to water, moisture and certain chemicals as well as a dust and dirt barrier.

Cable to Cable (Rear Panel Mount)

.050"

9 thru 100 Contacts

Rugged Metal

MM

Rugged Plastic

MN

MM-212-031-161-41WQ
(METAL)

MN-211-031-161-41WQ
(PLASTIC)

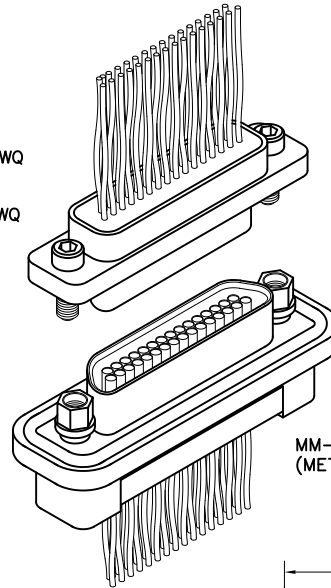

MM-2C2-031-261-26WA-EMI
(METAL)

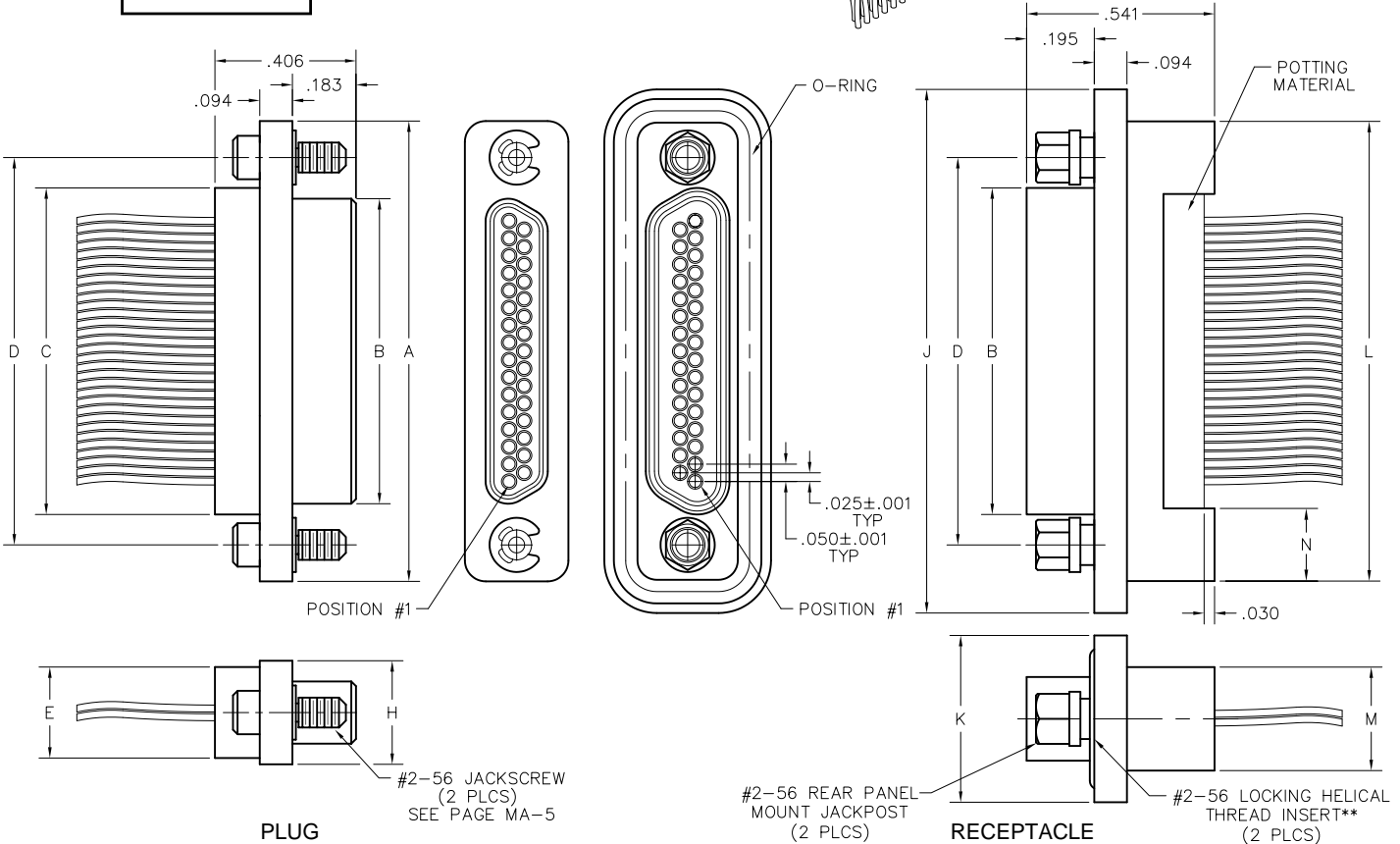

SIZE	CONTACT ROWS	DIMENSIONS												
		A	B		C	D	E	H	HARDWARE	J	K	L	M	N
			PLUG MAX	RCPT MAX			POTTING WELL MAX							
9	2	.775	.334	.400	.390	.565	.270	.298	#2-56 UNC THD	.957	.480	.773	.298	.210
15		.925	.484	.550	.540	.715				1.107		.923		
21		1.075	.634	.700	.690	.865				1.257		1.073		
25		1.175	.734	.800	.790	.965				1.357		1.173		
31		1.325	.884	.950	.940	1.115				1.507		1.323		
37	1.475	1.034	1.100	1.090	1.265	1.657	1.473							
51	3	1.425	.984	1.050	1.040	1.215	.310	.341	1.657	.523	1.477	.440	.239	
69*		1.725	1.284	1.350	1.340	1.515			1.957		1.777			
100		2.160	1.384	1.508	1.432	1.800			.360		.384			#4-40 UNC THD

* = 69 POSITION CONNECTORS ARE AVAILABLE IN METAL ONLY.

** = SHELL ACCEPTS .200 MAX #2-56 SCREW LENGTH (.295 MAX #4-40 SCREW LENGTH).

PLUG: MM-212-031-161-41WQ
RECEPTACLE: MM-2C2-031-261-26WA-EMI
PLUG: MN-211-031-161-41WQ
RECEPTACLE: MM-2C2-031-261-26WA-EMI
 XX-XXX-XXX-XXX-XXXX-XXX

PLUG

RECEPTACLE

SERIES

MM .050" Rugged Metal I/O Connector MN .050" Rugged Plastic I/O Connector (MM & MN mate with MK, ML, MM, MN receptacles)	MM .050" Rugged Metal I/O Connector (MM mates with MK, ML, MM, MN plugs)
--	---

BODY

2 2-Row (Sizes 9 thru 37) 3 3-Row (Size 51 or 69) 4 4-Row (Size 100)	2 2-Row (Sizes 9 thru 37) 3 3-Row (Size 51 or 69) 4 4-Row (Size 100)
--	--

BODY STYLE: 1 Plug, straight, with ears	BODY STYLE: C Receptacle, straight, rear panel mount, with fluorosilicone o-ring and interfacial seal
---	---

BODY MATERIAL: 1 Polyphenylene Sulfide (MN only) 2 Polyphenylene Sulfide with electroless nickel shell 3 Polyphenylene Sulfide with electrodeposited cadmium shell <input checked="" type="checkbox"/> 4 Polyphenylene Sulfide with hard anodized black shell	BODY MATERIAL: 2 Polyphenylene Sulfide with electroless nickel shell 3 Polyphenylene Sulfide with electrodeposited cadmium shell <input checked="" type="checkbox"/> 4 Polyphenylene Sulfide with hard anodized black shell
--	---

SIZE

XXX 009, 015, 021, 025, 031, 037, 051, 069, 100	XXX 009, 015, 021, 025, 031, 037, 051, 069, 100
---	---

CONTACTS

TYPE CONTACTS/TERMINATIONS: 11 Pin, straight, 26 awg solder cup 1A Pin, straight, 24 awg solder cup 14 Pin, straight, .500" pigtails (.018 dia) 15 Pin, straight, 1.000" pigtails (.018 dia) 16 Pin, straight, crimped wire	TYPE CONTACTS/TERMINATIONS: 21 Socket, straight, 26 awg solder cup 2A Socket, straight, 24 awg solder cup 24 Socket, straight, .500" pigtails (.018 dia) 25 Socket, straight, 1.000" pigtails (.018 dia) 26 Socket, straight, crimped wire
---	--

PLATING OPTIONS: 1 50 μ" Au contacts (crimp wire) 3 50 μ" Au contacts: 10 μ" Au terminations (solder cup, pigtail) 5 50 μ" Au contacts; Sn/Pb alloy terminations (pigtail) <input checked="" type="checkbox"/> 7 50 μ" Au contacts; SAC305 terminations (pigtail)	PLATING OPTIONS: 1 50 μ" Au contacts (crimp wire) 3 50 μ" Au contacts: 10 μ" Au terminations (solder cup, pigtail) 5 50 μ" Au contacts; Sn/Pb alloy terminations (pigtail) <input checked="" type="checkbox"/> 7 50 μ" Au contacts; SAC305 terminations (pigtail)
--	--

HARDWARE

STYLE OF HARDWARE: 00 None 41 Two turning jackscrews, allen head, retaining ring (81*) 42 Two long turning jackscrews, allen head, retaining ring (82*) 43 Two turning jackscrews, slot head, retaining ring (83*) 44 Two long turning jackscrews, slot head, retaining ring (84*) 45 Two turning jackscrews, allen head, captivated** (85*)	STYLE OF HARDWARE: 00 None 24 Two fixed jacknuts, rear panel mount, .040" panel thickness (64*) 26 Two fixed jacknuts, rear panel mount, .060" panel thickness (66*) 28 Two fixed jacknuts, rear panel mount, .070" panel thickness (68*) 29 Two fixed jacknuts, rear panel mount, .080" panel thickness (69*)
---	--

POLARIZATION / WIRING: 00 None XX For wiring codes, see page MA-3 & MA-4	POLARIZATION / WIRING 00 None XX For wiring codes, see page MA-3 & MA-4
---	--

OPTIONS

EMI EMI o-ring (in lieu of fluorosilicone o-ring)

* = Use number in parenthesis when ordering size 100.
 ** = Captive hardware is factory installed and non-removable.
 = Option not RoHS compliant



Cable to Cable (Rear Panel Mount)

.050"

9 thru 100 Contacts

Rugged Metal

MM

Rugged Plastic

MN

MM-222-031-2A3-2200
(METAL)

MN-221-031-2A3-2200
(PLASTIC)

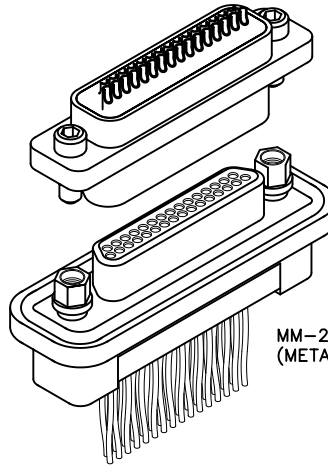

MM-2A2-031-161-26WA-EMI
(METAL)

3 AND 4 ROW SOLDER CUPS

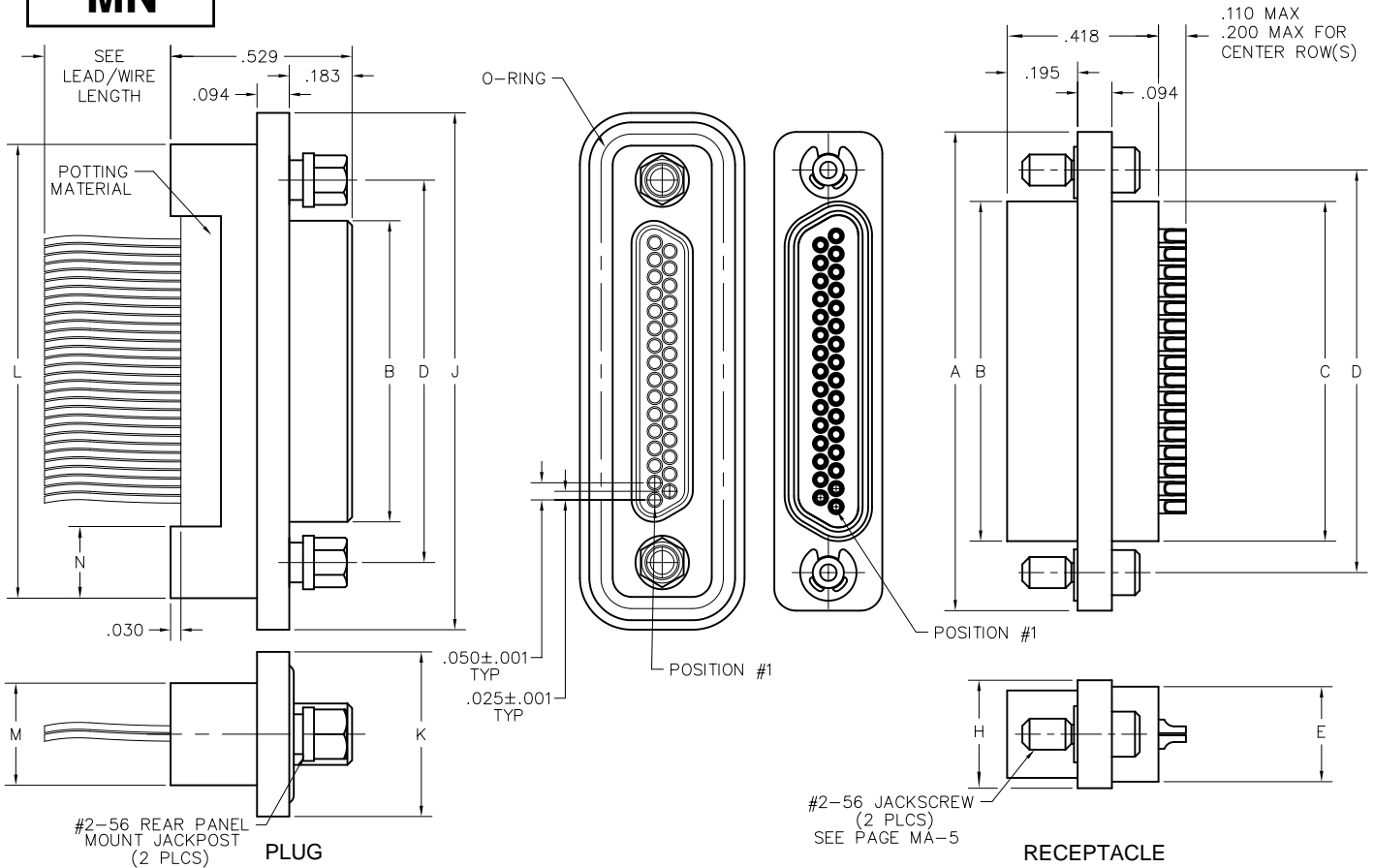

#2-56 REAR PANEL
MOUNT JACKPOST
(2 PLCS)

PLUG

#2-56 JACKSCREW
(2 PLCS)
SEE PAGE MA-5

RECEPTACLE

SIZE	CONTACT ROWS	DIMENSIONS												
		A	B		C	D	E	H	HARDWARE	J	K	L	M	N
		PLUG MAX	RCPT MAX			POTTING WELL MAX								
9	2	.775	.334	.400	.390	.565	.270	.298	#2-56 UNC THD (.092 DIA THRU)	.957	.480	.773	.298	.210
15		.925	.484	.550	.540	.715				1.107		.923		
21		1.075	.634	.700	.690	.865				1.257		1.073		
25		1.175	.734	.800	.790	.965				1.357		1.173		
31		1.325	.884	.950	.940	1.115				1.507		1.323		
37	1.475	1.034	1.100	1.090	1.265	1.657	1.473							
51	3	1.425	.984	1.050	1.040	1.215	.310	.341		1.657	.523	1.477	.440	.239
69*		1.725	1.284	1.350	1.340	1.515				1.957		1.777		
100	4	2.160	1.384	1.508	1.432	1.800	.360	.384	#4-40 UNC THD (.147 DIA THRU)	2.383	.600	2.219	.515	.301

* = 69 POSITON CONNECTORS ARE AVAILABLE IN METAL ONLY.

PLUG: MM-2A2-031-161-26WA-EMI
RECEPTACLE: MM-222-031-2G3-4500
PLUG: MN-2A2-031-161-26WA-EMI
RECEPTACLE: MN-221-031-2G3-4500
 XX-XXX-XXX-XXX-XXXX-XXX

PLUG		RECEPTACLE	
SERIES			
MM .050" Rugged Metal I/O Connector (MM mateS with MK, ML, MM, MN receptacles)	MM .050" Rugged Metal I/O Connector MN .050" Rugged Plastic I/O Connector (MM & MN mate with MK, ML, MM, MN plugs)		
BODY			
2 2-Row (Sizes 9 thru 37) 3 3-Row (Size 51 & 69) 4 4-Row (Size 100)	2 2-Row (Sizes 9 thru 37) 3 3-Row (Size 51 & 69) 4 4-Row (Size 100)		
BODY STYLE: A Plug, straight, rear panel mount, with fluorosilicone o-ring	BODY STYLE: 2 Receptacle, straight, with ears		
BODY MATERIAL: 2 Polyphenylene Sulfide with electroless nickel shell 3 Polyphenylene Sulfide with electrodeposited cadmium shell <input checked="" type="checkbox"/> 4 Polyphenylene Sulfide with hard anodized black shell	BODY MATERIAL: 1 Polyphenylene Sulfide (MN only) 2 Polyphenylene Sulfide with electroless nickel shell 3 Polyphenylene Sulfide with electrodeposited cadmium shell <input checked="" type="checkbox"/> 4 Polyphenylene Sulfide with hard anodized black shell		
SIZE			
XXX 009, 015, 021, 025, 031, 037, 051, 069, 100	XXX 009, 015, 021, 025, 031, 037, 051, 069, 100		
CONTACTS			
TYPE CONTACTS/TERMINATIONS: 11 Pin, straight, 26 awg solder cup 1A Pin, straight, 24 awg solder cup 1D Pin, straight, .109" Lead Length (.018 dia) SEE NOTE 1 1E Pin, straight, .125" Lead Length (.018 dia) SEE NOTE 1 1F Pin, straight, .140" Lead Length (.018 dia) SEE NOTE 1 12 Pin, straight, .150" Lead Length (.018 dia) SEE NOTE 1 1G Pin, straight, .156" Lead Length (.018 dia) SEE NOTE 1 1H Pin, straight, .172" Lead Length (.018 dia) SEE NOTE 1 1J Pin, straight, .187" Lead Length (.018 dia) SEE NOTE 1 13 Pin, straight, .250" Lead Length (.018 dia) SEE NOTE 1 1K Pin, straight, .375" Lead Length (.018 dia) SEE NOTE 1 14 Pin, straight, .500" Lead Length (.018 dia) SEE NOTE 1 15 Pin, straight, 1.000" Lead Length (.018 dia) SEE NOTE 1 16 Pin, straight, crimped wire	TYPE CONTACTS/TERMINATIONS: 21 Socket, straight, 26 awg solder cup 2A Socket, straight, 24 awg solder cup 2D Socket, straight, .109" Lead Length (.018 dia) 2E Socket, straight, .125" Lead Length (.018 dia) 2F Socket, straight, .140" Lead Length (.018 dia) 22 Socket, straight, .150" Lead Length (.018 dia) 2G Socket, straight, .156" Lead Length (.018 dia) 2H Socket, straight, .172" Lead Length (.018 dia) 2J Socket, straight, .187" Lead Length (.018 dia) 23 Socket, straight, .250" Lead Length (.018 dia) 2K Socket, straight, .375" Lead Length (.018 dia) 2L Socket, straight, .500" Lead Length (.018 dia) 2M Socket, straight, 1.000" Lead Length (.018 dia) 24 Socket, straight, .500" Lead Length (.018 dia) SEE NOTE 1 25 Socket, straight, 1.000" Lead Length (.018 dia) SEE NOTE 1 26 Socket, straight, crimped wire		
PLATING OPTIONS: 1 50 μ" Au contacts (crimp wire) 3 50 μ" Au contacts; 10 μ" Au Terminations (solder cup, pigtail) 5 50 μ" Au contacts; Sn/Pb alloy terminations (pigtail) <input checked="" type="checkbox"/> 7 50 μ" Au contacts; SAC305 terminations (pigtail)	PLATING OPTIONS: 1 50 μ" Au contacts (crimp wire) 3 50 μ" Au contacts; 10 μ" Au Terminations (solder cup, pigtail) 5 50 μ" Au contacts; Sn/Pb alloy terminations (pigtail) <input checked="" type="checkbox"/> 7 50 μ" Au contacts; SAC305 terminations (pigtail)		
HARDWARE			
STYLE OF HARDWARE: 00 None 24 Two fixed jacknuts, rear panel mount, .040" panel thickness (64*) 26 Two fixed jacknuts, rear panel mount, .060" panel thickness (66*) 28 Two fixed jacknuts, rear panel mount, .070" panel thickness (68*) 29 Two fixed jacknuts, rear panel mount, .080" panel thickness (69*)	STYLE OF HARDWARE: 00 None 41 Two turning jackscrews, allen head, retaining ring (81*) 42 Two long turning jackscrews, allen head, retaining ring (82*) 43 Two turning jackscrews, slot head, retaining ring (83*) 44 Two long turning jackscrews, slot head, retaining ring (84*) 45 Two turning jackscrews, allen head, captivated** (85*)		
POLARIZATION / WIRING 00 None XX For wiring codes, see page MA-3 & MA-4	POLARIZATION / WIRING 00 None XX For wiring codes, see page MA-3 & MA-4		
OPTIONS			
EMI EMI o-ring (in lieu of fluorosilicone o-ring)	900 Interfacial sealing gasket		

* = Use number in parenthesis when ordering size 100.
 ** = Captive hardware is factory installed and non-removable.

NOTE 1 = The leads on these contacts are soft copper suitable for forming.

= Option not RoHS compliant



Cable to Board (Rear Panel Mount)

.050"

9 thru 100 Contacts

Rugged Board Mount

MK

Rugged Cable

MM, MN

MM-212-031-161-41WQ
(METAL)

MN-211-031-161-41WQ
(PLASTIC)

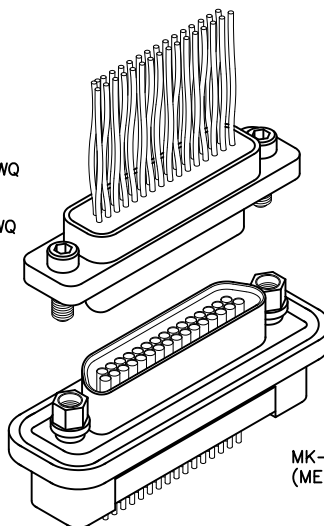

MK-2C2-031-235-2600
(METAL)

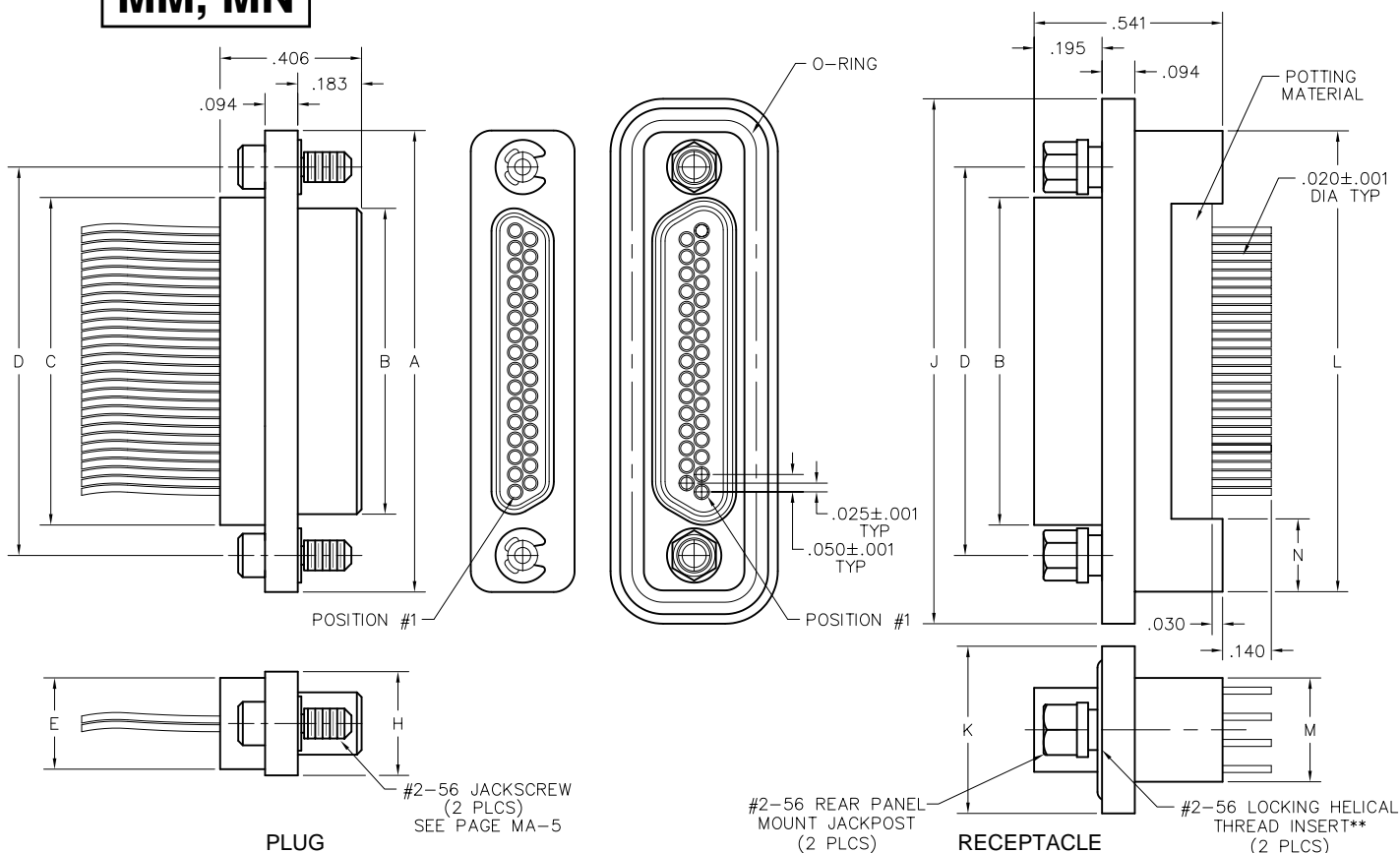

SIZE	CONTACT ROWS	A	B		C	D	E		H	HARDWARE	J	K	L	M	N
			PLUG MAX	RCPT MAX			POTTING WELL MAX								
9	2	.775	.334	.400	.390	.565	.270	.298	#2-56 UNC THD	.957	.480	.773	.298	.210	
15		.925	.484	.550	.540	.715				1.107		.923			
21		1.075	.634	.700	.690	.865				1.257		1.073			
25		1.175	.734	.800	.790	.965				1.357		1.173			
31		1.325	.884	.950	.940	1.115				1.507		1.323			
37	1.475	1.034	1.100	1.090	1.265	1.657	1.473								
51	3	1.425	.984	1.050	1.040	1.215	.310	.341	#2-56 UNC THD	1.657	.523	1.477	.440	.239	
69*		1.725	1.284	1.350	1.340	1.515				1.957		1.777			
100	4	2.160	1.384	1.508	1.432	1.800	.360	.384	#4-40 UNC THD	2.383	.600	2.219	.515	.301	

* = 69 POSITION CONNECTORS ARE AVAILABLE IN METAL ONLY.

** = SHELL ACCEPTS .200 MAX #2-56 SCREW LENGTH (.295 MAX #4-40 SCREW LENGTH).

PLUG: MM-212-031-161-41WQ
RECEPTACLE: MK-2C2-031-235-2600-EMI
PLUG: MN-211-031-161-41WQ
RECEPTACLE: MK-2C2-031-235-2600-EMI
 XX-XXX-XXX-XXX-XXXX-XXX

PLUG	RECEPTACLE
SERIES	
MM .050" Rugged Metal I/O Connector MN .050" Rugged Plastic I/O Connector (MM & MN mate with MK, ML, MM, MN receptacles)	MK .050" Rugged Metal PC Board Mount Connector (MK mates with MK, ML, MM, MN plugs)
BODY	
2 2-Row (Sizes 9 thru 37) 3 3-Row (Size 51 or 69) 4 4-Row (Size 100)	2 2-Row (Sizes 9 thru 37) 3 3-Row (Size 51 or 69) 4 4-Row (Size 100)
BODY STYLE: 1 Plug, straight, with ears	BODY STYLE: C Receptacle, straight, standard footprint, rear panel mount with fluorosilicone o-ring and interfacial seal
BODY MATERIAL: 1 Polyphenylene Sulfide (MN only) 2 Polyphenylene Sulfide with electroless nickel shell 3 Polyphenylene Sulfide with electrodeposited cadmium shell <input checked="" type="checkbox"/> 4 Polyphenylene Sulfide with hard anodized black shell	BODY MATERIAL: 2 Polyphenylene Sulfide with electroless nickel shell 3 Polyphenylene Sulfide with electrodeposited cadmium shell <input checked="" type="checkbox"/> 4 Polyphenylene Sulfide with hard anodized black shell
SIZE	
XXX 009, 015, 021, 025, 031, 037, 051, 069, 100	XXX 009, 015, 021, 025, 031, 037, 051, 069, 100
CONTACTS	
TYPE CONTACTS/TERMINATIONS: 11 Pin, straight, solder cup 14 Pin, straight, .500" pigtails (.018 dia) 15 Pin, straight, 1.000" pigtails (.018 dia) 16 Pin, straight, crimped wire	TYPE CONTACTS/TERMINATIONS: 22 Socket, straight, PCB leads, .109" 23 Socket, straight, PCB leads, .140" 24 Socket, straight, PCB leads, .172"
PLATING OPTIONS: 1 50 μ" Au contacts (crimp wire) 3 50 μ" Au contacts: 10 μ" Au terminations (solder cup, pigtail) 5 50 μ" Au contacts; Sn/Pb alloy terminations (pigtail) <input checked="" type="checkbox"/> 7 50 μ" Au contacts; SAC305 terminations (pigtail)	PLATING OPTIONS: 3 50 μ" Au contacts: 10 u" Au terminations 5 50 μ" Au contacts; Sn/Pb alloy terminations <input checked="" type="checkbox"/> 7 50 μ" Au contacts; SAC305 terminations
HARDWARE	
STYLE OF HARDWARE: 00 None 41 Two turning jackscrews, allen head, retaining ring (81*) 42 Two long turning jackscrews, allen head, retaining ring (82*) 43 Two turning jackscrews, slot head, retaining ring (83*) 44 Two long turning jackscrews, slot head, retaining ring (84*) 45 Two turning jackscrews, allen head, captivated** (85*)	STYLE OF HARDWARE: 00 None 24 Two fixed jacknuts, rear panel mount, .040" panel thickness (64*) 26 Two fixed jacknuts, rear panel mount, .060" panel thickness (66*) 28 Two fixed jacknuts, rear panel mount, .070" panel thickness (68*) 29 Two fixed jacknuts, rear panel mount, .080" panel thickness (69*)
POLARIZATION / WIRING: 00 None XX For wiring codes, see page MA-3 & MA-4	POLARIZATION / WIRING 00 None
OPTIONS	
	EMI EMI o-ring (in lieu of fluorosilicone o-ring)

* = Use number in parenthesis when ordering size 100.

** = Captive hardware is factory installed and non-removable.

= Option not RoHS compliant



Cable to Board (Rear Panel Mount)

.050"

9 thru 100 Contacts

Rugged Board Mount

MK

Rugged Cable

MM, MN

MM-222-031-261-41WQ
(METAL)

MN-221-031-261-41WQ
(PLASTIC)

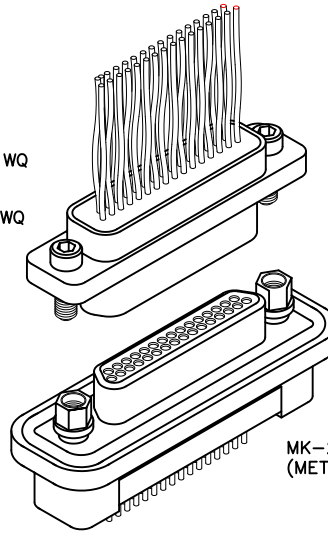

MK-2A2-031-135-2600-EMI
(METAL)

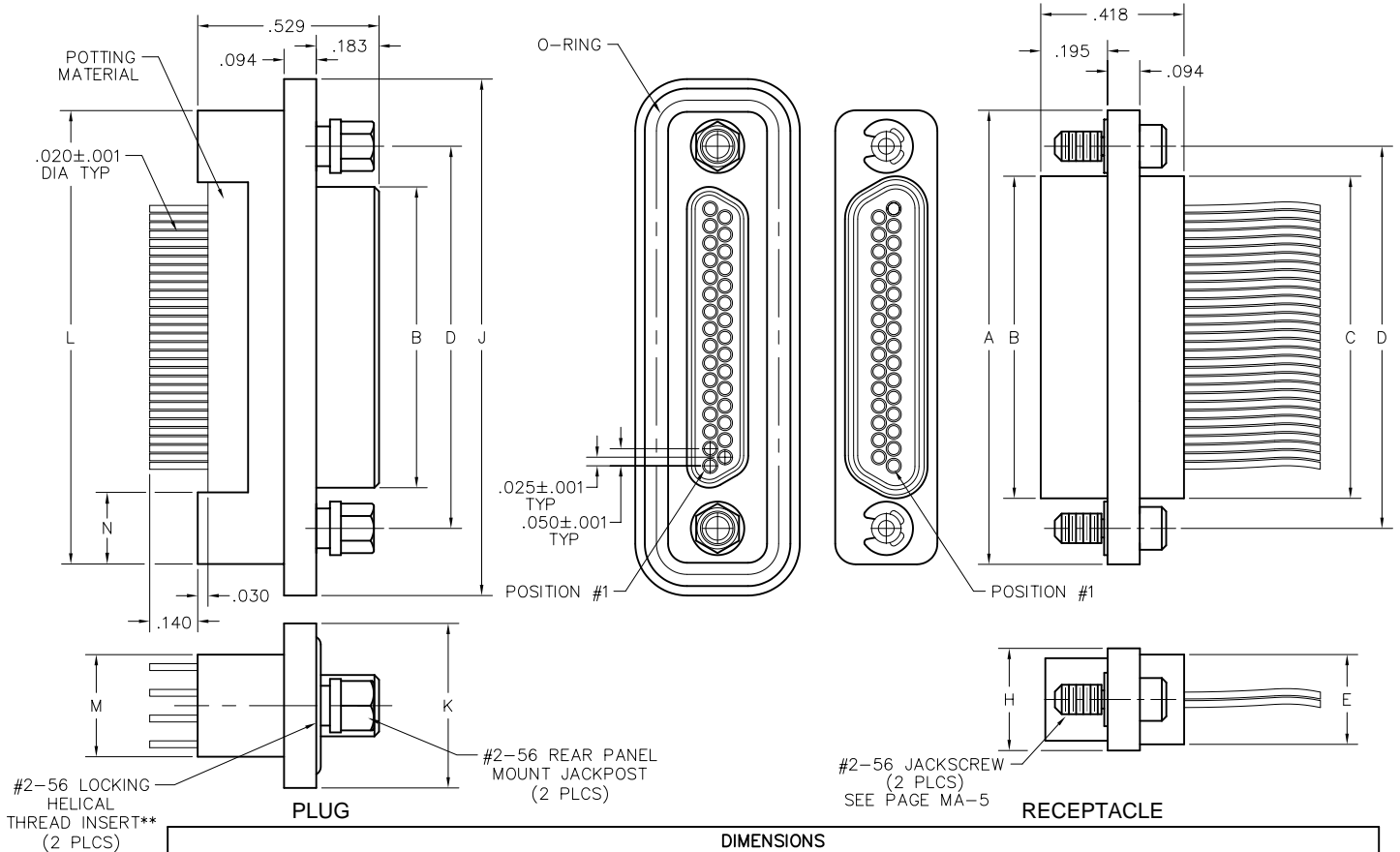

SIZE	CONTACT ROWS	DIMENSIONS												
		B		C	D	E		H	HARDWARE	J	K	L	M	N
		PLUG MAX	RCPT MAX			POTTING WELL MAX								
9	2	.775	.334	.400	.390	.565	.270	.298	#2-56 UNC THD	.957	.480	.773	.298	.210
15		.925	.484	.550	.540	.715				1.107		.923		
21		1.075	.634	.700	.690	.865				1.257		1.073		
25		1.175	.734	.800	.790	.965				1.357		1.173		
31		1.325	.884	.950	.940	1.115				1.507		1.323		
37	1.475	1.034	1.100	1.090	1.265	1.657	1.473							
51	3	1.425	.984	1.050	1.040	1.215	.310	.341	.523	1.657	1.477	.440	.239	
69*		1.725	1.284	1.350	1.340	1.515				1.957	1.777			
100		4	2.160	1.384	1.508	1.432				1.800	.360			.384

* = 69 POSITION CONNECTORS ARE AVAILABLE IN METAL ONLY.

** = SHELL ACCEPTS .200 MAX #2-56 SCREW LENGTH (.295 MAX #4-40 SCREW LENGTH).

PLUG: MK-2A2-031-135-2600-EMI
RECEPTACLE: MM-222-031-261-41WQ
PLUG: MK-2A2-031-135-2600-EMI
RECEPTACLE: MN-221-031-261-41WQ
 XX-XXX-XXX-XXX-XXXX-XXX

PLUG		RECEPTACLE	
SERIES			
MK .050" Rugged Metal PC Board Mount Connector (MK mates with MK, ML, MM, MN receptacles)		MM .050" Rugged Metal I/O Connector MN .050" Rugged Plastic I/O Connector (MM & MN mate with MK, ML, MM, MN plugs)	
BODY			
2 2-Row (Sizes 9 thru 37)	3 3-Row (Size 51 or 69)	2 2-Row (Sizes 9 thru 37)	3 3-Row (Size 51 or 69)
4 4-Row (Size 100)		4 4-Row (Size 100)	
BODY STYLE: A Plug, straight, standard footprint, rear panel mount with fluorosilicone o-ring		BODY STYLE: 2 Receptacle, straight, with ears	
BODY MATERIAL: 2 Polyphenylene Sulfide with electroless nickel shell 3 Polyphenylene Sulfide with electrodeposited cadmium shell <input checked="" type="checkbox"/> 4 Polyphenylene Sulfide with hard anodized black shell		BODY MATERIAL: 1 Polyphenylene Sulfide (MN only) 2 Polyphenylene Sulfide with electroless nickel shell 3 Polyphenylene Sulfide with electrodeposited cadmium shell <input checked="" type="checkbox"/> 4 Polyphenylene Sulfide with hard anodized black shell	
SIZE			
XXX 009, 015, 021, 025, 031, 037, 051, 069, 100		XXX 009, 015, 021, 025, 031, 037, 051, 069, 100	
CONTACTS			
TYPE CONTACTS/TERMINATIONS: 12 Pin, straight, PCB leads, .109" 13 Pin, straight, PCB leads, .140" 14 Pin, straight, PCB leads, .172"		TYPE CONTACTS/TERMINATIONS: 21 Socket, straight, solder cup 24 Socket, straight, .500" pigtails (.018 dia) 25 Socket, straight, 1.000" pigtails (.018 dia) 26 Socket, straight, crimped wire	
PLATING OPTIONS: 3 50 μ" Au contacts; 10 μ" Au terminations 5 50 μ" Au contacts; Sn/Pb alloy terminations <input checked="" type="checkbox"/> 7 50 μ" Au contacts; SAC305 terminations		PLATING OPTIONS: 1 50 μ" Au contacts (crimp wire) 3 50 μ" Au contacts; 10 μ" Au terminations (solder cup, pigtail) 5 50 μ" Au contacts; Sn/Pb alloy terminations (pigtail) <input checked="" type="checkbox"/> 7 50 μ" Au contacts; SAC305 terminations (pigtail)	
HARDWARE			
STYLE OF HARDWARE: 00 None 24 Two fixed jacknuts, rear panel mount, .040" panel thickness (64*) 26 Two fixed jacknuts, rear panel mount, .060" panel thickness (66*) 28 Two fixed jacknuts, rear panel mount, .070" panel thickness (68*) 29 Two fixed jacknuts, rear panel mount, .080" panel thickness (69*)		STYLE OF HARDWARE: 00 None 41 Two turning jackscrews, allen head, retaining ring (81*) 42 Two long turning jackscrews, allen head, retaining ring (82*) 43 Two turning jackscrews, slot head, retaining ring (83*) 44 Two long turning jackscrews, slot head, retaining ring (84*) 45 Two turning jackscrews, allen head, captivated** (85*)	
POLARIZATION / WIRING: 00 None		POLARIZATION / WIRING 00 None XX For wiring codes, see page MA-3 & MA-4	
OPTIONS			
EMI EMI o-ring (in lieu of fluorosilicone o-ring)		900 Interfacial sealing gasket	

* = Use number in parenthesis when ordering size 100.
 ** = Captive hardware is factory installed and non-removable.
 = Option not RoHS compliant



Recommended PC Board Layout

Straight, Standard Footprint

CONNECTOR MATING FACE (PLUG)

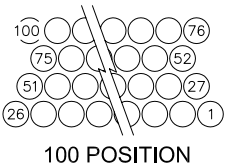
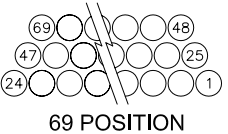
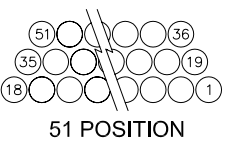
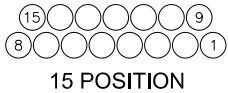
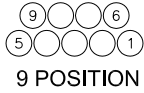

PLUG PC BOARD LAYOUT COMPONENT SIDE

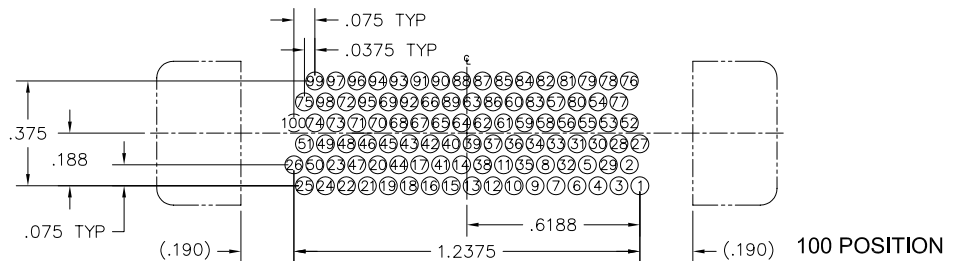
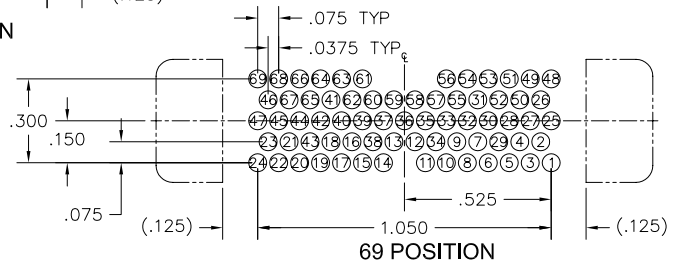
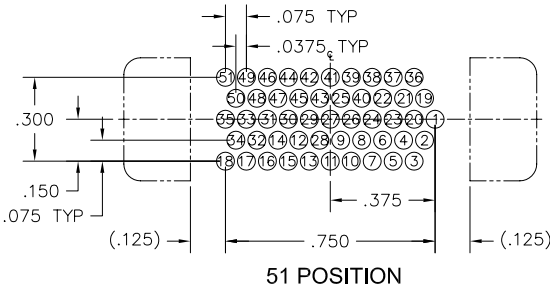
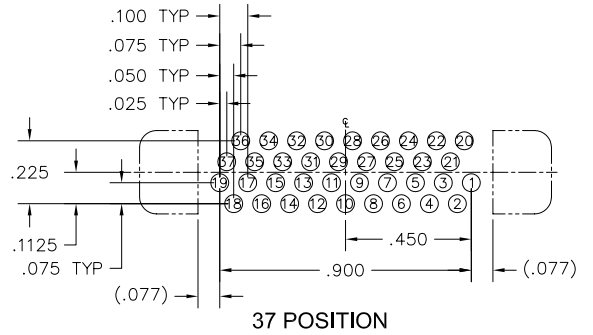
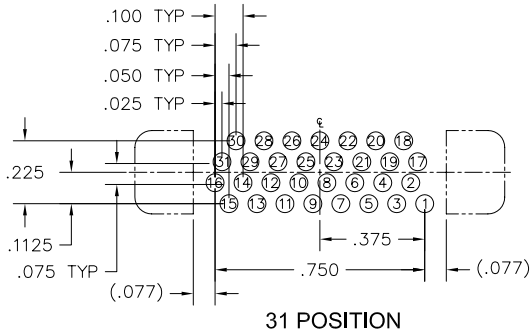
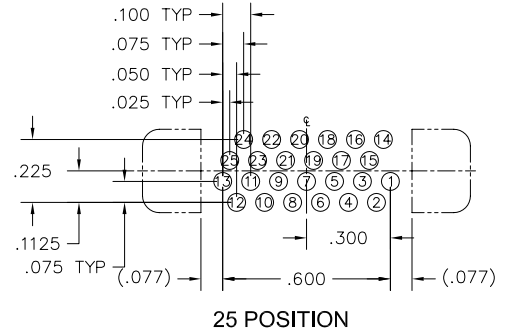
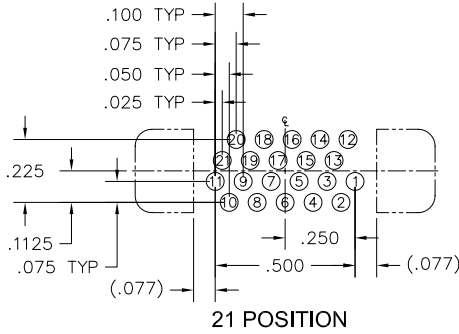
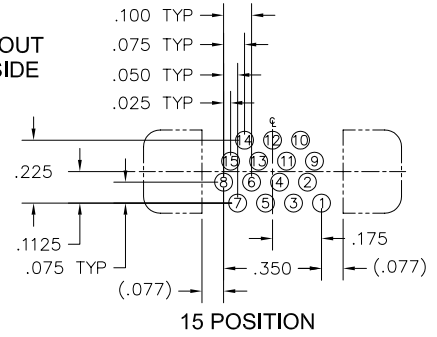
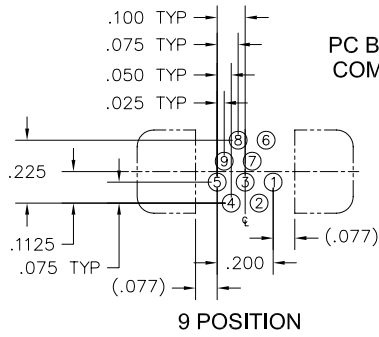



Recommended PC Board Layout

Straight, Standard Footprint

RECEPTACLE PC BOARD LAYOUT COMPONENT SIDE

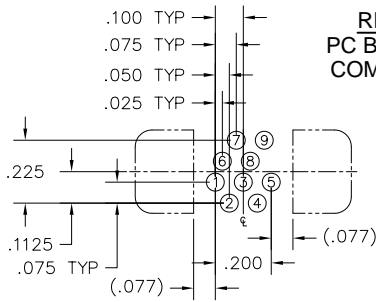

9 POSITION

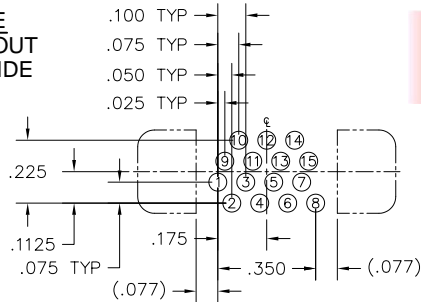

15 POSITION

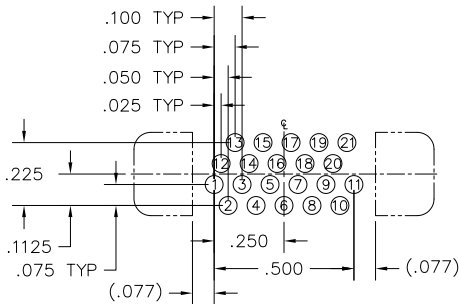

21 POSITION

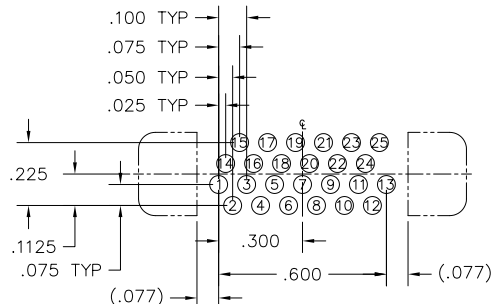

25 POSITION

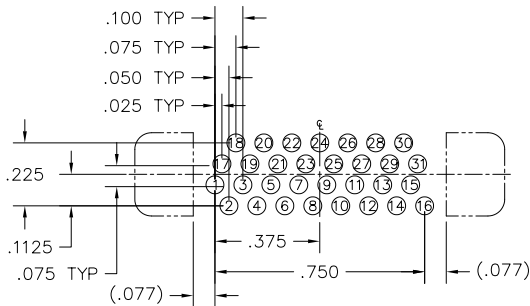

31 POSITION

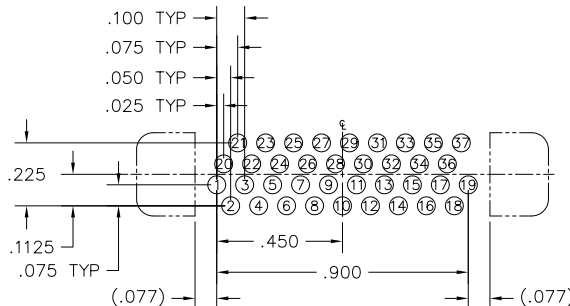

37 POSITION

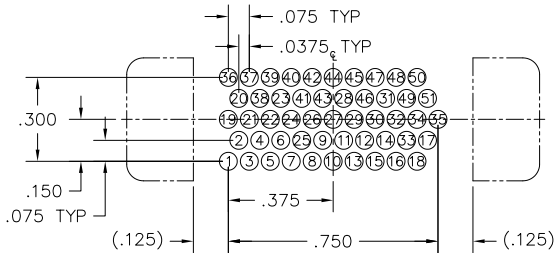

51 POSITION

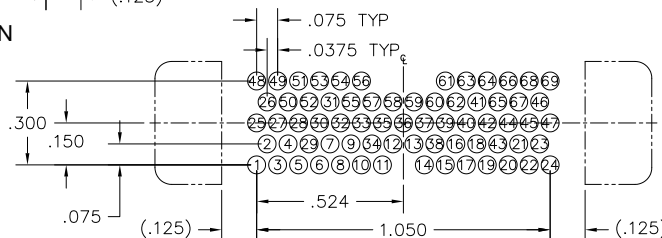

69 POSITION

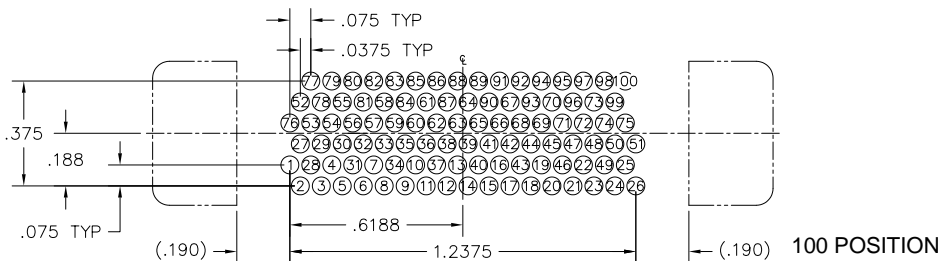

100 POSITION

CONNECTOR MATING FACE (RECEPTACLE)



9 POSITION



15 POSITION



21 POSITION



25 POSITION



31 POSITION



37 POSITION



51 POSITION



69 POSITION



100 POSITION



Rear Panel Mount, Right Angle Boardmount

.050"

9 thru 100 Contacts

MK

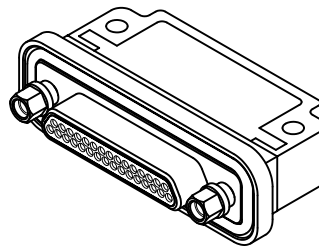

MK-2D2-031-335-260S
(PLUG)

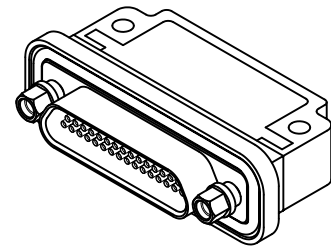

MK-2E2-031-445-260S
(RECEPTACLE)

MATING MATRIX	
CONNECTOR	MATES WITH
MK-2D...	MK, ML, MM, MN receptacles
MK-2E...	MK, ML, MM, MN plugs

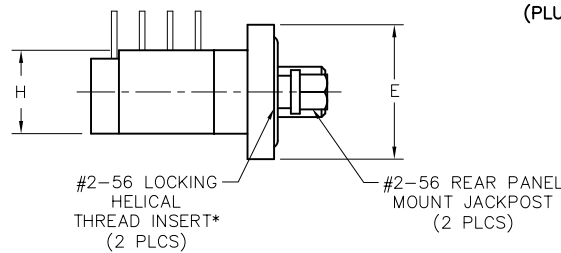
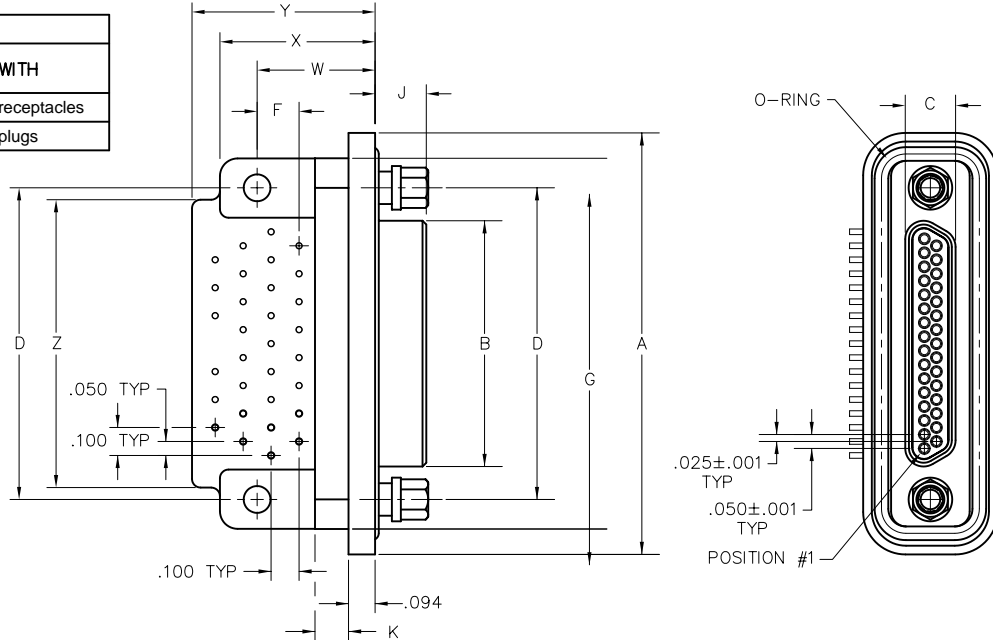

(PLUG SHOWN)

DIMENSIONS

SIZE	CONTACT ROWS	A	B		C		D	E	F	G	H	J		K	W	X MAX	Y MAX	Z	HARDWARE	MOUNTING HOLE	
			PLUG MAX	RCPT MAX	PLUG MAX	RCPT MAX						PLUG	RCPT								
9	2	.957	.334	.400	.185	.251	.565	.480	.150	.775	.298	.183	.195	.120	.421	.560	.560	1.075	#2-56 UNC THD	.096 DIA OR #2-56 UNC THREADED INSERT	
15		1.107	.484	.550			.715														.925
21		1.257	.634	.700			.865														1.075
25		1.357	.734	.800			.965														1.175
31		1.507	.884	.950			1.115														1.325
37		1.657	1.034	1.100			1.265														1.475
51	3	1.657	.984	1.050	.228	.294	1.215	.523	.150	1.425	.341	.183	.195	.120	.421	.550	.770	1.220	#4-40 UNC THD	.125 DIA OR #4-40 UNC THREADED INSERT	
69		1.957	1.284	1.350			1.515			1.725						.870	1.450				
100		4	2.383	1.384			1.508			.271						.394	1.800	.600			.200

** = SHELL ACCEPTS .190 MAX #2-56 SCREW LENGTH (.220 MAX #4-40 SCREW LENGTH).

Call (972) 931-3200 Fax (972) 931-9305 www.AirBorn.com



PLUG: MK 2D2-031-335-260S
RECEPTACLE: MK 2E2-031-445-260S
 XX-XXX-XXX-XXX-XXXX-XXX
 | BODY | CONTACTS | OPTIONS
 SERIES SIZE HARDWARE

PLUG

SERIES

MK .050" Rugged Metal PC Board Mount Connector

BODY

- 2 2-Row (Sizes 9 thru 37)
- 3 3-Row (Size 51 & 69)
- 4 4-Row (Size 100)

BODY STYLE:
 D Plug, right angle, rear panel mount with fluorosilicone o-ring

BODY MATERIAL:
 2 Electroless nickel shell w/ PPS insulator
 3 Electrodeposited cadmium shell w/ PPS insulator
 4 Hard anodized black shell w/ PPS insulator

SIZE

XXX 009, 015, 021, 025, 031, 037, 051, 069, 100

CONTACTS

TYPE CONTACTS/TERMINATIONS:
 32 Pin, right angle, PCB leads, .109"
 33 Pin, right angle, PCB leads, .140"
 34 Pin, right angle, PCB leads, .172"

PLATING OPTIONS:
 3 50 μ" Au contacts
 5 50 μ" Au contacts; Sn/Pb alloy terminations
 7 50, u" Au contacts; SAC305 terminations

HARDWARE

STYLE OF HARDWARE:
 00 None
 24 Two fixed jacknuts, rear panel mount, .040" panel thickness (64*)
 26 Two fixed jacknuts, rear panel mount, .060" panel thickness (66*)
 28 Two fixed jacknuts, rear panel mount, .070" panel thickness (68*)
 29 Two fixed jacknuts, rear panel mount, .080" panel thickness (69*)

POLARIZATION:
 0S Standard body polarization

OPTIONS

EMI EMI gasket (in lieu of fluorosilicone o-ring)
 0B7 Threaded inserts in mounting holes
 0FW Threaded inserts in mounting holes and EMI gasket (in lieu of fluorosilicone o-ring)

NOTES

See page MA-10 for rear panel mounting dimensions.
 See page MA-7 for rear panel hardware dimensions.

* = Use numbers in parenthesis when ordering size 100.
 = Option not RoHS compliant

RECEPTACLE

SERIES

MK .050" Rugged Metal PC Board Mount Connector

BODY

- 2 2-Row (Sizes 9 thru 37)
- 3 3-Row (Size 51 & 69)
- 4 4-Row (Size 100)

BODY STYLE:
 E Receptacle, right angle, rear panel mount with fluorosilicone o-ring and interfacial seal

BODY MATERIAL:
 2 Electroless nickel shell w/ PPS insulator
 3 Electrodeposited cadmium shell w/ PPS insulator
 4 Hard anodized black shell w/ PPS insulator

SIZE

XXX 009, 015, 021, 025, 031, 037, 051, 069, 100

CONTACTS

TYPE CONTACTS/TERMINATIONS:
 43 Socket, right angle, PCB leads, .109"
 44 Socket, right angle, PCB leads, .140"
 45 Socket, right angle, PCB leads, .172"

PLATING OPTIONS:
 3 50 μ" Au contacts
 5 50 μ" Au contacts; Sn/Pb alloy terminations
 7 50, u" Au contacts; SAC305 terminations

HARDWARE

STYLE OF HARDWARE:
 00 None
 24 Two fixed jacknuts, rear panel mount, .040" panel thickness (64*)
 26 Two fixed jacknuts, rear panel mount, .060" panel thickness (66*)
 28 Two fixed jacknuts, rear panel mount, .070" panel thickness (68*)
 29 Two fixed jacknuts, rear panel mount, .080" panel thickness (69*)

POLARIZATION:
 0S Standard body polarization

OPTIONS

EMI EMI gasket (in lieu of fluorosilicone o-ring)
 0B7 Threaded inserts in mounting holes
 0FW Threaded inserts in mounting holes and EMI gasket (in lieu of fluorosilicone o-ring)

NOTES

See page MA-10 for rear panel mounting dimensions.
 See page MA-7 for rear panel hardware dimensions.

Ask About AirBorn's Accelerated Delivery Service



Recommended PC Board Layout

Right Angle, Narrow Footprint
Rear Panel Mount
Standard Polarization



CONNECTOR MATING FACE

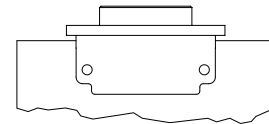

PC BOARD LAYOUT COMPONENT SIDE

PLUG
PC BOARD LAYOUT
COMPONENT SIDE

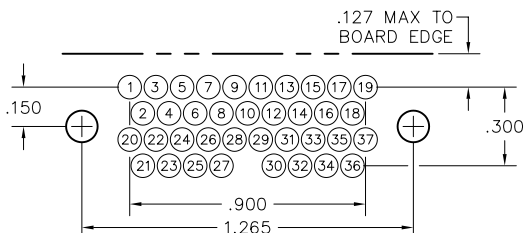
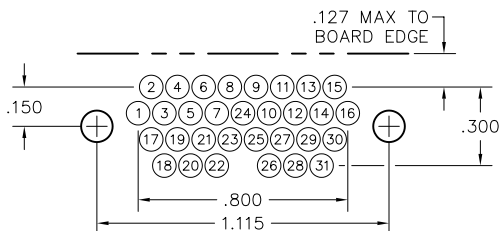
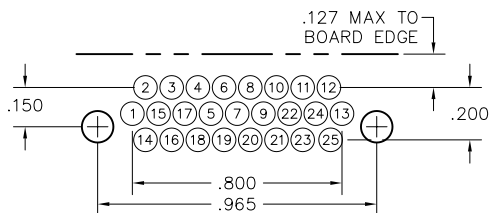
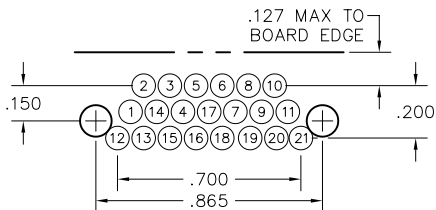
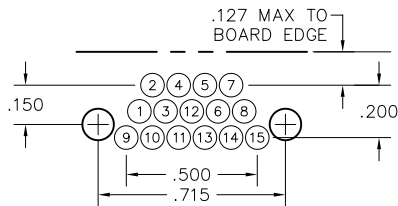
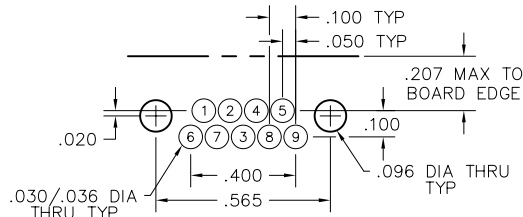

CONNECTOR
MATING FACE*
(RECEPTACLE)

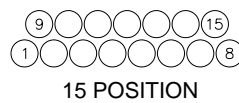
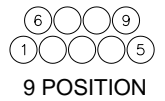

RECEPTACLE
PC BOARD LAYOUT
COMPONENT SIDE

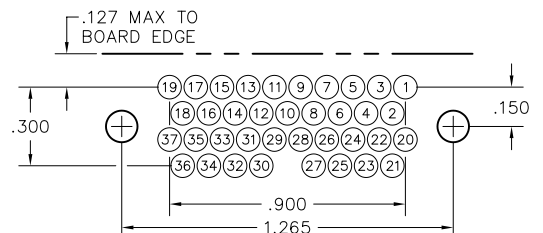
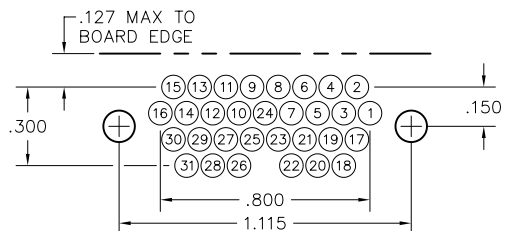
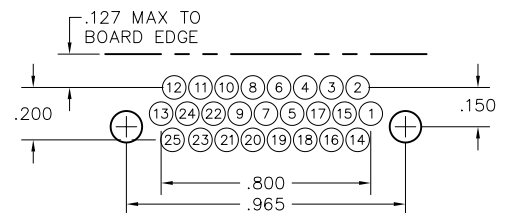
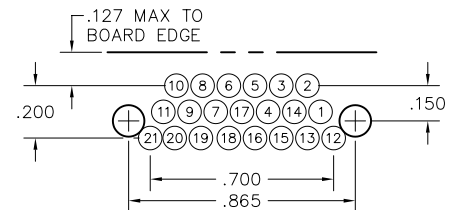
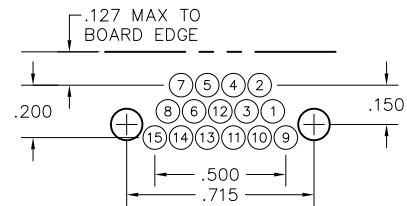
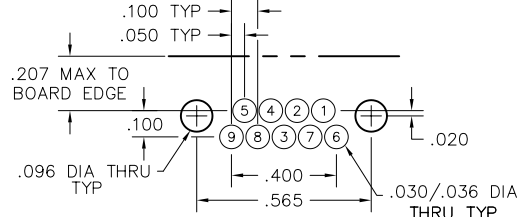

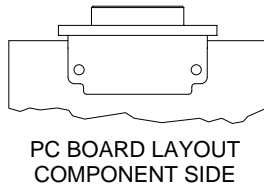
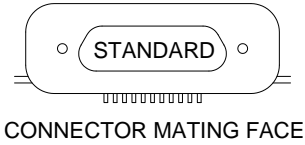

Recommended PC Board Layout

Right Angle, Narrow Footprint
Rear Panel Mount
Standard Polarization

PLUG
PC BOARD LAYOUT
COMPONENT SIDE

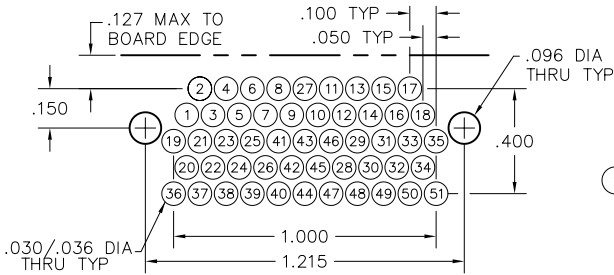

CONNECTOR
MATING FACE*
(RECEPTACLE)

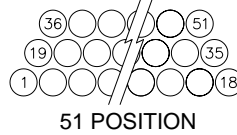

RECEPTACLE
PC BOARD LAYOUT
COMPONENT SIDE

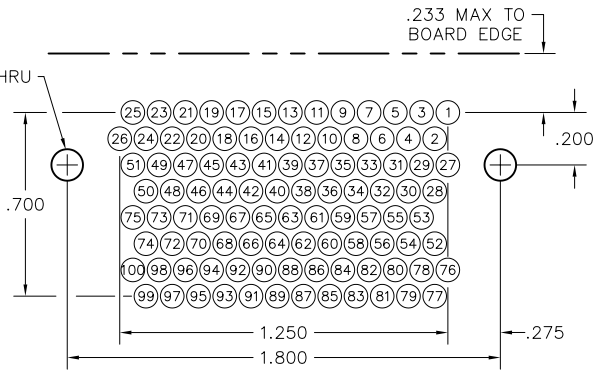
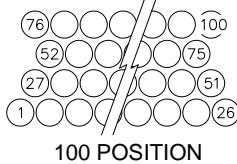
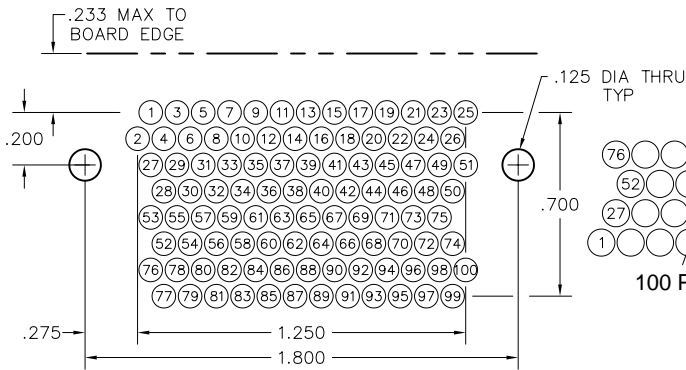
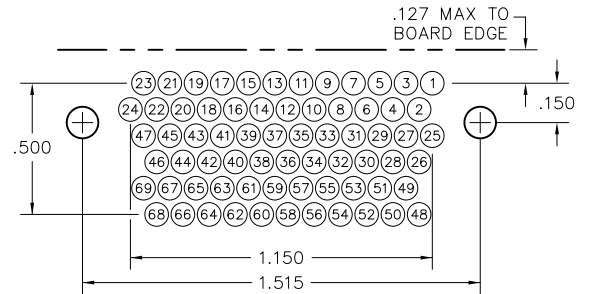
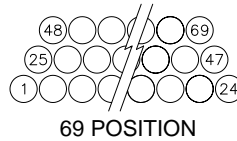
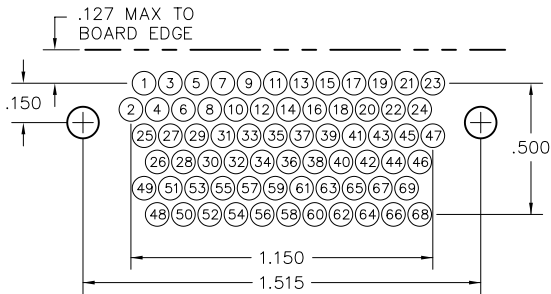
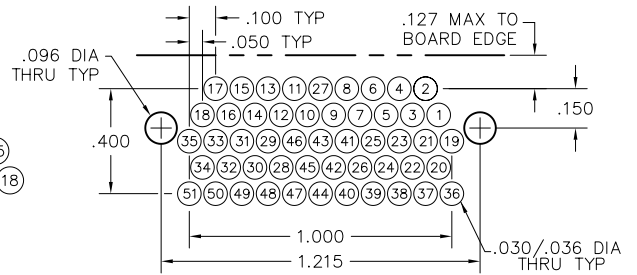

* For pin (plug) connectors, the contact numbers are reversed left to right.



Specifications - Sealed Connectors Materials and Finishes *

Contacts:	Pins: BeCu alloy strip per ASTM B194 Sockets: Brass per ASTM B16 / B16M or ASTM B453 Uninsulated/solid wire tails: Brass per ASTM B16 / B16M or ASTM B453
Contact Finish:	Gold plate per ASTM B488
Shells:	Aluminum Alloy 6061-T6 per SAE AMS-QQ-A-250/11 or 6061-T6511 per SAE AMS-QQ-A-200/8
Aluminum Shell Finishes:	Electroless Nickel per SAE AMS2404, Class 3, 500 μ " min Electrodeposited Cadmium per SAE AMS-QQ-P-416, Type II, Class 3 Black Anodized per MIL-A-8625, Type III, Class 2
Molded Insulators:	Glass filled polyphenylene sulfide per MIL-M-24519
Embedment:	Frey Engineering Co. insulating compound CF3003-80 and L-II-49 or equivalent
Jackposts:	Corrosion resistant steel per ASTM A320 or ASTM A484 / A484M and ASTM A582 / A582M Passivated per SAE AMS2700
Gaskets:	Interfacial: Fluorosilicone per SAE AMS-R-25988 Flange: Butyl per SAE AMS3238** Internal: EPDM per ASTM D2000**
Tolerances:	Unless otherwise specified: Fractions = $\pm 1/64$ " Decimals = $\pm .010$ " Angles = $\pm 5^\circ$ Wire lengths: insulated/stranded = $+1.0"/-0.0$ " uninsulated/solid = $+0.2"/-0.0$ "

Note: AirBorn can manufacture special configurations for your exact specifications.

* Reference the above listed specifications or an equivalent industry standard when applicable.

** Chemical compatibility of gasket materials must be considered for each application.

Contact AirBorn for specific application questions.

Performance

Interface:	Per M83513
Contact Rating:	3-amperes maximum
Solderability:	Terminals (except crimp) tested in accordance with MIL-STD-202, Method 208
Wire Size:	Stranded #24, #26, #28 AWG or solid #25 AWG standard (consult factory for other sizes and types)
Test Voltage:	600 V, RMS, 60 Hz
Operating Temperature:	-55° C to +100° C
Insulation Resistance:	5,000 megohms minimum @ 500 VDC
Durability:	500 connector mating cycles
Vibration:	Tested in accordance with EIA-364-28, Condition IV, according to MIL-83513
Shock:	Tested in accordance with EIA-364-27, Condition E, according to MIL-83513
Salt Spray:	Mated connectors tested in accordance with EIA-364-26, Test Condition B, according to M83513
Humidity:	Mated connectors tested in accordance with EIA-364-31, Method IV (except steps 7a and 7b)
Thermal Shock:	Tested to the temperature extremes of EIA-364-32, Method A, Test Condition I (except step 3, temperature shall be 100° C)
Contact Resistance:	0.065 volt maximum drop @ 2.5 amps (.026 ohms), according to M83513
Contact Engaging Force:	6.0 ounce maximum, with .0221 diameter test sleeve
Contact Separating Force:	0.5 ounce minimum, with .0230 diameter test sleeve
Crimp Strength:	5 pound minimum tensile strength
Sealing:	15 PSI per EIA-364-02 at room temperature, 5 minutes with no visible air leaks, positive pressure from wire (back side) of connector. (Body Styles E & H) 30 PSI per EIA-364-02 at room temperature, 5 minutes with no visible air leaks, positive pressure from wire (back side) of connector. (Body Styles K & L)

Ask About AirBorn's Accelerated Delivery Service



Rugged Metal I/O (Sealed Connector)

.050"

9 thru 100 Contacts

MM

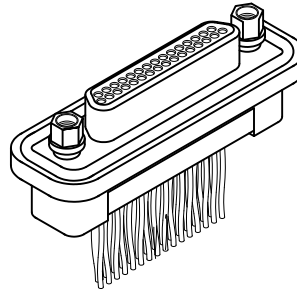

MM-2E2-031-161-26WA
(PLUG)

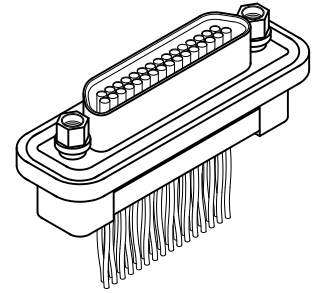

MM-2H2-031-261-26WA
(RECEPTACLE)

MATING MATRIX	
CONNECTOR	MATES WITH
MM-2E...	MK, ML, MM, MN receptacles
MM-2H...	MK, ML, MM, MN plugs
MM-2K...	MK, ML, MM, MN receptacles
MM-2L...	MK, ML, MM, MN plugs

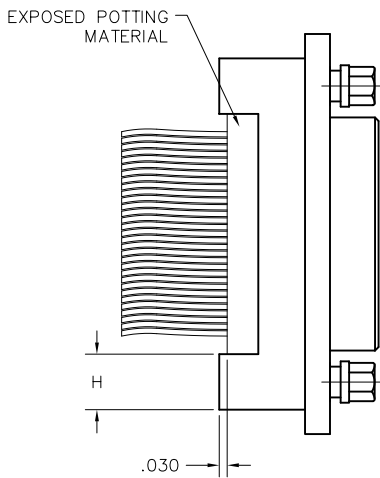

STRANDED WIRE TERMINATION
(PLUG SHOWN)

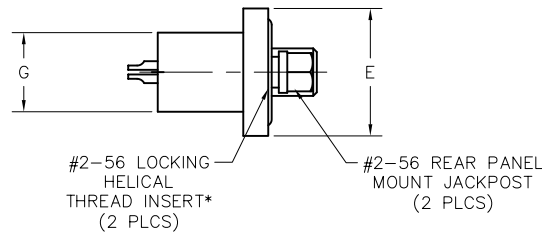
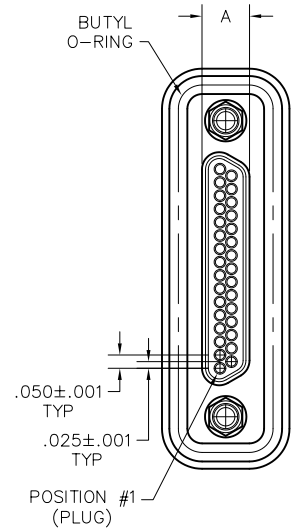
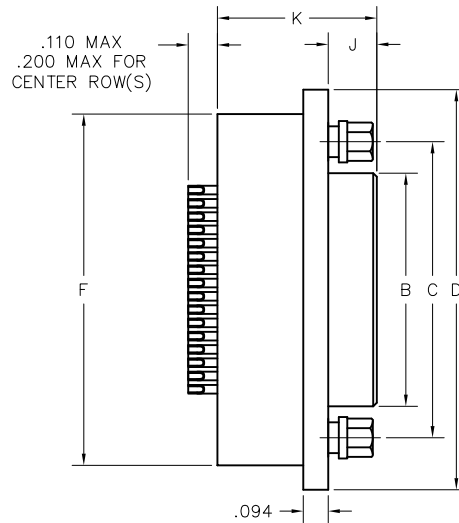

SOLDER CUP OR PIGTAIL TERMINATION
(PLUG WITH SOLDER CUP TERMINATION SHOWN)

DIMENSIONS																
SIZE	CONTACT ROWS	A		B		C	HARDWARE	D	E	F	G	H	J		K	
		PLUG MAX	RCPT MAX	PLUG MAX	RCPT MAX								PLUG	RCPT	PLUG	RCPT
9	2	.185	.251	.334	.400	.565	#2-56 UNC THD	.957	.480	.773	.298	.210	.183	.195	.598	.610
15				.484	.550	.715		1.107		.923						
21				.634	.700	.865		1.257		1.073						
25				.734	.800	.965		1.357		1.173						
31				.884	.950	1.115		1.507		1.323						
37				1.034	1.100	1.265		1.657		1.473						
51	3	.228	.294	.984	1.050	1.215	#2-56 UNC THD	1.657	.523	1.477	.440	.239	.183	.195	.598	.610
69				1.284	1.350	1.515		1.957		1.777						
100	4	.271	.394	1.384	1.508	1.800	#4-40 UNC THD	2.383	.600	2.219	.515	.301	.183	.195	.598	.610

** = SHELL ACCEPTS .200 MAX #2-56 SCREW LENGTH (.295 MAX #4-40 SCREW LENGTH).

Call (972) 931-3200 Fax (972) 931-9305 www.AirBorn.com

PLUG: MM-2E2-031-161-26WA

RECEPTACLE: MM-2H2-031-261-26WA

XX-XXX-XXX-XXX-XXXX

SERIES SIZE HARDWARE & WIRING
BODY CONTACTS



PLUG

RECEPTACLE

SERIES

MM .050" Rugged Metal I/O Connector

BODY

- 2 2-Row (Sizes 9 thru 37)
- 3 3-Row (Sizes 51 thru 69)
- 4 4-Row (Size 100)

BODY STYLE:

- E Plug, straight, rear panel mount.
Sealed to 15 PSI pressure differential.
- K Plug, straight, rear panel mount.
Sealed to 30 PSI pressure differential.

All seal ratings are in the unmated condition

BODY MATERIAL:

- 2 Polyphenylene Sulfide with electroless nickel shell
- 3 Polyphenylene Sulfide with electrodeposited cadmium shell
- 4 Polyphenylene Sulfide with hard anodized black shell

SIZE

XXX 009, 015, 021, 025, 031, 037, 051, 069, 100

CONTACTS

TYPE CONTACTS/TERMINATIONS:

- 11 Pin, straight, solder cup
- 14 Pin, straight, .500" pigtails (.018 dia)
- 16 Pin, straight, stranded wire

PLATING OPTIONS:

- 1 50 μ" Au contacts (stranded wire)
- 3 50 μ" Au contacts; Au terminations (solder cup, pigtail)
- 5 50 u" Au contacts; Sn/Pb alloy terminations (pigtail)
- 7 50 u" Au contacts; SAC305 terminations (pigtail)

HARDWARE & WIRING

STYLE OF HARDWARE:

- 00 None
- 24 Two fixed jacknuts, rear panel mount, .040" panel thickness (64*)
- 26 Two fixed jacknuts, rear panel mount, .060" panel thickness (66*)
- 28 Two fixed jacknuts, rear panel mount, .070" panel thickness (68*)
- 29 Two fixed jacknuts, rear panel mount, .080" panel thickness (69*)

WIRING:

- 00 None (solder cup and pigtail only)
- XX For wiring codes, see page MA-3 & MA-4

NOTES

See page MA-10 for rear panel mounting dimensions.
See page MA-7 for hardware dimensions.
See Product Technical Bulletin #43 for soldering to solder cups.

SERIES

MM .050" Rugged Metal I/O Connector

BODY

- 2 2-Row (Sizes 9 thru 37)
- 3 3-Row (Sizes 51 thru 69)
- 4 4-Row (Size 100)

BODY STYLE:

- H Receptacle, straight, rear panel mount, with fluorosilicone interfacial seal.
Sealed to 15 PSI pressure differential.
- L Receptacle, straight, rear panel mount, with fluorosilicone interfacial seal.
Sealed to 30 PSI pressure differential.

All seal ratings are in the unmated condition

BODY MATERIAL:

- 2 Polyphenylene Sulfide with electroless nickel shell
- 3 Polyphenylene Sulfide with electrodeposited cadmium shell
- 4 Polyphenylene Sulfide with hard anodized black shell

SIZE

XXX 009, 015, 021, 025, 031, 037, 051, 069, 100

CONTACTS

TYPE CONTACTS/TERMINATIONS:

- 21 Socket, straight, solder cup
- 24 Socket, straight, .500" pigtails (.018 dia)
- 26 Socket, straight, crimped wire

PLATING OPTIONS:

- 1 50 μ" Au contacts (stranded wire)
- 3 50 μ" Au contacts; Au terminations (solder cup, pigtail)
- 5 50 u" Au contacts; Sn/Pb alloy terminations (pigtail)
- 7 50 u" Au contacts; SAC305 terminations (pigtail)

HARDWARE & WIRING

STYLE OF HARDWARE:

- 00 None
- 24 Two fixed jacknuts, rear panel mount, .040" panel thickness (64*)
- 26 Two fixed jacknuts, rear panel mount, .060" panel thickness (66*)
- 28 Two fixed jacknuts, rear panel mount, .070" panel thickness (68*)
- 29 Two fixed jacknuts, rear panel mount, .080" panel thickness (69*)

WIRING:

- 00 None (solder cup and pigtail only)
- XX For wiring codes, see page MA-3 & MA-4

NOTES

See page MA-10 for rear panel mounting dimensions.
See page MA-7 for hardware dimensions.
See Product Technical Bulletin #43 for soldering to solder cups.

* = Use numbers or letters in parenthesis when ordering size 100.

= Option not RoHS compliant

Ask About AirBorn's Accelerated Delivery Service



Cable to Cable (1 Row)

.050"

4 thru 25 Contacts

MM

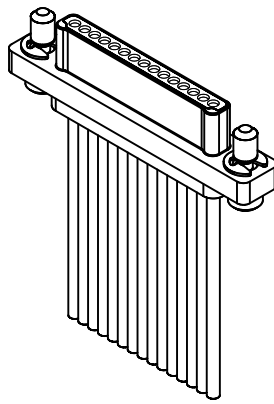

MM-112-015-161-41WQ
(PLUG)

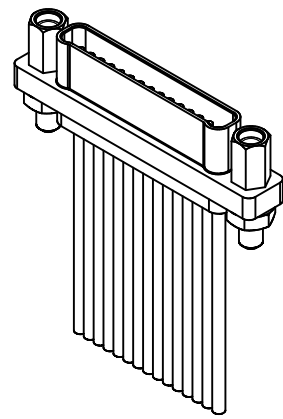

MM-122-015-261-22WQ
(RECEPTACLE)

MATING MATRIX	
CONNECTOR	MATES WITH
MM-11...	MM-12, MK-16, MK-18 receptacles
MM-12...	MM-11, MK-15, MK-17 plugs

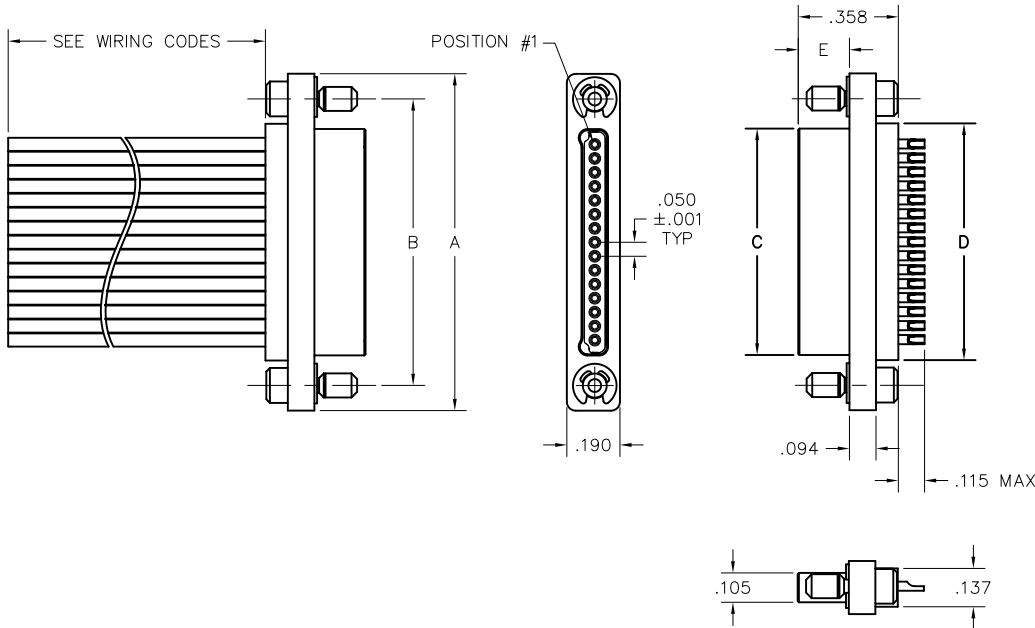

PLUG SHOWN

SIZE	DIMENSIONS						HARDWARE	
	A	B	C		D	E		
			PLUG MAX	RCPT MAX		PLUG MAX		RCPT MAX
4	.655	.475	.260	.263	.297	.186	.198	#2-56 UNC THD (ϕ .092 THRU)
5	.705	.525	.310	.313	.347			
6	.755	.575	.360	.363	.397			
9	.905	.725	.510	.513	.547			
12	1.055	.875	.660	.663	.697			
15	1.205	1.025	.810	.813	.847			
21	1.505	1.325	1.110	1.113	1.147			
25	1.705	1.525	1.310	1.313	1.347			

Call (972) 931-3200 Fax (972) 931-9305 www.AirBorn.com

PLUG: MM-112-006-113-2200
RECEPTACLE: MM-122-006-2A3-4100
XX-XXX-XXX-XXX-XXXX-XXX
 | | | |
 BODY CONTACTS OPTIONS
 SERIES SIZE HARDWARE

PLUG

SERIES

MM .050" Rugged Metal I/O Connector
(MM mates to MK & MM)

BODY

- 1 1-Row (Sizes 4 thru 25)
 BODY STYLE:
1 Plug, straight
 BODY MATERIAL:
- 2 Electroless nickel shell w/ PPS insert
- 3 Electrodeposited cadmium shell w/ PPS insert
- 5 Stainless Steel shell w/ PPS insert

SIZE

XXX 004, 005, 006, 009, 012, 015, 021, 025

CONTACTS

- TYPE CONTACTS/TERMINATIONS:
- 11 Pin, straight, 26 awg solder cup
 - 1A Pin, straight, 24 awg solder cup
 - 12 Pin, straight, 0.150" pigtails (.018 dia)
 - 13 Pin, straight, 0.250" pigtails (.018 dia)
 - 14 Pin, straight, 0.500" pigtails (.018 dia)
 - 16 Pin, straight, crimped wire
- PLATING OPTIONS:
- 1 50 u" Au contacts (Crimped Wire)
 - 3 50 u" Au contacts; Au terminations (solder cup, pigtail)
 - 5 50 u" Au contacts; Sn/Pb alloy terminations (pigtail)
 - 7 50 u" Au contacts; SAC305 terminations (pigtail)

HARDWARE

- STYLE OF HARDWARE:
- 00 None
 - 22 Two fixed jacknut assemblies
 - 41 Two turning jackscrews, allen head, retaining ring
 - 45 Two turning jackscrews, allen head, captivated**

WIRING

XX For wiring codes, see page MA-3 & MA-4

OPTIONS

RECEPTACLE

SERIES

MM .050" Rugged Metal I/O Connector
(MM mates to MK & MM)

BODY

- 1 1-Row (Sizes 4 thru 25)
 BODY STYLE:
- 2 Receptacle, straight
 BODY MATERIAL:
- 2 Electroless nickel shell w/ PPS insert
- 3 Electrodeposited cadmium shell w/ PPS insert
- 5 Stainless Steel shell w/ PPS insert

SIZE

XXX 004, 005, 006, 009, 012, 015, 021, 025

CONTACTS

- TYPE CONTACTS/TERMINATIONS:
- 21 Skt, straight, 26 awg solder cup
 - 2A Skt, straight, 24 awg solder cup
 - 22 Skt, straight, 0.150" pigtails (.018 dia)
 - 23 Skt, straight, 0.250" pigtails (.018 dia)
 - 24 Skt, straight, 0.500" pigtails (.018 dia)
 - 26 Skt, straight, crimped wire
- PLATING OPTIONS:
- 1 50 u" Au contacts (Crimped Wire)
 - 3 50 u" Au contacts; Au terminations (solder cup, pigtail)
 - 5 50 u" Au contacts; Sn/Pb alloy terminations (pigtail)
 - 7 50 u" Au contacts; SAC305 terminations (pigtail)

HARDWARE

- STYLE OF HARDWARE:
- 00 None
 - 22 Two fixed jacknut assemblies
 - 41 Two turning jackscrews, allen head, retaining ring
 - 45 Two turning jackscrews, allen head, captivated**

WIRING

XX For wiring codes, see page MA-3 & MA-4

900 Interfacial Seal

** = Captive hardware is factory installed and non-removable.
 = Option not RoHS compliant



Right Angle Boardmount (1 Row)

.050"

4 thru 25 Contacts

MK

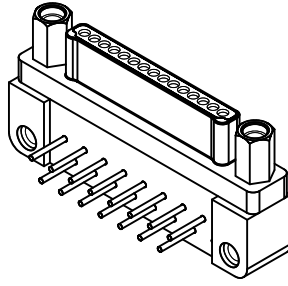

MK-152-015-325-220S
(PLUG)

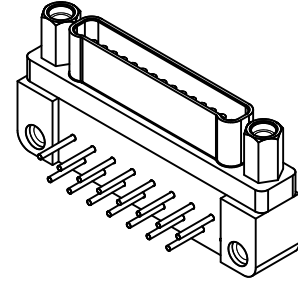

MK-162-015-435-220S
(RECEPTACLE)

MATING MATRIX	
CONNECTOR	MATES WITH
MK-15...	MM-12, MK-18 receptacles
MK-16...	MM-11, MK-17 plugs

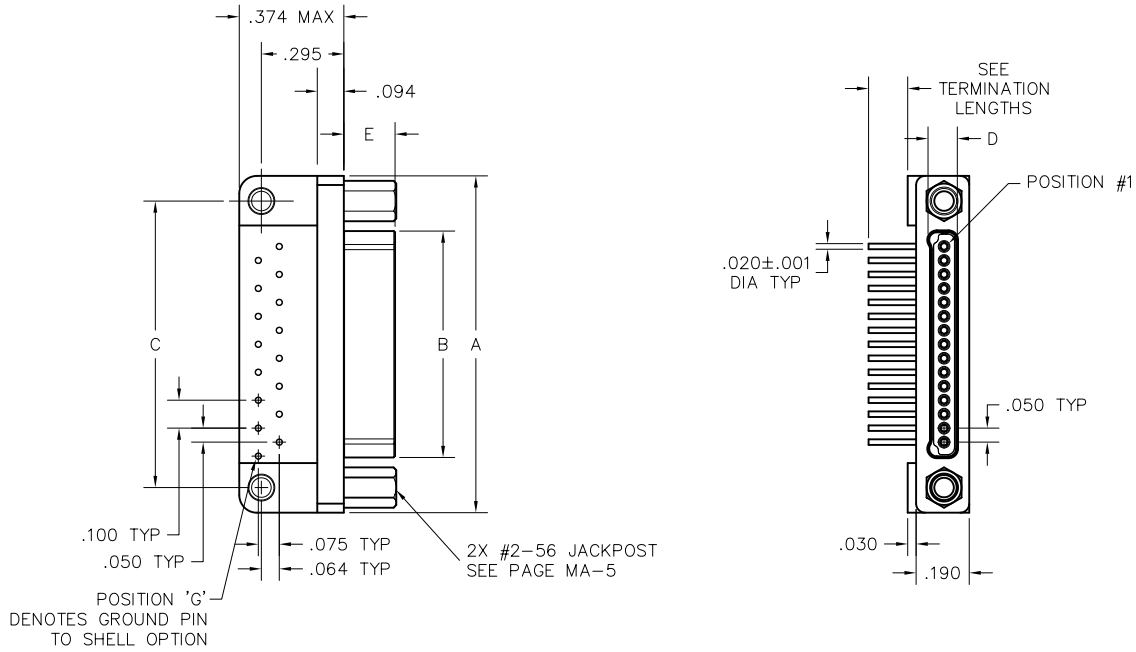

PLUG SHOWN

SIZE	A	B		C	D		E		MOUNTING HOLE
		PLUG MAX	RCPT MAX		PLUG MAX	RCPT MAX	PLUG MAX	RCPT MAX	
4	.655	.260	.297	.475	.110	.142	.186	.198	#2-56 CLEARANCE THRU OR #2-56 UNC THREADED INSERT
5	.705	.310	.347	.525					
6	.755	.360	.397	.575					
9	.905	.510	.547	.725					
12	1.055	.660	.697	.875					
15	1.205	.810	.847	1.025					
21	1.505	1.110	1.147	1.325					
25	1.705	1.310	1.347	1.525					

Call (972) 931-3200 Fax (972) 931-9305 www.AirBorn.com

PLUG: MK-152-006-325-220S
RECEPTACLE: MK-162-006-425-220S
 XX-XXX-XXX-XXX-XXXX-XXX
 | | | |
 BODY CONTACTS OPTIONS
 SERIES SIZE HARDWARE

PLUG

SERIES

MK .050" Rugged Metal Right Angle PTH Connector
(MK mates to MK & MM)

BODY

- 1 1-Row (Sizes 4 thru 25)
 BODY STYLE:
 5 Plug, right angle, standard footprint, with mounting holes
 BODY MATERIAL:
 2 Electroless nickel shell w/ PPS insert
 3 Electrodeposited cadmium shell w/ PPS insert
 5 Stainless Steel shell w/ PPS insert

SIZE

XXX 004, 005, 006, 009, 012, 015, 021, 025

CONTACTS

- TYPE CONTACTS/TERMINATIONS:
 32 Pin, right angle, pcb leads, .109"
 33 Pin, right angle, pcb leads, .140"
 34 Pin, right angle, pcb leads, .172"
 A2 Pin, right angle, pcb leads, .109" w/ ground pin option
 A3 Pin, right angle, pcb leads, .140" w/ ground pin option
 A4 Pin, right angle, pcb leads, .172" w/ ground pin option
 PLATING OPTIONS:
 3 50 u" Au contacts; Au terminations
 5 50 u" Au contacts; Sn/Pb alloy terminations
 7 50 u" Au contacts; SAC305 terminations

HARDWARE

- STYLE OF HARDWARE:
 00 None
 22 Two fixed jacknut assemblies
 POLARIZATION:
 0S Standard body polarization

OPTIONS

0B7 Threaded inserts, standard body polarization

= Option not RoHS compliant

RECEPTACLE

SERIES

MK .050" Rugged Metal Right Angle PTH Connector
(MM mates to MK & MM)

BODY

- 1 1-Row (Sizes 4 thru 25)
 BODY STYLE:
 6 Receptacle, right angle, standard footprint, with mounting holes
 BODY MATERIAL:
 2 Electroless nickel shell w/ PPS insert
 3 Electrodeposited cadmium shell w/ PPS insert
 5 Stainless Steel shell w/ PPS insert

SIZE

XXX 004, 005, 006, 009, 012, 015, 021, 025

CONTACTS

- TYPE CONTACTS/TERMINATIONS:
 43 Socket, right angle, pcb leads, .109"
 44 Socket, right angle, pcb leads, .140"
 45 Socket, right angle, pcb leads, .172"
 B3 Socket, right angle, pcb leads, .109" w/ ground pin option
 B4 Socket, right angle, pcb leads, .140" w/ ground pin option
 B5 Socket, right angle, pcb leads, .172" w/ ground pin option
 PLATING OPTIONS:
 3 50 u" Au contacts; Au terminations
 5 50 u" Au contacts; Sn/Pb alloy terminations
 7 50 u" Au contacts; SAC305 terminations

HARDWARE

- STYLE OF HARDWARE:
 00 None
 22 Two fixed jacknut assemblies
 POLARIZATION:
 0S Standard body polarization

900 Interfacial Seal
 0B7 Threaded inserts and interfacial sealing gasket,
 standard body polarization



Recommended PC Board Layout

RIGHT ANGLE
Standard Polarization
Pos 4 thru 9

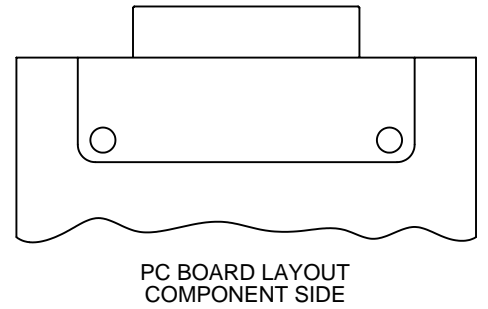
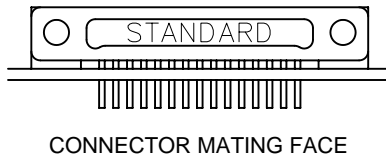

PLUG
PC BOARD LAYOUT
COMPONENT SIDE

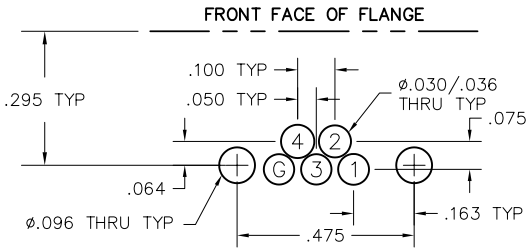

CONNECTOR
MATING FACE*
(RECEPTACLE)



RECEPTACLE
PC BOARD LAYOUT
COMPONENT SIDE

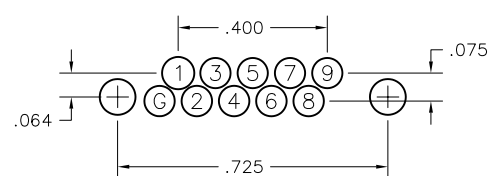
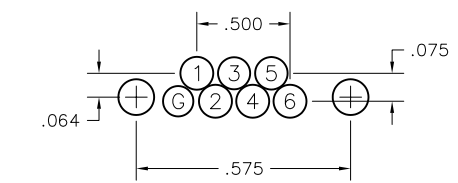
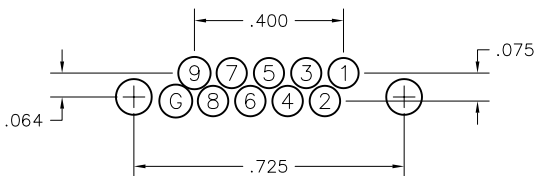
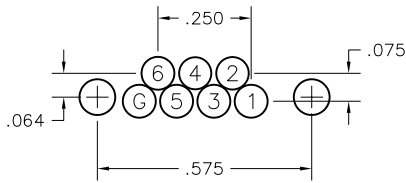
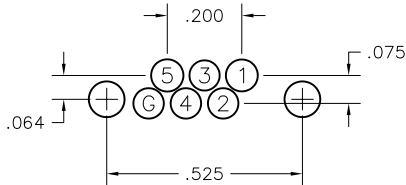
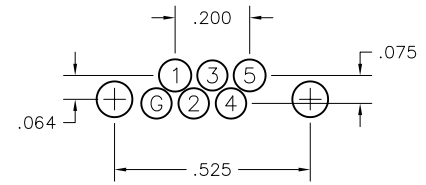
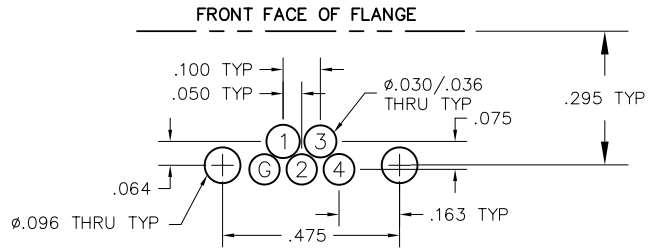

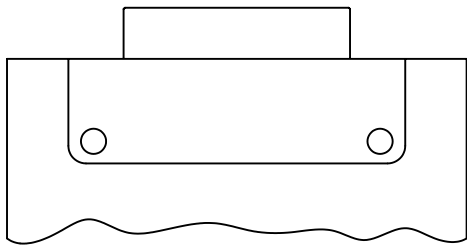

PC BOARD LAYOUT
COMPONENT SIDE



CONNECTOR MATING FACE



Recommended PC Board Layout

RIGHT ANGLE
Standard Polarization
Pos 12 thru 25

PLUG
PC BOARD LAYOUT
COMPONENT SIDE

RECEPTACLE
PC BOARD LAYOUT
COMPONENT SIDE

FRONT FACE OF FLANGE

FRONT FACE OF FLANGE

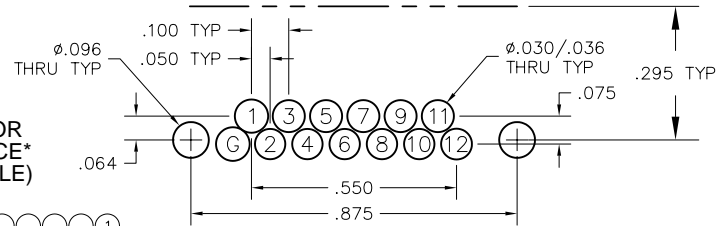
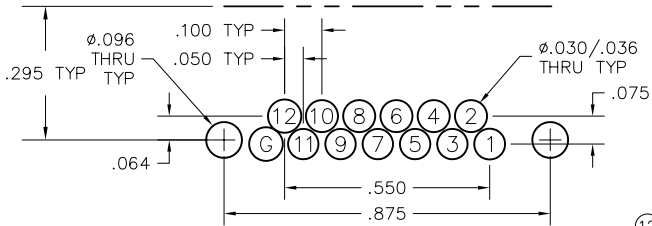

CONNECTOR
MATING FACE*
(RECEPTACLE)



12 POSITION

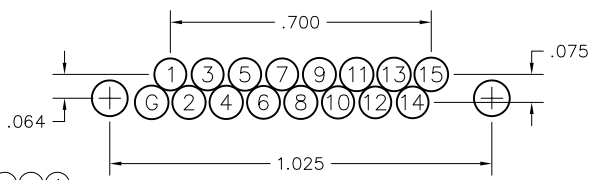
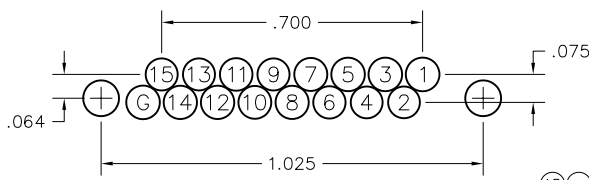

15 POSITION

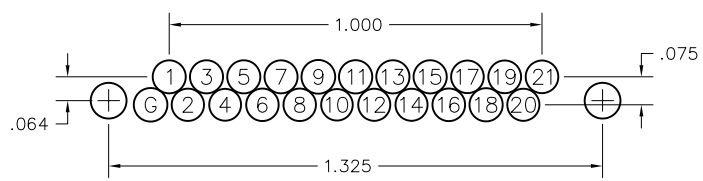
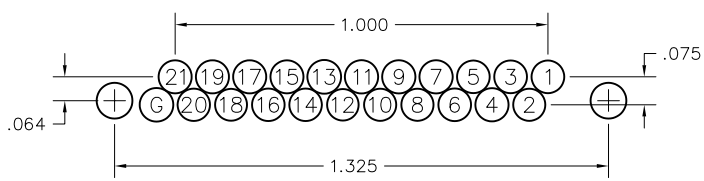

21 POSITION

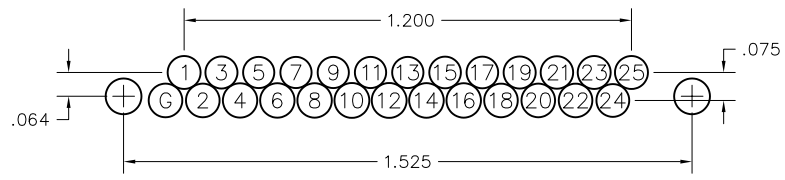
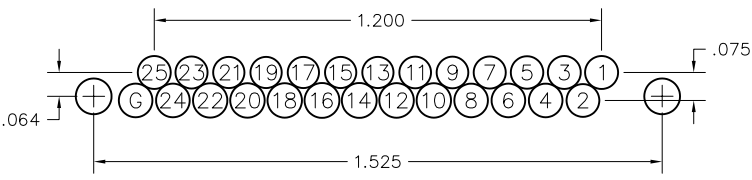

25 POSITION

Ask About AirBorn's Accelerated Delivery Service

Horizontal Surface Mount (1 Row)

.050"
4 thru 25 Contacts

MK

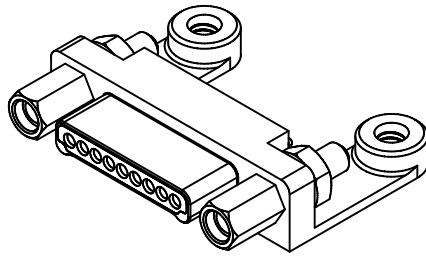

MK-172-009-175-220S
(PLUG)

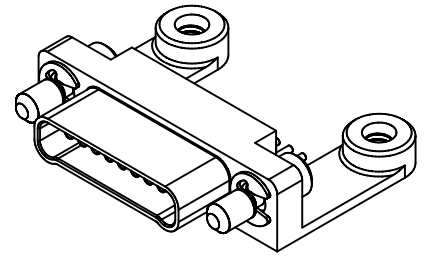

MK-182-009-275-410S
(RECEPTACLE)

MATING MATRIX	
CONNECTOR	MATES WITH
MK-17...	MM-12, MK-18 receptacles
MK-18...	MM-11, MK-17 plugs

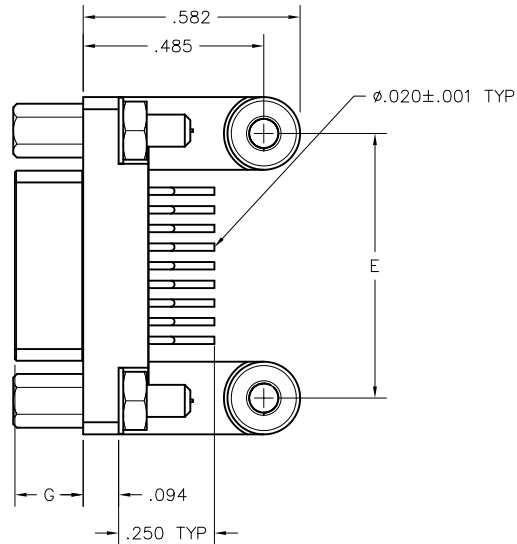
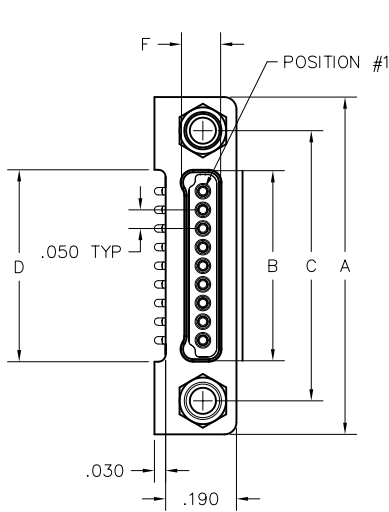

2X #2-56 JACKPOST
SEE PAGE MA-5

PLUG SHOWN

SIZE	DIMENSIONS										MOUNTING HOLE
	A	B		C	D	E	F		G		
		PLUG MAX	RCPT MAX				PLUG MAX	RCPT MAX	PLUG MAX	RCPT MAX	
4	.655	.260	.297	.475	.265	.460					
5	.705	.310	.347	.525	.315	.510					
6	.755	.360	.397	.575	.365	.560					
9	.905	.510	.547	.725	.515	.710					
12	1.055	.660	.697	.875	.665	.860	.110	.142	.186	.198	#2-56 THREAD THRU
15	1.205	.810	.847	1.025	.815	1.010					
21	1.505	1.110	1.147	1.325	1.115	1.310					
25	1.705	1.310	1.347	1.525	1.315	1.510					

PLUG: MK-172-006-175-220S
RECEPTACLE: MK-182-006-275-410S
 XX-XXX-XXX-XXX-XXXX-XXX
 | | | | |
 BODY CONTACTS OPTIONS
 SERIES SIZE HARDWARE

PLUG

SERIES

MK .050" Rugged Metal Horizontal SMT Connector
(MK mates to MK & MM)

BODY

- 1 1-Row (Sizes 4 thru 25)
 BODY STYLE:
7 Plug, Horizontal SMT
 BODY MATERIAL:
- 2 Electroless nickel shell w/ PPS insert
- 3 Electrodeposited cadmium shell w/ PPS insert
- 5 Stainless Steel shell w/ PPS insert

SIZE

XXX 004, 005, 006, 009, 012, 015, 021, 025

CONTACTS

- TYPE CONTACTS/TERMINATIONS:
- 17 Pin, surface mount
 PLATING OPTIONS:
- 3 50 u" Au contacts; Au terminations
- 5 50 u" Au contacts; Sn/Pb alloy terminations
- 7 50 u" Au contacts; SAC305 terminations

HARDWARE

- STYLE OF HARDWARE:
- 00 None
- 22 Two fixed jacknut assemblies
- 41 Two turning jackscrews, allen head, retaining ring
- POLARIZATION:
- 0S Standard body polarization

RECEPTACLE

SERIES

MK .050" Rugged Metal Horizontal SMT Connector
(MK mates to MK & MM)

BODY

- 1 1-Row (Sizes 4 thru 25)
 BODY STYLE:
- 8 Receptacle, Horizontal SMT
 BODY MATERIAL:
- 2 Electroless nickel shell w/ PPS insert
- 3 Electrodeposited cadmium shell w/ PPS insert
- 5 Stainless Steel shell w/ PPS insert

SIZE

XXX 004, 005, 006, 009, 012, 015, 021, 025

CONTACTS

- TYPE CONTACTS/TERMINATIONS:
- 27 Socket, surface mount
 PLATING OPTIONS:
- 3 50 u" Au contacts; Au terminations
- 5 50 u" Au contacts; Sn/Pb alloy terminations
- 7 50 u" Au contacts; SAC305 terminations

HARDWARE

- STYLE OF HARDWARE:
- 00 None
- 22 Two fixed jacknut assemblies
- 41 Two turning jackscrews, allen head, retaining ring
- POLARIZATION:
- 0S Standard body polarization

OPTIONS

= Option not RoHS compliant

900 Interfacial Seal



Recommended PC Board Layout

Horizontal SMT
1 ROW
Pos 4 thru 9



CONNECTOR MATING FACE

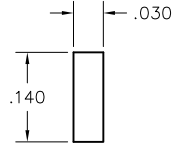

FOOTPRINT/PAD CONFIGURATION

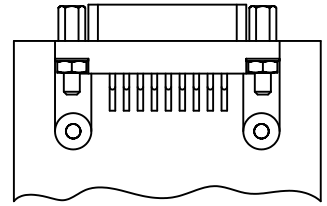

PC BOARD LAYOUT COMPONENT SIDE

PLUG
PC BOARD LAYOUT
COMPONENT SIDE

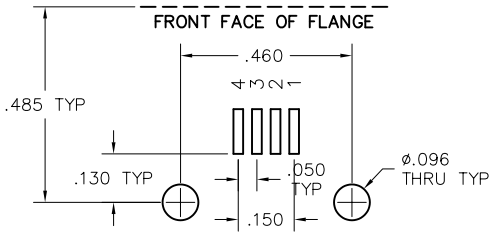

CONNECTOR
MATING FACE*
(RECEPTACLE)



RECEPTACLE
PC BOARD LAYOUT
COMPONENT SIDE

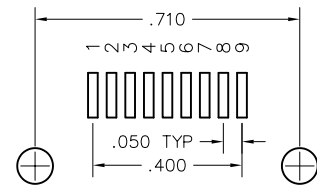
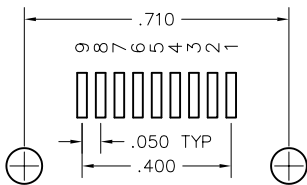
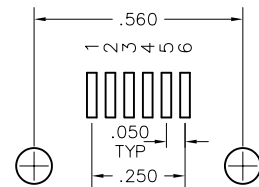
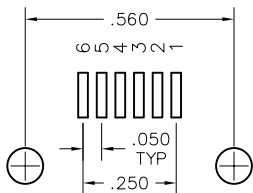
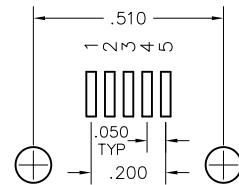
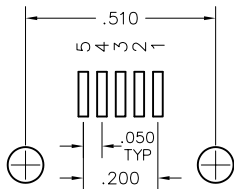
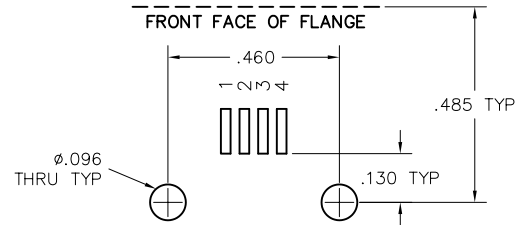



CONNECTOR MATING FACE

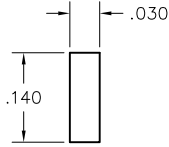

FOOTPRINT/PAD CONFIGURATION

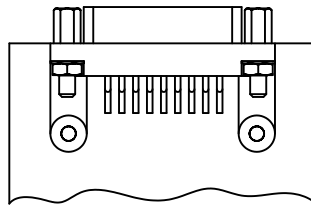

PC BOARD LAYOUT COMPONENT SIDE



Recommended PC Board Layout

Horizontal SMT
1 ROW
Pos 12 thru 25

PLUG
PC BOARD LAYOUT
COMPONENT SIDE

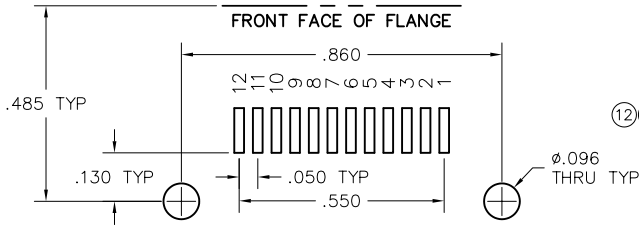

CONNECTOR MATING FACE* (RECEPTACLE)



12 POSITION

RECEPTACLE
PC BOARD LAYOUT
COMPONENT SIDE

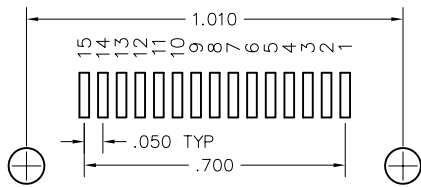
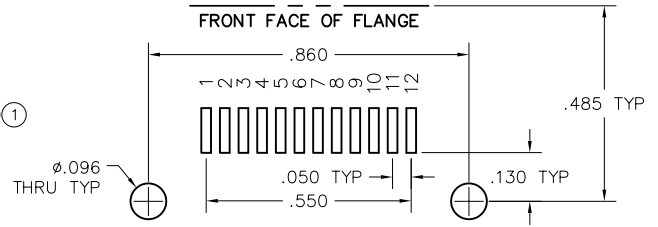

15 POSITION

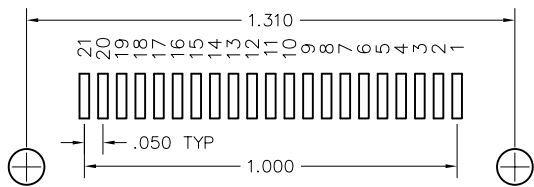
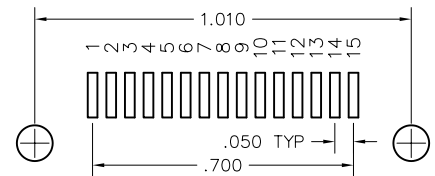

21 POSITION

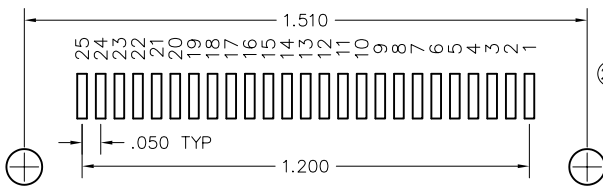
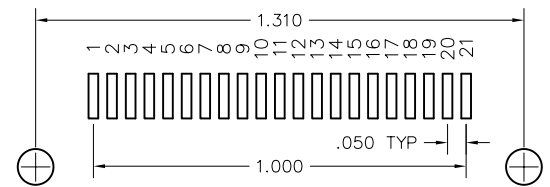

25 POSITION

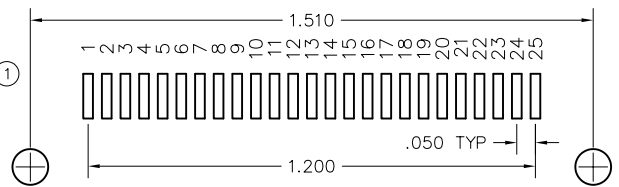

Ask About AirBorn's Accelerated Delivery Service

"MHT" SERIES - .050"
High Temperature

Contents

"MHT" Series

.050" Microminiature PCB and I/O Connectors, High Temperature

MHT-1	Contents
MHT-2	Specifications
MHT-3	Performance
MHT-4	Part number description
Micro-D, High Temperature, Cable to Cable Connectors (Metal)	
MHT-5	MMHT - MMHT Rugged
MHT-7	MQHT - MQHT Low profile
Micro-D, High Temperature, Board to Cable Connectors (Metal)	
MHT-9, 11	MKHT - MMHT Rugged right angle, narrow footprint
MHT-13	MKHT Board layouts - right angle, narrow footprint
MHT-15, 17	MSHT - MQHT Low profile right angle, narrow footprint
MHT-19	MSHT Board layouts - right angle, narrow footprint
MHT-21	MTHT - MTHT Low Profile right angle, radius, four mounting holes
MHT-23	MTHT Board layouts - right angle, radius, four mounting holes

Specifications

Materials and Finishes *

Contacts:	Pins: Copper based alloy selected for high temperature applications Sockets: Brass per ASTM B121 / B121M or ASTM B16 / B16M or ASTM B453
Contact Finish:	Gold plate per ASTM B488
Shells:	Aluminum Alloy 6061-T6 per SAE AMS-QQ-A-250/11 or 6061-T6511 per SAE AMS-QQ-A-200/8 Electroless Nickel per SAE AMS2404, Class 3, 500 μ " min
Molded Insulators:	High temperature thermoplastic
Embedment:	High temperature epoxy
Jackscrews, Jackposts and Nuts:	Corrosion resistant steel per ASTM A320 or ASTM A484 / A484M and ASTM A582 / A582M Passivated per SAE AMS2700
Clips and Washers:	Corrosion resistant steel per ASME 18.24 or NASM35333 (For reference only: ASME 18.24 CRS per ASTM A693 and NASM35333 CRS per ASTM A240) Passivated per ASME 18.24 or NASM35333 (For reference only: ASME 18.24 and NASM35333 passivated per SAE AMS2700)
Interfacial Seal Gaskets:	Fluorosilicone per SAE AMS-R-25988
Tolerances:	Unless otherwise specified: Fractions = $\pm 1/64$ " Decimals = ± 0.010 " Angles = $\pm 5^\circ$ Wire lengths: insulated/stranded = $+1.0"/-0.0$ " uninsulated/solid = $+0.2"/-0.0$ "

Note: AirBorn can manufacture special configurations for your exact specifications.

* = Reference the above listed specifications or an equivalent industry standard when applicable

Performance

Reference MIL-DTL-83513

AirBorn "M" Series meets or exceeds MIL-DTL-83513 Performance Specifications

Contact Rating:	3-amperes maximum
Solderability:	Terminals (except crimp) tested in accordance with MIL-STD-202, Method 208
Wire Size:	Stranded #24, #26, #28 AWG or solid #25 AWG standard (consult factory for other sizes and types)
Test Voltage:	600 V, RMS, 60 Hz
Operating Temperature:	-55° C to +205° C
Insulation Resistance:	5,000 megohms minimum @ 500 VDC
Durability:	500 connector mating cycles
Salt Spray:	Mated connectors tested in accordance with MIL-STD-1344, Method 1001, Test Condition B
Humidity:	Mated connectors tested in accordance with MIL-STD-1344, Method 1002, Type II (except steps 7a and 7b)
Thermal Shock:	Tested to the temperature extremes of MIL-STD-1344, Method 1003, Test Condition A (except step 3, temperature shall be 205° C)
Contact Resistance:	0.065 volt maximum drop @ 2.5 amps (.026 ohms)
Contact Engaging Force:	6.0 ounce maximum, with .0221 diameter test sleeve
Contact Separating Force:	0.5 ounce minimum, with .0230 diameter test sleeve
Crimp Strength:	5 pound minimum tensile strength

Part Number Description

Each part number consists of at least five elements: series, body description, size (number of contacts), type of contacts, and type of hardware. A sixth element is added whenever special modifications or options are available.

Each catalog page shows the choices available for each of these elements. By selecting one option from each category on the page, you can build a set of connectors to meet your requirements.

Each element is identified by a combination of letters and/or numbers in fixed field lengths, and separated by a hyphen (-). Each space must be filled in to complete the number. When the size, for example, is less than 100, indicate as 009, 051, etc.

Series:

This will always be a four letter designator which will identify the connector series. All .050" connectors begin with the letter "M". The second letter designates the various styles of .050" connectors. "HT" designates high temperature.

Body:

Each digit of the Body Designator will normally identify (1) the number of rows, (2) the style of body, and (3) the body materials. The three digit number to identify the body consists of one digit from each group.

Size:

The size is determined by the number of contacts in the connector, and is an integral part of the part number. Order only sizes shown on the catalog page unless otherwise noted.

Contacts:

Each page also identifies all contact options for a given connector. The first two digits designate the type of contacts and terminations; the third digit designates the plating option.

Hardware:

The hardware designator is four digits; two for style of hardware and two for polarization or wiring instruction. Follow the choices for each connector.

Special Instructions (Options):

Special instructions are referenced by a three digit number added to the end of the part number. The last three digits are included only when applicable. AirBorn will provide individual code numbers as needed.

Note:

Each page is as comprehensive as possible. However, if you do not find a particular connector size or option, please contact the factory for further assistance.



Cable to Cable

.050"

9 thru 100 Contacts

Rugged Metal
High Temperature

MMHT

MMHT-223-025-2A3-2200
(METAL)

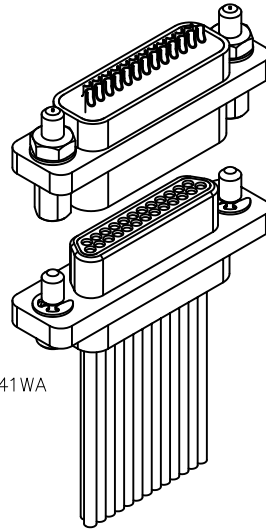

MMHT-212-025-161-41WA
(METAL)

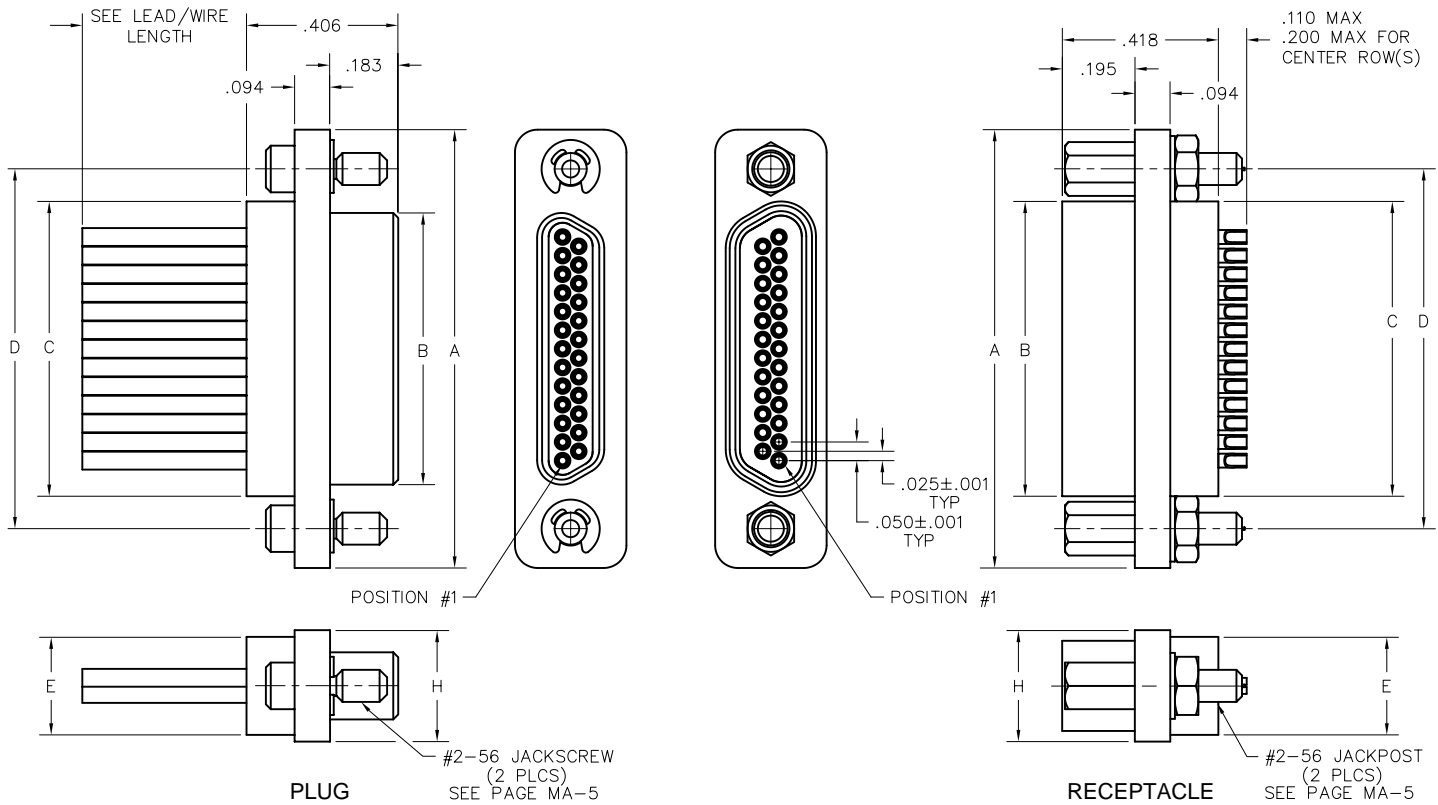

DIMENSIONS									
SIZE	CONTACT ROWS	A	B		C	D	E	H	HARDWARE
			PLUG MAX	RCPT MAX					
9	2	.775	.334	.400	.390	.565	.270	.298	#2-56 UNC THD (.092 DIA THRU)
15		.925	.484	.550	.540	.715			
21		1.075	.634	.700	.690	.865			
25		1.175	.734	.800	.790	.965			
31		1.325	.884	.950	.940	1.115			
37		1.475	1.034	1.100	1.090	1.265			
51	3	1.425	.984	1.050	1.040	1.215	.310	.341	#4-40 UNC THD (.147 DIA THRU)
100	4	2.160	1.384	1.508	1.432	1.800	.360	.384	

PLUG: MMHT-212-031-161-41WA
RECEPTACLE: MMHT-222-031-2G3-4500
 XXXX-XXX-XXX-XXX-XXXX

PLUG

RECEPTACLE

SERIES	
MMHT .050" Rugged Metal I/O Connector (MMHT mates with MMHT & MKHT receptacles)	MMHT .050" Rugged Metal I/O Connector (MMHT mates with MMHT & MKHT plugs)

BODY	
2 2-Row (Sizes 9 thru 51****)	2 2-Row (Sizes 9 thru 51****)
3 3-Row (Size 51 & 69***)	3 3-Row (Size 51 & 69***)
4 4-Row (Size 100)	4 4-Row (Size 100)

BODY STYLE:	
1 Plug, straight, with ears	2 Receptacle, straight, with ears and interfacial seal High temperature.

BODY MATERIAL:	
2 High temperature thermoplastic with electroless nickel shell	2 High temperature thermoplastic with electroless nickel shell

SIZE	
XXX 009, 015, 021, 025, 031, 037, 051, 100	XXX 009, 015, 021, 025, 031, 037, 051, 100

CONTACTS

TYPE CONTACTS/TERMINATIONS:

11 Pin, straight, 26 awg solder cup
1A Pin, straight, 24 awg solder cup
1D Pin, straight, .109" Lead Length (.018 dia) SEE NOTE 1
1E Pin, straight, .125" Lead Length (.018 dia) SEE NOTE 1
1F Pin, straight, .140" Lead Length (.018 dia) SEE NOTE 1
12 Pin, straight, .150" Lead Length (.018 dia) SEE NOTE 1
1G Pin, straight, .156" Lead Length (.018 dia) SEE NOTE 1
1H Pin, straight, .172" Lead Length (.018 dia) SEE NOTE 1
1J Pin, straight, .187" Lead Length (.018 dia) SEE NOTE 1
13 Pin, straight, .250" Lead Length (.018 dia) SEE NOTE 1
1K Pin, straight, .375" Lead Length (.018 dia) SEE NOTE 1
14 Pin, straight, .500" Lead Length (.018 dia) SEE NOTE 1
15 Pin, straight, 1.000" Lead Length (.018 dia) SEE NOTE 1
16 Pin, straight, crimped wire

TYPE CONTACTS/TERMINATIONS:

21 Socket, straight, 26 awg solder cup
2A Socket, straight, 24 awg solder cup
2D Socket, straight, .109" Lead Length (.018 dia)
2E Socket, straight, .125" Lead Length (.018 dia)
2F Socket, straight, .140" Lead Length (.018 dia)
22 Socket, straight, .150" Lead Length (.018 dia)
2G Socket, straight, .156" Lead Length (.018 dia)
2H Socket, straight, .172" Lead Length (.018 dia)
2J Socket, straight, .187" Lead Length (.018 dia)
23 Socket, straight, .250" Lead Length (.018 dia)
2K Socket, straight, .375" Lead Length (.018 dia)
2L Socket, straight, .500" Lead Length (.018 dia)
2M Socket, straight, 1.000" Lead Length (.018 dia)
24 Socket, straight, .500" Lead Length (.018 dia) SEE NOTE 1
25 Socket, straight, 1.000" Lead Length (.018 dia) SEE NOTE 1
26 Socket, straight, crimped wire

PLATING OPTIONS:

1 50 μ" Au contacts (crimp wire)
3 50 μ" Au contacts (solder cup, pigtail)

PLATING OPTIONS:

1 50 μ" Au contacts (crimp wire)
3 50 μ" Au contacts (solder cup, pigtail)

HARDWARE

STYLE OF HARDWARE:

00 None
22 Two fixed jacknut assemblies (62*)
41 Two turning jackscrews, allen head, retaining ring (81*)
42 Two long turning jackscrews, allen head, retaining ring (82*)
43 Two turning jackscrews, slot head, retaining ring (83*)
44 Two long turning jackscrews, slot head, retaining ring (84*)
45 Two turning jackscrews, allen head, captivated** (85*)

STYLE OF HARDWARE:

00 None
22 Two fixed jacknut assemblies (62*)
41 Two turning jackscrews, allen head, retaining ring (81*)
42 Two long turning jackscrews, allen head, retaining ring (82*)
43 Two turning jackscrews, slot head, retaining ring (83*)
44 Two long turning jackscrews, slot head, retaining ring (84*)
45 Two turning jackscrews, allen head, captivated** (85*)

POLARIZATION / WIRING

00 None
XX For wiring codes, see page MA-3 & MA-4

POLARIZATION / WIRING

00 None
XX For wiring codes, see page MA-3 & MA-4

* = Use numbers or letters in parenthesis when ordering size 100.
 ** = Captive hardware is factory installed and non-removable.

NOTE 1 = The leads on these contacts are soft copper suitable for forming.

Cable to Cable

.050"

9 thru 51 Contacts

Low Profile Metal
High Temperature

MQHT

MQHT-222-031-2A3-2200
(METAL)

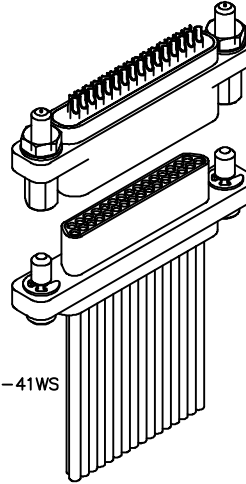

MQHT-212-031-161-41WS
(METAL)

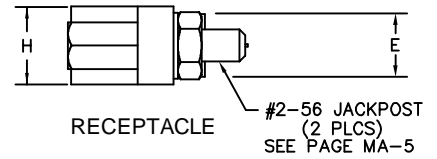
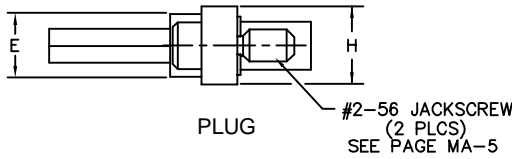
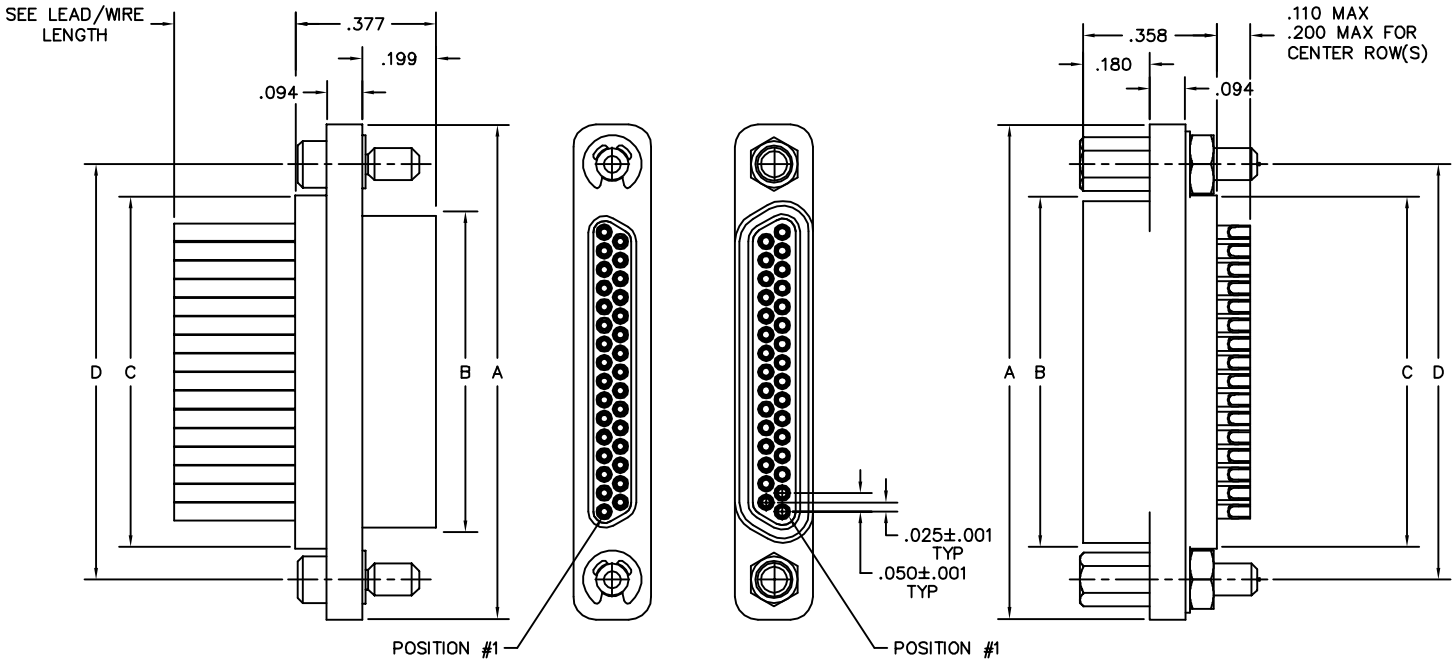

SIZE	CONTACT ROWS	DIMENSIONS							H	HARDWARE
		A	B		C	D	E			
			PLUG MAX	RCPT MAX				POTTING WELL MAX		
9	2	.778	.292	.378	.398	.565	.173	.208	#2-56 UNC THD (.092 DIA THRU)	
15		.928	.442	.528	.548	.715				
21		1.078	.592	.678	.698	.865				
25		1.178	.692	.778	.798	.965				
31		1.328	.842	.928	.948	1.115				
37	1.478	.992	1.078	1.098	1.265					
51	3	1.428	.942	1.028	1.048	1.215	.220	.250		

PLUG: MQHT-212-031-161-41WS
RECEPTACLE: MQHT-222-031-2G3-4500
 XXXX-XXX-XXX-XXX-XXXX

PLUG

RECEPTACLE

SERIES	
MQHT .050" Low Profile Metal I/O Connector (MQHT mates with MQHT & MSHT receptacles)	MQHT .050" Low Profile Metal I/O Connector (MQHT mates with MQHT & MSHT receptacles)
BODY	
2 2-Row (Sizes 9 thru 37)	2 2-Row (Sizes 9 thru 37)
3 3-Row (Size 51)	3 3-Row (Size 51)
BODY STYLE:	BODY STYLE:
1 Plug, straight, with ears. High Temperature.	2 Receptacle, straight, with ears. High temperature.
BODY MATERIAL:	BODY MATERIAL:
2 High temperature thermoplastic with electroless nickel shell	2 High temperature thermoplastic with electroless nickel shell
SIZE	
XXX 009, 015, 021, 025, 031, 037, 051	XXX 009, 015, 021, 025, 031, 037, 051
CONTACTS	
TYPE CONTACTS/TERMINATIONS:	TYPE CONTACTS/TERMINATIONS:
11 Pin, straight, 26 awg solder cup	21 Socket, straight, 26 awg solder cup
1A Pin, straight, 24 awg solder cup	2A Socket, straight, 24 awg solder cup
1D Pin, straight, .109" Lead Length (.018 dia) SEE NOTE 1	2D Socket, straight, .109" Lead Length (.018 dia)
1E Pin, straight, .125" Lead Length (.018 dia) SEE NOTE 1	2E Socket, straight, .125" Lead Length (.018 dia)
1F Pin, straight, .140" Lead Length (.018 dia) SEE NOTE 1	2F Socket, straight, .140" Lead Length (.018 dia)
12 Pin, straight, .150" Lead Length (.018 dia) SEE NOTE 1	22 Socket, straight, .150" Lead Length (.018 dia)
1G Pin, straight, .156" Lead Length (.018 dia) SEE NOTE 1	2G Socket, straight, .156" Lead Length (.018 dia)
1H Pin, straight, .172" Lead Length (.018 dia) SEE NOTE 1	2H Socket, straight, .172" Lead Length (.018 dia)
1J Pin, straight, .187" Lead Length (.018 dia) SEE NOTE 1	2J Socket, straight, .187" Lead Length (.018 dia)
13 Pin, straight, .250" Lead Length (.018 dia) SEE NOTE 1	23 Socket, straight, .250" Lead Length (.018 dia)
1K Pin, straight, .375" Lead Length (.018 dia) SEE NOTE 1	2K Socket, straight, .375" Lead Length (.018 dia)
14 Pin, straight, .500" Lead Length (.018 dia) SEE NOTE 1	2L Socket, straight, .500" Lead Length (.018 dia)
15 Pin, straight, 1.000" Lead Length (.018 dia) SEE NOTE 1	2M Socket, straight, 1.000" Lead Length (.018 dia)
16 Pin, straight, crimped wire	24 Socket, straight, .500" Lead Length (.018 dia) SEE NOTE 1
	25 Socket, straight, 1.000" Lead Length (.018 dia) SEE NOTE 1
	26 Socket, straight, crimped wire
PLATING OPTIONS:	PLATING OPTIONS:
1 50 μ" Au contacts (crimp wire)	1 50 μ" Au contacts (crimp wire)
3 50 μ" Au contacts: 10 μ" Au terminations (solder cup, pigtail)	3 50 μ" Au contacts: 10 μ" Au terminations (solder cup, pigtail)
HARDWARE	
STYLE OF HARDWARE:	STYLE OF HARDWARE:
00 None	00 None
22 Two fixed jacknut assemblies	22 Two fixed jacknut assemblies
41 Two turning jackscrews, allen head, retaining ring	41 Two turning jackscrews, allen head, retaining ring
42 Two long turning jackscrews, allen head, retaining ring	42 Two long turning jackscrews, allen head, retaining ring
43 Two turning jackscrews, slot head, retaining ring	43 Two turning jackscrews, slot head, retaining ring
44 Two long turning jackscrews, slot head, retaining ring	44 Two long turning jackscrews, slot head, retaining ring
45 Two turning jackscrews, allen head, captivated*	45 Two turning jackscrews, allen head, captivated*
POLARIZATION / WIRING	POLARIZATION / WIRING
00 None	00 None
XX For wiring codes, see page MA-3 & MA-4	XX For wiring codes, see page MA-3 & MA-4

* = Captive hardware is factory installed and non-removable.

NOTE 1 = The leads on these contacts are soft copper suitable for forming.



Board (Narrow Footprint) to Cable

.050"

9 thru 100 Contacts

Rugged Board Mount

High Temperature

MKHT

Rugged Cable

High Temperature

MMHT

MKHT-262-031-443-220S
(METAL)

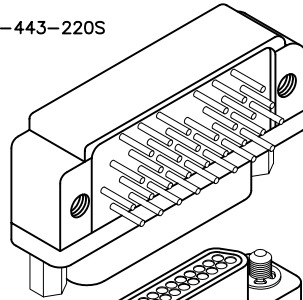

MMHT-212-031-113-4300
(METAL)

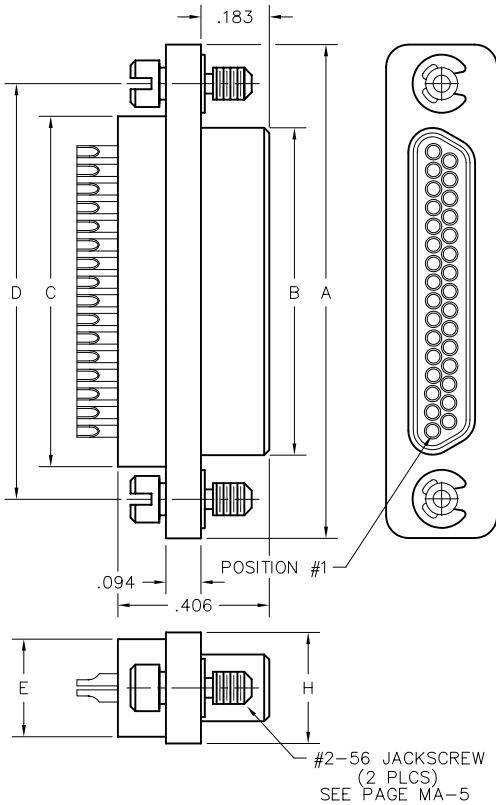
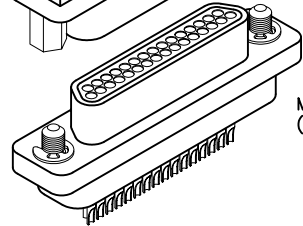

PLUG

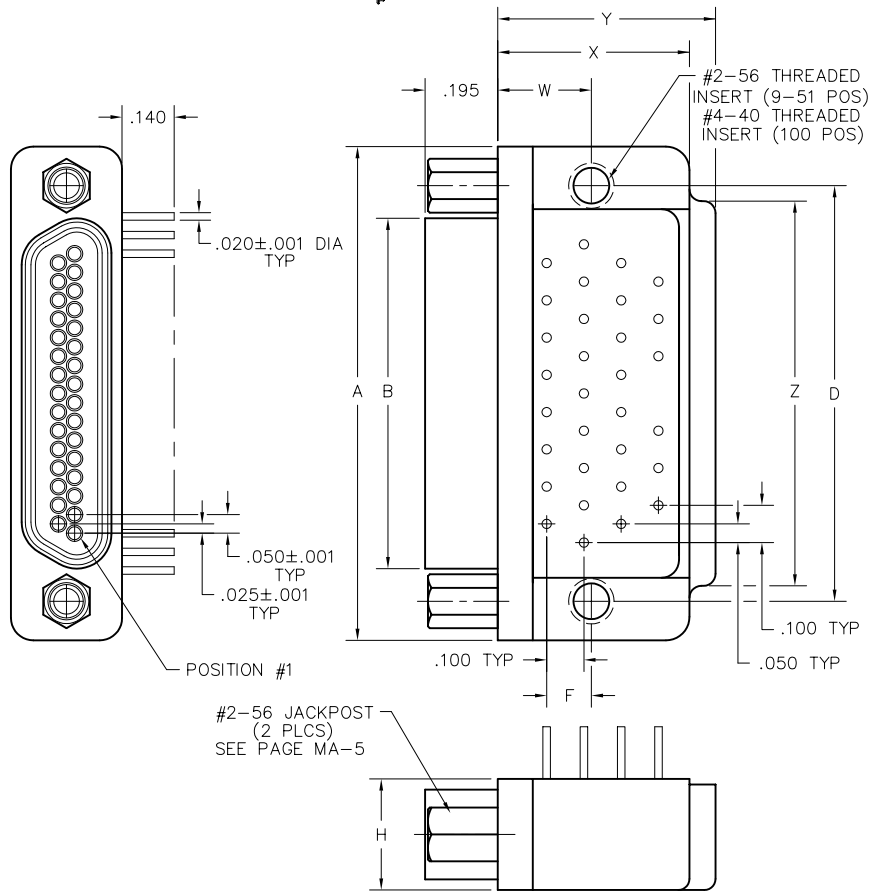

RECEPTACLE

SIZE	CONTACT ROWS	DIMENSIONS												HARDWARE	
		A	B		C	D	E		F	H	W	X MAX	Y MAX		Z
			PLUG MAX	RCPT MAX			POTTING WELL MAX								
9	2	.775	.334	.400	.390	.565	.270	.120	.298	.250	.420	.420	.775	#2-56 UNC THD	
15		.925	.484	.550	.540	.715							.925		
21		1.075	.634	.700	.690	.865							1.075		
25		1.175	.734	.800	.790	.965							1.175		
31		1.325	.884	.950	.940	1.115							1.325		
37	1.475	1.034	1.100	1.090	1.265	1.475	.450	.520	1.080	1.180					
51	3	1.425	.984	1.050	1.040	1.215	.310	.150	.341	.300	.430	.650	1.220	#4-40 UNC THD	
100	4	2.160	1.384	1.508	1.432	1.800	.360	.200	.384	.400	.590	1.000	1.810		

PLUG: MMHT- 212 - 031 - 113 - 4300
RECEPTACLE: MKHT- 262 - 031 - 443 - 220S
 XXXX - XXX - XXX - XXX - XXXX

PLUG

RECEPTACLE

SERIES	
MMHT .050" Rugged Metal I/O Connector (MMHT mates with MMHT & MKHT receptacles)	MKHT .050" Rugged Metal PC Board Mount Connector (MKHT mates with MMHT plugs)
BODY	
2 2-Row (Sizes 9 thru 37) 3 3-Row (Size 51) 4 4-Row (Size 100)	2 2-Row (Sizes 9 thru 37) 3 3-Row (Size 51) 4 4-Row (Size 100)
BODY STYLE: 1 Plug, straight, with ears. High temperature.	BODY STYLE: 6 Receptacle, right angle, narrow footprint, w/ threaded inserts and interfacial seal. High temperature.
BODY MATERIAL: 2 High temperature thermoplastic with electroless nickel shell	BODY MATERIAL: 2 High temperature thermoplastic with electroless nickel shell
SIZE	
XXX 009, 015, 021, 025, 031, 037, 051, 100	XXX 009, 015, 021, 025, 031, 037, 051, 100
CONTACTS	
TYPE CONTACTS/TERMINATIONS: 11 Pin, straight, solder cup 14 Pin, straight, .500" pigtails (.018 dia) 15 Pin, straight, 1.000" pigtails (.018 dia) 16 Pin, straight, crimped wire	TYPE CONTACTS/TERMINATIONS: 43 Socket, right angle, dip solder, .109" x .020" dia 44 Socket, right angle, dip solder, .140" x .020" dia 45 Socket, right angle, dip solder, .172" x .020" dia
PLATING OPTIONS: 1 50 μ" Au contacts (crimp wire) 3 50 μ" Au contacts: 10 μ" Au terminations (solder cup, pigtail)	PLATING OPTIONS: 3 50 μ" Au contacts: 10 μ" Au terminations
HARDWARE	
STYLE OF HARDWARE: 00 None 41 Two turning jackscrews, allen head, retaining ring (81*) 42 Two long turning jackscrews, allen head, retaining ring (82*) 43 Two turning jackscrews, slot head, retaining ring (83*) 44 Two long turning jackscrews, slot head, retaining ring (84*) 45 Two turning jackscrews, allen head, captivated** (85*)	STYLE OF HARDWARE: 00 None 22 Two fixed jacknut assemblies (62*)
POLARIZATION / WIRING: 00 None XX For wiring codes, see page MA-3 & MA-4	POLARIZATION / WIRING: 0S Standard body polarization

* = Use number in parenthesis when ordering size 100.
 ** = Captive hardware is factory installed and non-removable.



MKHT-252-031-335-220S
(METAL)

Board (Narrow Footprint) to Cable

.050"

9 thru 100 Contacts

Rugged Board Mount
High Temperature

MKHT

Rugged Cable
High Temperature

MMHT

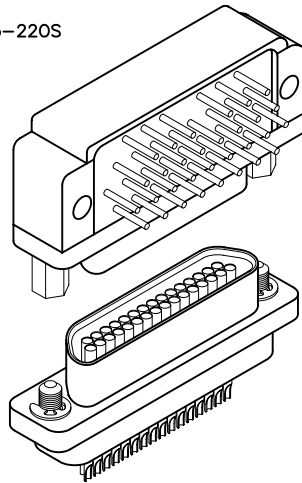

MMHT-222-031-213-4100
(METAL)

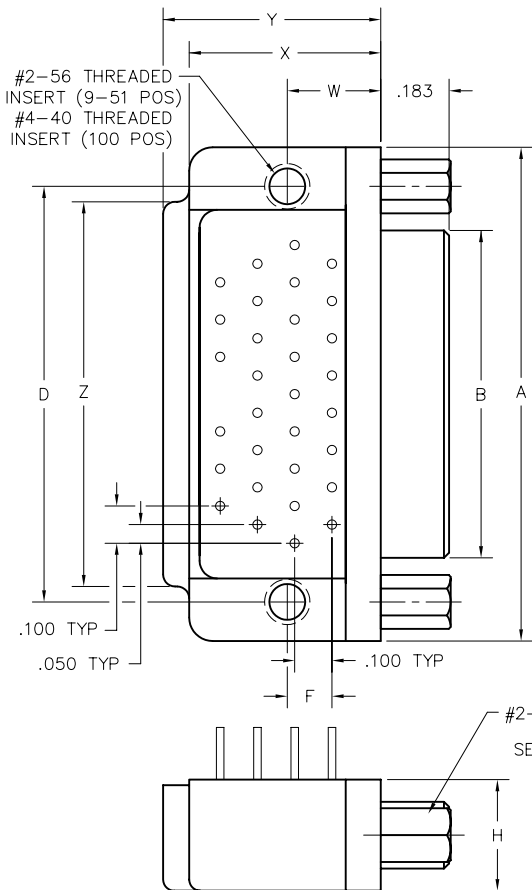

PLUG

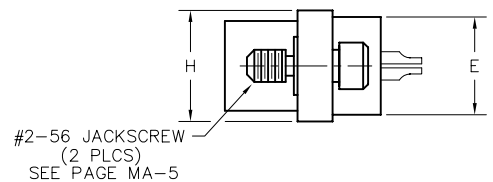
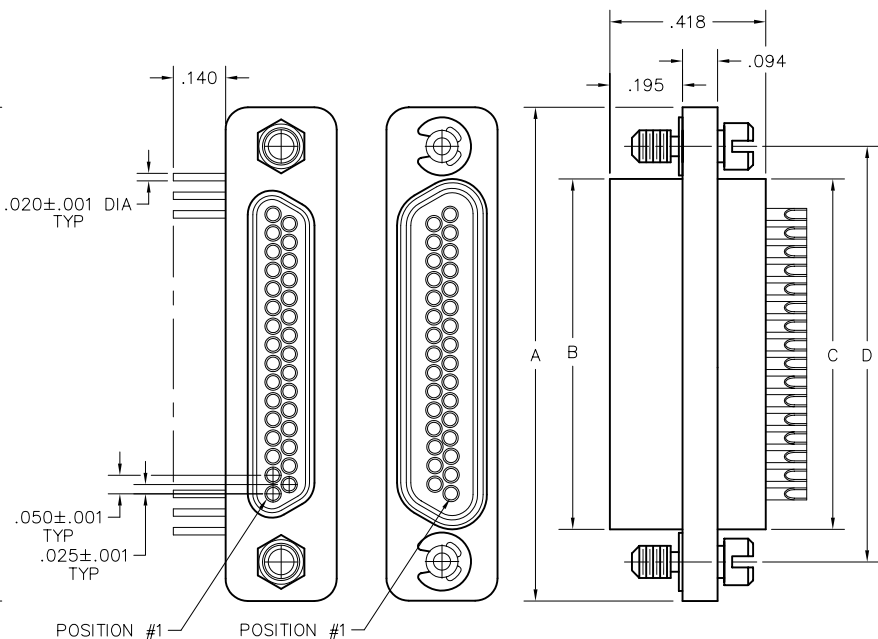

RECEPTACLE

SIZE	CONTACT ROWS	DIMENSIONS												HARDWARE
		A	B		C	D	E	F	H	W	X MAX	Y MAX	Z	
			PLUG MAX	RCPT MAX										
9	2	.775	.334	.400	.390	.565	.270	.120	.298	.250	.420	.420	.775	#2-56 UNC THD
15		.925	.484	.550	.540	.715							.925	
21		1.075	.634	.700	.690	.865							1.075	
25		1.175	.734	.800	.790	.965							1.175	
31		1.325	.884	.950	.940	1.115							1.080	
37	1.475	1.034	1.100	1.090	1.265	1.180								
51	3	1.425	.984	1.050	1.040	1.215	.310	.150	.341	.300	.430	.650	1.220	#4-40 UNC THD
100	4	2.160	1.384	1.508	1.432	1.800	.360	.200	.384	.400	.590	1.000	1.810	

PLUG: MKHT-252-031-335-220S
 RECEPTACLE: MMHT-222-031-213-4100
 XXXX-XXX-XXX-XXX-XXXX-XXX

PLUG

RECEPTACLE

SERIES

MKHT .050" Rugged Metal PC Board Mount Connector (MKHT mates with MMHT receptacles)	MMHT .050" Rugged Metal I/O Connector (MMHT mates with MKHT & MMHT plugs)
---	---

BODY

2 2-Row (Sizes 9 thru 37)	2 2-Row (Sizes 9 thru 37)
3 3-Row (Size 51)	3 3-Row (Size 51)
4 4-Row (Size 100)	4 4-Row (Size 100)
BODY STYLE: 5 Plug, right angle, narrow footprint, w/ threaded inserts. High temperature.	BODY STYLE: 2 Receptacle, straight, with ears. High temperature.
BODY MATERIAL: 2 High temperature thermoplastic with electroless nickel shell	BODY MATERIAL: 2 High temperature thermoplastic with electroless nickel shell

SIZE

XXX 009, 015, 021, 025, 031, 037, 051, 100	XXX 009, 015, 021, 025, 031, 037, 051, 100
--	--

CONTACTS

TYPE CONTACTS/TERMINATIONS: 32 Pin, right angle, dip solder, .109" 33 Pin, right angle, dip solder, .140" 34 Pin, right angle, dip solder, .172"	TYPE CONTACTS/TERMINATIONS: 21 Socket, straight, solder cup 24 Socket, straight, .500" pigtails (.018 dia) 25 Socket, straight, 1.000" pigtails (.018 dia) 26 Socket, straight, crimped wire
PLATING OPTIONS: 3 50 μ" Au contacts: 10 μ" Au terminations	PLATING OPTIONS: 1 50 μ" Au contacts (crimp wire) 3 50 μ" Au contacts: 10 μ" Au terminations (solder cup, pigtail)

HARDWARE

STYLE OF HARDWARE: 00 None 22 Two fixed jacknut assemblies (62*)	STYLE OF HARDWARE: 00 None 41 Two turning jackscrews, allen head, retaining ring (81*) 42 Two long turning jackscrews, allen head, retaining ring (82*) 43 Two turning jackscrews, slot head, retaining ring (83*) 44 Two long turning jackscrews, slot head, retaining ring (84*) 45 Two turning jackscrews, allen head, captivated** (85*)
POLARIZATION / WIRING: 0S Standard body polarization	POLARIZATION / WIRING: 00 None XX For wiring codes, see page MA-3 & MA-4

OPTIONS

900 Interfacial sealing gasket

* = Use number in parenthesis when ordering size 100.
 ** = Captive hardware is factory installed and non-removable.



Recommended PC Board Layout

Right Angle, Narrow Footprint
Standard Polarization

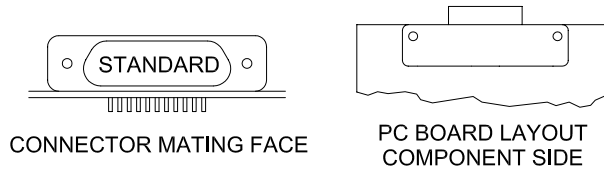

CONNECTOR MATING FACE (RECEPTACLE)

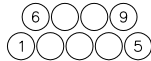

9 POSITION

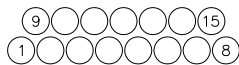

15 POSITION



21 POSITION



25 POSITION



31 POSITION



37 POSITION



51 POSITION



100 POSITION

RECEPTACLE PC BOARD LAYOUT COMPONENT SIDE

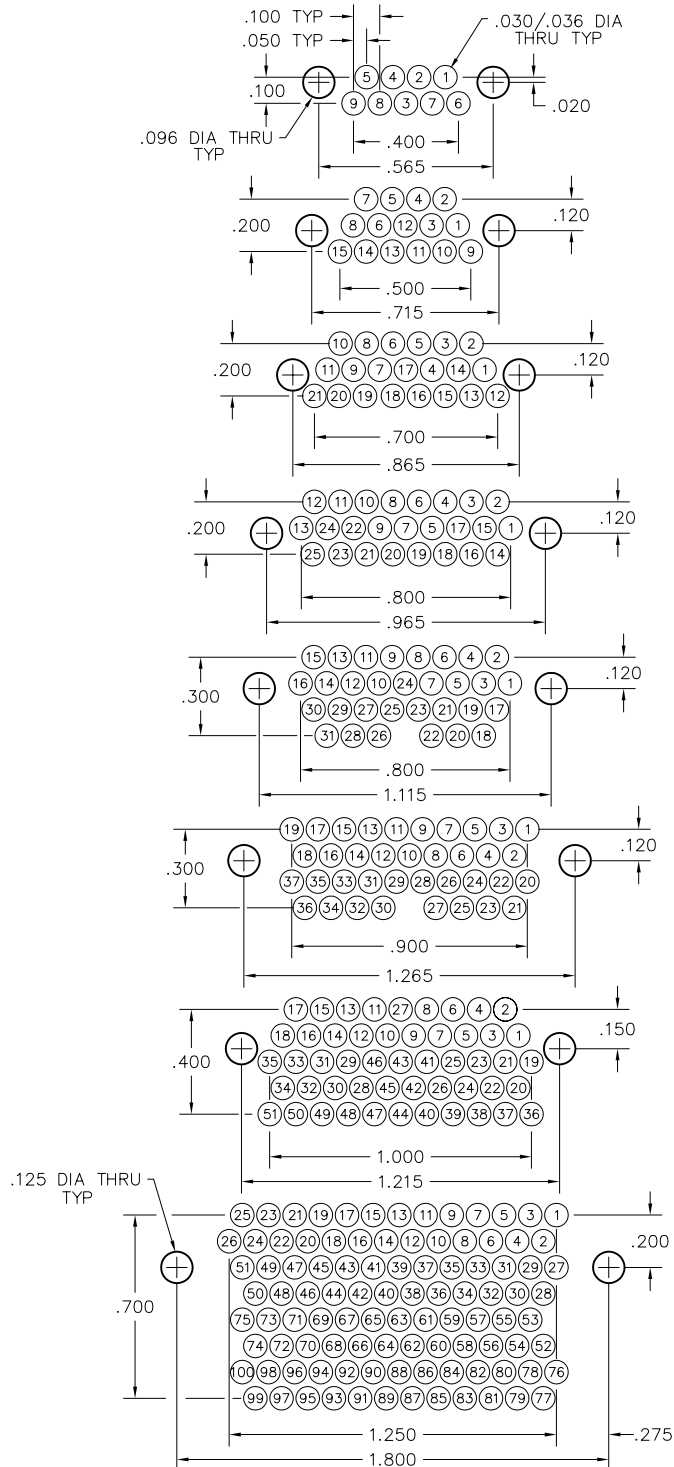

Recommended PC Board Layout

Right Angle, Narrow Footprint
Standard Polarization

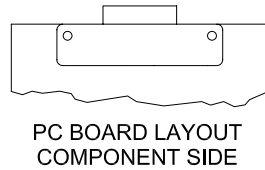
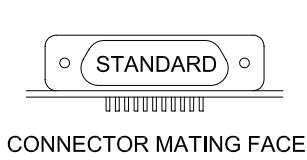

CONNECTOR MATING FACE (PLUG)

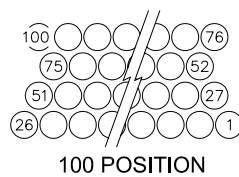
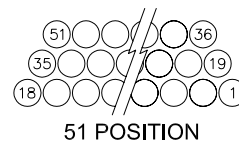
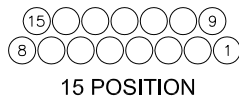
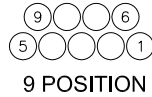

PLUG PC BOARD LAYOUT COMPONENT SIDE

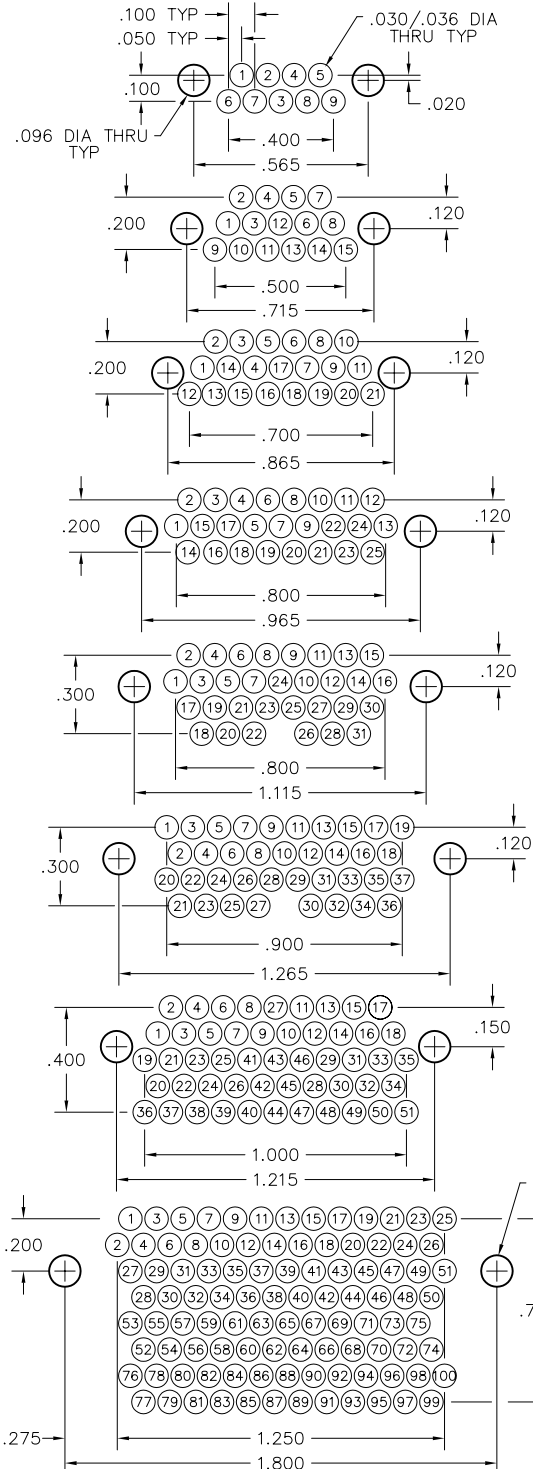



MSHT-262-037-435-220S
(METAL)

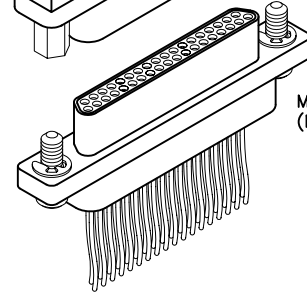
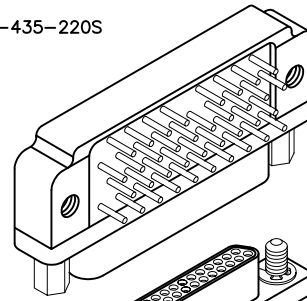

MQHT-212-037-161-41WS
(METAL)

Board (Narrow Footprint) to Cable

.050"

9 thru 51 Contacts

Low Profile Board Mount

High Temperature

MSHT

Low Profile Cable

High Temperature

MQHT

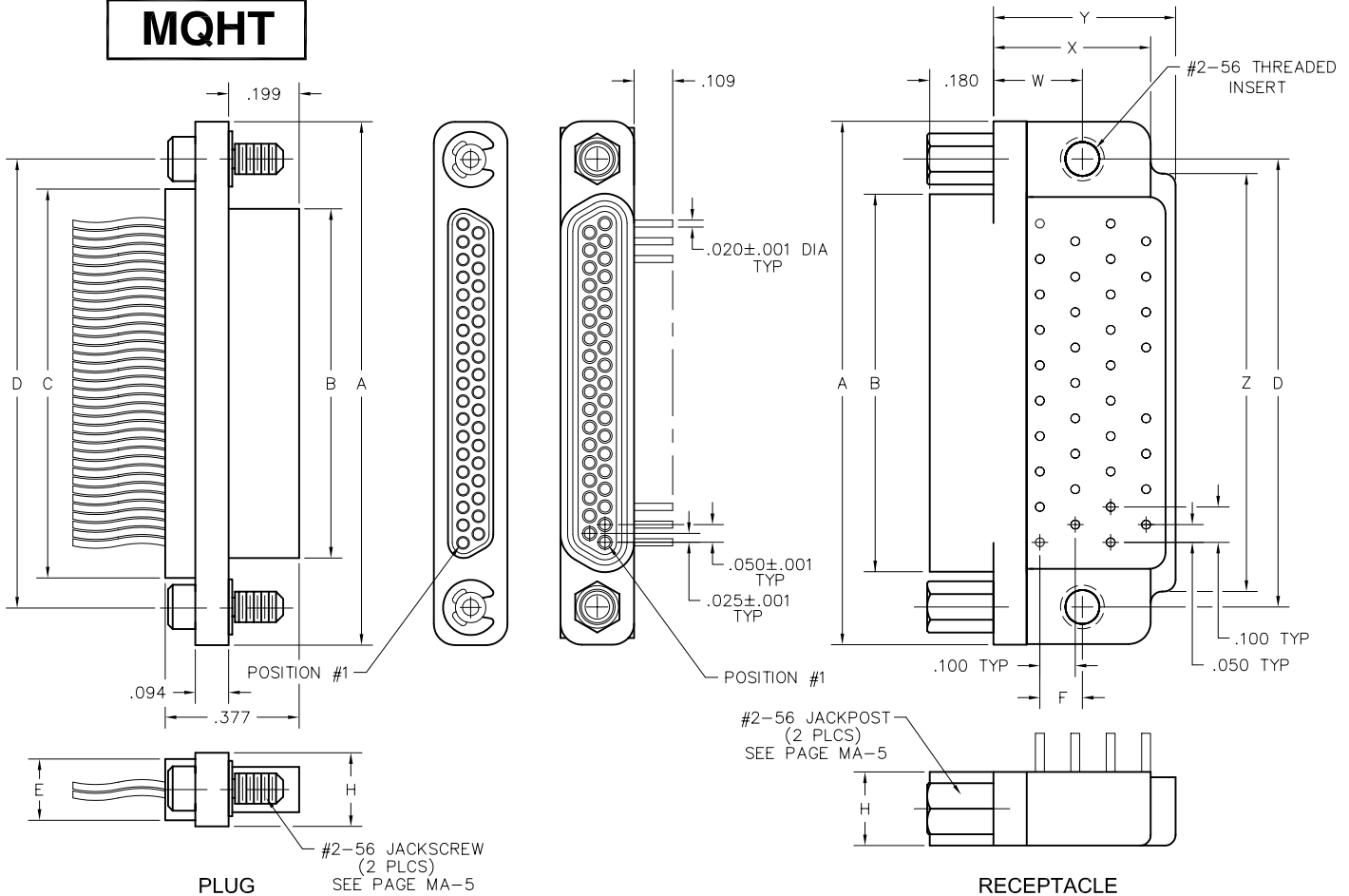

DIMENSIONS															
SIZE	CONTACT ROWS	A	B		C	D	E		F	H	W	X MAX	Y MAX	Z	HARDWARE
			PLUG MAX	RCPT MAX			POTTING WELL MAX								
9	2	.778	.292	.378	.398	.565	.173	.120	.208	.250	.420	.420	.775	#2-56 UNC THD	
15		.928	.442	.528	.548	.715									
21		1.078	.592	.678	.698	.865									
25		1.178	.692	.778	.798	.965									
31		1.328	.842	.928	.948	1.115									
37		1.478	.992	1.078	1.098	1.265									
51	3	1.428	.942	1.028	1.048	1.215	.220	.150	.250	.300	.425	.650	1.220		

PLUG: MQHT-212-037-161-41WS
RECEPTACLE: MSHT-262-037-433-220S
 XXXX-XXX-XXX-XXX-XXXX

PLUG		RECEPTACLE	
SERIES			
MQHT .050" Low Profile Metal I/O Connector (MQHT mates with MQHT & MSHT receptacles)		MSHT .050" Low Profile Metal PC Board Mount Connector (MSHT mates with MQHT plugs)	
BODY			
2 2-Row (Sizes 9 thru 37)	3 3-Row (Size 51)	2 2-Row (Sizes 9 thru 37)	3 3-Row (Size 51)
BODY STYLE: 1 Plug, straight, with ears. High temperature.		BODY STYLE: 6 Receptacle, right angle, narrow footprint, w/ threaded inserts. High temperature.	
BODY MATERIAL: 2 High temperature thermoplastic with electroless nickel shell		BODY MATERIAL: 2 High temperature thermoplastic with electroless nickel shell	
SIZE			
XXX 009, 015, 021, 025, 031, 037, 051		XXX 009, 015, 021, 025, 031, 037, 051	
CONTACTS			
TYPE CONTACTS/TERMINATIONS: 11 Pin, straight, solder cup 14 Pin, straight, .500" pigtails (.018 dia) 15 Pin, straight, 1.000" pigtails (.018 dia) 16 Pin, straight, crimped wire		TYPE CONTACTS/TERMINATIONS: 43 Socket, right angle, dip solder, .109" x .020" dia 44 Socket, right angle, dip solder, .140" x .020" dia 45 Socket, right angle, dip solder, .172" x .020" dia	
PLATING OPTIONS: 1 50 μ" Au contacts (crimp wire) 3 50 μ" Au contacts: 10 μ" Au terminations (solder cup, pigtail)		PLATING OPTIONS: 3 50 μ" Au contacts: 10 μ" Au terminations	
HARDWARE			
STYLE OF HARDWARE: 00 None 41 Two turning jackscrews, allen head, retaining ring 42 Two long turning jackscrews, allen head, retaining ring 43 Two turning jackscrews, slot head, retaining ring 44 Two long turning jackscrews, slot head, retaining ring 45 Two turning jackscrews, allen head, captivated*		STYLE OF HARDWARE: 00 None 22 Two fixed jacknut assemblies	
POLARIZATION / WIRING: 00 None XX For wiring codes, see page MA-3 & MA-4		POLARIZATION / WIRING 0S Standard body polarization	

* = Captive hardware is factory installed and non-removable.



MSHT-252-037-325-220S
(METAL)

Board (Narrow Footprint) to Cable

.050"

9 thru 51 Contacts

Low Profile Board Mount
High Temperature

Low Profile Cable
High Temperature

MSHT

MQHT

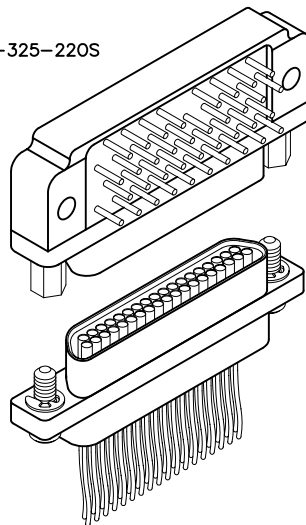

MQHT-222-037-261-41WS
(METAL)

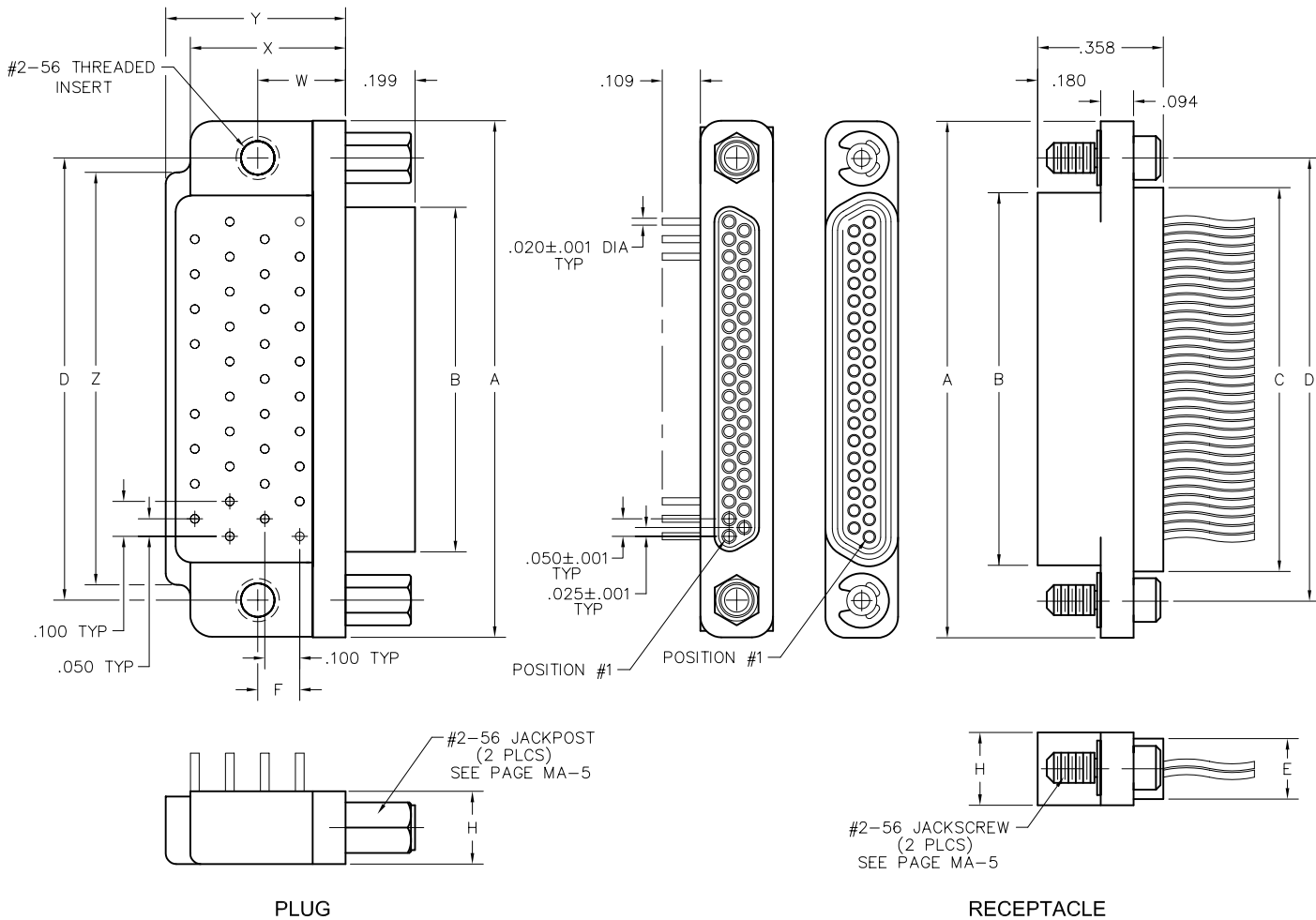

SIZE	CONTACT ROWS	DIMENSIONS											HARDWARE		
		A	B		C	D	E		F	H	W	X MAX		Y MAX	Z
			PLUG MAX	RCPT MAX			POTTING WELL MAX								
9	2	.778	.292	.378	.398	.565	.173	.120	.208	.250	.420	.420	.775	#2-56 UNC THD	
15		.928	.442	.528	.548	.715							.925		
21		1.078	.592	.678	.698	.865							1.075		
25		1.178	.692	.778	.798	.965							1.175		
31		1.328	.842	.928	.948	1.115							1.080		
37		1.478	.992	1.078	1.098	1.265							1.180		
51	3	1.428	.942	1.028	1.048	1.215	.220	.150	.250	.300	.425	.650	1.220		

PLUG: MSHT-252-037-323-220S

RECEPTACLE: MQHT-222-037-261-41WS

XXXX-XXX-XXX-XXX-XXXX

PLUG

RECEPTACLE

SERIES	
MSHT .050" Low Profile Metal PC Board Mount Connector (MSHT mates with MQHT receptacles)	MQHT .050" Low Profile Metal I/O Connector (MQHT mates with MQHT & MSHT plugs)
BODY	
2 2-Row (Sizes 9 thru 37)	2 2-Row (Sizes 9 thru 37)
3 3-Row (Size 51)	3 3-Row (Size 51)
BODY STYLE: 5 Plug, right angle, narrow footprint, w/ threaded inserts. High temperature.	BODY STYLE: 2 Receptacle, straight, with ears. High temperature.
BODY MATERIAL: 2 High temperature thermoplastic with electroless nickel shell	BODY MATERIAL: 2 High temperature thermoplastic with electroless nickel shell
SIZE	
XXX 009, 015, 021, 025, 031, 037, 051	XXX 009, 015, 021, 025, 031, 037, 051
CONTACTS	
TYPE CONTACTS/TERMINATIONS: 32 Pin, right angle, dip solder, .109" 33 Pin, right angle, dip solder, .140" 34 Pin, right angle, dip solder, .172"	TYPE CONTACTS/TERMINATIONS: 21 Socket, straight, solder cup 24 Socket, straight, .500" pigtails (.018 dia) 25 Socket, straight, 1.000" pigtails (.018 dia) 26 Socket, straight, crimped wire
PLATING OPTIONS: 3 50 μ" Au contacts: 10 μ" Au terminations	PLATING OPTIONS: 1 50 μ" Au contacts (crimp wire) 3 50 μ" Au contacts: 10 μ" Au terminations (solder cup, pigtail)
HARDWARE	
STYLE OF HARDWARE: 00 None 22 Two fixed jacknut assemblies	STYLE OF HARDWARE: 00 None 41 Two turning jackscrews, allen head, retaining ring 42 Two long turning jackscrews, allen head, retaining ring 43 Two turning jackscrews, slot head, retaining ring 44 Two long turning jackscrews, slot head, retaining ring 45 Two turning jackscrews, allen head, captivated*
POLARIZATION / WIRING: 0S Standard body polarization	POLARIZATION / WIRING: 00 None XX For wiring codes, see page MA-3 & MA-4

* = Captive hardware is factory installed and non-removable.



Recommended PC Board Layout

Right Angle, Narrow Footprint
Standard Polarization

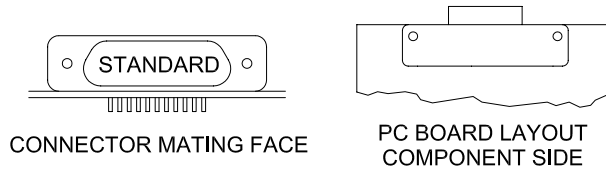

CONNECTOR MATING FACE (RECEPTACLE)

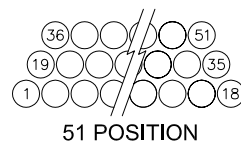
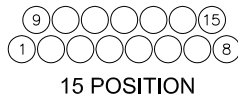

RECEPTACLE PC BOARD LAYOUT COMPONENT SIDE

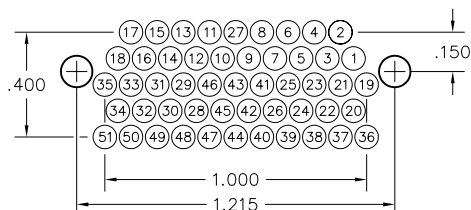
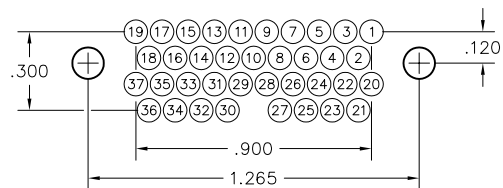
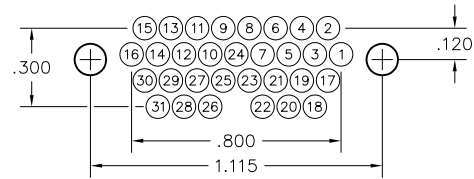
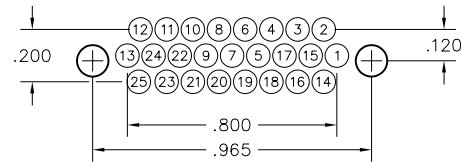
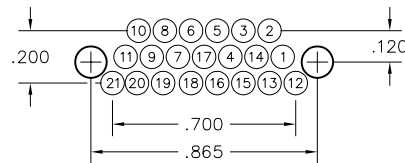
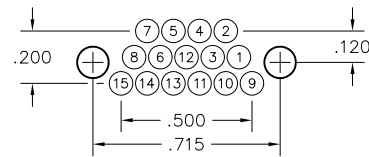
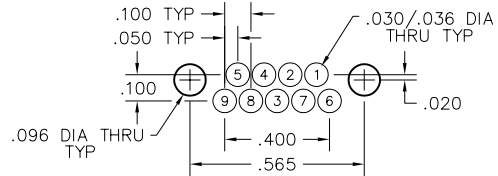

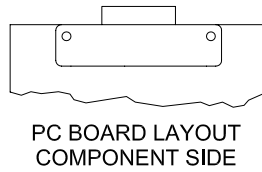
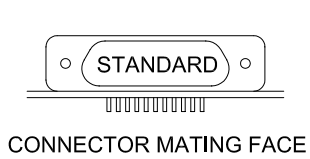

AirBorn
Recommended PC Board Layout
 Right Angle, Narrow Footprint
 Standard Polarization

CONNECTOR MATING FACE (PLUG)

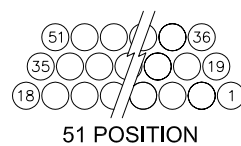
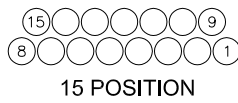
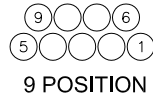

PLUG
 PC BOARD LAYOUT COMPONENT SIDE

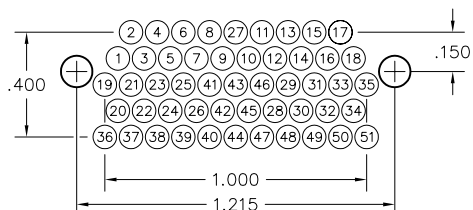
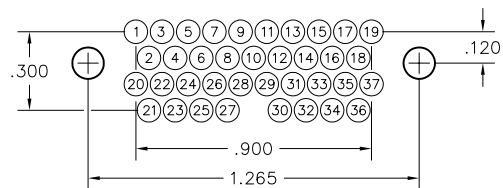
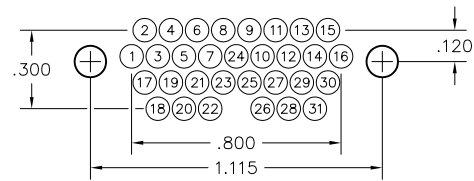
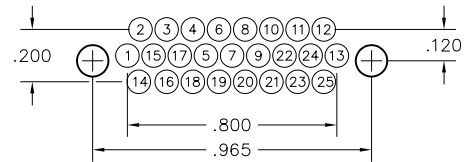
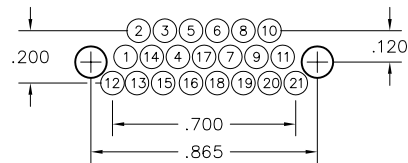
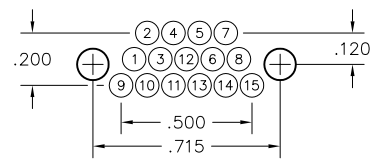
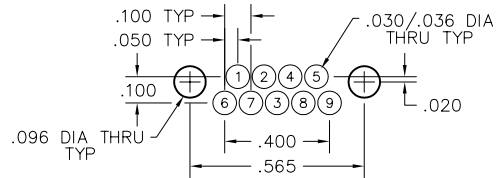



Cable to Board

.050"

9 thru 51 Contacts

Low Profile Cable

High Temperature

MTHT

Low Profile Board Mount

High Temperature

MTHT

MTHT-212-021-161-43WQ
(METAL)

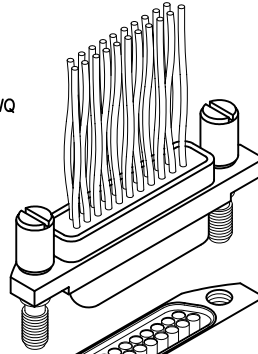

MTHT-2E2-021-433-000S
(METAL)

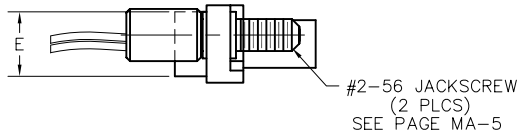
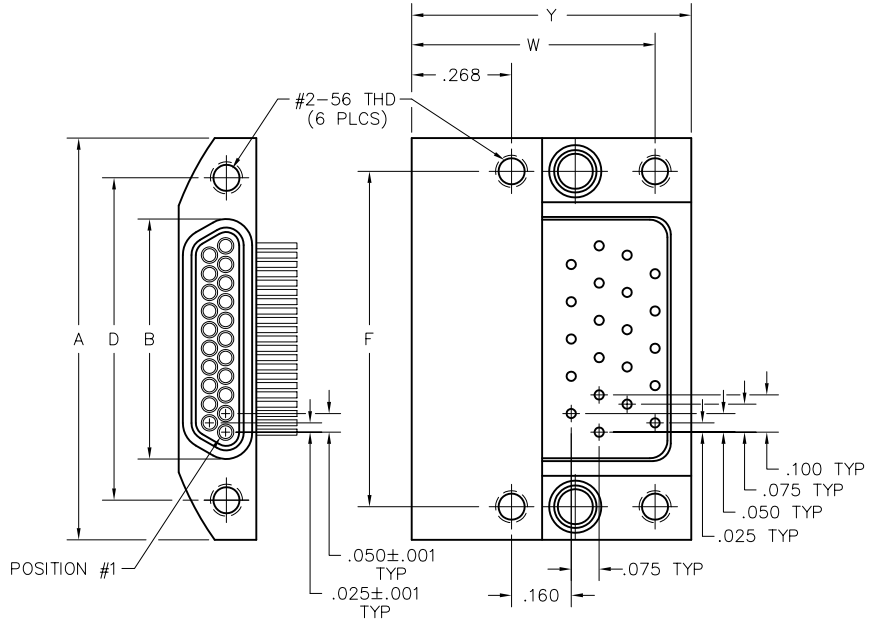
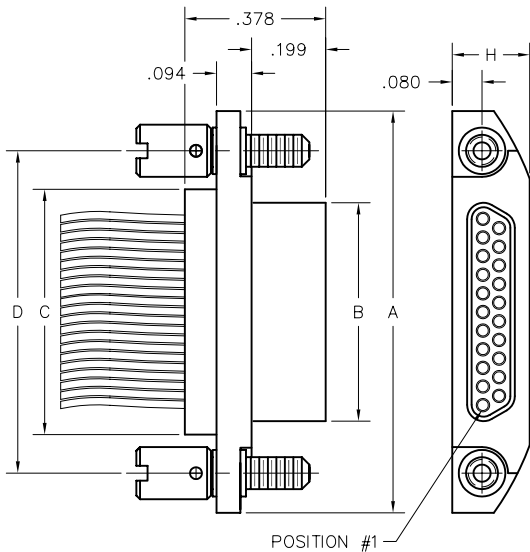
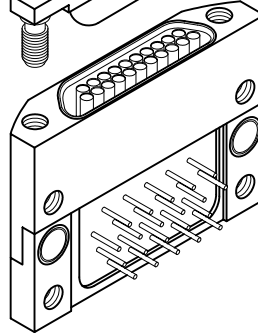

PLUG

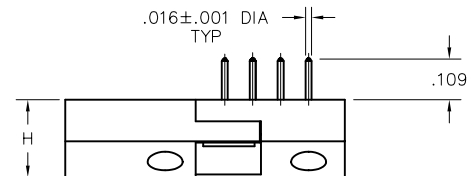

RECEPTACLE

SIZE	CONTACT ROWS	DIMENSIONS										
		A	B		C	D	E	F	H	HARDWARE	W	Y
			PLUG MAX	RCPT MAX								
9	2	.778	.292	.378	.398	.565	.173	.600	.208	#2-56 UNC THD (.092 DIA THRU)	.608	.690
15		.928	.442	.528	.548	.715		.750				
21		1.078	.592	.678	.698	.865		.900				
25		1.178	.692	.778	.798	.965		1.000				
31		1.328	.842	.928	.948	1.115		1.150				
37	1.478	.992	1.078	1.098	1.265	1.300	.250			.728	.825	
51	3	1.428	.942	1.028	1.048	1.215						.220

PLUG: MHTH- 212 - 021 - 161 - 43WQ
RECEPTACLE: MHTH- 2E2 - 021 - 433 - 000S
 XXXX - XXX - XXX - XXX - XXXX

PLUG		RECEPTACLE	
SERIES			
MHTH .050" Low Profile Metal I/O Connector (MHTH mates with MHTH receptacles)		MHTH .050" Low Profile Metal PC Board Mount Connector (MHTH mates with MHTH plugs)	
BODY			
2	2-Row (Sizes 9 thru 37)	2	2-Row (Sizes 9 thru 37)
3	3-Row (Size 51)	3	3-Row (Size 51)
BODY STYLE:		BODY STYLE:	
1	Plug, straight, with ears. Low profile, radius. High temperature.	E	Receptacle, right angle, with four mounting holes. Low profile, radius. High temperature.
BODY MATERIAL:		BODY MATERIAL:	
2	High temperature thermoplastic with electroless nickel shell	2	High temperature thermoplastic with electroless nickel shell
SIZE			
XXX 009, 015, 021, 025, 031, 037, 051		XXX 009, 015, 021, 025, 031, 037, 051	
CONTACTS			
TYPE CONTACTS/TERMINATIONS:		TYPE CONTACTS/TERMINATIONS:	
11	Pin, straight, solder cup	43	Socket, right angle, gold plated, .109" x .016" dia
14	Pin, straight, .500" pigtailed (.018 dia)	44	Socket, right angle, gold plated, .140" x .016" dia
15	Pin, straight, 1.000" pigtailed (.018 dia)	45	Socket, right angle, gold plated, .172" x .016" dia
16	Pin, straight, crimped wire		
PLATING OPTIONS:		PLATING OPTIONS:	
1	50 μ" Au contacts (crimp wire)	3	50 μ" Au contacts: 10 μ" Au terminations
3	50 μ" Au contacts: 10 μ" Au terminations (solder cup, pigtail)		
HARDWARE			
STYLE OF HARDWARE:		STYLE OF HARDWARE:	
00	None	00	Integrated jacknuts
41	Two turning jackscrews, allen head		
43	Two turning jackscrews, slot head		
POLARIZATION / WIRING:		POLARIZATION / WIRING:	
00	None	0S	Standard body polarization
XX	For wiring codes, see page MA-3 & MA-4		



Recommended PC Board Layout

Low Profile, Right Angle
Standard Polarization



CONNECTOR MATING FACE



PC BOARD LAYOUT
COMPONENT SIDE

CONNECTOR
MATING FACE
(RECEPTACLE)

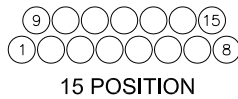
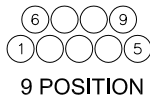

RECEPTACLE
PC BOARD LAYOUT
COMPONENT SIDE

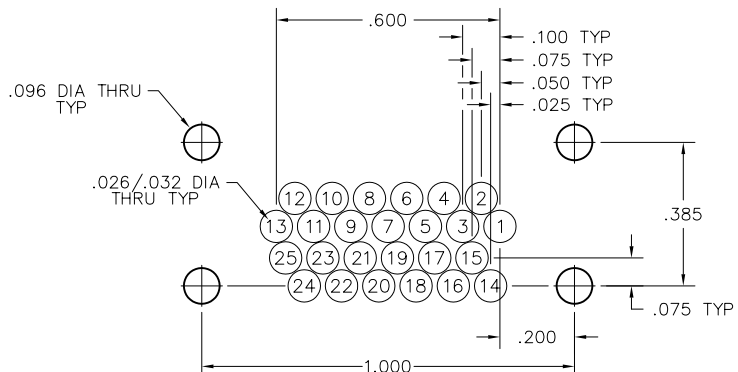
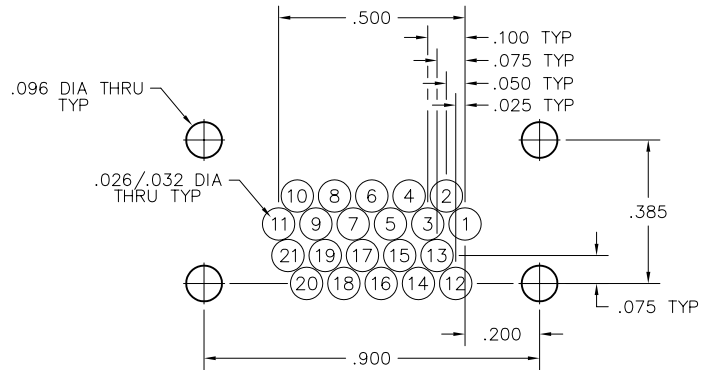
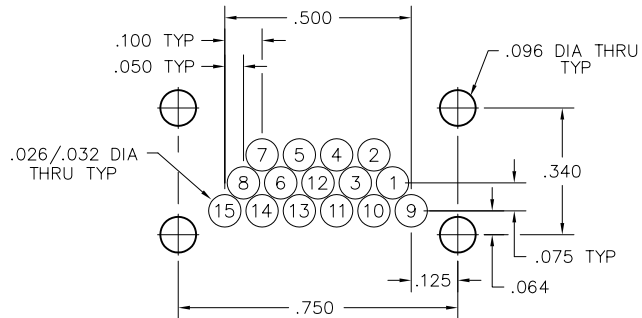
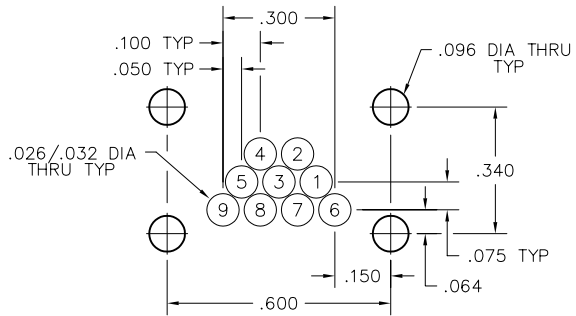



CONNECTOR MATING FACE

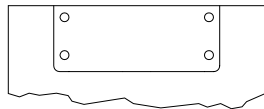

PC BOARD LAYOUT
COMPONENT SIDE



Recommended PC Board Layout

Low Profile, Right Angle
Standard Polarization

CONNECTOR MATING FACE
(RECEPTACLE)



31 POSITION



37 POSITION



51 POSITION

RECEPTACLE
PC BOARD LAYOUT
COMPONENT SIDE

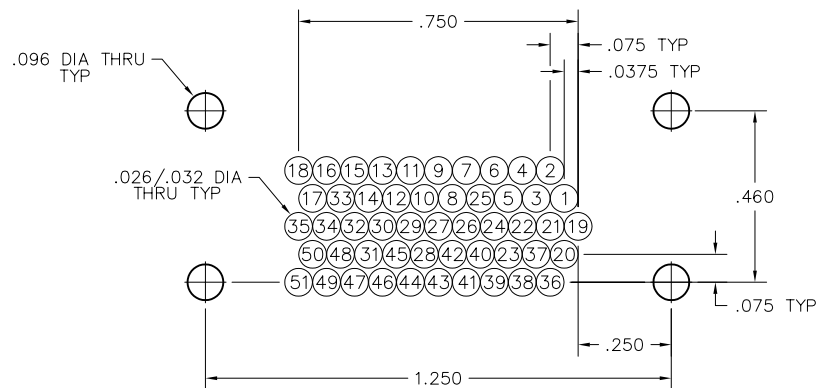
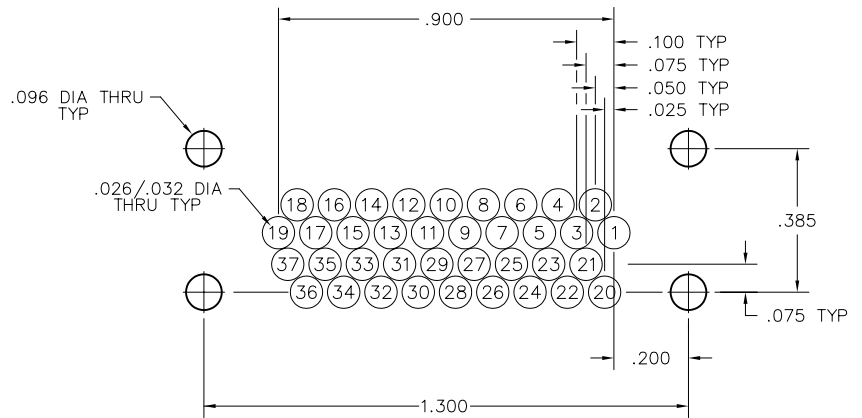
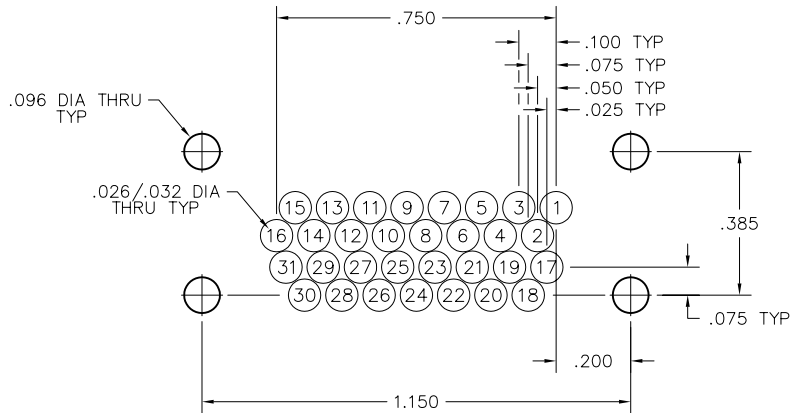

"M" SERIES ACCESSORIES

Contents

"M" Series

Hardware, Contacts and Accessories

Wire Codes, Contacts and Hardware

MA-2	Contacts, contact positions and connector polarization
MA-3, MA-4	Wire codes (24 awg, 26 awg, 28 awg and twisted pairs)
MA-5	Hardware - MM, MN, MP, MQ, MMHT and MQHT
MA-6	Keying hardware
MA-7	Hardware - MM, MQ, EMI and Rear Panel Mount (MM and MK)
MA-8	Hardware - Miscellaneous

Accessories

MA-11	Connector savers, rugged (metal - MQ and plastic - MN)
MA-13	Connector savers, low profile (metal - MQ and plastic - MN)
MA-15	EMI/RFI backshells, straight exit, rugged (metal - MM)
MA-17	EMI/RFI backshells, 45° exit, rugged (metal - MM)
MA-19	EMI/RFI backshells, 90° exit, rugged (metal - MM)
MA-21	EMI/RFI backshells, straight exit, low profile (metal - MQ)
MA-23	Dust covers, rugged (metal - MD)
MA-25	ESD dust covers, rugged and low profile (plastic - MD)
MA-26	O-rings and gaskets
MA-27	Rear Panel Mount Hardware
MA-28	Panel cut-outs, MM connectors with grounding fingers

Contacts

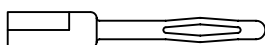

PIN CONTACT
WITH CRIMP BARREL

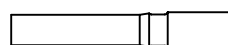

SOCKET CONTACT
WITH CRIMP BARREL

Contact Positions

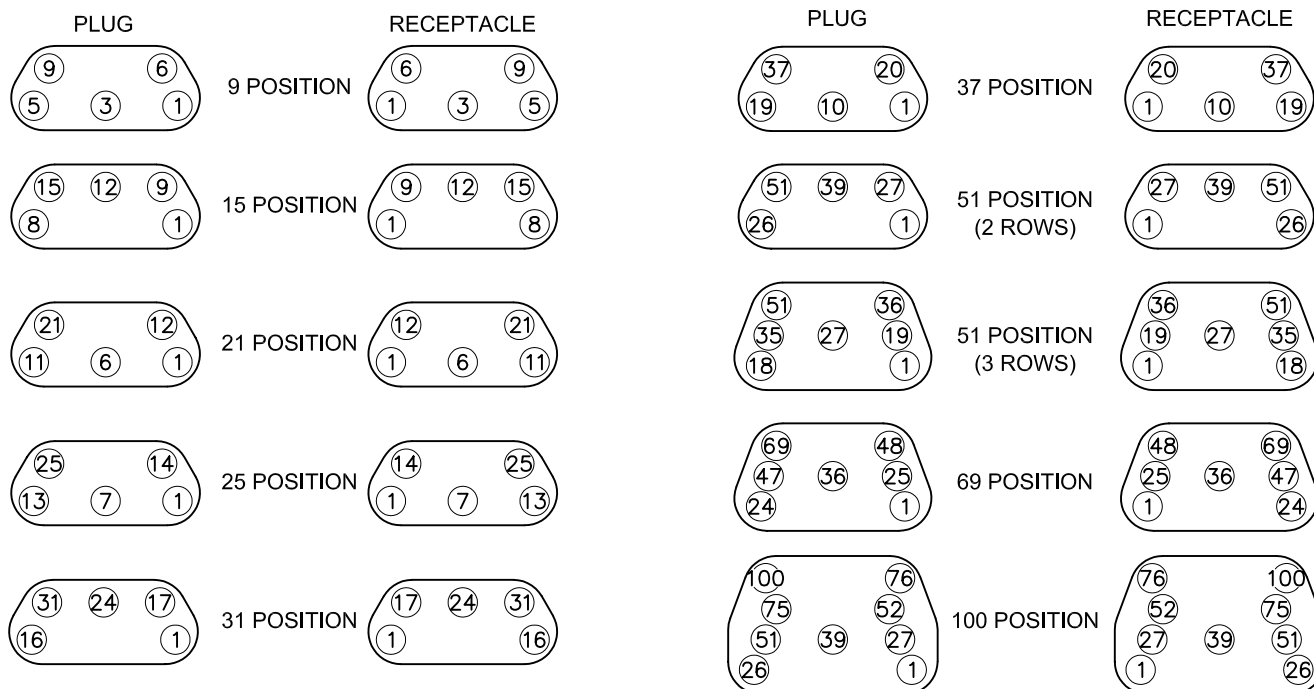

Hybrid Connectors

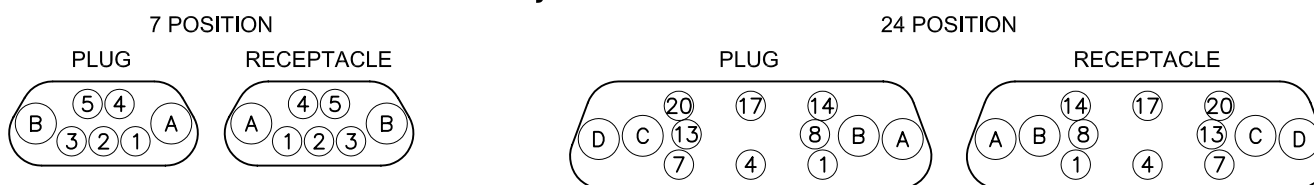

Note: Numbers indicate corner and centermost contacts. Views shown are mating face.

Connector Polarization



Note: Polarization option applies to PC board mounted, right angle connectors.
(Series MK, ML, MR & MS)

Only standard polarization option applies to PC board mounted, right angle,
high temperature connectors. (Series MKHT, MSHT & MTHT)



Wire Codes

NEMA HP3-EXBEB (Formerly M16878/4-24 TFE 7 strand)

	6"	12"	18"	24"	30"	36"	42"	48"	54"	60"	66"	72"	84"	96"	108"	120"
MIL-STD-681*	WA	WB	WC	UD	UE	WD	UG	UH	UJ	UK	UL	UM	UN	UP	UQ	UR
WHITE	WE	WF	WG	VD	VE	WH	VG	VH	VJ	VK	VL	VM	VN	VP	VQ	VR
YELLOW	WJ	WK	WL			WM										

NEMA HP3-EXBDB (Formerly M16878/4-26 TFE 7 strand)

	6"	12"	18"	24"	30"	36"	42"	48"	54"	60"	66"	72"	84"	96"	108"	120"
MIL-STD-681*	WN	WP	WQ	YD	YE	WR	YG	YH	YJ	YK	YL	YM	YN	YP	YQ	YR
WHITE	WS	WT	WU	ZD	ZE	WV	ZG	ZH	ZJ	ZK	ZL	ZM	ZN	ZP	ZQ	ZR
YELLOW	WW	WX	WY			WZ										

NEMA HP3-EXBCB (Formerly M16878/4-28 TFE 7 strand)

	6"	12"	18"	24"	30"	36"	42"	48"	54"	60"	66"	72"	84"	96"	108"	120"
MIL-STD-681*	XA	XB	XC	1D	1E	XD	1G	1H	1J	1K	1L	1M	1N	1P	1Q	1R
WHITE	XE	XF	XG	2D	2E	XH	2G	2H	2J	2K	2L	2M	2N	2P	2Q	2R
YELLOW	XJ	XK	XL			XM										

TWISTED PAIR per NEMA WC27500-XXRC2U00 (SAE AS22759/11)

	6"	12"	18"	24"	30"	36"	42"	48"	54"	60"	66"	72"	84"	96"	108"	120"
24 AWG	AA	AB	AC	AD	AE	AF	AG	AH	AJ	AK	AL	AM	AN	AP	AQ	AR
26 AWG	BA	BB	BC	BD	BE	BF	BG	BH	BJ	BK	BL	BM	BN	BP	BQ	BR

TWISTED PAIR per NEMA WC27500-XXSC2U00 (SAE AS22759/33)*** ☒

	6"	12"	18"	24"	30"	36"	42"	48"	54"	60"	66"	72"	84"	96"	108"	120"
24 AWG	JA	JB	JC	JD	JE	JF	JG	JH	JJ	JK	JL	JM	JN	JP	JQ	JR
26 AWG	KA	KB	KC	KD	KE	KF	KG	KH	KJ	KK	KL	KM	KN	KP	KQ	KR

For twisted pair wire connect charts, see page MA-9
 Twisted pair wire not available on MA, MC or Hybrid connectors

* = Connectors with more than 100 contacts will repeat color code after 100 colors.
 *** = Per M83513, corrosion has been experienced on connectors that are pre-wired with 22759/33 and stored in sealed environments.
 Caution should be exercised when using this wire.
 ☒ = Option not RoHS compliant

Wire Codes

SAE AS22759/11-24

	6"	12"	18"	24"	30"	36"	42"	48"	54"	60"	66"	72"	84"	96"	108"	120"
M83513**	5A	5B	5C	5D	5E	5F	5G	5H	5J	5K	5L	5M	5N	5P	5Q	5R
MIL-STD-681*	CA	CB	CC	CD	CE	CF	CG	CH	CJ	CK	CL	CM	CN	CP	CQ	CR
WHITE	DA	DB	DC	DD	DE	DF	DG	DH	DJ	DK	DL	DM	DN	DP	DQ	DR

SAE AS22759/11-26

	6"	12"	18"	24"	30"	36"	42"	48"	54"	60"	66"	72"	84"	96"	108"	120"
M83513**	6A	6B	V1	6D	6E	V2	6G	6H	6J	6K	6L	Y6	6N	6P	6Q	6R
MIL-STD-681*	X3	X4	W3	ED	EE	W4	EG	EH	EJ	EK	EL	EM	EN	EP	EQ	ER
WHITE	X1	X2	W1	FD	FE	W2	FG	FH	FJ	FK	FL	Y5	FN	FP	FQ	FR

SAE AS22759/33-24*** ☒

	6"	12"	18"	24"	30"	36"	42"	48"	54"	60"	66"	72"	84"	96"	108"	120"
M83513**	LA	LB	LC	LD	LE	LF	LG	LH	LJ	LK	LL	LM	LN	LP	LQ	LR
WHITE	MA	MB	MC	MD	ME	MF	MG	MH	MJ	MK	ML	MM	MN	MP	MQ	MR

SAE AS22759/33-26*** ☒

	6"	12"	18"	24"	30"	36"	42"	48"	54"	60"	66"	72"	84"	96"	108"	120"
M83513**	NA	NB	Y3	ND	NE	Y4	NG	NH	NJ	NK	NL	Y8	NN	NP	NQ	NR
WHITE	PA	PB	Y1	PD	PE	Y2	PG	PH	PJ	PK	PL	Y7	PN	PP	PQ	PR

* = Connectors with more than 100 contacts will repeat color code after 100 colors.

** = Wire colors per M83513 are ten solid colors repeating.

*** = Per M83513, corrosion has been experienced on connectors that are pre-wired with 22759/33 and stored in sealed environments.

Caution should be exercised when using this wire.

☒ = Option not RoHS compliant

Hardware

MM - MN - MQ - MP - MMHT - MQHT Jacking Hardware

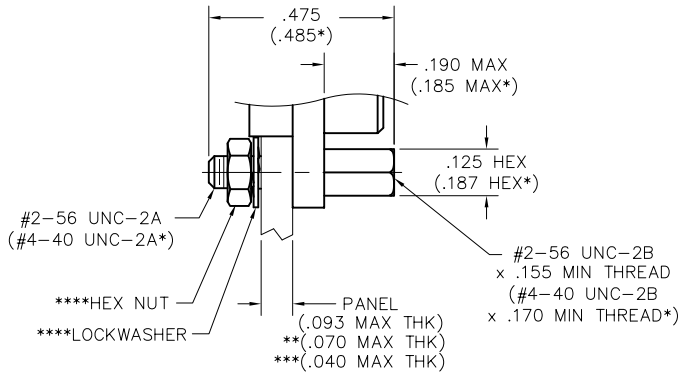

JACKPOST ASSEMBLY

#2-56 JACKPOST	00-000-000-000-2200
#4-40 JACKPOST	00-000-000-000-6200

FOR RECEPTACLES WITH GROUNDING FINGERS

#2-56 JACKPOST	00-000-000-000-2200-0G7
#4-40 JACKPOST	00-000-000-000-6200-0G7

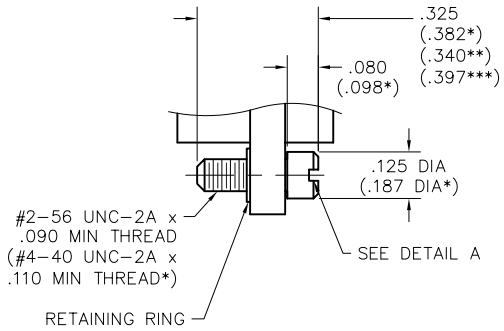

SHORT TURNING

JACKSCREW ASSEMBLY

#2-56 JACKSCREW, ALLEN HEAD	00-000-000-000-4100
#2-56 JACKSCREW, SLOT HEAD	00-000-000-000-4300
#4-40 JACKSCREW, ALLEN HEAD	00-000-000-000-8100
#4-40 JACKSCREW, SLOT HEAD	00-000-000-000-8300

FOR RECEPTACLES WITH GROUNDING FINGERS

#2-56 JACKSCREW, ALLEN HEAD	00-000-000-000-4100-0G7
#2-56 JACKSCREW, SLOT HEAD	00-000-000-000-4300-0G7
#4-40 JACKSCREW, ALLEN HEAD	00-000-000-000-8100-0G7
#4-40 JACKSCREW, SLOT HEAD	00-000-000-000-8300-0G7

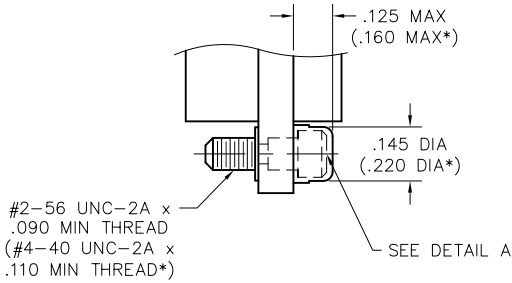

SHORT CAPTIVE JACKSCREW ASSEMBLY

JACKSCREW, ALLEN HEAD
FACTORY INSTALLED ONLY

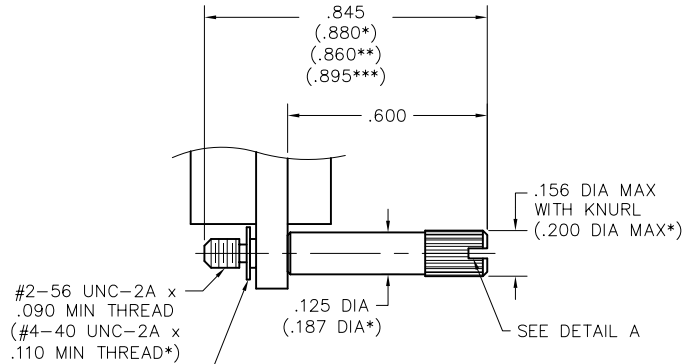

LONG TURNING

JACKSCREW ASSEMBLY

#2-56 JACKSCREW, ALLEN HEAD	00-000-000-000-4200
#2-56 JACKSCREW, SLOT HEAD	00-000-000-000-4400
#4-40 JACKSCREW, ALLEN HEAD	00-000-000-000-8200
#4-40 JACKSCREW, SLOT HEAD	00-000-000-000-8400

FOR RECEPTACLES WITH GROUNDING FINGERS

#2-56 JACKSCREW, ALLEN HEAD	00-000-000-000-4200-0G7
#2-56 JACKSCREW, SLOT HEAD	00-000-000-000-4400-0G7
#4-40 JACKSCREW, ALLEN HEAD	00-000-000-000-8200-0G7
#4-40 JACKSCREW, SLOT HEAD	00-000-000-000-8400-0G7

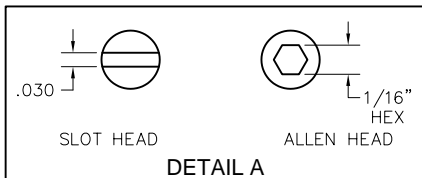

- * = Dimensions for 100 position connectors
- ** = Applies to #2-56 hardware for receptacles with grounding fingers
- *** = Applies to #4-40 hardware for receptacles with grounding fingers
- **** = Hardware for Receptacles with Grounding Fingers will come with a flat washers, lockwashers, and spanner nuts

Polarized Keying Hardware



Select the appropriate two digit number above and include as the last two digits of the hardware code in the part number. (Keying hardware is factory installed and non-removable).

Example:

MM-213-025-161-99WA-KS11

MK-263-025-435-990S-KP11

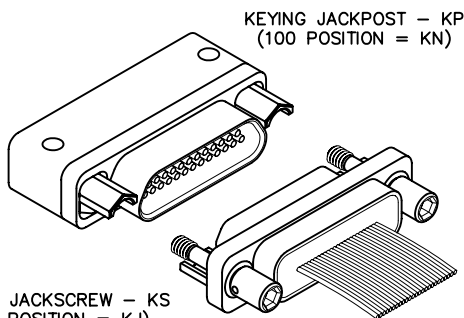

KEYING JACKSCREW - KS
(100 POSITION = KJ)

KEYING JACKPOST - KP
(100 POSITION = KN)

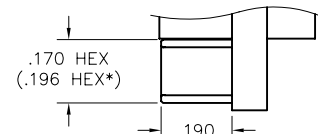
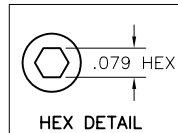

KEYING JACKPOST

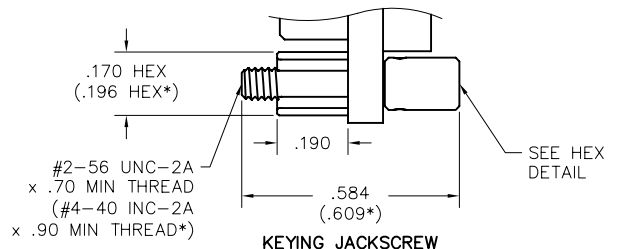

KEYING JACKSCREW

* = Dimensions for 100 position connectors

Hardware

MM - MQ I/O with EMI/RFI Backshell

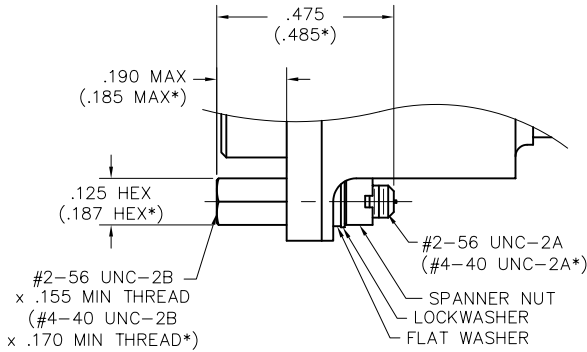

JACKPOST ASSEMBLY

- #2-56 JACKPOST 00-000-000-000-2200-01G
- #4-40 JACKPOST 00-000-000-000-6200-04A

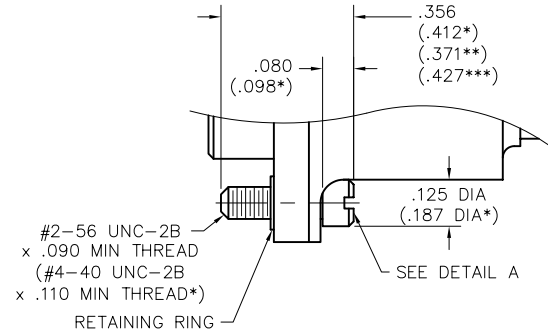

SHORT TURNING

JACKSCREW ASSEMBLY

- #2-56 JACKSCREW, ALLEN HEAD 00-000-000-000-4100-01G
- #2-56 JACKSCREW, SLOT HEAD 00-000-000-000-4300-01G
- #4-40 JACKSCREW, ALLEN HEAD 00-000-000-000-8100-04A
- #4-40 JACKSCREW, SLOT HEAD 00-000-000-000-8300-04A

FOR RECEPTACLES WITH GROUNDING FINGERS

- #2-56 JACKSCREW, ALLEN HEAD 00-000-000-000-4100-0FZ
- #2-56 JACKSCREW, SLOT HEAD 00-000-000-000-4300-0FZ
- #4-40 JACKSCREW, ALLEN HEAD 00-000-000-000-8100-0FZ
- #4-40 JACKSCREW, SLOT HEAD 00-000-000-000-8300-0FZ

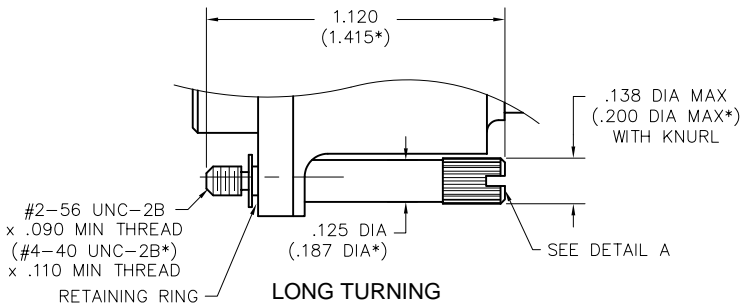

**LONG TURNING
JACKSCREW ASSEMBLY**

- #2-56 JACKSCREW, SLOT HEAD 00-000-000-000-4400-01G
- #4-40 JACKSCREW, SLOT HEAD 00-000-000-000-8400-04A

FOR RECEPTACLES WITH GROUNDING FINGERS

- #2-56 JACKSCREW, SLOT HEAD 00-000-000-000-4400-0FZ
- #4-40 JACKSCREW, SLOT HEAD 00-000-000-000-8400-0FZ

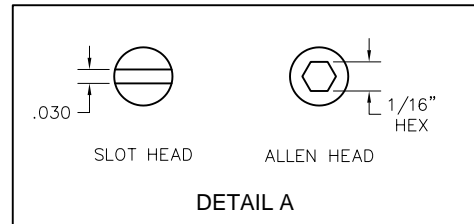

* = Dimensions for #4-40 hardware (100 position connectors)
 ** = Applies to #2-56 hardware for receptacles with grounding fingers
 *** = Applies to #4-40 hardware for receptacles with grounding fingers

MM - MK Rear Panel Mount Jackposts for Body Styles "A", "C", "E", "H", "K", and "L"

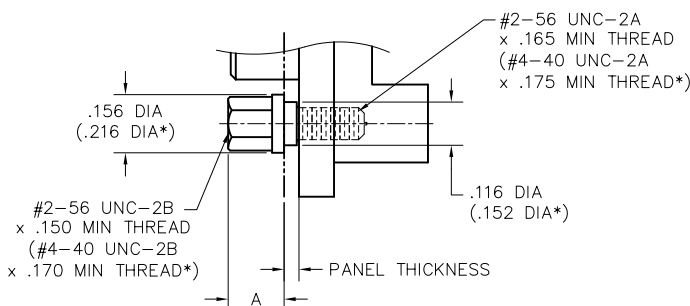

PANEL THK	THREAD SIZE	PART NUMBER	A MAX
.040	#2-56	MM-000-000-000-2400-0D1	.150
.060		MM-000-000-000-2600-0D3	.130
.070		MM-000-000-000-2800-0D5	.120
.080		MM-000-000-000-2900-0D7	.110
.040	#4-40	MM-000-000-000-6400-0D2	.150
.060		MM-000-000-000-6600-0D4	.130
.070		MM-000-000-000-6800-0D6	.120
.080		MM-000-000-000-6900-0D8	.110

* = Dimensions for 100 position connectors

Hardware

MK Vertical SMT

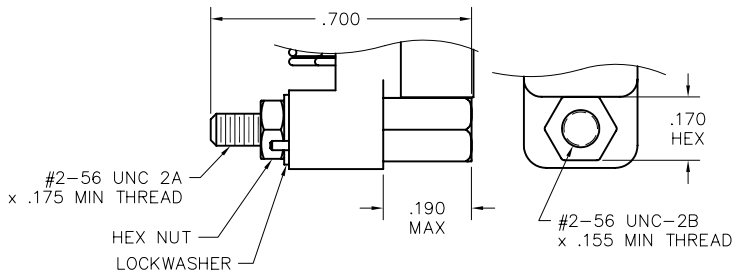

JACKPOST ASSEMBLY
FACTORY INSTALLED ONLY

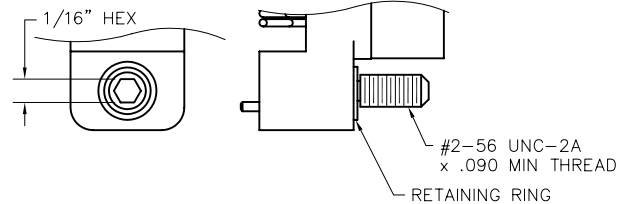

TURNING JACKSCREW ASSEMBLY
FACTORY INSTALLED ONLY

MK - MS MKHT - MSHT

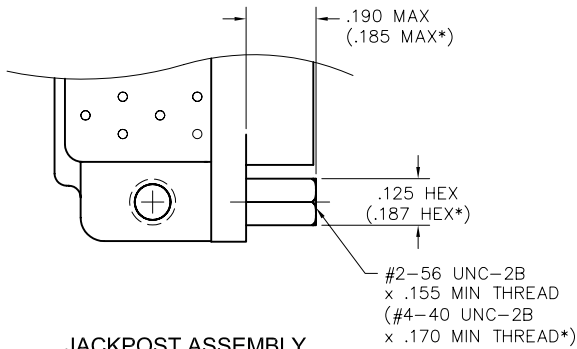

JACKPOST ASSEMBLY
CONSULT FACTORY

MTHT

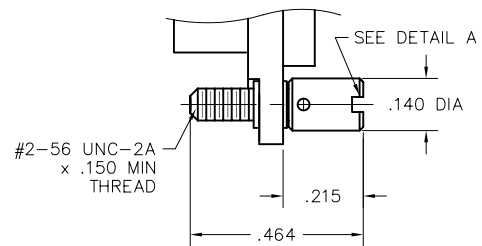

JACKSCREW ASSEMBLY
FACTORY INSTALLED ONLY

* = Dimensions for 100 position connectors

MA

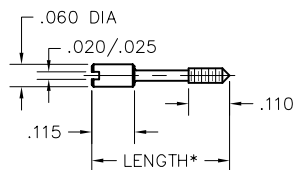

**1 MM LOCKSCREW
FOR MA STRIP CONNECTORS**
* .370 LONG CDG10492
* .465 LONG CDG10493

Mounting Bracket

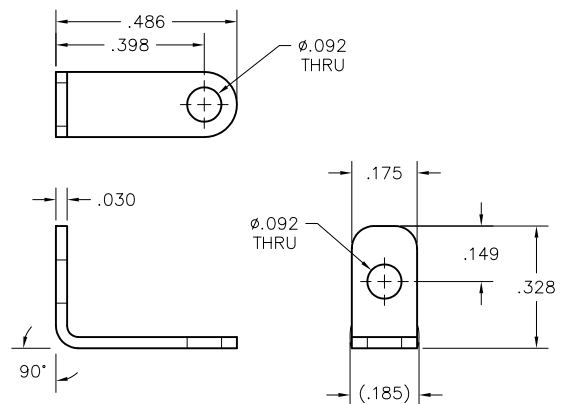

CDG12633 - 2 EACH



Twisted Pair Wire Connect Charts

100 POSITION

9 POSITION

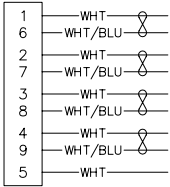

15 POSITION

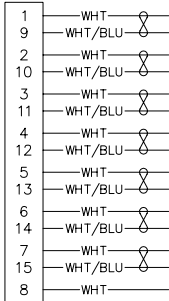

51 POSITION 2 rows

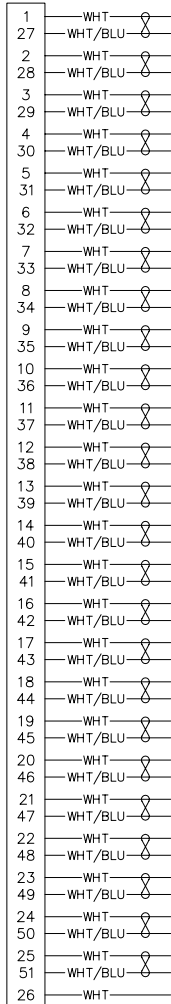

51 POSITION 3 rows

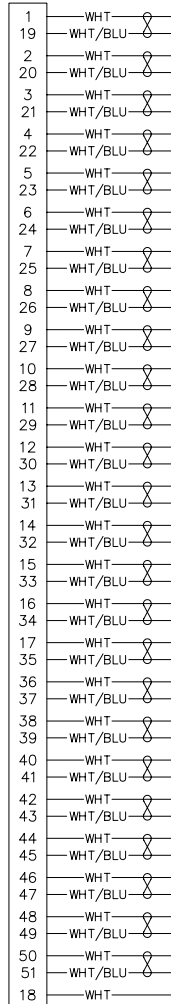

69 POSITION

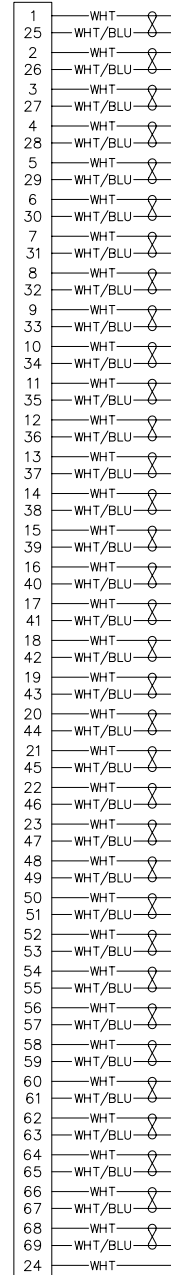

21 POSITION

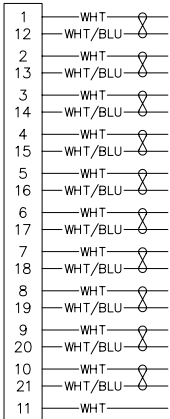

25 POSITION

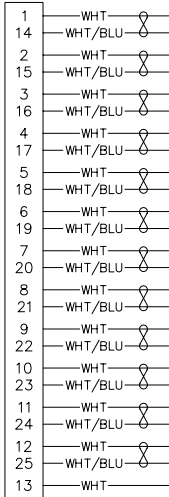

37 POSITION

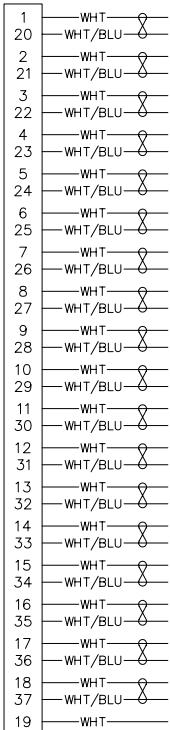

31 POSITION

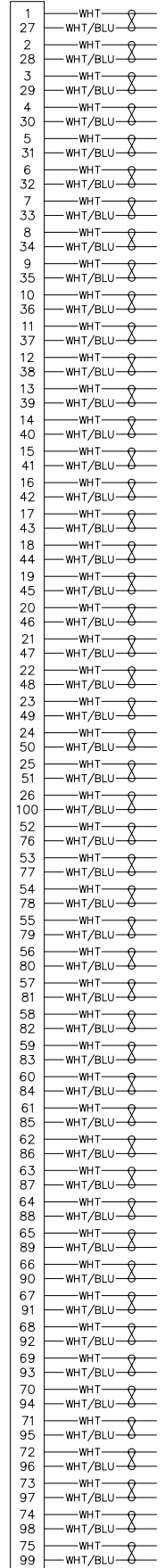
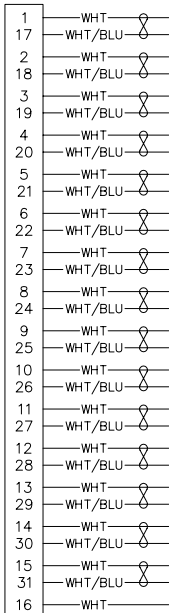

Panel Mounting Dimensions

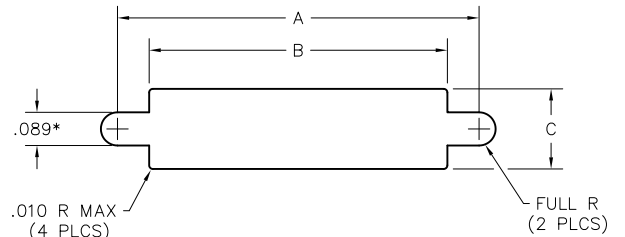
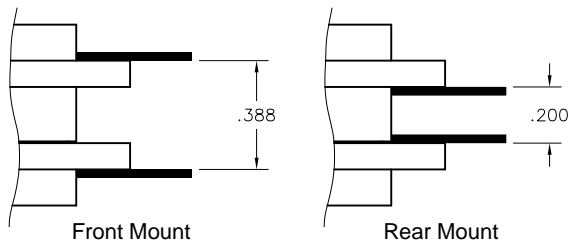

* = .118 FOR 100 POSITION CONNECTOR

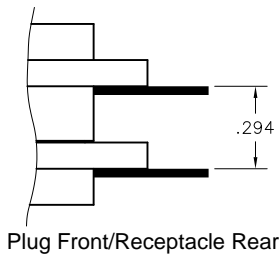

MOUNTING DIMENSIONS

		DIMENSIONS			
CONTACT ROWS	SIZE	A +.004 -.000	B +.005 -.000	C +.004 -.000	
				MP, MQ, MR, MS MQHT, MSHT	MK, ML, MM, MN MKHT, MMHT
2	9	.570	.400	.215	.273
	15	.720	.550		
	21	.870	.700		
	25	.970	.800		
	31	1.120	.950		
	37	1.270	1.100		
3	51	1.220	1.034	.256	.311
	69	1.520	1.334		
4	100	1.805	1.503	—	.383

Panel Mounting Dimensions for Rear Panel Mount Connectors

RUGGED METAL
MM, MN, MK, ML
SIZES: 9 - 69

DIMENSIONS			
SIZE	A +.004 -.000	B +.005 -.000	C ±.005
9	.401	.252	.565
15	.551		.715
21	.701		.865
25	.801		.965
31	.951		1.115
37	1.101	.295	1.265
51	1.051		1.215
69	1.351		1.515

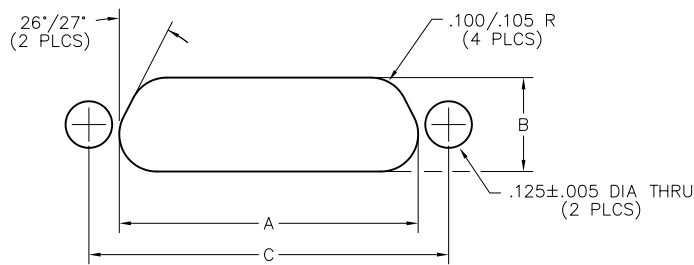

LOW PROFILE
MQ, MP, MS, MR
SIZES: 9 - 51

DIMENSIONS			
SIZE	A +.004 -.000	B +.005 -.000	C ±.005
9	.379	.219	.565
15	.529		.715
21	.679		.865
25	.779		.965
31	.929		1.115
37	1.079	.261	1.265
51	1.029		1.215

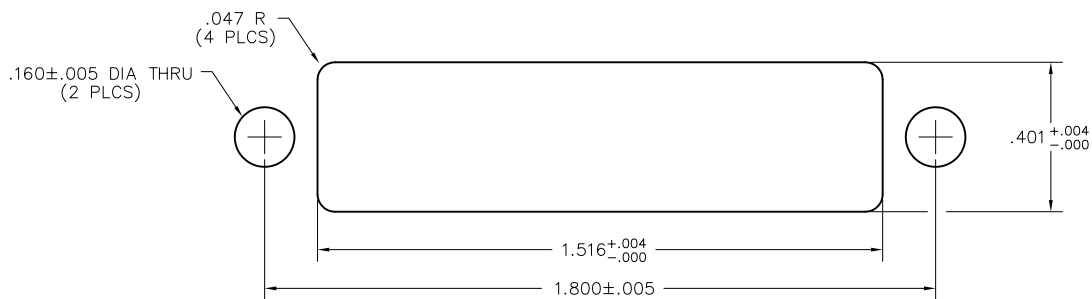

RUGGED METAL
MM, MN, MK, ML
SIZE 100



Connector Saver

.050"

9 thru 100 Contacts

Rugged Metal

MM

Rugged Plastic

MN

MM-212-031-143-2200-93A
(METAL)

MN-211-031-143-2200-93A
(PLASTIC)

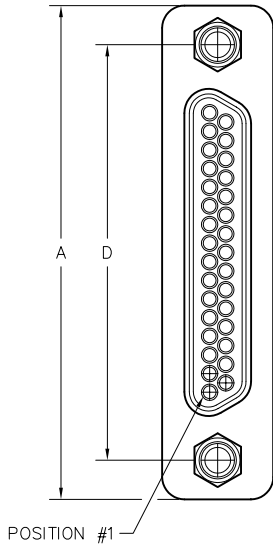
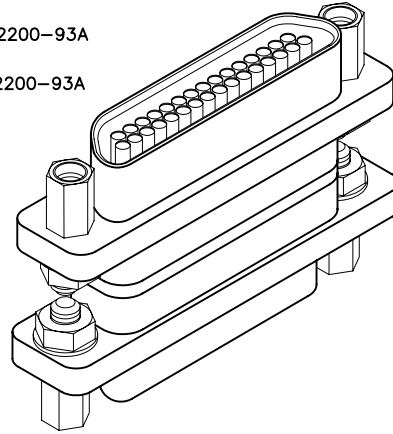

PLUG

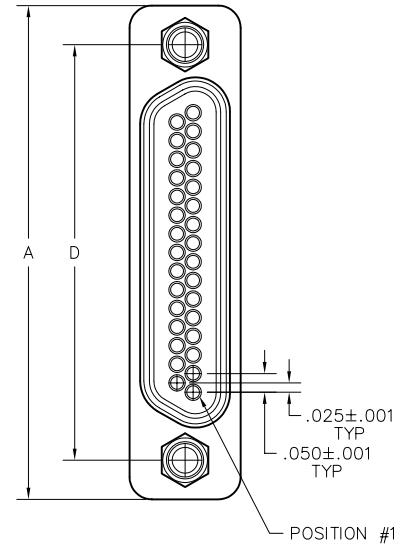
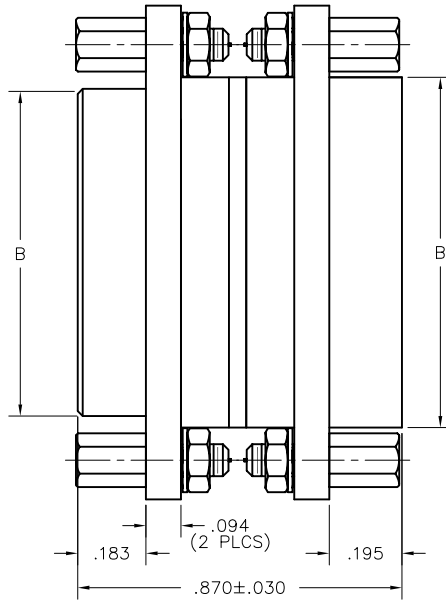

RECEPTACLE

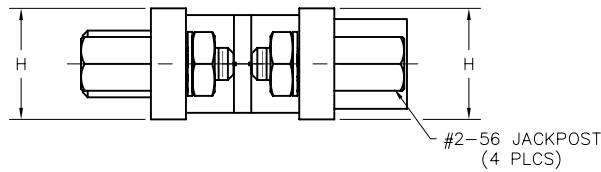

DIMENSIONS							
SIZE	CONTACT ROWS	A	B		D	H	HARDWARE
			PLUG MAX	RCPT MAX			
9	2	.775	.334	.400	.565	.298	#2-56 UNC THD (.092 DIA THRU)
15		.925	.484	.550	.715		
21		1.075	.634	.700	.865		
25		1.175	.734	.800	.965		
31		1.325	.884	.950	1.115		
37		1.475	1.034	1.100	1.265		
51**	3	1.825	1.384	1.450	1.615	.341	#4-40 UNC THD (.147 DIA THRU)
51		1.425	.984	1.050	1.215		
69***		1.725	1.284	1.350	1.515		
100	4	2.160	1.384	1.508	1.800	.384	#4-40 UNC THD (.147 DIA THRU)

** = 2 ROW, 51 POSITION CONNECTORS ARE AVAILABLE IN METAL ONLY (NON MIL-SPEC INTERFACE)
 *** = 69 POSITION CONNECTORS ARE AVAILABLE IN METAL ONLY.

PLUG/RECEPTACLE: MM- 212 - 031 - 143 - 2200 - 93A
 MN- 211 - 031 - 143 - 2200 - 93A
 XX-XXX-XXX-XXX-XXXX-XXX

SERIES

MM .050" Rugged Metal
 MN .050" Rugged Plastic

BODY

- 2 2-Row (Sizes 9 thru 51**)
- 3 3-Row (Size 51 & 69***)
- 4 4-Row (Size 100)

BODY STYLE:

- 1 Plug/Receptacle, straight with mounting ears, receptacle includes interfacial sealing gasket

BODY MATERIAL:

- 1 Polyphenylene Sulfide (MN only)
- 2 Polyphenylene Sulfide with electroless nickel shell
- 3 Polyphenylene Sulfide with electrodeposited cadmium shell ☒
- 4 Polyphenylene Sulfide with hard anodized black shell

SIZE

XXX 009, 015, 021, 025, 031, 037, 051**, 069***, 100

CONTACTS

TYPE CONTACTS/TERMINATIONS:

- 14 Pin/Socket, straight

PLATING OPTIONS:

- 3 50 μ" Au contacts: 10 μ" Au terminations

HARDWARE

STYLE OF HARDWARE:

- 00 None
- 22 Two fixed jacknut assemblies (62*)
- JA Turning jackpost with retaining ring, uninstalled (PA*)
- JP Turning jackpost, internal thread on plug side (PP*)
- JS Turning jackpost, internal thread on receptacle side (PS*)

POLARIZATION / WIRING:

- 00 None

SPECIAL DESIGNATORS

93A Connector saver designator

* = Use number in parenthesis when ordering size 100.
 ** = 2 row, 51 position connectors are available in metal only (non mil-spec interface)
 *** = 69 position connectors are available in metal only.

☒ = Option not RoHS compliant

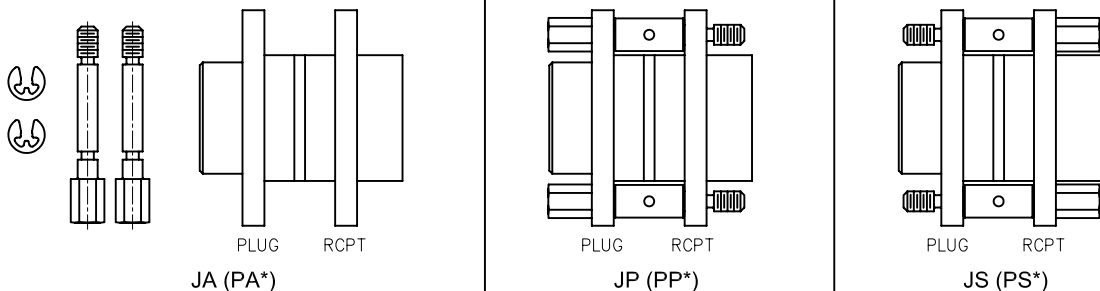



Connector Saver

.050"

9 thru 51 Contacts

Low Profile Metal

MQ

Low Profile Plastic

MP

MQ-212-031-143-2200-93A
(METAL)

MP-211-031-143-2200-93A
(PLASTIC)

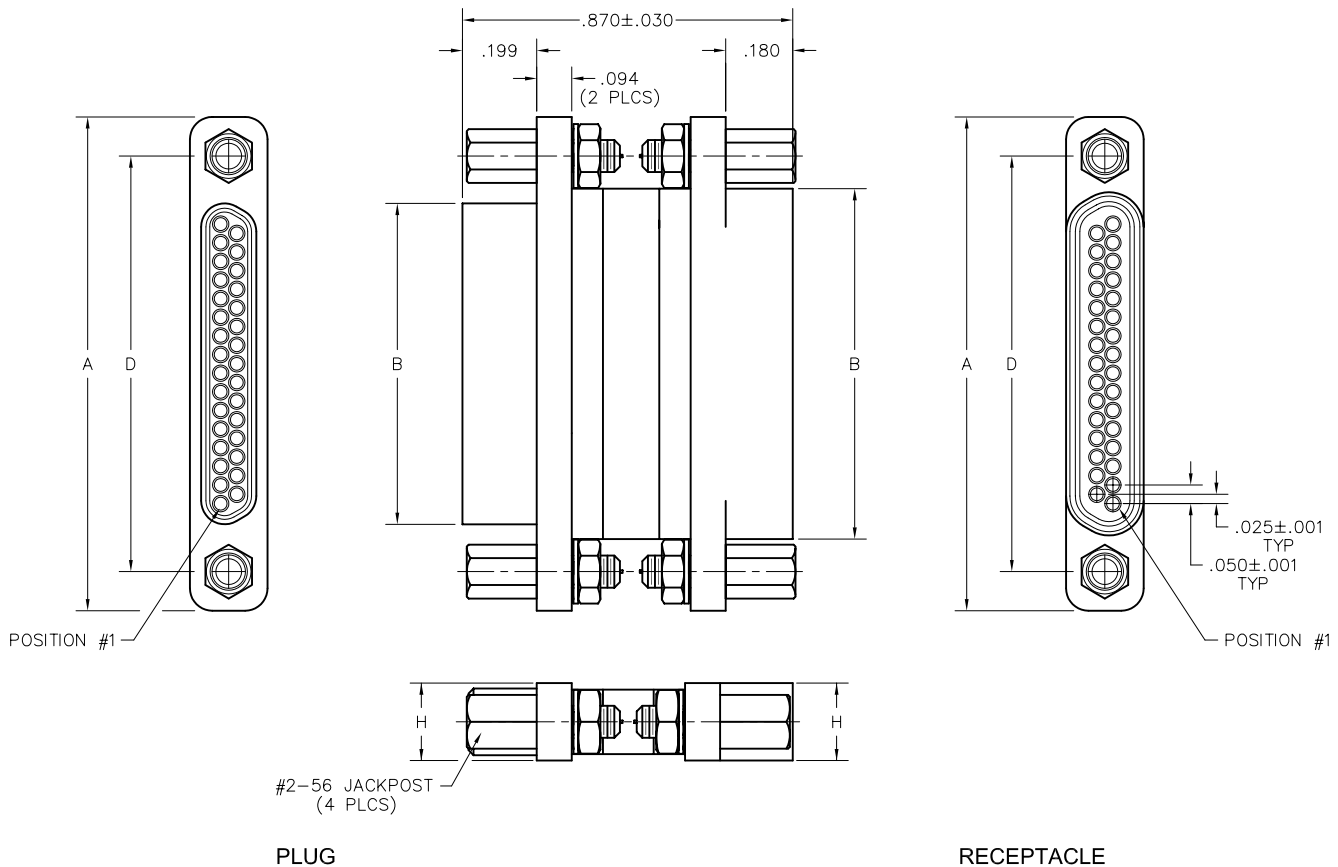
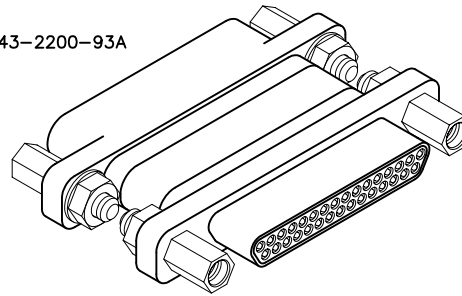

SIZE	CONTACT ROWS	DIMENSIONS					HARDWARE
		A	B		D	H ±.005	
			PLUG MAX	RCPT MAX			
9	2	.778	.292	.378	.565	.208	#2-56 UNC THD (.092 DIA THRU)
15		.928	.442	.528	.715		
21		1.078	.592	.678	.865		
25		1.178	.692	.778	.965		
31		1.328	.842	.928	1.115		
37		1.478	.992	1.078	1.265		
51	3	1.428	.942	1.028	1.215	.250	

PLUG/RECEPTACLE: MQ- 212 - 031 - 143 - 2200 - 93A
 MP- 211 - 031 - 143 - 2200 - 93A
 XX-XXX-XXX-XXX-XXXX-XXX

SERIES

MQ .050" Low Profile Metal
 MP .050" Low Profile Plastic

BODY

- 2 2-Row (Sizes 9 thru 37)
- 3 3-Row (Size 51)

BODY STYLE:

- 1 Plug/Receptacle, straight with mounting ears

BODY MATERIAL:

- 1 Polyphenylene Sulfide (MN only)
- 2 Polyphenylene Sulfide with electroless nickel shell
- 3 Polyphenylene Sulfide with electrodeposited cadmium shell ☒
- 4 Polyphenylene Sulfide with hard anodized back shell

SIZE

XXX 009, 015, 021, 025, 031, 037, 051

CONTACTS

TYPE CONTACTS/TERMINATIONS:

- 14 Pin/Socket, straight

PLATING OPTIONS:

- 3 50 μ" Au contacts: 10 μ" Au terminations

HARDWARE

STYLE OF HARDWARE:

- 00 None
- 22 Two fixed jacknut assemblies
- JA Turning jackpost with retaining ring, uninstalled
- JP Turning jackpost, internal thread on plug side
- JS Turning jackpost, internal thread on receptacle side

POLARIZATION / WIRING:

- 00 None

SPECIAL DESIGNATORS

93A Connector saver designator

☒ = Option not RoHS compliant

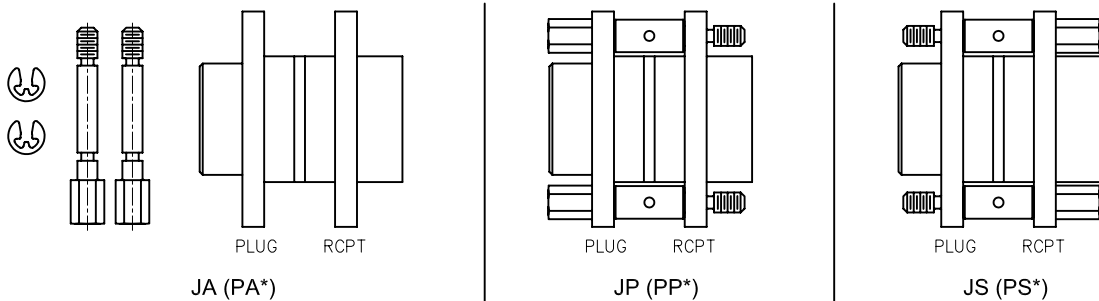



EMI/RFI Straight Backshells

.050"

9 thru 100 Contacts

Rugged Metal

MM

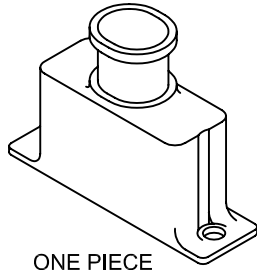

ONE PIECE
(POSITIONS 9-100)

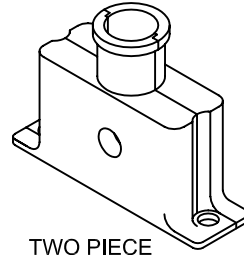

TWO PIECE
(POSITIONS 9 & 15)

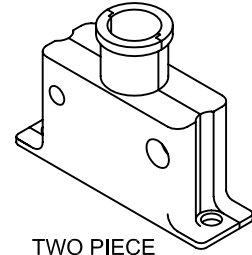

TWO PIECE
(POSITIONS 21-100)

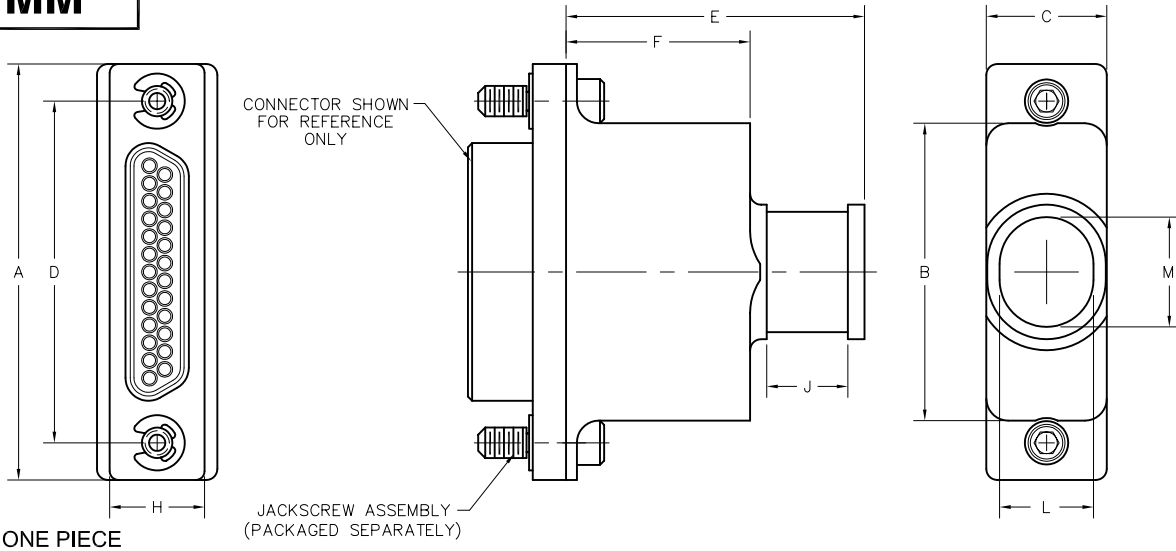

ONE PIECE

DIMENSIONS												
SIZE	CONTACT ROWS	A	B	C	D	E	F	H	J	L	M	HARDWARE
9	2	.775	.440	.340	.565	.843	.520	.298	.229	SEE TABLE A (RIGHT)		#2-56 UNC THD (.092 DIA THRU)
15		.925	.590		.715							
21		1.075	.740		.865							
25		1.175	.840		.965							
31		1.325	.990		1.115							
37		1.475	1.140		1.265							
51		1.825	1.490		1.615							
51	3	1.425	1.090	.380	1.215	.933	.610	.341				
69		1.725	1.390		1.515							
100		2.160	1.522		.430							1.800

TWO PIECE

DIMENSIONS												
SIZE	CONTACT ROWS	A	B	C	D	E	F	H	J	L	M	HARDWARE
9	2	.775	.480	.340	.565	.843	.520	.298	.229	SEE TABLE A (RIGHT)		#2-56 UNC THD (.092 DIA THRU)
15		.925	.630		.715							
21		1.075	.780		.865							
25		1.175	.880		.965							
31		1.325	1.030		1.115							
37		1.475	1.180		1.265							
51		1.825	1.530		1.615							
51	3	1.425	1.130	.380	1.215	.933	.610	.341				
69		1.725	1.430		1.515							
100		2.160	1.528		.430							1.800

Call (972) 931-3200 · Fax (972) 931-9305 · www.AirBorn.com

RUGGED: MM-252-031-000-4100
 XX-XXX-XXX-XXX-XXXX-XXX

SERIES	
MM	.050" Rugged Metal Backshell
BODY	
2	2-Row (Sizes 9 thru 51)
3	3-Row (Sizes 51 & 69)
4	4-Row (Size 100)
BODY STYLE:	
3	Straight, one piece
5	Straight, two piece***
BODY MATERIAL:	
2	Aluminum, with electroless nickel plating
3	Aluminum, with electrodeposited cadmium <input checked="" type="checkbox"/>
4	Aluminum, with hard anodized black plating
SIZE	
XXX	009, 015, 021, 025, 031, 037, 051, 069, 100
EXIT	
000	Standard exit, see Table A
AAA	Large exit, see Table A**
BBB	Small exit, see Table A**
HARDWARE	
STYLE OF HARDWARE:	
00	None
22	Two fixed jacknut assemblies (62*)
41	Two turning jackscrews, allen head, retaining ring (81*)
43	Two turning jackscrews, slot head, retaining ring (83*)
44	Two long turning jackscrews, slot head, retaining ring (84*)
POLARIZATION / WIRING:	
00	None
OPTIONS	
0FZ	Required for receptacles with grounding fingers when ordering hardware styles 41, 43, 44, 81, 83, & 84

* = Use number in parenthesis when ordering size 100.
 ** = Available with Body Style 3 (one piece) only.
 *** = Sizes 9 and 15 not recommended for solder cup applications or 24 AWG wire applications.

Stainless steel micro band for shield termination - AirBorn part number CDG10026, shipped with each backshell
 Band-it application tool - AirBorn part number CDG10027

= Option not ROHS compliant

TABLE A

SIZE	EXIT DIMENSIONS					
	000		AAA		BBB	
	L	M	L	M	L	M
9	—	.188	.265	.310	—	.129
15	—	.230		.458	—	.162
21	—	.257		.608	—	.188
25	.265	.310		.708	—	.206
31		.330		.858	—	.225
37		.375	1.008	—	.242	
51		.515	1.034	.265	.300	
51	.297	.470	.297	.921	—	.290
69		.620		1.158	.297	.361
100		.344		.688	.344	1.342

Ask About AirBorn's Accelerated Delivery Service



EMI/RFI 45° Backshells

.050"
9 thru 100 Contacts

Rugged Metal

MM

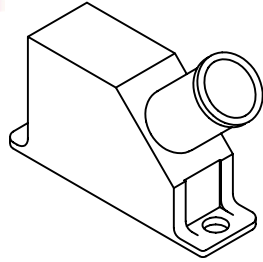

MM, 45°
(ONE PIECE)

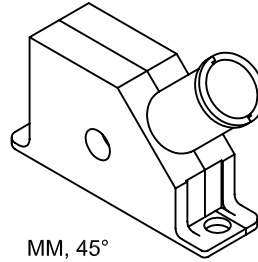

MM, 45°
(TWO PIECE)
(POSITIONS 9 & 15)

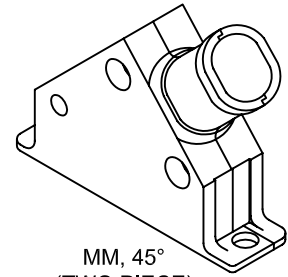

MM, 45°
(TWO PIECE)
(POSITIONS 21 - 100)

Note: 21 & 25 position, 2 piece backshells use two screw clamping configurations.

MM, 45° (ONE PIECE)

DIMENSIONS													
SIZE	CONTACT ROWS	A	B	C	D	E	F	H	J	K	L	M	HARDWARE
9	2	.775	.440	.340	.565	.696	.500	.298	.229	.804	—	.188	#2-56 UNC THD (.092 DIA THRU)
15		.925	.590		.715	.721	.525			.954	—	.230	
21		1.075	.740		.865	.746	.550			1.103	—	.257	
25		1.175	.840		.965	.796	.600			1.203	.265	.310	
31		1.325	.990		1.115	.846	.650			1.353		.330	
37		1.475	1.140		1.265	.921	.725			1.503	.375		
51	3	1.825	1.490	.380	1.615	1.144	.950	.341	.297	1.853	.510	.620	#4-40 UNC THD (.147 DIA THRU)
51		1.425	1.090		1.215	.946	.750			1.453	.470		
69		1.725	1.390		1.515	.750	.341			1.753	.620		
100	4	2.160	1.522	.430	1.800	1.146	.950	.384		2.036	.344	.688	#4-40 UNC THD (.147 DIA THRU)

MM, 45° (TWO PIECE)

DIMENSIONS													
SIZE	CONTACT ROWS	A	B	C	D	E	F	H	J	K	L	M	HARDWARE
9	2	.775	.480	.340	.565	.855	.650	.298	.229	.806	—	.188	#2-56 UNC THD (.092 DIA THRU)
15		.925	.630		.715	.831	.625			.944	—	.230	
21		1.075	.780		.865	.985	.421			1.059	.240	.268	
25		1.175	.880		.965	1.031	.400			1.159		.333	
31		1.325	1.030		1.115	1.046				1.309	.354		
37		1.475	1.180		1.265	1.081	1.459			.404			
51	3	1.825	1.530	.380	1.615	1.193	.625	.341	.280	1.809	.559	.642	#4-40 UNC THD (.147 DIA THRU)
51		1.425	1.130		1.215	1.233				1.409	.492		
69		1.725	1.430		1.515	1.378				1.703	.642		
100	4	2.160	1.522	.430	1.800	1.403	.532	.384		1.973	.330	.711	#4-40 UNC THD (.147 DIA THRU)

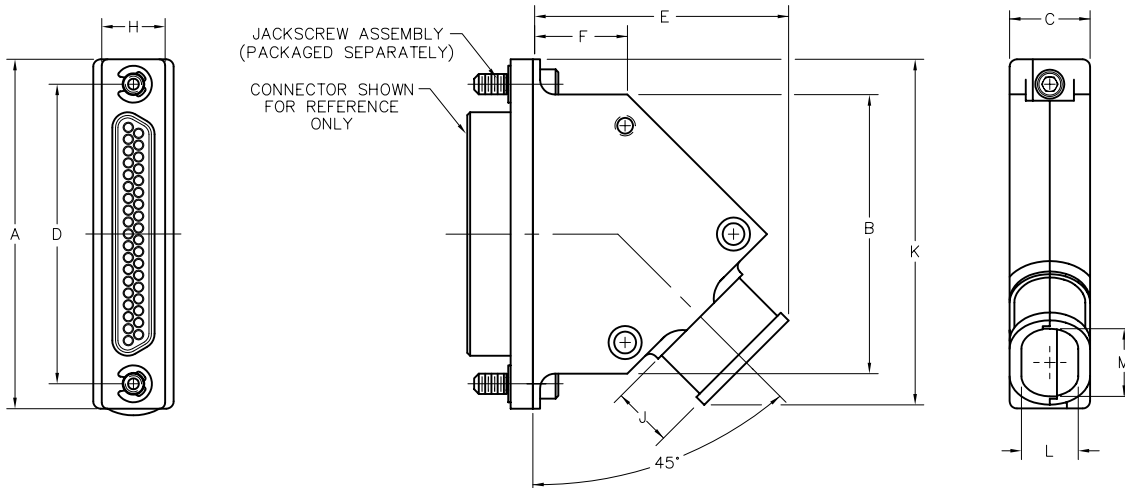

RUGGED: MM-242-031-000-4100
 XX-XXX-XXX-XXX-XXXX-XXX

SERIES	
MM	.050" Rugged Metal Backshell
BODY	
2	2-Row (Sizes 9 thru 51)
3	3-Row (Sizes 51 & 69)
4	4-Row (Size 100)
BODY STYLE:	
4	45°, one piece
6	45°, two piece **
BODY MATERIAL:	
2	Aluminum, with electroless nickel plating
3	Aluminum, with electrodeposited cadmium ☒
4	Aluminum, with hard anodized black plating
SIZE	
XXX	009, 015, 021, 025, 031, 037, 051, 069, 100
CONTACTS	
TYPE CONTACTS/TERMINATIONS:	
000	None
HARDWARE	
STYLE OF HARDWARE:	
00	None
22	Two fixed jacknut assemblies (62*)
41	Two turning jackscrews, allen head, retaining ring (81*)
43	Two turning jackscrews, slot head, retaining ring (83*)
POLARIZATION / WIRING:	
00	None
OPTIONS	
0FZ	Required for receptacles with grounding fingers when ordering hardware styles 41, 43, 81, & 83

* = Use number in parenthesis when ordering size 100.
 ** = Sizes 9 and 15 not recommended for solder cup applications.

Stainless steel micro band for shield termination - AirBorn part number CDG10026
 Band-it application tool - AirBorn part number CDG10027

☒ = Option not RoHS compliant

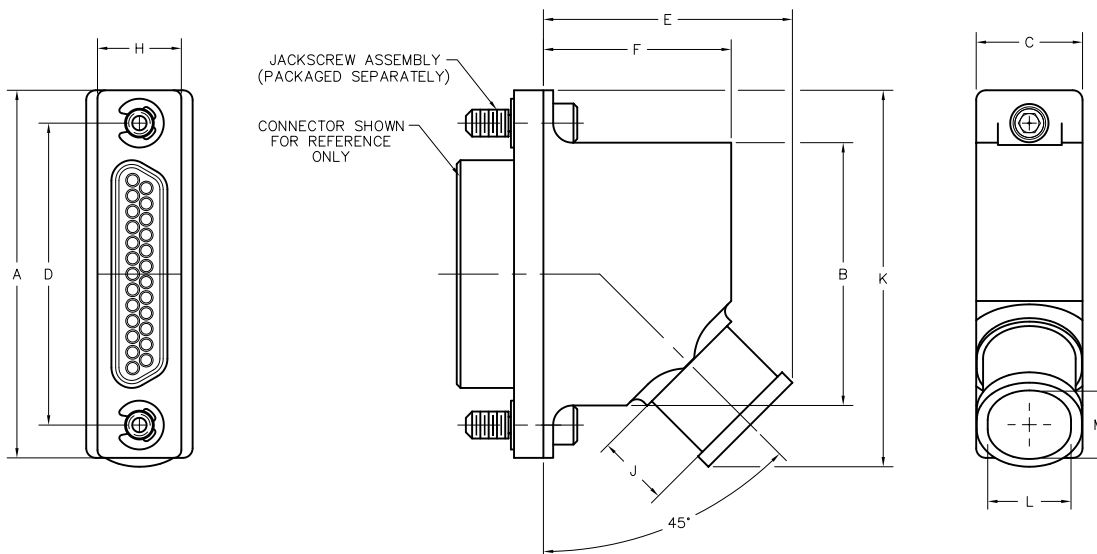



EMI/RFI 90° Backshells

.050"
9 thru 100 Contacts

Rugged Metal

MM

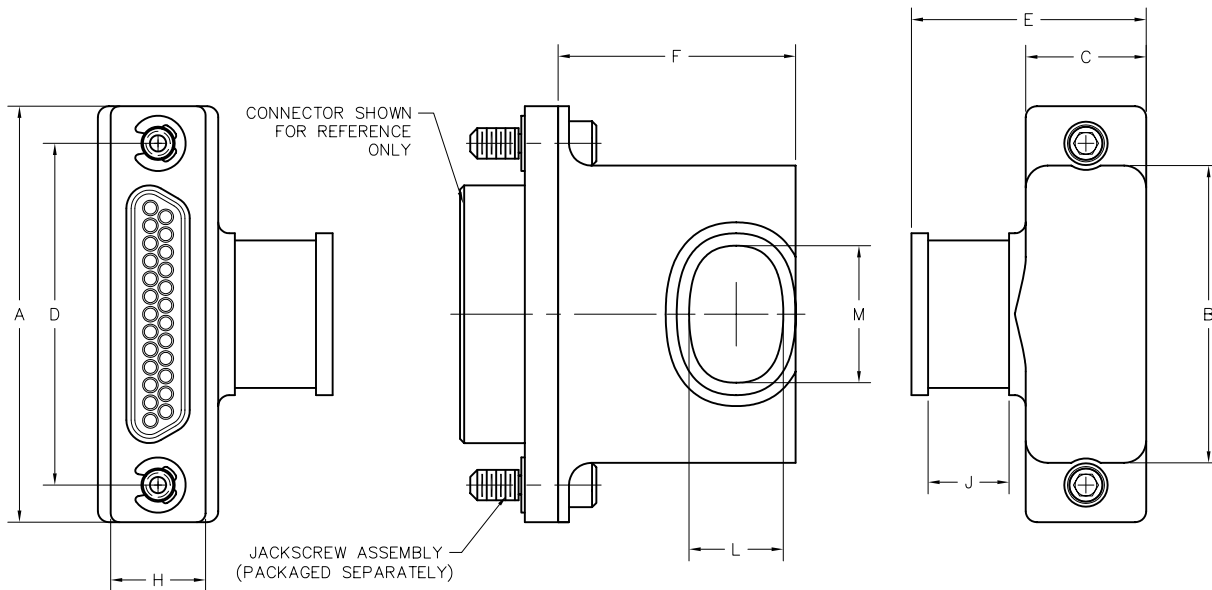
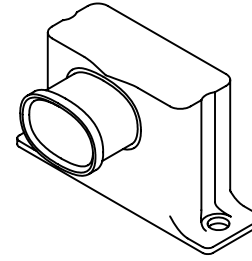

ONE PIECE

DIMENSIONS												
SIZE	CONTACT ROWS	A	B	C	D	E	F	H	J	L	M	HARDWARE
9	2	.775	.440	.340	.565	.663	.671	.298	.229	.266	.268	#2-56 UNC THD (.092 DIA THRU)
15		.925	.590		.715						.311	
21		1.075	.740		.865						.331	
25		1.175	.840		.965						.387	
31		1.325	.990		1.115						.450	
37		1.475	1.140		1.265						.511	
51	3	1.825	1.490	.380	1.615	.703	.703	.341	.298	.678	.619	
51		1.425	1.090		1.215					.823		
69		1.725	1.390		1.515							
100		4	2.160		1.522					.430	1.800	.753

RUGGED: MM-272-031-000-4100
 XX-XXX-XXX-XXX-XXXX

SERIES	
MM	.050" Rugged Metal Backshell
BODY	
2	2-Row (Sizes 9 thru 51)
3	3-Row (Sizes 51 & 69)
4	4-Row (Size 100)
BODY STYLE:	
7	90°, one piece
BODY MATERIAL:	
2	Aluminum, with electroless nickel plating
3	Aluminum, with electrodeposited cadmium <input checked="" type="checkbox"/>
4	Aluminum, with hard anodized black plating
SIZE	
XXX	009, 015, 021, 025, 031, 037, 051, 069, 100
EXIT	
000	Standard exit**
HARDWARE	
STYLE OF HARDWARE:	
00	None
22	Two fixed jacknut assemblies (62*)
41	Two turning jackscrews, allen head, retaining ring (81*)
43	Two turning jackscrews, slot head, retaining ring (83*)
44	Two long turning jackscrews, slot head, retaining ring (84*)
POLARIZATION / WIRING:	
00	None

* = Use number in parenthesis when ordering size 100.
 ** = Backshell exits are designed to accommodate 26AWG wire or smaller

Stainless steel micro band for shield termination - AirBorn part number CDG10026, shipped with each backshell
 Band-it application tool - AirBorn part number CDG10027

= Option not ROHS compliant



EMI/RFI Straight Backshells

.050"

9 thru 51 Contacts

Low Profile Metal

MQ

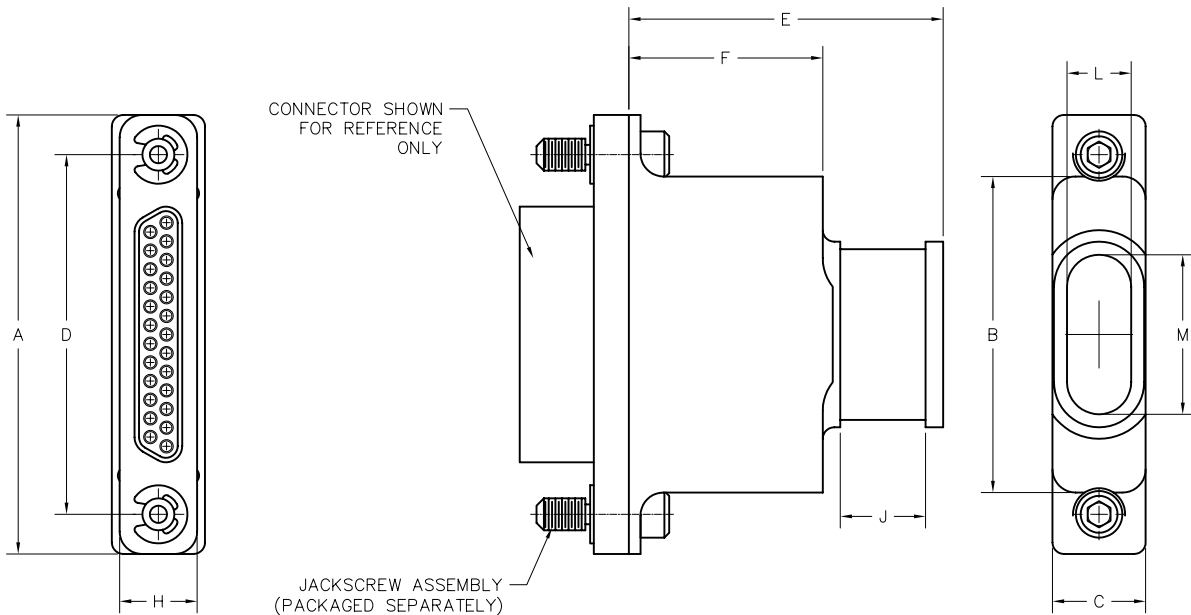
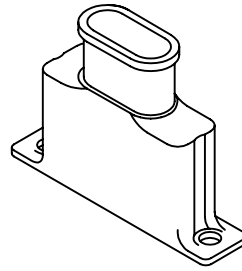

ONE PIECE

DIMENSIONS												
SIZE	CONTACT ROWS	A	B	C	D	E	F	H	J	L	M	HARDWARE
9	2	.778	.448	.250	.565	.843	.520	.208	.229	.172	.197	#2-56 UNC THD (.092 DIA THRU)
15		.928	.598		.715						.279	
21		1.078	.748		.865						.339	
25		1.178	.848		.965						.428	
31		1.328	.998		1.115						.462	
37		1.478	1.148		1.265						.531	
51	3	1.428	1.098	.292	1.215	.933	.610	.250		.220	.596	

RUGGED: MQ-232-025-000-4100
 XX-XXX-XXX-XXX-XXXX

SERIES	
MQ	.050" Low Profile Metal Backshell
BODY	
2	2-Row (Sizes 9 thru 37)
3	3-Row (Sizes 51)
BODY STYLE:	
3	Straight, one piece
BODY MATERIAL:	
2	Aluminum, with electroless nickel plating
3	Aluminum, with electrodeposited cadmium <input checked="" type="checkbox"/>
4	Aluminum, with hard anodized black plating
SIZE	
XXX	009, 015, 021, 025, 031, 037, 051
EXIT	
000	Standard exit
HARDWARE	
STYLE OF HARDWARE:	
00	None
22	Two fixed jacknut assemblies
41	Two turning jackscrews, allen head, retaining ring
43	Two turning jackscrews, slot head, retaining ring
44	Two long turning jackscrews, slot head, retaining ring
POLARIZATION / WIRING:	
00	None

Stainless steel micro band for shield termination - AirBorn part number CDG10026, shipped with each backshell
 Band-it application tool - AirBorn part number CDG10027

= Option not ROHS compliant



Dust Covers

.050"

9 thru 100 Contacts

Rugged Metal

MD

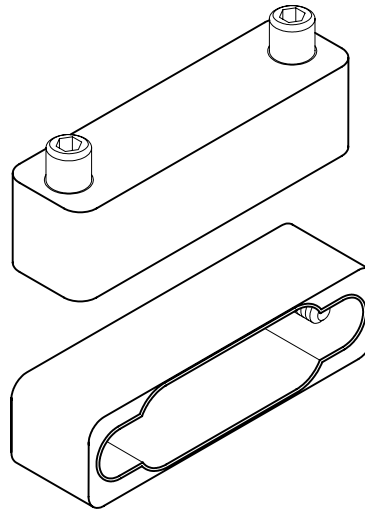

MD021RSM245

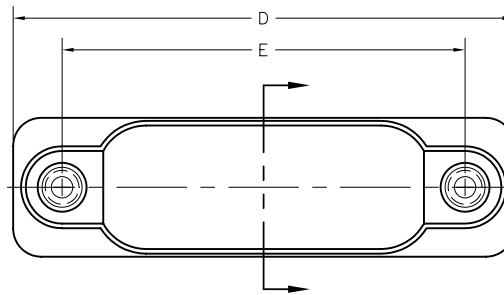
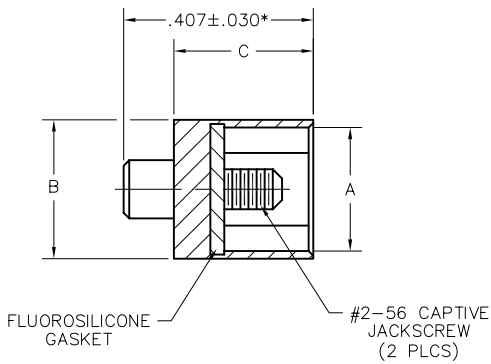

DIMENSIONS								
SIZE	A		B		C	D	E	HARDWARE
	PLUG	RCPT	PLUG	RCPT				
9	.203	.265	.298	.298	.299	.775	.565	#2-56 UNC THD
15						.925	.715	
21						1.075	.865	
25						1.175	.965	
31						1.325	1.115	
37						1.475	1.265	
51	.246	.308	.341	.341		1.425	1.215	
69						1.725	1.515	
100	.291	.394	.381	.434		2.152	1.800	#4-40 UNC THD

* = 100 POS DIMENSION .460±.030

PLUG		RECEPTACLE		RECEPTACLE: MD 021 RS M2 45 XX XXX XX XX XX				
SERIES								
MD .050" Rugged Metal Dust Cover		MD .050" Rugged Metal Dust Cover						
SIZE								
XXX 009, 015, 021, 025, 031, 037, 051, 069, 100		XXX 009, 015, 021, 025, 031, 037, 051, 069, 100						
STYLE								
RP Plug, rugged metal		RS Receptacle, rugged metal						
PLATING								
M2 Electroless nickel		M2 Electroless nickel						
M3 Electrodeposited cadmium <input checked="" type="checkbox"/>		M3 Electrodeposited cadmium <input checked="" type="checkbox"/>						
M4 Hard anodized black		M4 Hard anodized black						
HARDWARE								
STYLE OF HARDWARE:		STYLE OF HARDWARE:						
22 Two integrated jacknuts (62")		22 Two integrated jacknuts (62")						
45 Two turning jackscrews, allen head, captivated** (85*)		45 Two turning jackscrews, allen head, captivated** (85*)						

* = Use number in parenthesis when ordering size 100.
 ** = Captive hardware is factory installed and non-removable.

Not for use with rear panel mount connectors
 Not for use on receptacles with grounding fingers

= Option not RoHS compliant



ESD Dust Covers

.050"

9 thru 100 Contacts

Rugged Metal
Low Profile Plastic

MD

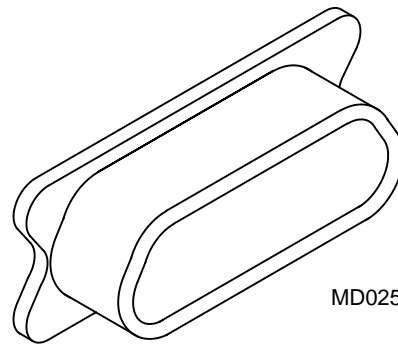

MD025RS

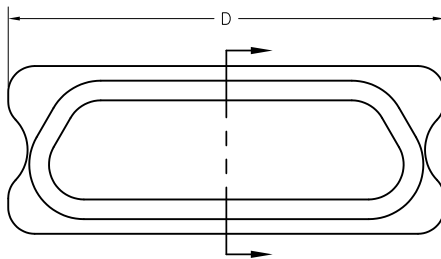
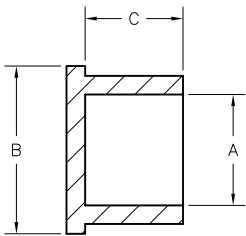

EXAMPLE: MD025RS
MDXXXXX

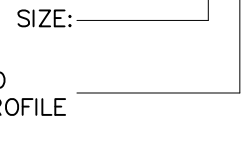

- R – RUGGED
- L – LOW PROFILE
- P – PLUG
- S – RECEPTACLE

Material: Carbon filled polypropylene
 Static Decay meets MIL-PRF-81705D
 Surface Resistivity per ASTM D 257-99(2005): $<1.0 \times 10^{12}$ ohms/square

RUGGED PLASTIC

SIZE	CONTACT ROWS	DIMENSIONS									
		A		B		C		D		PART NUMBER	
		PLUG	RCPT	PLUG	RCPT	PLUG	RCPT	PLUG	RCPT	PLUG	RCPT
9	2	.176	.238	.298	.360	.195	.215	.475	.460	MD009RP	MD009RS
15								.625	.610	MD015RP	MD015RS
21								.775	.760	MD021RP	MD021RS
25								.875	.860	MD025RP	MD025RS
31								1.025	1.010	MD031RP	MD031RS
37								1.175	1.160	MD037RP	MD037RS
51								1.525	1.510	MD051RP-2	MD051RS-2
51								3	.219	.281	.340
69	4	.265	.379	.385	.500	1.425	1.410	MD069RP	MD069RS		
100						1.500	1.615	MD100RP	MD100RS		

LOW PROFILE PLASTIC

SIZE	CONTACT ROWS	DIMENSIONS									
		A		B		C		D		PART NUMBER	
		PLUG	RCPT	PLUG	RCPT	PLUG	RCPT	PLUG	RCPT	PLUG	RCPT
9	2	.125	.205	.256	.315	.210	.195	.400	.430	MD009LP	MD009LS
15								.550	.580	MD015LP	MD015LS
21								.700	.730	MD021LP	MD021LS
25								.800	.830	MD025LP	MD025LS
31								.950	.980	MD031LP	MD031LS
37								1.100	1.130	MD037LP	MD037LS
51								1.050	1.080	MD051LP	MD051LS

Not for use on receptacles with grounding fingers

O-Rings, Fluorosilicone & Butyl

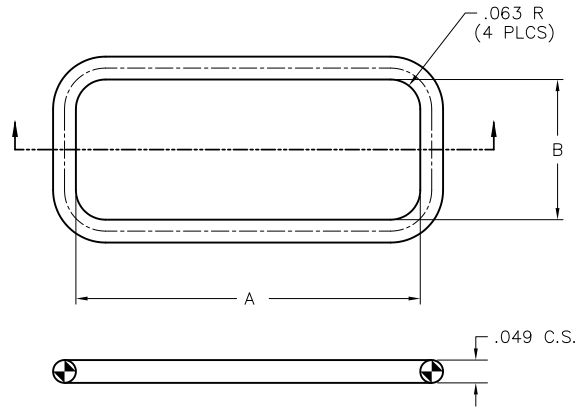

DIMENSIONS (Ref Only)			
SIZE	CONTACT ROWS	A	B
9	2	.739	.301
15		.889	
21		1.039	
25		1.139	
31		1.297	
37		1.439	
51	3	1.439	.344
69		1.731	
100	4	2.159	.421

FLUOROSILICONE	
SIZE	P/N
9	CDG17148
15	CDG17149
21	CDG17150
25	CDG17151
31	CDG17152
37	CDG17153
51	CDG17154
69	CDG17155
100	CDG17156

BUTYL	
SIZE	P/N
9	CDG17478
15	CDG17479
21	CDG17480
25	CDG17481
31	CDG17482
37	CDG17483
51	CDG17484
69	CDG17485
100	CDG17486

EMI Gasket, Fluorosilicone

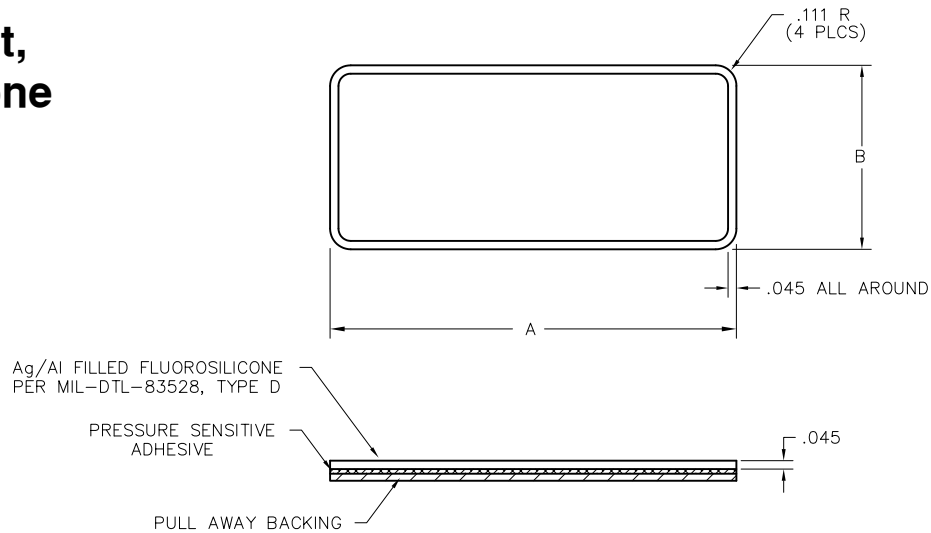

DIMENSIONS (Ref Only)			
SIZE	CONTACT ROWS	A	B
9	2	.872	.395
15		1.022	
21		1.172	
25		1.272	
31		1.422	
37		1.572	
51	3	1.572	.438
69		1.872	
100	4	2.298	.515

PART NUMBERS	
SIZE	P/N
9	CDG15933
15	CDG15934
21	CDG15935
25	CDG15936
31	CDG15937
37	CDG13044
51	CDG15938
69	CDG12978
100	CDG15939

Hardware

MM - MN - MQ - MP Rear Panel Mount Hardware for Standard I/O Connectors

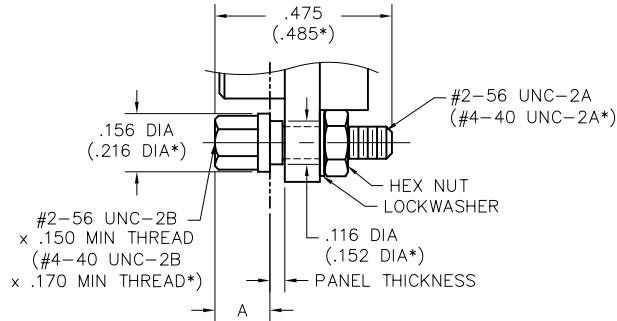

PANEL THK	THREAD SIZE	PART NUMBER	A MAX
.040	#2-56	MM-000-000-000-2400-OF4	.150
.050		MM-000-000-000-2500-OF5	.140
.060		MM-000-000-000-2600-OF6	.130
.070		MM-000-000-000-2800-OF7	.120
.080		MM-000-000-000-2900-OF8	.110
.040	#4-40	MM-000-000-000-6400-OF9	.150
.050		MM-000-000-000-6500-0FA	.140
.060		MM-000-000-000-6600-0FB	.130
.070		MM-000-000-000-6800-0FC	.120
.080		MM-000-000-000-6900-0FD	.110

* = Dimensions for 100 position connectors

MM - MN - MQ - MP Rear Panel Mount Hardware for I/O Connectors with Grounding Fingers, Integrated Shield Termination, or I/O with EMI/RFI Backshell

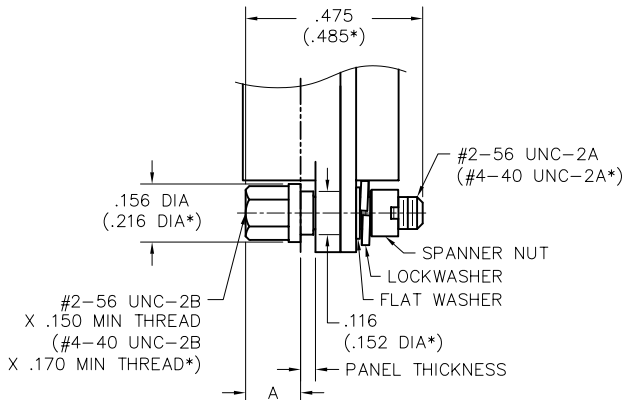

PANEL THK	THREAD SIZE	PART NUMBER	A MAX
.040	#2-56	MM-000-000-000-2400-0G7	.150
.050		MM-000-000-000-2500-0G7	.140
.060		MM-000-000-000-2600-0G7	.130
.070		MM-000-000-000-2800-0G7	.120
.080		MM-000-000-000-2900-0G7	.110
.040	#4-40	MM-000-000-000-6400-0G7	.150
.050		MM-000-000-000-6500-0G7	.140
.060		MM-000-000-000-6600-0G7	.130
.070		MM-000-000-000-6800-0G7	.120
.080		MM-000-000-000-6900-0G7	.110

* = Dimensions for 100 position connectors

Panel Mounting Dimensions for Receptacles With Grounding Fingers

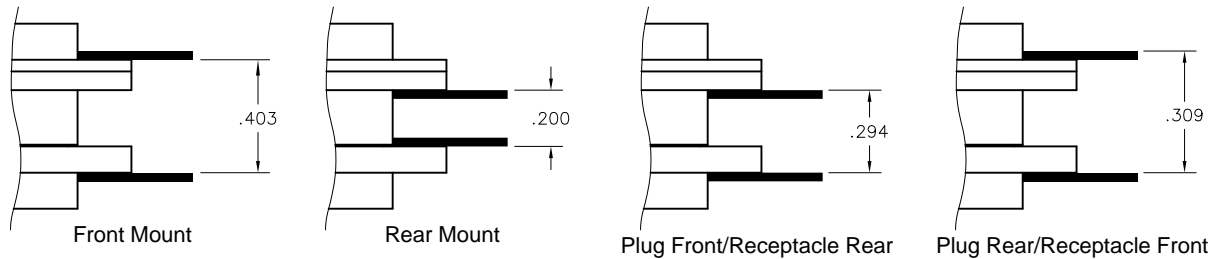

Front Panel Mounting Receptacles With Grounding Fingers

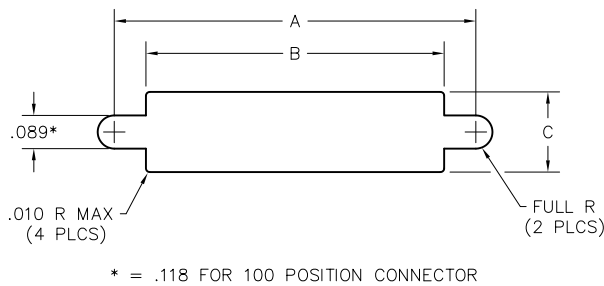

DIMENSIONS				
SIZE	A +.004 -.000	B +.005 -.000	C +.004 -.000	
			MP, MQ, MR, MS MQHT, MSHT	MK, ML, MM, MN MKHT, MMHT
9	.570	.400	.215	.273
15	.720	.550		
21	.870	.700		
25	.970	.800		
31	1.120	.950		
37	1.270	1.100	.256	.311
51	1.220	1.050		
69	1.520	1.350		
100	1.805	1.442	---	.383

Rear Panel Mounting Receptacles With Grounding Fingers

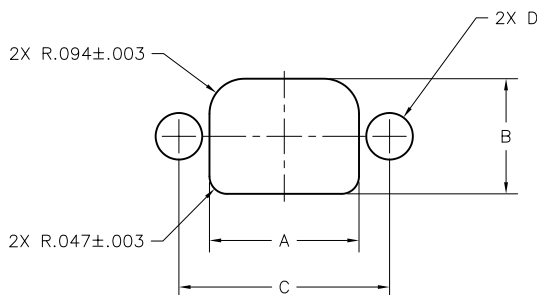

DIMENSIONS				
SIZE	A +.004 -.000	B +.004 -.000	C ±.005	D ±.005 THRU
9	.401	.308	.565	.125
15	.551		.715	
21	.701		.865	
25	.801		.965	
31	.951		1.115	
37	1.101	.351	1.265	
51	1.051		1.215	
69	1.351		1.515	
100	1.505	.391	1.800	.160

MILITARY CROSS REFERENCE

M83513 / 01

M83513 / 01 - AC	MM-213-009-113-0000	M83513 / 01 - DC	MM-213-025-113-0000	M83513 / 01 - GC	MM-313-051-113-0000
M83513 / 01 - AN	MM-212-009-113-0000	M83513 / 01 - DN	MM-212-025-113-0000	M83513 / 01 - GN	MM-312-051-113-0000
M83513 / 01 - AP	MM-215-009-113-0000	M83513 / 01 - DP	MM-215-025-113-0000	M83513 / 01 - GP	MM-315-051-113-0000
M83513 / 01 - BC	MM-213-015-113-0000	M83513 / 01 - EC	MM-213-031-113-0000	M83513 / 01 - HC	MM-413-100-113-0000
M83513 / 01 - BN	MM-212-015-113-0000	M83513 / 01 - EN	MM-212-031-113-0000	M83513 / 01 - HN	MM-412-100-113-0000
M83513 / 01 - BP	MM-215-015-113-0000	M83513 / 01 - EP	MM-215-031-113-0000	M83513 / 01 - HP	MM-415-100-113-0000
M83513 / 01 - CC	MM-213-021-113-0000	M83513 / 01 - FC	MM-213-037-113-0000		
M83513 / 01 - CN	MM-212-021-113-0000	M83513 / 01 - FN	MM-212-037-113-0000		
M83513 / 01 - CP	MM-215-021-113-0000	M83513 / 01 - FP	MM-215-037-113-0000		

M83513 / 02

M83513 / 02 - AC	MM-223-009-213-0000-900	M83513 / 02 - DC	MM-223-025-213-0000-900	M83513 / 02 - GC	MM-323-051-213-0000-900
M83513 / 02 - AN	MM-222-009-213-0000-900	M83513 / 02 - DN	MM-222-025-213-0000-900	M83513 / 02 - GN	MM-322-051-213-0000-900
M83513 / 02 - AP	MM-225-009-213-0000-900	M83513 / 02 - DP	MM-225-025-213-0000-900	M83513 / 02 - GP	MM-325-051-213-0000-900
M83513 / 02 - BC	MM-223-015-213-0000-900	M83513 / 02 - EC	MM-223-031-213-0000-900	M83513 / 02 - HC	MM-423-100-213-0000-900
M83513 / 02 - BN	MM-222-015-213-0000-900	M83513 / 02 - EN	MM-222-031-213-0000-900	M83513 / 02 - HN	MM-422-100-213-0000-900
M83513 / 02 - BP	MM-225-015-213-0000-900	M83513 / 02 - EP	MM-225-031-213-0000-900	M83513 / 02 - HP	MM-425-100-213-0000-900
M83513 / 02 - CC	MM-223-021-213-0000-900	M83513 / 02 - FC	MM-223-037-213-0000-900		
M83513 / 02 - CN	MM-222-021-213-0000-900	M83513 / 02 - FN	MM-222-037-213-0000-900		
M83513 / 02 - CP	MM-225-021-213-0000-900	M83513 / 02 - FP	MM-225-037-213-0000-900		

M83513 / 03

M83513 / 03-A01C	MM-213-009-161-00W1	M83513 / 03-A12C	MM-213-009-161-00Y4	M83513 / 03-B06P	MM-215-015-153-0000
M83513 / 03-A01N	MM-212-009-161-00W1	M83513 / 03-A12N	MM-212-009-161-00Y4	M83513 / 03-B07C	MM-213-015-145-0000
M83513 / 03-A01P	MM-215-009-161-00W1	M83513 / 03-A12P	MM-215-009-161-00Y4	M83513 / 03-B07N	MM-212-015-145-0000
M83513 / 03-A02C	MM-213-009-161-00W2	M83513 / 03-A13C	MM-213-009-161-00Y5	M83513 / 03-B07P	MM-215-015-145-0000
M83513 / 03-A02N	MM-212-009-161-00W2	M83513 / 03-A13N	MM-212-009-161-00Y5	M83513 / 03-B08C	MM-213-015-155-0000
M83513 / 03-A02P	MM-215-009-161-00W2	M83513 / 03-A13P	MM-215-009-161-00Y5	M83513 / 03-B08N	MM-212-015-155-0000
M83513 / 03-A03C	MM-213-009-161-00V1	M83513 / 03-A14C	MM-213-009-161-00Y6	M83513 / 03-B08P	MM-215-015-155-0000
M83513 / 03-A03N	MM-212-009-161-00V1	M83513 / 03-A14N	MM-212-009-161-00Y6	M83513 / 03-B09C	MM-213-015-161-00Y1
M83513 / 03-A03P	MM-215-009-161-00V1	M83513 / 03-A14P	MM-215-009-161-00Y6	M83513 / 03-B09N	MM-212-015-161-00Y1
M83513 / 03-A04C	MM-213-009-161-00V2	M83513 / 03-A15C	MM-213-009-161-00Y7	M83513 / 03-B09P	MM-215-015-161-00Y1
M83513 / 03-A04N	MM-212-009-161-00V2	M83513 / 03-A15N	MM-212-009-161-00Y7	M83513 / 03-B10C	MM-213-015-161-00Y2
M83513 / 03-A04P	MM-215-009-161-00V2	M83513 / 03-A15P	MM-215-009-161-00Y7	M83513 / 03-B10N	MM-212-015-161-00Y2
M83513 / 03-A05C	MM-213-009-143-0000	M83513 / 03-A16C	MM-213-009-161-00Y8	M83513 / 03-B10P	MM-215-015-161-00Y2
M83513 / 03-A05N	MM-212-009-143-0000	M83513 / 03-A16N	MM-212-009-161-00Y8	M83513 / 03-B11C	MM-213-015-161-00Y3
M83513 / 03-A05P	MM-215-009-143-0000	M83513 / 03-A16P	MM-215-009-161-00Y8	M83513 / 03-B11N	MM-212-015-161-00Y3
M83513 / 03-A06C	MM-213-009-153-0000			M83513 / 03-B11P	MM-215-015-161-00Y3
M83513 / 03-A06N	MM-212-009-153-0000	M83513 / 03-B01C	MM-213-015-161-00W1	M83513 / 03-B12C	MM-213-015-161-00Y4
M83513 / 03-A06P	MM-215-009-153-0000	M83513 / 03-B01N	MM-212-015-161-00W1	M83513 / 03-B12N	MM-212-015-161-00Y4
M83513 / 03-A07C	MM-213-009-145-0000	M83513 / 03-B01P	MM-215-015-161-00W1	M83513 / 03-B12P	MM-215-015-161-00Y4
M83513 / 03-A07N	MM-212-009-145-0000	M83513 / 03-B02C	MM-213-015-161-00W2	M83513 / 03-B13C	MM-213-015-161-00Y5
M83513 / 03-A07P	MM-215-009-145-0000	M83513 / 03-B02N	MM-212-015-161-00W2	M83513 / 03-B13N	MM-212-015-161-00Y5
M83513 / 03-A08C	MM-213-009-155-0000	M83513 / 03-B02P	MM-215-015-161-00W2	M83513 / 03-B13P	MM-215-015-161-00Y5
M83513 / 03-A08N	MM-212-009-155-0000	M83513 / 03-B03C	MM-213-015-161-00V1	M83513 / 03-B14C	MM-213-015-161-00Y6
M83513 / 03-A08P	MM-215-009-155-0000	M83513 / 03-B03N	MM-212-015-161-00V1	M83513 / 03-B14N	MM-212-015-161-00Y6
M83513 / 03-A09C	MM-213-009-161-00Y1	M83513 / 03-B03P	MM-215-015-161-00V1	M83513 / 03-B14P	MM-215-015-161-00Y6
M83513 / 03-A09N	MM-212-009-161-00Y1	M83513 / 03-B04C	MM-213-015-161-00V2	M83513 / 03-B15C	MM-213-015-161-00Y7
M83513 / 03-A09P	MM-215-009-161-00Y1	M83513 / 03-B04N	MM-212-015-161-00V2	M83513 / 03-B15N	MM-212-015-161-00Y7
M83513 / 03-A10C	MM-213-009-161-00Y2	M83513 / 03-B04P	MM-215-015-161-00V2	M83513 / 03-B15P	MM-215-015-161-00Y7
M83513 / 03-A10N	MM-212-009-161-00Y2	M83513 / 03-B05C	MM-213-015-143-0000	M83513 / 03-B16C	MM-213-015-161-00Y8
M83513 / 03-A10P	MM-215-009-161-00Y2	M83513 / 03-B05N	MM-212-015-143-0000	M83513 / 03-B16N	MM-212-015-161-00Y8
M83513 / 03-A11C	MM-213-009-161-00Y3	M83513 / 03-B05P	MM-215-015-143-0000	M83513 / 03-B16P	MM-215-015-161-00Y8
M83513 / 03-A11N	MM-212-009-161-00Y3	M83513 / 03-B06C	MM-213-015-153-0000		
M83513 / 03-A11P	MM-215-009-161-00Y3	M83513 / 03-B06N	MM-212-015-153-0000		

Military Cross Reference Chart

-- Continued from previous page



M83513 / 03 (continued)

M83513 / 03-C01C	MM-213-021-161-00W1	M83513 / 03-D03N	MM-212-025-161-00V1	M83513 / 03-E05P	MM-215-031-143-0000
M83513 / 03-C01N	MM-212-021-161-00W1	M83513 / 03-D03P	MM-215-025-161-00V1	M83513 / 03-E06C	MM-213-031-153-0000
M83513 / 03-C01P	MM-215-021-161-00W1	M83513 / 03-D04C	MM-213-025-161-00V2	M83513 / 03-E06N	MM-212-031-153-0000
M83513 / 03-C02C	MM-213-021-161-00W2	M83513 / 03-D04N	MM-212-025-161-00V2	M83513 / 03-E06P	MM-215-031-153-0000
M83513 / 03-C02N	MM-212-021-161-00W2	M83513 / 03-D04P	MM-215-025-161-00V2	M83513 / 03-E07C	MM-213-031-145-0000
M83513 / 03-C02P	MM-215-021-161-00W2	M83513 / 03-D05C	MM-213-025-143-0000	M83513 / 03-E07N	MM-212-031-145-0000
M83513 / 03-C03C	MM-213-021-161-00V1	M83513 / 03-D05N	MM-212-025-143-0000	M83513 / 03-E07P	MM-215-031-145-0000
M83513 / 03-C03N	MM-212-021-161-00V1	M83513 / 03-D05P	MM-215-025-143-0000	M83513 / 03-E08C	MM-213-031-155-0000
M83513 / 03-C03P	MM-215-021-161-00V1	M83513 / 03-D06C	MM-213-025-153-0000	M83513 / 03-E08N	MM-212-031-155-0000
M83513 / 03-C04C	MM-213-021-161-00V2	M83513 / 03-D06N	MM-212-025-153-0000	M83513 / 03-E08P	MM-215-031-155-0000
M83513 / 03-C04N	MM-212-021-161-00V2	M83513 / 03-D06P	MM-215-025-153-0000	M83513 / 03-E09C	MM-213-031-161-00Y1
M83513 / 03-C04P	MM-215-021-161-00V2	M83513 / 03-D07C	MM-213-025-145-0000	M83513 / 03-E09N	MM-212-031-161-00Y1
M83513 / 03-C05C	MM-213-021-143-0000	M83513 / 03-D07N	MM-212-025-145-0000	M83513 / 03-E09P	MM-215-031-161-00Y1
M83513 / 03-C05N	MM-212-021-143-0000	M83513 / 03-D07P	MM-215-025-145-0000	M83513 / 03-E10C	MM-213-031-161-00Y2
M83513 / 03-C05P	MM-215-021-143-0000	M83513 / 03-D08C	MM-213-025-155-0000	M83513 / 03-E10N	MM-212-031-161-00Y2
M83513 / 03-C06C	MM-213-021-153-0000	M83513 / 03-D08N	MM-212-025-155-0000	M83513 / 03-E10P	MM-215-031-161-00Y2
M83513 / 03-C06N	MM-212-021-153-0000	M83513 / 03-D08P	MM-215-025-155-0000	M83513 / 03-E11C	MM-213-031-161-00Y3
M83513 / 03-C06P	MM-215-021-153-0000	M83513 / 03-D09C	MM-213-025-161-00Y1	M83513 / 03-E11N	MM-212-031-161-00Y3
M83513 / 03-C07C	MM-213-021-145-0000	M83513 / 03-D09N	MM-212-025-161-00Y1	M83513 / 03-E11P	MM-215-031-161-00Y3
M83513 / 03-C07N	MM-212-021-145-0000	M83513 / 03-D09P	MM-215-025-161-00Y1	M83513 / 03-E12C	MM-213-031-161-00Y4
M83513 / 03-C07P	MM-215-021-145-0000	M83513 / 03-D10C	MM-213-025-161-00Y2	M83513 / 03-E12N	MM-212-031-161-00Y4
M83513 / 03-C08C	MM-213-021-155-0000	M83513 / 03-D10N	MM-212-025-161-00Y2	M83513 / 03-E12P	MM-215-031-161-00Y4
M83513 / 03-C08N	MM-212-021-155-0000	M83513 / 03-D10P	MM-215-025-161-00Y2	M83513 / 03-E13C	MM-213-031-161-00Y5
M83513 / 03-C08P	MM-215-021-155-0000	M83513 / 03-D11C	MM-213-025-161-00Y3	M83513 / 03-E13N	MM-212-031-161-00Y5
M83513 / 03-C09C	MM-213-021-161-00Y1	M83513 / 03-D11N	MM-212-025-161-00Y3	M83513 / 03-E13P	MM-215-031-161-00Y5
M83513 / 03-C09N	MM-212-021-161-00Y1	M83513 / 03-D11P	MM-215-025-161-00Y3	M83513 / 03-E14C	MM-213-031-161-00Y6
M83513 / 03-C09P	MM-215-021-161-00Y1	M83513 / 03-D12C	MM-213-025-161-00Y4	M83513 / 03-E14N	MM-212-031-161-00Y6
M83513 / 03-C10C	MM-213-021-161-00Y2	M83513 / 03-D12N	MM-212-025-161-00Y4	M83513 / 03-E14P	MM-215-031-161-00Y6
M83513 / 03-C10N	MM-212-021-161-00Y2	M83513 / 03-D12P	MM-215-025-161-00Y4	M83513 / 03-E15C	MM-213-031-161-00Y7
M83513 / 03-C10P	MM-215-021-161-00Y2	M83513 / 03-D13C	MM-213-025-161-00Y5	M83513 / 03-E15N	MM-212-031-161-00Y7
M83513 / 03-C11C	MM-213-021-161-00Y3	M83513 / 03-D13N	MM-212-025-161-00Y5	M83513 / 03-E15P	MM-215-031-161-00Y7
M83513 / 03-C11N	MM-212-021-161-00Y3	M83513 / 03-D13P	MM-215-025-161-00Y5	M83513 / 03-E16C	MM-213-031-161-00Y8
M83513 / 03-C11P	MM-215-021-161-00Y3	M83513 / 03-D14C	MM-213-025-161-00Y6	M83513 / 03-E16N	MM-212-031-161-00Y8
M83513 / 03-C12C	MM-213-021-161-00Y4	M83513 / 03-D14N	MM-212-025-161-00Y6	M83513 / 03-E16P	MM-215-031-161-00Y8
M83513 / 03-C12N	MM-212-021-161-00Y4	M83513 / 03-D14P	MM-215-025-161-00Y6		
M83513 / 03-C12P	MM-215-021-161-00Y4	M83513 / 03-D15C	MM-213-025-161-00Y7		
M83513 / 03-C13C	MM-213-021-161-00Y5	M83513 / 03-D15N	MM-212-025-161-00Y7		
M83513 / 03-C13N	MM-212-021-161-00Y5	M83513 / 03-D15P	MM-215-025-161-00Y7		
M83513 / 03-C13P	MM-215-021-161-00Y5	M83513 / 03-D16C	MM-213-025-161-00Y8		
M83513 / 03-C14C	MM-213-021-161-00Y6	M83513 / 03-D16N	MM-212-025-161-00Y8		
M83513 / 03-C14N	MM-212-021-161-00Y6	M83513 / 03-D16P	MM-215-025-161-00Y8		
M83513 / 03-C14P	MM-215-021-161-00Y6				
M83513 / 03-C15C	MM-213-021-161-00Y7	M83513 / 03-E01C	MM-213-031-161-00W1	M83513 / 03-F01C	MM-213-037-161-00W1
M83513 / 03-C15N	MM-212-021-161-00Y7	M83513 / 03-E01N	MM-212-031-161-00W1	M83513 / 03-F01N	MM-212-037-161-00W1
M83513 / 03-C15P	MM-215-021-161-00Y7	M83513 / 03-E01P	MM-215-031-161-00W1	M83513 / 03-F01P	MM-215-037-161-00W1
M83513 / 03-C16C	MM-213-021-161-00Y8	M83513 / 03-E02C	MM-213-031-161-00W2	M83513 / 03-F02C	MM-213-037-161-00W2
M83513 / 03-C16N	MM-212-021-161-00Y8	M83513 / 03-E02N	MM-212-031-161-00W2	M83513 / 03-F02N	MM-212-037-161-00W2
M83513 / 03-C16P	MM-215-021-161-00Y8	M83513 / 03-E02P	MM-215-031-161-00W2	M83513 / 03-F02P	MM-215-037-161-00W2
		M83513 / 03-E03C	MM-213-031-161-00V1	M83513 / 03-F03C	MM-213-037-161-00V1
M83513 / 03-D01C	MM-213-025-161-00W1	M83513 / 03-E03N	MM-212-031-161-00V1	M83513 / 03-F03N	MM-212-037-161-00V1
M83513 / 03-D01N	MM-212-025-161-00W1	M83513 / 03-E03P	MM-215-031-161-00V1	M83513 / 03-F03P	MM-215-037-161-00V1
M83513 / 03-D01P	MM-215-025-161-00W1	M83513 / 03-E04C	MM-213-031-161-00V2	M83513 / 03-F04C	MM-213-037-161-00V2
M83513 / 03-D02C	MM-213-025-161-00W2	M83513 / 03-E04N	MM-212-031-161-00V2	M83513 / 03-F04N	MM-212-037-161-00V2
M83513 / 03-D02N	MM-212-025-161-00W2	M83513 / 03-E04P	MM-215-031-161-00V2	M83513 / 03-F04P	MM-215-037-161-00V2
M83513 / 03-D02P	MM-215-025-161-00W2	M83513 / 03-E05C	MM-213-031-143-0000	M83513 / 03-F05C	MM-213-037-143-0000
M83513 / 03-D03C	MM-213-025-161-00V1	M83513 / 03-E05N	MM-212-031-143-0000	M83513 / 03-F05N	MM-212-037-143-0000
				M83513 / 03-F05P	MM-215-037-143-0000
				M83513 / 03-F06C	MM-213-037-153-0000
				M83513 / 03-F06N	MM-212-037-153-0000
				M83513 / 03-F06P	MM-215-037-153-0000
				M83513 / 03-F07C	MM-213-037-145-0000
				M83513 / 03-F07N	MM-212-037-145-0000
				M83513 / 03-F07P	MM-215-037-145-0000

M83513 / 03 (continued)

M83513 / 03-F08C	MM-213-037-155-0000	M83513 / 03-G05P	MM-315-051-143-0000	M83513 / 03-H03N	MM-412-100-161-00V1
M83513 / 03-F08N	MM-212-037-155-0000	M83513 / 03-G06C	MM-313-051-153-0000	M83513 / 03-H03P	MM-415-100-161-00V1
M83513 / 03-F08P	MM-215-037-155-0000	M83513 / 03-G06N	MM-312-051-153-0000	M83513 / 03-H04C	MM-413-100-161-00V2
M83513 / 03-F09C	MM-213-037-161-00Y1	M83513 / 03-G06P	MM-315-051-153-0000	M83513 / 03-H04N	MM-412-100-161-00V2
M83513 / 03-F09N	MM-212-037-161-00Y1	M83513 / 03-G07C	MM-313-051-145-0000	M83513 / 03-H04P	MM-415-100-161-00V2
M83513 / 03-F09P	MM-215-037-161-00Y1	M83513 / 03-G07N	MM-312-051-145-0000	M83513 / 03-H05C	MM-413-100-143-0000
M83513 / 03-F10C	MM-213-037-161-00Y2	M83513 / 03-G07P	MM-315-051-145-0000	M83513 / 03-H05N	MM-412-100-143-0000
M83513 / 03-F10N	MM-212-037-161-00Y2	M83513 / 03-G08C	MM-313-051-155-0000	M83513 / 03-H05P	MM-415-100-143-0000
M83513 / 03-F10P	MM-215-037-161-00Y2	M83513 / 03-G08N	MM-312-051-155-0000	M83513 / 03-H06C	MM-413-100-153-0000
M83513 / 03-F11C	MM-213-037-161-00Y3	M83513 / 03-G08P	MM-315-051-155-0000	M83513 / 03-H06N	MM-412-100-153-0000
M83513 / 03-F11N	MM-212-037-161-00Y3	M83513 / 03-G09C	MM-313-051-161-00Y1	M83513 / 03-H06P	MM-415-100-153-0000
M83513 / 03-F11P	MM-215-037-161-00Y3	M83513 / 03-G09N	MM-312-051-161-00Y1	M83513 / 03-H07C	MM-413-100-145-0000
M83513 / 03-F12C	MM-213-037-161-00Y4	M83513 / 03-G09P	MM-315-051-161-00Y1	M83513 / 03-H07N	MM-412-100-145-0000
M83513 / 03-F12N	MM-212-037-161-00Y4	M83513 / 03-G10C	MM-313-051-161-00Y2	M83513 / 03-H07P	MM-415-100-145-0000
M83513 / 03-F12P	MM-215-037-161-00Y4	M83513 / 03-G10N	MM-312-051-161-00Y2	M83513 / 03-H08C	MM-413-100-155-0000
M83513 / 03-F13C	MM-213-037-161-00Y5	M83513 / 03-G10P	MM-315-051-161-00Y2	M83513 / 03-H08N	MM-412-100-155-0000
M83513 / 03-F13N	MM-212-037-161-00Y5	M83513 / 03-G11C	MM-313-051-161-00Y3	M83513 / 03-H08P	MM-415-100-155-0000
M83513 / 03-F13P	MM-215-037-161-00Y5	M83513 / 03-G11N	MM-312-051-161-00Y3	M83513 / 03-H09C	MM-413-100-161-00Y1
M83513 / 03-F14C	MM-213-037-161-00Y6	M83513 / 03-G11P	MM-315-051-161-00Y3	M83513 / 03-H09N	MM-412-100-161-00Y1
M83513 / 03-F14N	MM-212-037-161-00Y6	M83513 / 03-G12C	MM-313-051-161-00Y4	M83513 / 03-H09P	MM-415-100-161-00Y1
M83513 / 03-F14P	MM-215-037-161-00Y6	M83513 / 03-G12N	MM-312-051-161-00Y4	M83513 / 03-H10C	MM-413-100-161-00Y2
M83513 / 03-F15C	MM-213-037-161-00Y7	M83513 / 03-G12P	MM-315-051-161-00Y4	M83513 / 03-H10N	MM-412-100-161-00Y2
M83513 / 03-F15N	MM-212-037-161-00Y7	M83513 / 03-G13C	MM-313-051-161-00Y5	M83513 / 03-H10P	MM-415-100-161-00Y2
M83513 / 03-F15P	MM-215-037-161-00Y7	M83513 / 03-G13N	MM-312-051-161-00Y5	M83513 / 03-H11C	MM-413-100-161-00Y3
M83513 / 03-F16C	MM-213-037-161-00Y8	M83513 / 03-G13P	MM-315-051-161-00Y5	M83513 / 03-H11N	MM-412-100-161-00Y3
M83513 / 03-F16N	MM-212-037-161-00Y8	M83513 / 03-G14C	MM-313-051-161-00Y6	M83513 / 03-H11P	MM-415-100-161-00Y3
M83513 / 03-F16P	MM-215-037-161-00Y8	M83513 / 03-G14N	MM-312-051-161-00Y6	M83513 / 03-H12C	MM-413-100-161-00Y4
M83513 / 03-G01C	MM-313-051-161-00W1	M83513 / 03-G14P	MM-315-051-161-00Y6	M83513 / 03-H12N	MM-412-100-161-00Y4
M83513 / 03-G01N	MM-312-051-161-00W1	M83513 / 03-G15C	MM-313-051-161-00Y7	M83513 / 03-H12P	MM-415-100-161-00Y4
M83513 / 03-G01P	MM-315-051-161-00W1	M83513 / 03-G15N	MM-312-051-161-00Y7	M83513 / 03-H13C	MM-413-100-161-00Y5
M83513 / 03-G02C	MM-313-051-161-00W2	M83513 / 03-G15P	MM-315-051-161-00Y7	M83513 / 03-H13N	MM-412-100-161-00Y5
M83513 / 03-G02N	MM-312-051-161-00W2	M83513 / 03-G16C	MM-313-051-161-00Y8	M83513 / 03-H13P	MM-415-100-161-00Y5
M83513 / 03-G02P	MM-315-051-161-00W2	M83513 / 03-G16N	MM-312-051-161-00Y8	M83513 / 03-H14C	MM-413-100-161-00Y6
M83513 / 03-G03C	MM-313-051-161-00V1	M83513 / 03-G16P	MM-315-051-161-00Y8	M83513 / 03-H14N	MM-412-100-161-00Y6
M83513 / 03-G03N	MM-312-051-161-00V1	M83513 / 03-H01C	MM-413-100-161-00W1	M83513 / 03-H14P	MM-415-100-161-00Y6
M83513 / 03-G03P	MM-315-051-161-00V1	M83513 / 03-H01N	MM-412-100-161-00W1	M83513 / 03-H15C	MM-413-100-161-00Y7
M83513 / 03-G04C	MM-313-051-161-00V2	M83513 / 03-H01P	MM-415-100-161-00W1	M83513 / 03-H15N	MM-412-100-161-00Y7
M83513 / 03-G04N	MM-312-051-161-00V2	M83513 / 03-H02C	MM-413-100-161-00W2	M83513 / 03-H15P	MM-415-100-161-00Y7
M83513 / 03-G04P	MM-315-051-161-00V2	M83513 / 03-H02N	MM-412-100-161-00W2	M83513 / 03-H16C	MM-413-100-161-00Y8
M83513 / 03-G05C	MM-313-051-143-0000	M83513 / 03-H02P	MM-415-100-161-00W2	M83513 / 03-H16N	MM-412-100-161-00Y8
M83513 / 03-G05N	MM-312-051-143-0000	M83513 / 03-H03C	MM-413-100-161-00V1	M83513 / 03-H16P	MM-415-100-161-00Y8

M83513 / 04

M83513 / 04-A01C	MM-223-009-261-00W1-900	M83513 / 04-A05C	MM-223-009-243-0000-900	M83513 / 04-A09C	MM-223-009-261-00Y1-900
M83513 / 04-A01N	MM-222-009-261-00W1-900	M83513 / 04-A05N	MM-222-009-243-0000-900	M83513 / 04-A09N	MM-222-009-261-00Y1-900
M83513 / 04-A01P	MM-225-009-261-00W1-900	M83513 / 04-A05P	MM-225-009-243-0000-900	M83513 / 04-A09P	MM-225-009-261-00Y1-900
M83513 / 04-A02C	MM-223-009-261-00W2-900	M83513 / 04-A06C	MM-223-009-253-0000-900	M83513 / 04-A10C	MM-223-009-261-00Y2-900
M83513 / 04-A02N	MM-222-009-261-00W2-900	M83513 / 04-A06N	MM-222-009-253-0000-900	M83513 / 04-A10N	MM-222-009-261-00Y2-900
M83513 / 04-A02P	MM-225-009-261-00W2-900	M83513 / 04-A06P	MM-225-009-253-0000-900	M83513 / 04-A10P	MM-225-009-261-00Y2-900
M83513 / 04-A03C	MM-223-009-261-00V1-900	M83513 / 04-A07C	MM-223-009-245-0000-900	M83513 / 04-A11C	MM-223-009-261-00Y3-900
M83513 / 04-A03N	MM-222-009-261-00V1-900	M83513 / 04-A07N	MM-222-009-245-0000-900	M83513 / 04-A11N	MM-222-009-261-00Y3-900
M83513 / 04-A03P	MM-225-009-261-00V1-900	M83513 / 04-A07P	MM-225-009-245-0000-900	M83513 / 04-A11P	MM-225-009-261-00Y3-900
M83513 / 04-A04C	MM-223-009-261-00V2-900	M83513 / 04-A08C	MM-223-009-255-0000-900	M83513 / 04-A12C	MM-223-009-261-00Y4-900
M83513 / 04-A04N	MM-222-009-261-00V2-900	M83513 / 04-A08N	MM-222-009-255-0000-900	M83513 / 04-A12N	MM-222-009-261-00Y4-900
M83513 / 04-A04P	MM-225-009-261-00V2-900	M83513 / 04-A08P	MM-225-009-255-0000-900	M83513 / 04-A12P	MM-225-009-261-00Y4-900

M83513 / 04 (continued)

M83513 / 04-E03C	MM-223-031-261-00V1-900	M83513 / 04-F05C	MM-223-037-243-0000-900	M83513 / 04-G07C	MM-323-051-245-0000-900
M83513 / 04-E03N	MM-222-031-261-00V1-900	M83513 / 04-F05N	MM-222-037-243-0000-900	M83513 / 04-G07N	MM-322-051-245-0000-900
M83513 / 04-E03P	MM-225-031-261-00V1-900	M83513 / 04-F05P	MM-225-037-243-0000-900	M83513 / 04-G07P	MM-325-051-245-0000-900
M83513 / 04-E04C	MM-223-031-261-00V2-900	M83513 / 04-F06C	MM-223-037-253-0000-900	M83513 / 04-G08C	MM-323-051-255-0000-900
M83513 / 04-E04N	MM-222-031-261-00V2-900	M83513 / 04-F06N	MM-222-037-253-0000-900	M83513 / 04-G08N	MM-322-051-255-0000-900
M83513 / 04-E04P	MM-225-031-261-00V2-900	M83513 / 04-F06P	MM-225-037-253-0000-900	M83513 / 04-G08P	MM-325-051-255-0000-900
M83513 / 04-E05C	MM-223-031-243-0000-900	M83513 / 04-F07C	MM-223-037-245-0000-900	M83513 / 04-G09C	MM-323-051-261-00Y1-900
M83513 / 04-E05N	MM-222-031-243-0000-900	M83513 / 04-F07N	MM-222-037-245-0000-900	M83513 / 04-G09N	MM-322-051-261-00Y1-900
M83513 / 04-E05P	MM-225-031-243-0000-900	M83513 / 04-F07P	MM-225-037-245-0000-900	M83513 / 04-G09P	MM-325-051-261-00Y1-900
M83513 / 04-E06C	MM-223-031-253-0000-900	M83513 / 04-F08C	MM-223-037-255-0000-900	M83513 / 04-G10C	MM-323-051-261-00Y2-900
M83513 / 04-E06N	MM-222-031-253-0000-900	M83513 / 04-F08N	MM-222-037-255-0000-900	M83513 / 04-G10N	MM-322-051-261-00Y2-900
M83513 / 04-E06P	MM-225-031-253-0000-900	M83513 / 04-F08P	MM-225-037-255-0000-900	M83513 / 04-G10P	MM-325-051-261-00Y2-900
M83513 / 04-E07C	MM-223-031-245-0000-900	M83513 / 04-F09C	MM-223-037-261-00Y1-900	M83513 / 04-G11C	MM-323-051-261-00Y3-900
M83513 / 04-E07N	MM-222-031-245-0000-900	M83513 / 04-F09N	MM-222-037-261-00Y1-900	M83513 / 04-G11N	MM-322-051-261-00Y3-900
M83513 / 04-E07P	MM-225-031-245-0000-900	M83513 / 04-F09P	MM-225-037-261-00Y1-900	M83513 / 04-G11P	MM-325-051-261-00Y3-900
M83513 / 04-E08C	MM-223-031-255-0000-900	M83513 / 04-F10C	MM-223-037-261-00Y2-900	M83513 / 04-G12C	MM-323-051-261-00Y4-900
M83513 / 04-E08N	MM-222-031-255-0000-900	M83513 / 04-F10N	MM-222-037-261-00Y2-900	M83513 / 04-G12N	MM-322-051-261-00Y4-900
M83513 / 04-E08P	MM-225-031-255-0000-900	M83513 / 04-F10P	MM-225-037-261-00Y2-900	M83513 / 04-G12P	MM-325-051-261-00Y4-900
M83513 / 04-E09C	MM-223-031-261-00Y1-900	M83513 / 04-F11C	MM-223-037-261-00Y3-900	M83513 / 04-G13C	MM-323-051-261-00Y5-900
M83513 / 04-E09N	MM-222-031-261-00Y1-900	M83513 / 04-F11N	MM-222-037-261-00Y3-900	M83513 / 04-G13N	MM-322-051-261-00Y5-900
M83513 / 04-E09P	MM-225-031-261-00Y1-900	M83513 / 04-F11P	MM-225-037-261-00Y3-900	M83513 / 04-G13P	MM-325-051-261-00Y5-900
M83513 / 04-E10C	MM-223-031-261-00Y2-900	M83513 / 04-F12C	MM-223-037-261-00Y4-900	M83513 / 04-G14C	MM-323-051-261-00Y6-900
M83513 / 04-E10N	MM-222-031-261-00Y2-900	M83513 / 04-F12N	MM-222-037-261-00Y4-900	M83513 / 04-G14N	MM-322-051-261-00Y6-900
M83513 / 04-E10P	MM-225-031-261-00Y2-900	M83513 / 04-F12P	MM-225-037-261-00Y4-900	M83513 / 04-G14P	MM-325-051-261-00Y6-900
M83513 / 04-E11C	MM-223-031-261-00Y3-900	M83513 / 04-F13C	MM-223-037-261-00Y5-900	M83513 / 04-G15C	MM-323-051-261-00Y7-900
M83513 / 04-E11N	MM-222-031-261-00Y3-900	M83513 / 04-F13N	MM-222-037-261-00Y5-900	M83513 / 04-G15N	MM-322-051-261-00Y7-900
M83513 / 04-E11P	MM-225-031-261-00Y3-900	M83513 / 04-F13P	MM-225-037-261-00Y5-900	M83513 / 04-G15P	MM-325-051-261-00Y7-900
M83513 / 04-E12C	MM-223-031-261-00Y4-900	M83513 / 04-F14C	MM-223-037-261-00Y6-900	M83513 / 04-G16C	MM-323-051-261-00Y8-900
M83513 / 04-E12N	MM-222-031-261-00Y4-900	M83513 / 04-F14N	MM-222-037-261-00Y6-900	M83513 / 04-G16N	MM-322-051-261-00Y8-900
M83513 / 04-E12P	MM-225-031-261-00Y4-900	M83513 / 04-F14P	MM-225-037-261-00Y6-900	M83513 / 04-G16P	MM-325-051-261-00Y8-900
M83513 / 04-E13C	MM-223-031-261-00Y5-900	M83513 / 04-F15C	MM-223-037-261-00Y7-900		
M83513 / 04-E13N	MM-222-031-261-00Y5-900	M83513 / 04-F15N	MM-222-037-261-00Y7-900	M83513 / 04-H01C	MM-423-100-261-00W1-900
M83513 / 04-E13P	MM-225-031-261-00Y5-900	M83513 / 04-F15P	MM-225-037-261-00Y7-900	M83513 / 04-H01N	MM-422-100-261-00W1-900
M83513 / 04-E14C	MM-223-031-261-00Y6-900	M83513 / 04-F16C	MM-223-037-261-00Y8-900	M83513 / 04-H01P	MM-425-100-261-00W1-900
M83513 / 04-E14N	MM-222-031-261-00Y6-900	M83513 / 04-F16N	MM-222-037-261-00Y8-900	M83513 / 04-H02C	MM-423-100-261-00W2-900
M83513 / 04-E14P	MM-225-031-261-00Y6-900	M83513 / 04-F16P	MM-225-037-261-00Y8-900	M83513 / 04-H02N	MM-422-100-261-00W2-900
M83513 / 04-E15C	MM-223-031-261-00Y7-900			M83513 / 04-H02P	MM-425-100-261-00W2-900
M83513 / 04-E15N	MM-222-031-261-00Y7-900	M83513 / 04-G01C	MM-323-051-261-00W1-900	M83513 / 04-H03C	MM-423-100-261-00V1-900
M83513 / 04-E15P	MM-225-031-261-00Y7-900	M83513 / 04-G01N	MM-322-051-261-00W1-900	M83513 / 04-H03N	MM-422-100-261-00V1-900
M83513 / 04-E16C	MM-223-031-261-00Y8-900	M83513 / 04-G01P	MM-325-051-261-00W1-900	M83513 / 04-H03P	MM-425-100-261-00V1-900
M83513 / 04-E16N	MM-222-031-261-00Y8-900	M83513 / 04-G02C	MM-323-051-261-00W2-900	M83513 / 04-H04C	MM-423-100-261-00V2-900
M83513 / 04-E16P	MM-225-031-261-00Y8-900	M83513 / 04-G02N	MM-322-051-261-00W2-900	M83513 / 04-H04N	MM-422-100-261-00V2-900
		M83513 / 04-G02P	MM-325-051-261-00W2-900	M83513 / 04-H04P	MM-425-100-261-00V2-900
M83513 / 04-F01C	MM-223-037-261-00W1-900	M83513 / 04-G03C	MM-323-051-261-00V1-900	M83513 / 04-H05C	MM-423-100-243-0000-900
M83513 / 04-F01N	MM-222-037-261-00W1-900	M83513 / 04-G03N	MM-322-051-261-00V1-900	M83513 / 04-H05N	MM-422-100-243-0000-900
M83513 / 04-F01P	MM-225-037-261-00W1-900	M83513 / 04-G03P	MM-325-051-261-00V1-900	M83513 / 04-H05P	MM-425-100-243-0000-900
M83513 / 04-F02C	MM-223-037-261-00W2-900	M83513 / 04-G04C	MM-323-051-261-00V2-900	M83513 / 04-H06C	MM-423-100-253-0000-900
M83513 / 04-F02N	MM-222-037-261-00W2-900	M83513 / 04-G04N	MM-322-051-261-00V2-900	M83513 / 04-H06N	MM-422-100-253-0000-900
M83513 / 04-F02P	MM-225-037-261-00W2-900	M83513 / 04-G04P	MM-325-051-261-00V2-900	M83513 / 04-H06P	MM-425-100-253-0000-900
M83513 / 04-F03C	MM-223-037-261-00V1-900	M83513 / 04-G05C	MM-323-051-243-0000-900	M83513 / 04-H07C	MM-423-100-245-0000-900
M83513 / 04-F03N	MM-222-037-261-00V1-900	M83513 / 04-G05N	MM-322-051-243-0000-900	M83513 / 04-H07N	MM-422-100-245-0000-900
M83513 / 04-F03P	MM-225-037-261-00V1-900	M83513 / 04-G05P	MM-325-051-243-0000-900	M83513 / 04-H07P	MM-425-100-245-0000-900
M83513 / 04-F04C	MM-223-037-261-00V2-900	M83513 / 04-G06C	MM-323-051-253-0000-900	M83513 / 04-H08C	MM-423-100-255-0000-900
M83513 / 04-F04N	MM-222-037-261-00V2-900	M83513 / 04-G06N	MM-322-051-253-0000-900	M83513 / 04-H08N	MM-422-100-255-0000-900
M83513 / 04-F04P	MM-225-037-261-00V2-900	M83513 / 04-G06P	MM-325-051-253-0000-900	M83513 / 04-H08P	MM-425-100-255-0000-900

Military Cross Reference Chart

-- Continued from previous page



M83513 / 04 (continued)

M83513 / 04-H09C	MM-423-100-261-00Y1-900	M83513 / 04-H11P	MM-425-100-261-00Y3-900	M83513 / 04-H14N	MM-422-100-261-00Y6-900
M83513 / 04-H09N	MM-422-100-261-00Y1-900	M83513 / 04-H12C	MM-423-100-261-00Y4-900	M83513 / 04-H14P	MM-425-100-261-00Y6-900
M83513 / 04-H09P	MM-425-100-261-00Y1-900	M83513 / 04-H12N	MM-422-100-261-00Y4-900	M83513 / 04-H15C	MM-423-100-261-00Y7-900
M83513 / 04-H10C	MM-423-100-261-00Y2-900	M83513 / 04-H12P	MM-425-100-261-00Y4-900	M83513 / 04-H15N	MM-422-100-261-00Y7-900
M83513 / 04-H10N	MM-422-100-261-00Y2-900	M83513 / 04-H13C	MM-423-100-261-00Y5-900	M83513 / 04-H15P	MM-425-100-261-00Y7-900
M83513 / 04-H10P	MM-425-100-261-00Y2-900	M83513 / 04-H13N	MM-422-100-261-00Y5-900	M83513 / 04-H16C	MM-423-100-261-00Y8-900
M83513 / 04-H11C	MM-423-100-261-00Y3-900	M83513 / 04-H13P	MM-425-100-261-00Y5-900	M83513 / 04-H16N	MM-422-100-261-00Y8-900
M83513 / 04-H11N	MM-422-100-261-00Y3-900	M83513 / 04-H14C	MM-423-100-261-00Y6-900	M83513 / 04-H16P	MM-425-100-261-00Y8-900

M83513 / 05

M83513 / 05-02	00-000-000-000-4100
M83513 / 05-03	00-000-000-000-4200
M83513 / 05-05	00-000-000-000-4300
M83513 / 05-06	00-000-000-000-4400
M83513 / 05-07	00-000-000-000-2200
M83513 / 05-12	00-000-000-000-8100
M83513 / 05-13	00-000-000-000-8200
M83513 / 05-15	00-000-000-000-8300
M83513 / 05-16	00-000-000-000-8400
M83513 / 05-17	00-000-000-000-6200

M83513 / 06

M83513 / 06-A	MP-211-009-113-0000
M83513 / 06-B	MP-211-015-113-0000
M83513 / 06-C	MP-211-021-113-0000
M83513 / 06-D	MP-211-025-113-0000
M83513 / 06-E	MP-211-031-113-0000
M83513 / 06-F	MP-211-037-113-0000
M83513 / 06-G	MP-311-051-113-0000

M83513 / 07

M83513 / 07-A	MP-221-009-213-0000
M83513 / 07-B	MP-221-015-213-0000
M83513 / 07-C	MP-221-021-213-0000
M83513 / 07-D	MP-221-025-213-0000
M83513 / 07-E	MP-221-031-213-0000
M83513 / 07-F	MP-221-037-213-0000
M83513 / 07-G	MP-321-051-213-0000

M83513 / 08

M83513 / 08-A01	MP-211-009-161-00W1	M83513 / 08-C01	MP-211-021-161-00W1	M83513 / 08-E01	MP-211-031-161-00W1
M83513 / 08-A02	MP-211-009-161-00W2	M83513 / 08-C02	MP-211-021-161-00W2	M83513 / 08-E02	MP-211-031-161-00W2
M83513 / 08-A03	MP-211-009-161-00V1	M83513 / 08-C03	MP-211-021-161-00V1	M83513 / 08-E03	MP-211-031-161-00V1
M83513 / 08-A04	MP-211-009-161-00V2	M83513 / 08-C04	MP-211-021-161-00V2	M83513 / 08-E04	MP-211-031-161-00V2
M83513 / 08-A05	MP-211-009-143-0000	M83513 / 08-C05	MP-211-021-143-0000	M83513 / 08-E05	MP-211-031-143-0000
M83513 / 08-A06	MP-211-009-153-0000	M83513 / 08-C06	MP-211-021-153-0000	M83513 / 08-E06	MP-211-031-153-0000
M83513 / 08-A07	MP-211-009-145-0000	M83513 / 08-C07	MP-211-021-145-0000	M83513 / 08-E07	MP-211-031-145-0000
M83513 / 08-A08	MP-211-009-155-0000	M83513 / 08-C08	MP-211-021-155-0000	M83513 / 08-E08	MP-211-031-155-0000
M83513 / 08-A09	MP-211-009-161-00Y1	M83513 / 08-C09	MP-211-021-161-00Y1	M83513 / 08-E09	MP-211-031-161-00Y1
M83513 / 08-A10	MP-211-009-161-00Y2	M83513 / 08-C10	MP-211-021-161-00Y2	M83513 / 08-E10	MP-211-031-161-00Y2
M83513 / 08-A11	MP-211-009-161-00Y3	M83513 / 08-C11	MP-211-021-161-00Y3	M83513 / 08-E11	MP-211-031-161-00Y3
M83513 / 08-A12	MP-211-009-161-00Y4	M83513 / 08-C12	MP-211-021-161-00Y4	M83513 / 08-E12	MP-211-031-161-00Y4
M83513 / 08-A13	MP-211-009-161-00Y5	M83513 / 08-C13	MP-211-021-161-00Y5	M83513 / 08-E13	MP-211-031-161-00Y5
M83513 / 08-A14	MP-211-009-161-00Y6	M83513 / 08-C14	MP-211-021-161-00Y6	M83513 / 08-E14	MP-211-031-161-00Y6
M83513 / 08-A15	MP-211-009-161-00Y7	M83513 / 08-C15	MP-211-021-161-00Y7	M83513 / 08-E15	MP-211-031-161-00Y7
M83513 / 08-A16	MP-211-009-161-00Y8	M83513 / 08-C16	MP-211-021-161-00Y8	M83513 / 08-E16	MP-211-031-161-00Y8
M83513 / 08-B01	MP-211-015-161-00W1	M83513 / 08-D01	MP-211-025-161-00W1	M83513 / 08-F01	MP-211-037-161-00W1
M83513 / 08-B02	MP-211-015-161-00W2	M83513 / 08-D02	MP-211-025-161-00W2	M83513 / 08-F02	MP-211-037-161-00W2
M83513 / 08-B03	MP-211-015-161-00V1	M83513 / 08-D03	MP-211-025-161-00V1	M83513 / 08-F03	MP-211-037-161-00V1
M83513 / 08-B04	MP-211-015-161-00V2	M83513 / 08-D04	MP-211-025-161-00V2	M83513 / 08-F04	MP-211-037-161-00V2
M83513 / 08-B05	MP-211-015-143-0000	M83513 / 08-D05	MP-211-025-143-0000	M83513 / 08-F05	MP-211-037-143-0000
M83513 / 08-B06	MP-211-015-153-0000	M83513 / 08-D06	MP-211-025-153-0000	M83513 / 08-F06	MP-211-037-153-0000
M83513 / 08-B07	MP-211-015-145-0000	M83513 / 08-D07	MP-211-025-145-0000	M83513 / 08-F07	MP-211-037-145-0000
M83513 / 08-B08	MP-211-015-155-0000	M83513 / 08-D08	MP-211-025-155-0000	M83513 / 08-F08	MP-211-037-155-0000
M83513 / 08-B09	MP-211-015-161-00Y1	M83513 / 08-D09	MP-211-025-161-00Y1	M83513 / 08-F09	MP-211-037-161-00Y1
M83513 / 08-B10	MP-211-015-161-00Y2	M83513 / 08-D10	MP-211-025-161-00Y2	M83513 / 08-F10	MP-211-037-161-00Y2
M83513 / 08-B11	MP-211-015-161-00Y3	M83513 / 08-D11	MP-211-025-161-00Y3	M83513 / 08-F11	MP-211-037-161-00Y3
M83513 / 08-B12	MP-211-015-161-00Y4	M83513 / 08-D12	MP-211-025-161-00Y4	M83513 / 08-F12	MP-211-037-161-00Y4
M83513 / 08-B13	MP-211-015-161-00Y5	M83513 / 08-D13	MP-211-025-161-00Y5	M83513 / 08-F13	MP-211-037-161-00Y5
M83513 / 08-B14	MP-211-015-161-00Y6	M83513 / 08-D14	MP-211-025-161-00Y6	M83513 / 08-F14	MP-211-037-161-00Y6
M83513 / 08-B15	MP-211-015-161-00Y7	M83513 / 08-D15	MP-211-025-161-00Y7	M83513 / 08-F15	MP-211-037-161-00Y7
M83513 / 08-B16	MP-211-015-161-00Y8	M83513 / 08-D16	MP-211-025-161-00Y8	M83513 / 08-F16	MP-211-037-161-00Y8



Military Cross Reference Chart

-- Continued from previous page

M83513 / 08 (continued)

M83513 / 08-G01	MP-311-051-161-00W1	M83513 / 08-G07	MP-311-051-145-0000	M83513 / 08-G13	MP-311-051-161-00Y5
M83513 / 08-G02	MP-311-051-161-00W2	M83513 / 08-G08	MP-311-051-155-0000	M83513 / 08-G14	MP-311-051-161-00Y6
M83513 / 08-G03	MP-311-051-161-00V1	M83513 / 08-G09	MP-311-051-161-00Y1	M83513 / 08-G15	MP-311-051-161-00Y7
M83513 / 08-G04	MP-311-051-161-00V2	M83513 / 08-G10	MP-311-051-161-00Y2	M83513 / 08-G16	MP-311-051-161-00Y8
M83513 / 08-G05	MP-311-051-143-0000	M83513 / 08-G11	MP-311-051-161-00Y3		
M83513 / 08-G06	MP-311-051-153-0000	M83513 / 08-G12	MP-311-051-161-00Y4		

M83513 / 09

M83513 / 09-A01	MP-221-009-261-00W1	M83513 / 09-C07	MP-221-021-245-0000	M83513 / 09-E12	MP-221-031-261-00Y4
M83513 / 09-A02	MP-221-009-261-00W2	M83513 / 09-C08	MP-221-021-255-0000	M83513 / 09-E13	MP-221-031-261-00Y5
M83513 / 09-A03	MP-221-009-261-00V1	M83513 / 09-C09	MP-221-021-261-00Y1	M83513 / 09-E14	MP-221-031-261-00Y6
M83513 / 09-A04	MP-221-009-261-00V2	M83513 / 09-C10	MP-221-021-261-00Y2	M83513 / 09-E15	MP-221-031-261-00Y7
M83513 / 09-A05	MP-221-009-243-0000	M83513 / 09-C11	MP-221-021-261-00Y3	M83513 / 09-E16	MP-221-031-261-00Y8
M83513 / 09-A06	MP-221-009-253-0000	M83513 / 09-C12	MP-221-021-261-00Y4		
M83513 / 09-A07	MP-221-009-245-0000	M83513 / 09-C13	MP-221-021-261-00Y5	M83513 / 09-F01	MP-221-037-261-00W1
M83513 / 09-A08	MP-221-009-255-0000	M83513 / 09-C14	MP-221-021-261-00Y6	M83513 / 09-F02	MP-221-037-261-00W2
M83513 / 09-A09	MP-221-009-261-00Y1	M83513 / 09-C15	MP-221-021-261-00Y7	M83513 / 09-F03	MP-221-037-261-00V1
M83513 / 09-A10	MP-221-009-261-00Y2	M83513 / 09-C16	MP-221-021-261-00Y8	M83513 / 09-F04	MP-221-037-261-00V2
M83513 / 09-A11	MP-221-009-261-00Y3			M83513 / 09-F05	MP-221-037-243-0000
M83513 / 09-A12	MP-221-009-261-00Y4	M83513 / 09-D01	MP-221-025-261-00W1	M83513 / 09-F06	MP-221-037-253-0000
M83513 / 09-A13	MP-221-009-261-00Y5	M83513 / 09-D02	MP-221-025-261-00W2	M83513 / 09-F07	MP-221-037-245-0000
M83513 / 09-A14	MP-221-009-261-00Y6	M83513 / 09-D03	MP-221-025-261-00V1	M83513 / 09-F08	MP-221-037-255-0000
M83513 / 09-A15	MP-221-009-261-00Y7	M83513 / 09-D04	MP-221-025-261-00V2	M83513 / 09-F09	MP-221-037-261-00Y1
M83513 / 09-A16	MP-221-009-261-00Y8	M83513 / 09-D05	MP-221-025-261-00V2	M83513 / 09-F10	MP-221-037-261-00Y2
		M83513 / 09-D06	MP-221-025-243-0000	M83513 / 09-F11	MP-221-037-261-00Y3
M83513 / 09-B01	MP-221-015-261-00W1	M83513 / 09-D07	MP-221-025-253-0000	M83513 / 09-F12	MP-221-037-261-00Y4
M83513 / 09-B02	MP-221-015-261-00W2	M83513 / 09-D08	MP-221-025-245-0000	M83513 / 09-F13	MP-221-037-261-00Y5
M83513 / 09-B03	MP-221-015-261-00V1	M83513 / 09-D09	MP-221-025-255-0000	M83513 / 09-F14	MP-221-037-261-00Y6
M83513 / 09-B04	MP-221-015-261-00V2	M83513 / 09-D10	MP-221-025-261-00Y1	M83513 / 09-F15	MP-221-037-261-00Y7
M83513 / 09-B05	MP-221-015-243-0000	M83513 / 09-D11	MP-221-025-261-00Y2	M83513 / 09-F16	MP-221-037-261-00Y8
M83513 / 09-B06	MP-221-015-253-0000	M83513 / 09-D12	MP-221-025-261-00Y3		
M83513 / 09-B07	MP-221-015-245-0000	M83513 / 09-D13	MP-221-025-261-00Y4	M83513 / 09-G01	MP-321-051-261-00W1
M83513 / 09-B08	MP-221-015-255-0000	M83513 / 09-D14	MP-221-025-261-00Y5	M83513 / 09-G02	MP-321-051-261-00W2
M83513 / 09-B09	MP-221-015-261-00Y1	M83513 / 09-D15	MP-221-025-261-00Y6	M83513 / 09-G03	MP-321-051-261-00V1
M83513 / 09-B10	MP-221-015-261-00Y2	M83513 / 09-D16	MP-221-025-261-00Y7	M83513 / 09-G04	MP-321-051-261-00V2
M83513 / 09-B11	MP-221-015-261-00Y3		MP-221-025-261-00Y8	M83513 / 09-G05	MP-321-051-261-00V2
M83513 / 09-B12	MP-221-015-261-00Y4	M83513 / 09-E01	MP-221-031-261-00W1	M83513 / 09-G06	MP-321-051-243-0000
M83513 / 09-B13	MP-221-015-261-00Y5	M83513 / 09-E02	MP-221-031-261-00W2	M83513 / 09-G07	MP-321-051-253-0000
M83513 / 09-B14	MP-221-015-261-00Y6	M83513 / 09-E03	MP-221-031-261-00V1	M83513 / 09-G08	MP-321-051-245-0000
M83513 / 09-B15	MP-221-015-261-00Y7	M83513 / 09-E04	MP-221-031-261-00V2	M83513 / 09-G09	MP-321-051-261-00Y1
M83513 / 09-B16	MP-221-015-261-00Y8	M83513 / 09-E05	MP-221-031-261-00V2	M83513 / 09-G10	MP-321-051-261-00Y2
		M83513 / 09-E06	MP-221-031-243-0000	M83513 / 09-G11	MP-321-051-261-00Y3
M83513 / 09-C01	MP-221-021-261-00W1	M83513 / 09-E07	MP-221-031-253-0000	M83513 / 09-G12	MP-321-051-261-00Y4
M83513 / 09-C02	MP-221-021-261-00W2	M83513 / 09-E08	MP-221-031-245-0000	M83513 / 09-G13	MP-321-051-261-00Y5
M83513 / 09-C03	MP-221-021-261-00V1	M83513 / 09-E09	MP-221-031-255-0000	M83513 / 09-G14	MP-321-051-261-00Y6
M83513 / 09-C04	MP-221-021-261-00V2	M83513 / 09-E10	MP-221-031-261-00Y1	M83513 / 09-G15	MP-321-051-261-00Y7
M83513 / 09-C05	MP-221-021-243-0000	M83513 / 09-E11	MP-221-031-261-00Y2	M83513 / 09-G16	MP-321-051-261-00Y8
M83513 / 09-C06	MP-221-021-253-0000		MP-221-031-261-00Y3		

M83513 / 10

M83513 / 10-A01CN	MK-253-009-325-000S	M83513 / 10-A01NT	MK-252-009-325-000S-0B7	M83513 / 10-A02CN	MK-253-009-335-000S
M83513 / 10-A01CP	MK-253-009-325-220S	M83513 / 10-A01NW	MK-252-009-325-220S-0B7	M83513 / 10-A02CP	MK-253-009-335-220S
M83513 / 10-A01CT	MK-253-009-325-000S-0B7	M83513 / 10-A01PN	MK-255-009-325-000S	M83513 / 10-A02CT	MK-253-009-335-000S-0B7
M83513 / 10-A01CW	MK-253-009-325-220S-0B7	M83513 / 10-A01PP	MK-255-009-325-220S	M83513 / 10-A02CW	MK-253-009-335-220S-0B7
M83513 / 10-A01NN	MK-252-009-325-000S	M83513 / 10-A01PT	MK-255-009-325-000S-0B7	M83513 / 10-A02NN	MK-252-009-335-000S
M83513 / 10-A01NP	MK-252-009-325-220S	M83513 / 10-A01PW	MK-255-009-325-220S-0B7	M83513 / 10-A02NP	MK-252-009-335-220S

Military Cross Reference Chart

-- Continued from previous page



M83513 / 10 (continued)

M83513 / 10-A02NT	MK-252-009-335-000S-0B7	M83513 / 10-C01CN	MK-253-021-325-000S	M83513 / 10-D02NW	MK-252-025-335-220S-0B7
M83513 / 10-A02NW	MK-252-009-335-220S-0B7	M83513 / 10-C01CP	MK-253-021-325-220S	M83513 / 10-D02PN	MK-255-025-335-000S
M83513 / 10-A02PN	MK-255-009-335-000S	M83513 / 10-C01CT	MK-253-021-325-000S-0B7	M83513 / 10-D02PP	MK-255-025-335-220S
M83513 / 10-A02PP	MK-255-009-335-220S	M83513 / 10-C01CW	MK-253-021-325-220S-0B7	M83513 / 10-D02PT	MK-255-025-335-000S-0B7
M83513 / 10-A02PT	MK-255-009-335-000S-0B7	M83513 / 10-C01CN	MK-252-021-325-000S	M83513 / 10-D02PW	MK-255-025-335-220S-0B7
M83513 / 10-A02PW	MK-255-009-335-220S-0B7	M83513 / 10-C01NN	MK-252-021-325-000S	M83513 / 10-D03CN	MK-253-025-345-000S
M83513 / 10-A03CN	MK-253-009-345-000S	M83513 / 10-C01NT	MK-252-021-325-000S-0B7	M83513 / 10-D03CP	MK-253-025-345-220S
M83513 / 10-A03CP	MK-253-009-345-220S	M83513 / 10-C01NW	MK-252-021-325-220S-0B7	M83513 / 10-D03CT	MK-253-025-345-000S-0B7
M83513 / 10-A03CT	MK-253-009-345-000S-0B7	M83513 / 10-C01PN	MK-255-021-325-000S	M83513 / 10-D03CW	MK-253-025-345-220S-0B7
M83513 / 10-A03CW	MK-253-009-345-220S-0B7	M83513 / 10-C01PP	MK-255-021-325-220S	M83513 / 10-D03NN	MK-252-025-345-000S
M83513 / 10-A03NN	MK-252-009-345-000S	M83513 / 10-C01PT	MK-255-021-325-000S-0B7	M83513 / 10-D03NP	MK-252-025-345-220S
M83513 / 10-A03NP	MK-252-009-345-220S	M83513 / 10-C01PW	MK-255-021-325-220S-0B7	M83513 / 10-D03NT	MK-252-025-345-000S-0B7
M83513 / 10-A03NT	MK-252-009-345-000S-0B7	M83513 / 10-C02CN	MK-253-021-335-000S	M83513 / 10-D03NW	MK-252-025-345-220S-0B7
M83513 / 10-A03NW	MK-252-009-345-220S-0B7	M83513 / 10-C02CP	MK-253-021-335-220S	M83513 / 10-D03PN	MK-255-025-345-000S
M83513 / 10-A03PN	MK-255-009-345-000S	M83513 / 10-C02CT	MK-253-021-335-000S-0B7	M83513 / 10-D03PP	MK-255-025-345-220S
M83513 / 10-A03PP	MK-255-009-345-220S	M83513 / 10-C02CW	MK-253-021-335-220S-0B7	M83513 / 10-D03PT	MK-255-025-345-000S-0B7
M83513 / 10-A03PT	MK-255-009-345-000S-0B7	M83513 / 10-C02NN	MK-252-021-335-000S	M83513 / 10-D03PW	MK-255-025-345-220S-0B7
M83513 / 10-A03PW	MK-255-009-345-220S-0B7	M83513 / 10-C02NP	MK-252-021-335-220S		
		M83513 / 10-C02NT	MK-252-021-335-000S-0B7	M83513 / 10-E01CN	MK-253-031-325-000S
M83513 / 10-B01CN	MK-253-015-325-000S	M83513 / 10-C02NW	MK-252-021-335-220S-0B7	M83513 / 10-E01CP	MK-253-031-325-220S
M83513 / 10-B01CP	MK-253-015-325-220S	M83513 / 10-C02PN	MK-255-021-335-000S	M83513 / 10-E01CT	MK-253-031-325-000S-0B7
M83513 / 10-B01CT	MK-253-015-325-000S-0B7	M83513 / 10-C02PP	MK-255-021-335-220S	M83513 / 10-E01CW	MK-253-031-325-220S-0B7
M83513 / 10-B01CW	MK-253-015-325-220S-0B7	M83513 / 10-C02PT	MK-255-021-335-000S-0B7	M83513 / 10-E01NN	MK-252-031-325-000S
M83513 / 10-B01NN	MK-252-015-325-000S	M83513 / 10-C02PW	MK-255-021-335-220S-0B7	M83513 / 10-E01NP	MK-252-031-325-220S
M83513 / 10-B01NP	MK-252-015-325-220S	M83513 / 10-C03CN	MK-253-021-345-000S	M83513 / 10-E01NT	MK-252-031-325-000S-0B7
M83513 / 10-B01NT	MK-252-015-325-000S-0B7	M83513 / 10-C03CP	MK-253-021-345-220S	M83513 / 10-E01NW	MK-252-031-325-220S-0B7
M83513 / 10-B01NW	MK-252-015-325-220S-0B7	M83513 / 10-C03CT	MK-253-021-345-000S-0B7	M83513 / 10-E01PN	MK-255-031-325-000S
M83513 / 10-B01PN	MK-255-015-325-000S	M83513 / 10-C03CW	MK-253-021-345-220S-0B7	M83513 / 10-E01PP	MK-255-031-325-220S
M83513 / 10-B01PP	MK-255-015-325-220S	M83513 / 10-C03NN	MK-252-021-345-000S	M83513 / 10-E01PT	MK-255-031-325-000S-0B7
M83513 / 10-B01PT	MK-255-015-325-000S-0B7	M83513 / 10-C03NP	MK-252-021-345-220S	M83513 / 10-E01PW	MK-255-031-325-220S-0B7
M83513 / 10-B01PW	MK-255-015-325-220S-0B7	M83513 / 10-C03NT	MK-252-021-345-000S-0B7	M83513 / 10-E02CN	MK-253-031-335-000S
M83513 / 10-B02CN	MK-253-015-335-000S	M83513 / 10-C03NW	MK-252-021-345-220S-0B7	M83513 / 10-E02CP	MK-253-031-335-220S
M83513 / 10-B02CP	MK-253-015-335-220S	M83513 / 10-C03PN	MK-255-021-345-000S	M83513 / 10-E02CT	MK-253-031-335-000S-0B7
M83513 / 10-B02CT	MK-253-015-335-000S-0B7	M83513 / 10-C03PP	MK-255-021-345-220S	M83513 / 10-E02CW	MK-253-031-335-220S-0B7
M83513 / 10-B02CW	MK-253-015-335-220S-0B7	M83513 / 10-C03PT	MK-255-021-345-000S-0B7	M83513 / 10-E02NN	MK-252-031-335-000S
M83513 / 10-B02NN	MK-252-015-335-000S	M83513 / 10-C03PW	MK-255-021-345-220S-0B7	M83513 / 10-E02NP	MK-252-031-335-220S
M83513 / 10-B02NP	MK-252-015-335-220S			M83513 / 10-E02NT	MK-252-031-335-000S-0B7
M83513 / 10-B02NT	MK-252-015-335-000S-0B7	M83513 / 10-D01CN	MK-253-025-325-000S	M83513 / 10-E02NW	MK-252-031-335-220S-0B7
M83513 / 10-B02NW	MK-252-015-335-220S-0B7	M83513 / 10-D01CP	MK-253-025-325-220S	M83513 / 10-E02PN	MK-255-031-335-000S
M83513 / 10-B02PN	MK-255-015-335-000S	M83513 / 10-D01CT	MK-253-025-325-000S-0B7	M83513 / 10-E02PP	MK-255-031-335-220S
M83513 / 10-B02PP	MK-255-015-335-220S	M83513 / 10-D01CW	MK-253-025-325-220S-0B7	M83513 / 10-E02PT	MK-255-031-335-000S-0B7
M83513 / 10-B02PT	MK-255-015-335-000S-0B7	M83513 / 10-D01NN	MK-252-025-325-000S	M83513 / 10-E02PW	MK-255-031-335-220S-0B7
M83513 / 10-B02PW	MK-255-015-335-220S-0B7	M83513 / 10-D01NP	MK-252-025-325-220S	M83513 / 10-E03CN	MK-253-031-345-000S
M83513 / 10-B03CN	MK-253-015-345-000S	M83513 / 10-D01NT	MK-252-025-325-000S-0B7	M83513 / 10-E03CP	MK-253-031-345-220S
M83513 / 10-B03CP	MK-253-015-345-220S	M83513 / 10-D01NW	MK-252-025-325-220S-0B7	M83513 / 10-E03CT	MK-253-031-345-000S-0B7
M83513 / 10-B03CT	MK-253-015-345-000S-0B7	M83513 / 10-D01PN	MK-255-025-325-000S	M83513 / 10-E03CW	MK-253-031-345-220S-0B7
M83513 / 10-B03CW	MK-253-015-345-220S-0B7	M83513 / 10-D01PP	MK-255-025-325-220S	M83513 / 10-E03NN	MK-252-031-345-000S
M83513 / 10-B03NN	MK-252-015-345-000S	M83513 / 10-D01PT	MK-255-025-325-000S-0B7	M83513 / 10-E03NP	MK-252-031-345-220S
M83513 / 10-B03NP	MK-252-015-345-220S	M83513 / 10-D01PW	MK-255-025-325-220S-0B7	M83513 / 10-E03NT	MK-252-031-345-000S-0B7
M83513 / 10-B03NT	MK-252-015-345-000S-0B7	M83513 / 10-D02CN	MK-253-025-335-000S	M83513 / 10-E03NW	MK-252-031-345-220S-0B7
M83513 / 10-B03NW	MK-252-015-345-220S-0B7	M83513 / 10-D02CP	MK-253-025-335-220S	M83513 / 10-E03PN	MK-255-031-345-000S
M83513 / 10-B03PN	MK-255-015-345-000S	M83513 / 10-D02CT	MK-253-025-335-000S-0B7	M83513 / 10-E03PP	MK-255-031-345-220S
M83513 / 10-B03PP	MK-255-015-345-220S	M83513 / 10-D02CW	MK-253-025-335-220S-0B7	M83513 / 10-E03PT	MK-255-031-345-000S-0B7
M83513 / 10-B03PT	MK-255-015-345-000S-0B7	M83513 / 10-D02NN	MK-252-025-335-000S	M83513 / 10-E03PW	MK-255-031-345-220S-0B7
M83513 / 10-B03PW	MK-255-015-345-220S-0B7	M83513 / 10-D02NP	MK-252-025-335-220S		
		M83513 / 10-D02NT	MK-252-025-335-000S-0B7		

M83513 / 10 (continued)

M83513 / 10-F01CN	MK-253-037-325-000S	M83513 / 10-F02CN	MK-253-037-335-000S	M83513 / 10-F03CN	MK-253-037-345-000S
M83513 / 10-F01CP	MK-253-037-325-220S	M83513 / 10-F02CP	MK-253-037-335-220S	M83513 / 10-F03CP	MK-253-037-345-220S
M83513 / 10-F01CT	MK-253-037-325-000S-0B7	M83513 / 10-F02CT	MK-253-037-335-000S-0B7	M83513 / 10-F03CT	MK-253-037-345-000S-0B7
M83513 / 10-F01CW	MK-253-037-325-220S-0B7	M83513 / 10-F02CW	MK-253-037-335-220S-0B7	M83513 / 10-F03CW	MK-253-037-345-220S-0B7
M83513 / 10-F01NN	MK-252-037-325-000S	M83513 / 10-F02NN	MK-252-037-335-000S	M83513 / 10-F03NN	MK-252-037-345-000S
M83513 / 10-F01NP	MK-252-037-325-220S	M83513 / 10-F02NP	MK-252-037-335-220S	M83513 / 10-F03NP	MK-252-037-345-220S
M83513 / 10-F01NT	MK-252-037-325-000S-0B7	M83513 / 10-F02NT	MK-252-037-335-000S-0B7	M83513 / 10-F03NT	MK-252-037-345-000S-0B7
M83513 / 10-F01NW	MK-252-037-325-220S-0B7	M83513 / 10-F02NW	MK-252-037-335-220S-0B7	M83513 / 10-F03NW	MK-252-037-345-220S-0B7
M83513 / 10-F01PN	MK-255-037-325-000S	M83513 / 10-F02PN	MK-255-037-335-000S	M83513 / 10-F03PN	MK-255-037-345-000S
M83513 / 10-F01PP	MK-255-037-325-220S	M83513 / 10-F02PP	MK-255-037-335-220S	M83513 / 10-F03PP	MK-255-037-345-220S
M83513 / 10-F01PT	MK-255-037-325-000S-0B7	M83513 / 10-F02PT	MK-255-037-335-000S-0B7	M83513 / 10-F03PT	MK-255-037-345-000S-0B7
M83513 / 10-F01PW	MK-255-037-325-220S-0B7	M83513 / 10-F02PW	MK-255-037-335-220S-0B7	M83513 / 10-F03PW	MK-255-037-345-220S-0B7

M83513 / 11

M83513 / 11-G01CN	MK-353-051-325-000S	M83513 / 11-G02CN	MK-353-051-335-000S	M83513 / 11-G03CN	MK-353-051-345-000S
M83513 / 11-G01CP	MK-353-051-325-220S	M83513 / 11-G02CP	MK-353-051-335-220S	M83513 / 11-G03CP	MK-353-051-345-220S
M83513 / 11-G01CT	MK-353-051-325-000S-0B7	M83513 / 11-G02CT	MK-353-051-335-000S-0B7	M83513 / 11-G03CT	MK-353-051-345-000S-0B7
M83513 / 11-G01CW	MK-353-051-325-220S-0B7	M83513 / 11-G02CW	MK-353-051-335-220S-0B7	M83513 / 11-G03CW	MK-353-051-345-220S-0B7
M83513 / 11-G01NN	MK-352-051-325-000S	M83513 / 11-G02NN	MK-352-051-335-000S	M83513 / 11-G03NN	MK-352-051-345-000S
M83513 / 11-G01NP	MK-352-051-325-220S	M83513 / 11-G02NP	MK-352-051-335-220S	M83513 / 11-G03NP	MK-352-051-345-220S
M83513 / 11-G01NT	MK-352-051-325-000S-0B7	M83513 / 11-G02NT	MK-352-051-335-000S-0B7	M83513 / 11-G03NT	MK-352-051-345-000S-0B7
M83513 / 11-G01NW	MK-352-051-325-220S-0B7	M83513 / 11-G02NW	MK-352-051-335-220S-0B7	M83513 / 11-G03NW	MK-352-051-345-220S-0B7
M83513 / 11-G01PN	MK-355-051-325-000S	M83513 / 11-G02PN	MK-355-051-335-000S	M83513 / 11-G03PN	MK-355-051-345-000S
M83513 / 11-G01PP	MK-355-051-325-220S	M83513 / 11-G02PP	MK-355-051-335-220S	M83513 / 11-G03PP	MK-355-051-345-220S
M83513 / 11-G01PT	MK-355-051-325-000S-0B7	M83513 / 11-G02PT	MK-355-051-335-000S-0B7	M83513 / 11-G03PT	MK-355-051-345-000S-0B7
M83513 / 11-G01PW	MK-355-051-325-220S-0B7	M83513 / 11-G02PW	MK-355-051-335-220S-0B7	M83513 / 11-G03PW	MK-355-051-345-220S-0B7

M83513 / 12

M83513 / 12-H01CN	MK-453-100-325-000S-94P	M83513 / 12-H02CN	MK-453-100-335-000S-94P	M83513 / 12-H03CN	MK-453-100-345-000S-94P
M83513 / 12-H01CP	MK-453-100-325-620S-94P	M83513 / 12-H02CP	MK-453-100-335-620S-94P	M83513 / 12-H03CP	MK-453-100-345-620S-94P
M83513 / 12-H01CT	MK-453-100-325-000S-0BJ	M83513 / 12-H02CT	MK-453-100-335-000S-0BJ	M83513 / 12-H03CT	MK-453-100-345-000S-0BJ
M83513 / 12-H01CW	MK-453-100-325-620S-0BJ	M83513 / 12-H02CW	MK-453-100-335-620S-0BJ	M83513 / 12-H03CW	MK-453-100-345-620S-0BJ
M83513 / 12-H01NN	MK-452-100-325-000S-94P	M83513 / 12-H02NN	MK-452-100-335-000S-94P	M83513 / 12-H03NN	MK-452-100-345-000S-94P
M83513 / 12-H01NP	MK-452-100-325-620S-94P	M83513 / 12-H02NP	MK-452-100-335-620S-94P	M83513 / 12-H03NP	MK-452-100-345-620S-94P
M83513 / 12-H01NT	MK-452-100-325-000S-0BJ	M83513 / 12-H02NT	MK-452-100-335-000S-0BJ	M83513 / 12-H03NT	MK-452-100-345-000S-0BJ
M83513 / 12-H01NW	MK-452-100-325-620S-0BJ	M83513 / 12-H02NW	MK-452-100-335-620S-0BJ	M83513 / 12-H03NW	MK-452-100-345-620S-0BJ
M83513 / 12-H01PN	MK-455-100-325-000S-94P	M83513 / 12-H02PN	MK-455-100-335-000S-94P	M83513 / 12-H03PN	MK-455-100-345-000S-94P
M83513 / 12-H01PP	MK-455-100-325-620S-94P	M83513 / 12-H02PP	MK-455-100-335-620S-94P	M83513 / 12-H03PP	MK-455-100-345-620S-94P
M83513 / 12-H01PT	MK-455-100-325-000S-0BJ	M83513 / 12-H02PT	MK-455-100-335-000S-0BJ	M83513 / 12-H03PT	MK-455-100-345-000S-0BJ
M83513 / 12-H01PW	MK-455-100-325-620S-0BJ	M83513 / 12-H02PW	MK-455-100-335-620S-0BJ	M83513 / 12-H03PW	MK-455-100-345-620S-0BJ

M83513 / 13

M83513 / 13-A01CN	MK-263-009-435-000S-900	M83513 / 13-A02CN	MK-263-009-445-000S-900	M83513 / 13-A03CN	MK-263-009-455-000S-900
M83513 / 13-A01CP	MK-263-009-435-220S-900	M83513 / 13-A02CP	MK-263-009-445-220S-900	M83513 / 13-A03CP	MK-263-009-455-220S-900
M83513 / 13-A01CT	MK-263-009-435-000S-0B7	M83513 / 13-A02CT	MK-263-009-445-000S-0B7	M83513 / 13-A03CT	MK-263-009-455-000S-0B7
M83513 / 13-A01CW	MK-263-009-435-220S-0B7	M83513 / 13-A02CW	MK-263-009-445-220S-0B7	M83513 / 13-A03CW	MK-263-009-455-220S-0B7
M83513 / 13-A01NN	MK-262-009-435-000S-900	M83513 / 13-A02NN	MK-262-009-445-000S-900	M83513 / 13-A03NN	MK-262-009-455-000S-900
M83513 / 13-A01NP	MK-262-009-435-220S-900	M83513 / 13-A02NP	MK-262-009-445-220S-900	M83513 / 13-A03NP	MK-262-009-455-220S-900
M83513 / 13-A01NT	MK-262-009-435-000S-0B7	M83513 / 13-A02NT	MK-262-009-445-000S-0B7	M83513 / 13-A03NT	MK-262-009-455-000S-0B7
M83513 / 13-A01NW	MK-262-009-435-220S-0B7	M83513 / 13-A02NW	MK-262-009-445-220S-0B7	M83513 / 13-A03NW	MK-262-009-455-220S-0B7
M83513 / 13-A01PN	MK-265-009-435-000S-900	M83513 / 13-A02PN	MK-265-009-445-000S-900	M83513 / 13-A03PN	MK-265-009-455-000S-900
M83513 / 13-A01PP	MK-265-009-435-220S-900	M83513 / 13-A02PP	MK-265-009-445-220S-900	M83513 / 13-A03PP	MK-265-009-455-220S-900
M83513 / 13-A01PT	MK-265-009-435-000S-0B7	M83513 / 13-A02PT	MK-265-009-445-000S-0B7	M83513 / 13-A03PT	MK-265-009-455-000S-0B7
M83513 / 13-A01PW	MK-265-009-435-220S-0B7	M83513 / 13-A02PW	MK-265-009-445-220S-0B7	M83513 / 13-A03PW	MK-265-009-455-220S-0B7

M83513 / 13 (continued)

M83513 / 13-F02NT	MK-262-037-445-000S-0B7	M83513 / 13-F03CN	MK-263-037-455-000S-900	M83513 / 13-F03NT	MK-262-037-455-000S-0B7
M83513 / 13-F02NW	MK-262-037-445-220S-0B7	M83513 / 13-F03CP	MK-263-037-455-220S-900	M83513 / 13-F03NW	MK-262-037-455-220S-0B7
M83513 / 13-F02PN	MK-265-037-445-000S-900	M83513 / 13-F03CT	MK-263-037-455-000S-0B7	M83513 / 13-F03PN	MK-265-037-455-000S-900
M83513 / 13-F02PP	MK-265-037-445-220S-900	M83513 / 13-F03CW	MK-263-037-455-220S-0B7	M83513 / 13-F03PP	MK-265-037-455-220S-900
M83513 / 13-F02PT	MK-265-037-445-000S-0B7	M83513 / 13-F03NN	MK-262-037-455-000S-900	M83513 / 13-F03PT	MK-265-037-455-000S-0B7
M83513 / 13-F02PW	MK-265-037-445-220S-0B7	M83513 / 13-F03NP	MK-262-037-455-220S-900	M83513 / 13-F03PW	MK-265-037-455-220S-0B7

M83513 / 14

M83513 / 14-G01CN	MK-363-051-435-000S-900	M83513 / 14-G02CN	MK-363-051-445-000S-900	M83513 / 14-G03CN	MK-363-051-455-000S-900
M83513 / 14-G01CP	MK-363-051-435-220S-900	M83513 / 14-G02CP	MK-363-051-445-220S-900	M83513 / 14-G03CP	MK-363-051-455-220S-900
M83513 / 14-G01CT	MK-363-051-435-000S-0B7	M83513 / 14-G02CT	MK-363-051-445-000S-0B7	M83513 / 14-G03CT	MK-363-051-455-000S-0B7
M83513 / 14-G01CW	MK-363-051-435-220S-0B7	M83513 / 14-G02CW	MK-363-051-445-220S-0B7	M83513 / 14-G03CW	MK-363-051-455-220S-0B7
M83513 / 14-G01NN	MK-362-051-435-000S-900	M83513 / 14-G02NN	MK-362-051-445-000S-900	M83513 / 14-G03NN	MK-362-051-455-000S-900
M83513 / 14-G01NP	MK-362-051-435-220S-900	M83513 / 14-G02NP	MK-362-051-445-220S-900	M83513 / 14-G03NP	MK-362-051-455-220S-900
M83513 / 14-G01NT	MK-362-051-435-000S-0B7	M83513 / 14-G02NT	MK-362-051-445-000S-0B7	M83513 / 14-G03NT	MK-362-051-455-000S-0B7
M83513 / 14-G01NW	MK-362-051-435-220S-0B7	M83513 / 14-G02NW	MK-362-051-445-220S-0B7	M83513 / 14-G03NW	MK-362-051-455-220S-0B7
M83513 / 14-G01PN	MK-365-051-435-000S-900	M83513 / 14-G02PN	MK-365-051-445-000S-900	M83513 / 14-G03PN	MK-365-051-455-000S-900
M83513 / 14-G01PP	MK-365-051-435-220S-900	M83513 / 14-G02PP	MK-365-051-445-220S-900	M83513 / 14-G03PP	MK-365-051-455-220S-900
M83513 / 14-G01PT	MK-365-051-435-000S-0B7	M83513 / 14-G02PT	MK-365-051-445-000S-0B7	M83513 / 14-G03PT	MK-365-051-455-000S-0B7
M83513 / 14-G01PW	MK-365-051-435-220S-0B7	M83513 / 14-G02PW	MK-365-051-445-220S-0B7	M83513 / 14-G03PW	MK-365-051-455-220S-0B7

M83513 / 15

M83513 / 15-H01CN	MK-463-100-435-000S-900	M83513 / 15-H02CN	MK-463-100-445-000S-900	M83513 / 15-H03CN	MK-463-100-455-000S-900
M83513 / 15-H01CP	MK-463-100-435-620S-900	M83513 / 15-H02CP	MK-463-100-445-620S-900	M83513 / 15-H03CP	MK-463-100-455-620S-900
M83513 / 15-H01CT	MK-463-100-435-000S-0B7	M83513 / 15-H02CT	MK-463-100-445-000S-0B7	M83513 / 15-H03CT	MK-463-100-455-000S-0B7
M83513 / 15-H01CW	MK-463-100-435-620S-0B7	M83513 / 15-H02CW	MK-463-100-445-620S-0B7	M83513 / 15-H03CW	MK-463-100-455-620S-0B7
M83513 / 15-H01NN	MK-462-100-435-000S-900	M83513 / 15-H02NN	MK-462-100-445-000S-900	M83513 / 15-H03NN	MK-462-100-455-000S-900
M83513 / 15-H01NP	MK-462-100-435-620S-900	M83513 / 15-H02NP	MK-462-100-445-620S-900	M83513 / 15-H03NP	MK-462-100-455-620S-900
M83513 / 15-H01NT	MK-462-100-435-000S-0B7	M83513 / 15-H02NT	MK-462-100-445-000S-0B7	M83513 / 15-H03NT	MK-462-100-455-000S-0B7
M83513 / 15-H01NW	MK-462-100-435-620S-0B7	M83513 / 15-H02NW	MK-462-100-445-620S-0B7	M83513 / 15-H03NW	MK-462-100-455-620S-0B7
M83513 / 15-H01PN	MK-465-100-435-000S-900	M83513 / 15-H02PN	MK-465-100-445-000S-900	M83513 / 15-H03PN	MK-465-100-455-000S-900
M83513 / 15-H01PP	MK-465-100-435-620S-900	M83513 / 15-H02PP	MK-465-100-445-620S-900	M83513 / 15-H03PP	MK-465-100-455-620S-900
M83513 / 15-H01PT	MK-465-100-435-000S-0B7	M83513 / 15-H02PT	MK-465-100-445-000S-0B7	M83513 / 15-H03PT	MK-465-100-455-000S-0B7
M83513 / 15-H01PW	MK-465-100-435-620S-0B7	M83513 / 15-H02PW	MK-465-100-445-620S-0B7	M83513 / 15-H03PW	MK-465-100-455-620S-0B7

M83513 / 16

M83513 / 16-A01CN	MK-273-009-325-000R	M83513 / 16-A02NW	MK-272-009-335-220R-0B7	M83513 / 16-B01CN	MK-273-015-325-000R
M83513 / 16-A01CP	MK-273-009-325-220R	M83513 / 16-A02PN	MK-275-009-335-000R	M83513 / 16-B01CP	MK-273-015-325-220R
M83513 / 16-A01CT	MK-273-009-325-000R-0B7	M83513 / 16-A02PP	MK-275-009-335-220R	M83513 / 16-B01CT	MK-273-015-325-000R-0B7
M83513 / 16-A01CW	MK-273-009-325-220R-0B7	M83513 / 16-A02PT	MK-275-009-335-000R-0B7	M83513 / 16-B01CW	MK-273-015-325-220R-0B7
M83513 / 16-A01NN	MK-272-009-325-000R	M83513 / 16-A02PW	MK-275-009-335-220R-0B7	M83513 / 16-B01NN	MK-272-015-325-000R
M83513 / 16-A01NP	MK-272-009-325-220R	M83513 / 16-A03CN	MK-273-009-345-000R	M83513 / 16-B01NP	MK-272-015-325-220R
M83513 / 16-A01NT	MK-272-009-325-000R-0B7	M83513 / 16-A03CP	MK-273-009-345-220R	M83513 / 16-B01NT	MK-272-015-325-000R-0B7
M83513 / 16-A01NW	MK-272-009-325-220R-0B7	M83513 / 16-A03CT	MK-273-009-345-000R-0B7	M83513 / 16-B01NW	MK-272-015-325-220R-0B7
M83513 / 16-A01PN	MK-275-009-325-000R	M83513 / 16-A03CW	MK-273-009-345-220R-0B7	M83513 / 16-B01PN	MK-275-015-325-000R
M83513 / 16-A01PP	MK-275-009-325-220R	M83513 / 16-A03NN	MK-272-009-345-000R	M83513 / 16-B01PP	MK-275-015-325-220R
M83513 / 16-A01PT	MK-275-009-325-000R-0B7	M83513 / 16-A03NP	MK-272-009-345-220R	M83513 / 16-B01PT	MK-275-015-325-000R-0B7
M83513 / 16-A01PW	MK-275-009-325-220R-0B7	M83513 / 16-A03NT	MK-272-009-345-000R-0B7	M83513 / 16-B01PW	MK-275-015-325-220R-0B7
M83513 / 16-A02CN	MK-273-009-335-000R	M83513 / 16-A03NW	MK-272-009-345-220R-0B7	M83513 / 16-B02CN	MK-273-015-335-000R
M83513 / 16-A02CP	MK-273-009-335-220R	M83513 / 16-A03PN	MK-275-009-345-000R	M83513 / 16-B02CP	MK-273-015-335-220R
M83513 / 16-A02CT	MK-273-009-335-000R-0B7	M83513 / 16-A03PP	MK-275-009-345-220R	M83513 / 16-B02CT	MK-273-015-335-000R-0B7
M83513 / 16-A02CW	MK-273-009-335-220R-0B7	M83513 / 16-A03PT	MK-275-009-345-000R-0B7	M83513 / 16-B02CW	MK-273-015-335-220R-0B7
M83513 / 16-A02NN	MK-272-009-335-000R	M83513 / 16-A03PW	MK-275-009-345-220R-0B7	M83513 / 16-B02NN	MK-272-015-335-000R
M83513 / 16-A02NP	MK-272-009-335-220R			M83513 / 16-B02NP	MK-272-015-335-220R
M83513 / 16-A02NT	MK-272-009-335-000R-0B7			M83513 / 16-B02NT	MK-272-015-335-000R-0B7

Military Cross Reference Chart

-- Continued from previous page



M83513 / 16 (continued)

M83513 / 16-B02NW	MK-272-015-335-220R-0B7	M83513 / 16-D01CN	MK-273-025-325-000R	M83513 / 16-E02NW	MK-272-031-335-220R-0B7
M83513 / 16-B02PN	MK-275-015-335-000R	M83513 / 16-D01CP	MK-273-025-325-220R	M83513 / 16-E02PN	MK-275-031-335-000R
M83513 / 16-B02PP	MK-275-015-335-220R	M83513 / 16-D01CT	MK-273-025-325-000R-0B7	M83513 / 16-E02PP	MK-275-031-335-220R
M83513 / 16-B02PT	MK-275-015-335-000R-0B7	M83513 / 16-D01CW	MK-273-025-325-220R-0B7	M83513 / 16-E02PT	MK-275-031-335-000R-0B7
M83513 / 16-B02PW	MK-275-015-335-220R-0B7	M83513 / 16-D01NN	MK-272-025-325-000R	M83513 / 16-E02PW	MK-275-031-335-220R-0B7
M83513 / 16-B03CN	MK-273-015-345-000R	M83513 / 16-D01NP	MK-272-025-325-220R	M83513 / 16-E03CN	MK-273-031-345-000R
M83513 / 16-B03CP	MK-273-015-345-220R	M83513 / 16-D01NT	MK-272-025-325-000R-0B7	M83513 / 16-E03CP	MK-273-031-345-220R
M83513 / 16-B03CT	MK-273-015-345-000R-0B7	M83513 / 16-D01NW	MK-272-025-325-220R-0B7	M83513 / 16-E03CT	MK-273-031-345-000R-0B7
M83513 / 16-B03CW	MK-273-015-345-220R-0B7	M83513 / 16-D01PN	MK-275-025-325-000R	M83513 / 16-E03CW	MK-273-031-345-220R-0B7
M83513 / 16-B03NN	MK-272-015-345-000R	M83513 / 16-D01PP	MK-275-025-325-220R	M83513 / 16-E03NN	MK-272-031-345-000R
M83513 / 16-B03NP	MK-272-015-345-220R	M83513 / 16-D01PT	MK-275-025-325-000R-0B7	M83513 / 16-E03NP	MK-272-031-345-220R
M83513 / 16-B03NT	MK-272-015-345-000R-0B7	M83513 / 16-D01PW	MK-275-025-325-220R-0B7	M83513 / 16-E03NT	MK-272-031-345-000R-0B7
M83513 / 16-B03NW	MK-272-015-345-220R-0B7	M83513 / 16-D02CN	MK-275-025-335-000R	M83513 / 16-E03NW	MK-272-031-345-220R-0B7
M83513 / 16-B03PN	MK-275-015-345-000R	M83513 / 16-D02CP	MK-273-025-335-220R	M83513 / 16-E03PN	MK-275-031-345-000R
M83513 / 16-B03PP	MK-275-015-345-220R	M83513 / 16-D02CT	MK-273-025-335-000R-0B7	M83513 / 16-E03PP	MK-275-031-345-220R
M83513 / 16-B03PT	MK-275-015-345-000R-0B7	M83513 / 16-D02CW	MK-273-025-335-220R-0B7	M83513 / 16-E03PT	MK-275-031-345-000R-0B7
M83513 / 16-B03PW	MK-275-015-345-220R-0B7	M83513 / 16-D02NN	MK-272-025-335-000R	M83513 / 16-E03PW	MK-275-031-345-220R-0B7
		M83513 / 16-D02NP	MK-272-025-335-220R		
M83513 / 16-C01CN	MK-273-021-325-000R	M83513 / 16-D02NT	MK-272-025-335-000R-0B7	M83513 / 16-F01CN	MK-273-037-325-000R
M83513 / 16-C01CP	MK-273-021-325-220R	M83513 / 16-D02NW	MK-272-025-335-220R-0B7	M83513 / 16-F01CP	MK-273-037-325-220R
M83513 / 16-C01CT	MK-273-021-325-000R-0B7	M83513 / 16-D02PN	MK-275-025-335-000R	M83513 / 16-F01CT	MK-273-037-325-000R-0B7
M83513 / 16-C01CW	MK-273-021-325-220R-0B7	M83513 / 16-D02PP	MK-275-025-335-220R	M83513 / 16-F01CW	MK-273-037-325-220R-0B7
M83513 / 16-C01NN	MK-272-021-325-000R	M83513 / 16-D02PT	MK-275-025-335-000R-0B7	M83513 / 16-F01CW	MK-273-037-325-220R-0B7
M83513 / 16-C01NP	MK-272-021-325-220R	M83513 / 16-D02PW	MK-275-025-335-220R-0B7	M83513 / 16-F01NN	MK-272-037-325-000R
M83513 / 16-C01NT	MK-272-021-325-000R-0B7	M83513 / 16-D03CN	MK-273-025-345-000R	M83513 / 16-F01NP	MK-272-037-325-220R-0B7
M83513 / 16-C01NW	MK-272-021-325-220R-0B7	M83513 / 16-D03CP	MK-273-025-345-220R	M83513 / 16-F01NT	MK-272-037-325-000R-0B7
M83513 / 16-C01PN	MK-275-021-325-000R	M83513 / 16-D03CT	MK-273-025-345-000R-0B7	M83513 / 16-F01NW	MK-272-037-325-220R-0B7
M83513 / 16-C01PP	MK-275-021-325-220R	M83513 / 16-D03CW	MK-273-025-345-220R-0B7	M83513 / 16-F01PN	MK-275-037-325-000R
M83513 / 16-C01PT	MK-275-021-325-000R-0B7	M83513 / 16-D03NN	MK-272-025-345-000R	M83513 / 16-F01PP	MK-275-037-325-220R
M83513 / 16-C01PW	MK-275-021-325-220R-0B7	M83513 / 16-D03NP	MK-272-025-345-220R	M83513 / 16-F01PT	MK-275-037-325-000R-0B7
M83513 / 16-C02CN	MK-273-021-335-000R	M83513 / 16-D03NT	MK-272-025-345-000R-0B7	M83513 / 16-F01PW	MK-275-037-325-220R-0B7
M83513 / 16-C02CP	MK-273-021-335-220R	M83513 / 16-D03NW	MK-272-025-345-220R-0B7	M83513 / 16-F02CN	MK-273-037-335-000R
M83513 / 16-C02CT	MK-273-021-335-000R-0B7	M83513 / 16-D03PN	MK-275-025-345-000R	M83513 / 16-F02CP	MK-273-037-335-220R
M83513 / 16-C02CW	MK-273-021-335-220R-0B7	M83513 / 16-D03PP	MK-275-025-345-220R	M83513 / 16-F02CT	MK-273-037-335-000R-0B7
M83513 / 16-C02NN	MK-272-021-335-000R	M83513 / 16-D03PT	MK-275-025-345-000R-0B7	M83513 / 16-F02CW	MK-273-037-335-220R-0B7
M83513 / 16-C02NP	MK-272-021-335-220R	M83513 / 16-D03PW	MK-275-025-345-220R-0B7	M83513 / 16-F02NN	MK-272-037-335-000R
M83513 / 16-C02NT	MK-272-021-335-000R-0B7			M83513 / 16-F02NP	MK-272-037-335-220R
M83513 / 16-C02NW	MK-272-021-335-220R-0B7	M83513 / 16-E01CN	MK-273-031-325-000R	M83513 / 16-F02NT	MK-272-037-335-000R-0B7
M83513 / 16-C02PN	MK-275-021-335-000R	M83513 / 16-E01CP	MK-273-031-325-220R	M83513 / 16-F02NW	MK-272-037-335-220R-0B7
M83513 / 16-C02PP	MK-275-021-335-220R	M83513 / 16-E01CT	MK-273-031-325-000R-0B7	M83513 / 16-F02PN	MK-275-037-335-000R
M83513 / 16-C02PT	MK-275-021-335-000R-0B7	M83513 / 16-E01CW	MK-273-031-325-220R-0B7	M83513 / 16-F02PP	MK-275-037-335-220R
M83513 / 16-C02PW	MK-275-021-335-220R-0B7	M83513 / 16-E01NN	MK-272-031-325-000R	M83513 / 16-F02PT	MK-275-037-335-000R-0B7
M83513 / 16-C03CN	MK-273-021-345-000R	M83513 / 16-E01NP	MK-272-031-325-220R	M83513 / 16-F02PW	MK-275-037-335-220R-0B7
M83513 / 16-C03CP	MK-273-021-345-220R	M83513 / 16-E01NT	MK-272-031-325-000R-0B7	M83513 / 16-F03CN	MK-273-037-345-000R
M83513 / 16-C03CT	MK-273-021-345-000R-0B7	M83513 / 16-E01NW	MK-272-031-325-220R-0B7	M83513 / 16-F03CP	MK-273-037-345-220R
M83513 / 16-C03CW	MK-273-021-345-220R-0B7	M83513 / 16-E01PN	MK-275-031-325-000R	M83513 / 16-F03CT	MK-273-037-345-000R-0B7
M83513 / 16-C03NN	MK-272-021-345-000R	M83513 / 16-E01PP	MK-275-031-325-220R	M83513 / 16-F03CW	MK-273-037-345-220R-0B7
M83513 / 16-C03NP	MK-272-021-345-220R	M83513 / 16-E01PT	MK-275-031-325-000R-0B7	M83513 / 16-F03NN	MK-272-037-345-000R
M83513 / 16-C03NT	MK-272-021-345-000R-0B7	M83513 / 16-E01PW	MK-275-031-325-220R-0B7	M83513 / 16-F03NP	MK-272-037-345-220R
M83513 / 16-C03NW	MK-272-021-345-220R-0B7	M83513 / 16-E02CN	MK-273-031-335-000R	M83513 / 16-F03NT	MK-272-037-345-000R-0B7
M83513 / 16-C03PN	MK-275-021-345-000R	M83513 / 16-E02CP	MK-273-031-335-220R	M83513 / 16-F03NW	MK-272-037-345-220R-0B7
M83513 / 16-C03PP	MK-275-021-345-220R	M83513 / 16-E02CT	MK-273-031-335-000R-0B7	M83513 / 16-F03PN	MK-275-037-345-000R
M83513 / 16-C03PT	MK-275-021-345-000R-0B7	M83513 / 16-E02CW	MK-273-031-335-220R-0B7	M83513 / 16-F03PP	MK-275-037-345-220R
M83513 / 16-C03PW	MK-275-021-345-220R-0B7	M83513 / 16-E02NN	MK-272-031-335-000R	M83513 / 16-F03PT	MK-275-037-345-000R-0B7
		M83513 / 16-E02NP	MK-272-031-335-220R	M83513 / 16-F03PW	MK-275-037-345-220R-0B7
		M83513 / 16-E02NT	MK-272-031-335-000R-0B7		

M83513 / 17

M83513 / 17-G01CN	MK-373-051-325-000R	M83513 / 17-G02CN	MK-373-051-335-000R	M83513 / 17-G03CN	MK-373-051-345-000R
M83513 / 17-G01CP	MK-373-051-325-220R	M83513 / 17-G02CP	MK-373-051-335-220R	M83513 / 17-G03CP	MK-373-051-345-220R
M83513 / 17-G01CT	MK-373-051-325-000R-0B7	M83513 / 17-G02CT	MK-373-051-335-000R-0B7	M83513 / 17-G03CT	MK-373-051-345-000R-0B7
M83513 / 17-G01CW	MK-373-051-325-220R-0B7	M83513 / 17-G02CW	MK-373-051-335-220R-0B7	M83513 / 17-G03CW	MK-373-051-345-220R-0B7
M83513 / 17-G01NN	MK-372-051-325-000R	M83513 / 17-G02NN	MK-372-051-335-000R	M83513 / 17-G03NN	MK-372-051-345-000R
M83513 / 17-G01NP	MK-372-051-325-220R	M83513 / 17-G02NP	MK-372-051-335-220R	M83513 / 17-G03NP	MK-372-051-345-220R
M83513 / 17-G01NT	MK-372-051-325-000R-0B7	M83513 / 17-G02NT	MK-372-051-335-000R-0B7	M83513 / 17-G03NT	MK-372-051-345-000R-0B7
M83513 / 17-G01NW	MK-372-051-325-220R-0B7	M83513 / 17-G02NW	MK-372-051-335-220R-0B7	M83513 / 17-G03NW	MK-372-051-345-220R-0B7
M83513 / 17-G01PN	MK-375-051-325-000R	M83513 / 17-G02PN	MK-375-051-335-000R	M83513 / 17-G03PN	MK-375-051-345-000R
M83513 / 17-G01PP	MK-375-051-325-220R	M83513 / 17-G02PP	MK-375-051-335-220R	M83513 / 17-G03PP	MK-375-051-345-220R
M83513 / 17-G01PT	MK-375-051-325-000R-0B7	M83513 / 17-G02PT	MK-375-051-335-000R-0B7	M83513 / 17-G03PT	MK-375-051-345-000R-0B7
M83513 / 17-G01PW	MK-375-051-325-220R-0B7	M83513 / 17-G02PW	MK-375-051-335-220R-0B7	M83513 / 17-G03PW	MK-375-051-345-220R-0B7

M83513 / 18

M83513 / 18-H01CN	MK-473-100-325-000R-05K	M83513 / 18-H02CN	MK-473-100-335-000R-05K	M83513 / 18-H03CN	MK-473-100-345-000R-05K
M83513 / 18-H01CP	MK-473-100-325-620R-05K	M83513 / 18-H02CP	MK-473-100-335-620R-05K	M83513 / 18-H03CP	MK-473-100-345-620R-05K
M83513 / 18-H01CT	MK-473-100-325-000R-0BJ	M83513 / 18-H02CT	MK-473-100-335-000R-0BJ	M83513 / 18-H03CT	MK-473-100-345-000R-0BJ
M83513 / 18-H01CW	MK-473-100-325-620R-0BJ	M83513 / 18-H02CW	MK-473-100-335-620R-0BJ	M83513 / 18-H03CW	MK-473-100-345-620R-0BJ
M83513 / 18-H01NN	MK-472-100-325-000R-05K	M83513 / 18-H02NN	MK-472-100-335-000R-05K	M83513 / 18-H03NN	MK-472-100-345-000R-05K
M83513 / 18-H01NP	MK-472-100-325-620R-05K	M83513 / 18-H02NP	MK-472-100-335-620R-05K	M83513 / 18-H03NP	MK-472-100-345-620R-05K
M83513 / 18-H01NT	MK-472-100-325-000R-0BJ	M83513 / 18-H02NT	MK-472-100-335-000R-0BJ	M83513 / 18-H03NT	MK-472-100-345-000R-0BJ
M83513 / 18-H01NW	MK-472-100-325-620R-0BJ	M83513 / 18-H02NW	MK-472-100-335-620R-0BJ	M83513 / 18-H03NW	MK-472-100-345-620R-0BJ
M83513 / 18-H01PN	MK-475-100-325-000R-05K	M83513 / 18-H02PN	MK-475-100-335-000R-05K	M83513 / 18-H03PN	MK-475-100-345-000R-05K
M83513 / 18-H01PP	MK-475-100-325-620R-05K	M83513 / 18-H02PP	MK-475-100-335-620R-05K	M83513 / 18-H03PP	MK-475-100-345-620R-05K
M83513 / 18-H01PT	MK-475-100-325-000R-0BJ	M83513 / 18-H02PT	MK-475-100-335-000R-0BJ	M83513 / 18-H03PT	MK-475-100-345-000R-0BJ
M83513 / 18-H01PW	MK-475-100-325-620R-0BJ	M83513 / 18-H02PW	MK-475-100-335-620R-0BJ	M83513 / 18-H03PW	MK-475-100-345-620R-0BJ

M83513 / 19

M83513 / 19-A01CN	MK-283-009-435-000R-900	M83513 / 19-A03NN	MK-282-009-455-000R-900	M83513 / 19-B02NW	MK-282-015-445-220R-0B7
M83513 / 19-A01CP	MK-283-009-435-220R-900	M83513 / 19-A03NP	MK-282-009-455-220R-900	M83513 / 19-B02PN	MK-285-015-445-000R-900
M83513 / 19-A01CT	MK-283-009-435-000R-0B7	M83513 / 19-A03NT	MK-282-009-455-000R-0B7	M83513 / 19-B02PP	MK-285-015-445-220R-900
M83513 / 19-A01CW	MK-283-009-435-220R-0B7	M83513 / 19-A03NW	MK-282-009-455-220R-0B7	M83513 / 19-B02PT	MK-285-015-445-000R-0B7
M83513 / 19-A01NN	MK-282-009-435-000R-900	M83513 / 19-A03PN	MK-285-009-455-000R-900	M83513 / 19-B02PW	MK-285-015-445-220R-0B7
M83513 / 19-A01NP	MK-282-009-435-220R-900	M83513 / 19-A03PP	MK-285-009-455-220R-900	M83513 / 19-B03CN	MK-283-015-455-000R-900
M83513 / 19-A01NT	MK-282-009-435-000R-0B7	M83513 / 19-A03PT	MK-285-009-455-000R-0B7	M83513 / 19-B03CP	MK-283-015-455-220R-900
M83513 / 19-A01NW	MK-282-009-435-220R-0B7	M83513 / 19-A03PW	MK-285-009-455-220R-0B7	M83513 / 19-B03CT	MK-283-015-455-000R-0B7
M83513 / 19-A01PN	MK-285-009-435-000R-900			M83513 / 19-B03CW	MK-283-015-455-220R-0B7
M83513 / 19-A01PP	MK-285-009-435-220R-900	M83513 / 19-B01CN	MK-283-015-435-000R-900	M83513 / 19-B03NN	MK-282-015-455-000R-900
M83513 / 19-A01PT	MK-285-009-435-000R-0B7	M83513 / 19-B01CP	MK-283-015-435-220R-900	M83513 / 19-B03NP	MK-282-015-455-220R-900
M83513 / 19-A01PW	MK-285-009-435-220R-0B7	M83513 / 19-B01CT	MK-283-015-435-000R-0B7	M83513 / 19-B03NT	MK-282-015-455-000R-0B7
M83513 / 19-A02CN	MK-283-009-445-000R-900	M83513 / 19-B01CW	MK-283-015-435-220R-0B7	M83513 / 19-B03NW	MK-282-015-455-220R-0B7
M83513 / 19-A02CP	MK-283-009-445-220R-900	M83513 / 19-B01NN	MK-282-015-435-000R-900	M83513 / 19-B03PN	MK-285-015-455-000R-900
M83513 / 19-A02CT	MK-283-009-445-000R-0B7	M83513 / 19-B01NP	MK-282-015-435-220R-900	M83513 / 19-B03PP	MK-285-015-455-220R-900
M83513 / 19-A02CW	MK-283-009-445-220R-0B7	M83513 / 19-B01NT	MK-282-015-435-000R-0B7	M83513 / 19-B03PT	MK-285-015-455-000R-0B7
M83513 / 19-A02NN	MK-282-009-445-000R-900	M83513 / 19-B01NW	MK-282-015-435-220R-0B7	M83513 / 19-B03PW	MK-285-015-455-220R-0B7
M83513 / 19-A02NP	MK-282-009-445-220R-900	M83513 / 19-B01PN	MK-285-015-435-000R-900		
M83513 / 19-A02NT	MK-282-009-445-000R-0B7	M83513 / 19-B01PP	MK-285-015-435-220R-900	M83513 / 19-C01CN	MK-283-021-435-000R-900
M83513 / 19-A02NW	MK-282-009-445-220R-0B7	M83513 / 19-B01PT	MK-285-015-435-000R-0B7	M83513 / 19-C01CP	MK-283-021-435-220R-900
M83513 / 19-A02PN	MK-285-009-445-000R-900	M83513 / 19-B01PW	MK-285-015-435-220R-0B7	M83513 / 19-C01CT	MK-283-021-435-000R-0B7
M83513 / 19-A02PP	MK-285-009-445-220R-900	M83513 / 19-B02CN	MK-283-015-445-000R-900	M83513 / 19-C01CW	MK-283-021-435-220R-0B7
M83513 / 19-A02PT	MK-285-009-445-000R-0B7	M83513 / 19-B02CP	MK-283-015-445-220R-900	M83513 / 19-C01NN	MK-282-021-435-000R-900
M83513 / 19-A02PW	MK-285-009-445-220R-0B7	M83513 / 19-B02CT	MK-283-015-445-000R-0B7	M83513 / 19-C01NP	MK-282-021-435-220R-900
M83513 / 19-A03CN	MK-283-009-455-000R-900	M83513 / 19-B02CW	MK-283-015-445-220R-0B7	M83513 / 19-C01NT	MK-282-021-435-000R-0B7
M83513 / 19-A03CP	MK-283-009-455-220R-900	M83513 / 19-B02NN	MK-282-015-445-000R-900	M83513 / 19-C01NW	MK-282-021-435-220R-0B7
M83513 / 19-A03CT	MK-283-009-455-000R-0B7	M83513 / 19-B02NP	MK-282-015-445-220R-900	M83513 / 19-C01PN	MK-285-021-435-000R-900
M83513 / 19-A03CW	MK-283-009-455-220R-0B7	M83513 / 19-B02NT	MK-282-015-445-000R-0B7	M83513 / 19-C01PP	MK-285-021-435-220R-900

Military Cross Reference Chart

-- Continued from previous page



M83513 / 19 (continued)

M83513 / 19-C01PT	MK-285-021-435-000R-0B7	M83513 / 19-D02NW	MK-282-025-445-220R-0B7	M83513 / 19-E03NN	MK-282-031-455-000R-900
M83513 / 19-C01PW	MK-285-021-435-220R-0B7	M83513 / 19-D02PN	MK-285-025-445-000R-900	M83513 / 19-E03NP	MK-282-031-455-220R-900
M83513 / 19-C02CN	MK-283-021-445-000R-900	M83513 / 19-D02PP	MK-285-025-445-220R-900	M83513 / 19-E03NT	MK-282-031-455-000R-0B7
M83513 / 19-C02CP	MK-283-021-445-220R-900	M83513 / 19-D02PT	MK-285-025-445-000R-0B7	M83513 / 19-E03NW	MK-282-031-455-220R-0B7
M83513 / 19-C02CT	MK-283-021-445-000R-0B7	M83513 / 19-D02PW	MK-285-025-445-220R-0B7	M83513 / 19-E03PN	MK-285-031-455-000R-900
M83513 / 19-C02CW	MK-283-021-445-220R-0B7	M83513 / 19-D03CN	MK-283-025-455-000R-900	M83513 / 19-E03PP	MK-285-031-455-220R-900
M83513 / 19-C02NN	MK-282-021-445-000R-900	M83513 / 19-D03CP	MK-283-025-455-220R-900	M83513 / 19-E03PT	MK-285-031-455-000R-0B7
M83513 / 19-C02NP	MK-282-021-445-220R-900	M83513 / 19-D03CT	MK-283-025-455-000R-0B7	M83513 / 19-E03PW	MK-285-031-455-220R-0B7
M83513 / 19-C02NT	MK-282-021-445-000R-0B7	M83513 / 19-D03CW	MK-283-025-455-220R-0B7		
M83513 / 19-C02NW	MK-282-021-445-220R-0B7	M83513 / 19-D03NN	MK-282-025-455-000R-900	M83513 / 19-F01CN	MK-283-037-435-000R-900
M83513 / 19-C02PN	MK-285-021-445-000R-900	M83513 / 19-D03NP	MK-282-025-455-220R-900	M83513 / 19-F01CP	MK-283-037-435-220R-900
M83513 / 19-C02PP	MK-285-021-445-220R-900	M83513 / 19-D03NT	MK-282-025-455-000R-0B7	M83513 / 19-F01CT	MK-283-037-435-000R-0B7
M83513 / 19-C02PT	MK-285-021-445-000R-0B7	M83513 / 19-D03NW	MK-282-025-455-220R-0B7	M83513 / 19-F01CW	MK-283-037-435-220R-0B7
M83513 / 19-C02PW	MK-285-021-445-220R-0B7	M83513 / 19-D03PN	MK-285-025-455-000R-900	M83513 / 19-F01NN	MK-282-037-435-000R-900
M83513 / 19-C03CN	MK-283-021-455-000R-900	M83513 / 19-D03PP	MK-285-025-455-220R-900	M83513 / 19-F01NP	MK-282-037-435-220R-900
M83513 / 19-C03CP	MK-283-021-455-220R-900	M83513 / 19-D03PT	MK-285-025-455-000R-0B7	M83513 / 19-F01NT	MK-282-037-435-000R-0B7
M83513 / 19-C03CT	MK-283-021-455-000R-0B7	M83513 / 19-D03PW	MK-285-025-455-220R-0B7	M83513 / 19-F01NW	MK-282-037-435-220R-0B7
M83513 / 19-C03CW	MK-283-021-455-220R-0B7			M83513 / 19-F01PN	MK-285-037-435-000R-900
M83513 / 19-C03NN	MK-282-021-455-000R-900	M83513 / 19-E01CN	MK-283-031-435-000R-900	M83513 / 19-F01PP	MK-285-037-435-220R-900
M83513 / 19-C03NP	MK-282-021-455-220R-900	M83513 / 19-E01CP	MK-283-031-435-220R-900	M83513 / 19-F01PT	MK-285-037-435-000R-0B7
M83513 / 19-C03NT	MK-282-021-455-000R-0B7	M83513 / 19-E01CT	MK-283-031-435-000R-0B7	M83513 / 19-F01PW	MK-285-037-435-220R-0B7
M83513 / 19-C03NW	MK-282-021-455-220R-0B7	M83513 / 19-E01CW	MK-283-031-435-220R-0B7	M83513 / 19-F02CN	MK-283-037-445-000R-900
M83513 / 19-C03PN	MK-285-021-455-000R-900	M83513 / 19-E01NN	MK-282-031-435-000R-900	M83513 / 19-F02CP	MK-283-037-445-220R-900
M83513 / 19-C03PP	MK-285-021-455-220R-900	M83513 / 19-E01NP	MK-282-031-435-220R-900	M83513 / 19-F02CT	MK-283-037-445-000R-0B7
M83513 / 19-C03PT	MK-285-021-455-000R-0B7	M83513 / 19-E01NT	MK-282-031-435-000R-0B7	M83513 / 19-F02CW	MK-283-037-445-220R-0B7
M83513 / 19-C03PW	MK-285-021-455-220R-0B7	M83513 / 19-E01NW	MK-282-031-435-220R-0B7	M83513 / 19-F02NN	MK-282-037-445-000R-900
		M83513 / 19-E01PN	MK-285-031-435-000R-900	M83513 / 19-F02NP	MK-282-037-445-220R-900
M83513 / 19-D01CN	MK-283-025-435-000R-900	M83513 / 19-E01PP	MK-285-031-435-220R-900	M83513 / 19-F02NT	MK-282-037-445-000R-0B7
M83513 / 19-D01CP	MK-283-025-435-220R-900	M83513 / 19-E01PT	MK-285-031-435-000R-0B7	M83513 / 19-F02NW	MK-282-037-445-220R-0B7
M83513 / 19-D01CT	MK-283-025-435-000R-0B7	M83513 / 19-E01PW	MK-285-031-435-220R-0B7	M83513 / 19-F02PN	MK-285-037-445-000R-900
M83513 / 19-D01CW	MK-283-025-435-220R-0B7	M83513 / 19-E02CN	MK-283-031-445-000R-900	M83513 / 19-F02PP	MK-285-037-445-220R-900
M83513 / 19-D01NN	MK-282-025-435-000R-900	M83513 / 19-E02CP	MK-283-031-445-220R-900	M83513 / 19-F02PT	MK-285-037-445-000R-0B7
M83513 / 19-D01NP	MK-282-025-435-220R-900	M83513 / 19-E02CT	MK-283-031-445-000R-0B7	M83513 / 19-F02PW	MK-285-037-445-220R-0B7
M83513 / 19-D01NT	MK-282-025-435-000R-0B7	M83513 / 19-E02CW	MK-283-031-445-220R-0B7	M83513 / 19-F03CN	MK-283-037-455-000R-900
M83513 / 19-D01NW	MK-282-025-435-220R-0B7	M83513 / 19-E02NN	MK-282-031-445-000R-900	M83513 / 19-F03CP	MK-283-037-455-220R-900
M83513 / 19-D01PN	MK-285-025-435-000R-900	M83513 / 19-E02NP	MK-282-031-445-220R-900	M83513 / 19-F03CT	MK-283-037-455-000R-0B7
M83513 / 19-D01PP	MK-285-025-435-220R-900	M83513 / 19-E02NT	MK-282-031-445-000R-0B7	M83513 / 19-F03CW	MK-283-037-455-220R-0B7
M83513 / 19-D01PT	MK-285-025-435-000R-0B7	M83513 / 19-E02NW	MK-282-031-445-220R-0B7	M83513 / 19-F03NN	MK-282-037-455-000R-900
M83513 / 19-D01PW	MK-285-025-435-220R-0B7	M83513 / 19-E02PN	MK-285-031-445-000R-900	M83513 / 19-F03NP	MK-282-037-455-220R-900
M83513 / 19-D02CN	MK-283-025-445-000R-900	M83513 / 19-E02PP	MK-285-031-445-220R-900	M83513 / 19-F03NT	MK-282-037-455-000R-0B7
M83513 / 19-D02CP	MK-283-025-445-220R-900	M83513 / 19-E02PT	MK-285-031-445-000R-0B7	M83513 / 19-F03NW	MK-282-037-455-220R-0B7
M83513 / 19-D02CT	MK-283-025-445-000R-0B7	M83513 / 19-E02PW	MK-285-031-445-220R-0B7	M83513 / 19-F03PN	MK-285-037-455-000R-900
M83513 / 19-D02CW	MK-283-025-445-220R-0B7	M83513 / 19-E03CN	MK-283-031-455-000R-900	M83513 / 19-F03PP	MK-285-037-455-220R-900
M83513 / 19-D02NN	MK-282-025-445-000R-900	M83513 / 19-E03CP	MK-283-031-455-220R-900	M83513 / 19-F03PT	MK-285-037-455-000R-0B7
M83513 / 19-D02NP	MK-282-025-445-220R-900	M83513 / 19-E03CT	MK-283-031-455-000R-0B7	M83513 / 19-F03PW	MK-285-037-455-220R-0B7
M83513 / 19-D02NT	MK-282-025-445-000R-0B7	M83513 / 19-E03CW	MK-283-031-455-220R-0B7		

M83513 / 20

M83513 / 20-G01CN	MK-383-051-435-000R-900	M83513 / 20-G01PN	MK-385-051-435-000R-900	M83513 / 20-G02NN	MK-382-051-445-000R-900
M83513 / 20-G01CP	MK-383-051-435-220R-900	M83513 / 20-G01PP	MK-385-051-435-220R-900	M83513 / 20-G02NP	MK-382-051-445-220R-900
M83513 / 20-G01CT	MK-383-051-435-000R-0B7	M83513 / 20-G01PT	MK-385-051-435-000R-0B7	M83513 / 20-G02NT	MK-382-051-445-000R-0B7
M83513 / 20-G01CW	MK-383-051-435-220R-0B7	M83513 / 20-G01PW	MK-385-051-435-220R-0B7	M83513 / 20-G02NW	MK-382-051-445-220R-0B7
M83513 / 20-G01NN	MK-382-051-435-000R-900	M83513 / 20-G02CN	MK-383-051-445-000R-900	M83513 / 20-G02PN	MK-385-051-445-000R-900
M83513 / 20-G01NP	MK-382-051-435-220R-900	M83513 / 20-G02CP	MK-383-051-445-220R-900	M83513 / 20-G02PP	MK-385-051-445-220R-900
M83513 / 20-G01NT	MK-382-051-435-000R-0B7	M83513 / 20-G02CT	MK-383-051-445-000R-0B7	M83513 / 20-G02PT	MK-385-051-445-000R-0B7
M83513 / 20-G01NW	MK-382-051-435-220R-0B7	M83513 / 20-G02CW	MK-383-051-445-220R-0B7	M83513 / 20-G02PW	MK-385-051-445-220R-0B7

M83513 / 20 (continued)

M83513 / 20-G03CN	MK-382-051-455-000R-900	M83513 / 20-G03NN	MK-382-051-455-000R-900	M83513 / 20-G03PN	MK-385-051-455-000R-900
M83513 / 20-G03CP	MK-383-051-455-220R-900	M83513 / 20-G03NP	MK-382-051-455-220R-900	M83513 / 20-G03PP	MK-385-051-455-220R-900
M83513 / 20-G03CT	MK-383-051-455-000R-0B7	M83513 / 20-G03NT	MK-382-051-455-000R-0B7	M83513 / 20-G03PT	MK-385-051-455-000R-0B7
M83513 / 20-G03CW	MK-383-051-455-220R-0B7	M83513 / 20-G03NW	MK-382-051-455-220R-0B7	M83513 / 20-G03PW	MK-385-051-455-220R-0B7

M83513 / 21

M83513 / 21-H01CN	MK-483-100-435-000R-05K	M83513 / 21-H02CN	MK-483-100-445-000R-05K	M83513 / 21-H03CN	MK-483-100-455-000R-05K
M83513 / 21-H01CP	MK-483-100-435-620R-05K	M83513 / 21-H02CP	MK-483-100-445-620R-05K	M83513 / 21-H03CP	MK-483-100-455-620R-05K
M83513 / 21-H01CT	MK-483-100-435-000R-0BJ	M83513 / 21-H02CT	MK-483-100-445-000R-0BJ	M83513 / 21-H03CT	MK-483-100-455-000R-0BJ
M83513 / 21-H01CW	MK-483-100-435-620R-0BJ	M83513 / 21-H02CW	MK-483-100-445-620R-0BJ	M83513 / 21-H03CW	MK-483-100-455-620R-0BJ
M83513 / 21-H01NN	MK-482-100-435-000R-05K	M83513 / 21-H02NN	MK-482-100-445-000R-05K	M83513 / 21-H03NN	MK-482-100-455-000R-05K
M83513 / 21-H01NP	MK-482-100-435-620R-05K	M83513 / 21-H02NP	MK-482-100-445-620R-05K	M83513 / 21-H03NP	MK-482-100-455-620R-05K
M83513 / 21-H01NT	MK-482-100-435-000R-0BJ	M83513 / 21-H02NT	MK-482-100-445-000R-0BJ	M83513 / 21-H03NT	MK-482-100-455-000R-0BJ
M83513 / 21-H01NW	MK-482-100-435-620R-0BJ	M83513 / 21-H02NW	MK-482-100-445-620R-0BJ	M83513 / 21-H03NW	MK-482-100-455-620R-0BJ
M83513 / 21-H01PN	MK-485-100-435-000R-05K	M83513 / 21-H02PN	MK-485-100-445-000R-05K	M83513 / 21-H03PN	MK-485-100-455-000R-05K
M83513 / 21-H01PP	MK-485-100-435-620R-05K	M83513 / 21-H02PP	MK-485-100-445-620R-05K	M83513 / 21-H03PP	MK-485-100-455-620R-05K
M83513 / 21-H01PT	MK-485-100-435-000R-0BJ	M83513 / 21-H02PT	MK-485-100-445-000R-0BJ	M83513 / 21-H03PT	MK-485-100-455-000R-0BJ
M83513 / 21-H01PW	MK-485-100-435-620R-0BJ	M83513 / 21-H02PW	MK-485-100-445-620R-0BJ	M83513 / 21-H03PW	MK-485-100-455-620R-0BJ

M83513 / 22

M83513 / 22-A01CN	MK-213-009-125-0000	M83513 / 22-A03PW	MK-215-009-145-2200-0B7	M83513 / 22-B03PP	MK-215-015-145-2200
M83513 / 22-A01CP	MK-213-009-125-2200			M83513 / 22-B03PT	MK-215-015-145-0000-0B7
M83513 / 22-A01CT	MK-213-009-125-0000-0B7	M83513 / 22-B01CN	MK-213-015-125-0000	M83513 / 22-B03PW	MK-215-015-145-2200-0B7
M83513 / 22-A01CW	MK-213-009-125-2200-0B7	M83513 / 22-B01CP	MK-213-015-125-2200		
M83513 / 22-A01NN	MK-212-009-125-0000	M83513 / 22-B01CT	MK-213-015-125-0000-0B7	M83513 / 22-C01CN	MK-213-021-125-0000
M83513 / 22-A01NP	MK-212-009-125-2200	M83513 / 22-B01CW	MK-213-015-125-2200-0B7	M83513 / 22-C01CP	MK-213-021-125-2200
M83513 / 22-A01NT	MK-212-009-125-0000-0B7	M83513 / 22-B01NN	MK-212-015-125-0000	M83513 / 22-C01CT	MK-213-021-125-0000-0B7
M83513 / 22-A01NW	MK-212-009-125-2200-0B7	M83513 / 22-B01NP	MK-212-015-125-2200	M83513 / 22-C01CW	MK-213-021-125-2200-0B7
M83513 / 22-A01PN	MK-215-009-125-0000	M83513 / 22-B01NT	MK-212-015-125-0000-0B7	M83513 / 22-C01NN	MK-212-021-125-0000
M83513 / 22-A01PP	MK-215-009-125-2200	M83513 / 22-B01NW	MK-212-015-125-2200-0B7	M83513 / 22-C01NP	MK-212-021-125-2200
M83513 / 22-A01PT	MK-215-009-125-0000-0B7	M83513 / 22-B01PN	MK-215-015-125-0000	M83513 / 22-C01NT	MK-212-021-125-0000-0B7
M83513 / 22-A01PW	MK-215-009-125-2200-0B7	M83513 / 22-B01PP	MK-215-015-125-2200	M83513 / 22-C01NW	MK-212-021-125-2200-0B7
M83513 / 22-A02CN	MK-213-009-135-0000	M83513 / 22-B01PT	MK-215-015-125-0000-0B7	M83513 / 22-C01PN	MK-215-021-125-0000
M83513 / 22-A02CP	MK-213-009-135-2200	M83513 / 22-B01PW	MK-215-015-125-2200-0B7	M83513 / 22-C01PP	MK-215-021-125-2200
M83513 / 22-A02CT	MK-213-009-135-0000-0B7	M83513 / 22-B02CN	MK-213-015-135-0000	M83513 / 22-C01PT	MK-215-021-125-0000-0B7
M83513 / 22-A02CW	MK-213-009-135-2200-0B7	M83513 / 22-B02CP	MK-213-015-135-2200	M83513 / 22-C01PW	MK-215-021-125-2200-0B7
M83513 / 22-A02NN	MK-212-009-135-0000	M83513 / 22-B02CT	MK-213-015-135-0000-0B7	M83513 / 22-C02CN	MK-213-021-135-0000
M83513 / 22-A02NP	MK-212-009-135-2200	M83513 / 22-B02CW	MK-213-015-135-2200-0B7	M83513 / 22-C02CP	MK-213-021-135-2200
M83513 / 22-A02NT	MK-212-009-135-0000-0B7	M83513 / 22-B02NN	MK-212-015-135-0000	M83513 / 22-C02CT	MK-213-021-135-0000-0B7
M83513 / 22-A02NW	MK-212-009-135-2200-0B7	M83513 / 22-B02NP	MK-212-015-135-2200	M83513 / 22-C02CW	MK-213-021-135-2200-0B7
M83513 / 22-A02PN	MK-215-009-135-0000	M83513 / 22-B02NT	MK-212-015-135-0000-0B7	M83513 / 22-C02NN	MK-212-021-135-0000
M83513 / 22-A02PP	MK-215-009-135-2200	M83513 / 22-B02NW	MK-212-015-135-2200-0B7	M83513 / 22-C02NP	MK-212-021-135-2200
M83513 / 22-A02PT	MK-215-009-135-0000-0B7	M83513 / 22-B02PN	MK-215-015-135-0000	M83513 / 22-C02NT	MK-212-021-135-0000-0B7
M83513 / 22-A02PW	MK-215-009-135-2200-0B7	M83513 / 22-B02PP	MK-215-015-135-2200	M83513 / 22-C02NW	MK-212-021-135-2200-0B7
M83513 / 22-A03CN	MK-213-009-145-0000	M83513 / 22-B02PT	MK-215-015-135-0000-0B7	M83513 / 22-C02PN	MK-215-021-135-0000
M83513 / 22-A03CP	MK-213-009-145-2200	M83513 / 22-B02PW	MK-215-015-135-2200-0B7	M83513 / 22-C02PP	MK-215-021-135-2200
M83513 / 22-A03CT	MK-213-009-145-0000-0B7	M83513 / 22-B03CN	MK-213-015-145-0000	M83513 / 22-C02PT	MK-215-021-135-0000-0B7
M83513 / 22-A03CW	MK-213-009-145-2200-0B7	M83513 / 22-B03CP	MK-213-015-145-2200	M83513 / 22-C02PW	MK-215-021-135-2200-0B7
M83513 / 22-A03NN	MK-212-009-145-0000	M83513 / 22-B03CT	MK-213-015-145-0000-0B7	M83513 / 22-C03CN	MK-213-021-145-0000
M83513 / 22-A03NP	MK-212-009-145-2200	M83513 / 22-B03CW	MK-213-015-145-2200-0B7	M83513 / 22-C03CP	MK-213-021-145-2200
M83513 / 22-A03NT	MK-212-009-145-0000-0B7	M83513 / 22-B03NN	MK-212-015-145-0000	M83513 / 22-C03CT	MK-213-021-145-0000-0B7
M83513 / 22-A03NW	MK-212-009-145-2200-0B7	M83513 / 22-B03NP	MK-212-015-145-2200	M83513 / 22-C03CW	MK-213-021-145-2200-0B7
M83513 / 22-A03PN	MK-215-009-145-0000	M83513 / 22-B03NT	MK-212-015-145-0000-0B7	M83513 / 22-C03NN	MK-212-021-145-0000
M83513 / 22-A03PP	MK-215-009-145-2200	M83513 / 22-B03NW	MK-212-015-145-2200-0B7	M83513 / 22-C03NP	MK-212-021-145-2200
M83513 / 22-A03PT	MK-215-009-145-0000-0B7	M83513 / 22-B03PN	MK-215-015-145-0000	M83513 / 22-C03NT	MK-212-021-145-0000-0B7

Military Cross Reference Chart

-- Continued from previous page



M83513 / 22 (continued)

M83513 / 22-C03NW	MK-212-021-145-2200-0B7	M83513 / 22-D03PP	MK-215-025-145-2200	M83513 / 22-E03PW	MK-215-031-145-2200-0B7
M83513 / 22-C03PN	MK-215-021-145-0000	M83513 / 22-D03PT	MK-215-025-145-0000-0B7		
M83513 / 22-C03PP	MK-215-021-145-2200	M83513 / 22-D03PW	MK-215-025-145-2200-0B7		
M83513 / 22-C03PT	MK-215-021-145-0000-0B7				
M83513 / 22-C03PW	MK-215-021-145-2200-0B7				
<hr/>					
M83513 / 22-D01CN	MK-213-025-125-0000	M83513 / 22-E01CN	MK-213-031-125-0000		
M83513 / 22-D01CP	MK-213-025-125-2200	M83513 / 22-E01CP	MK-213-031-125-2200		
M83513 / 22-D01CT	MK-213-025-125-0000-0B7	M83513 / 22-E01CT	MK-213-031-125-0000-0B7		
M83513 / 22-D01CW	MK-213-025-125-2200-0B7	M83513 / 22-E01CW	MK-213-031-125-2200-0B7		
M83513 / 22-D01NN	MK-212-025-125-0000	M83513 / 22-E01NN	MK-212-031-125-0000		
M83513 / 22-D01NP	MK-212-025-125-2200	M83513 / 22-E01NP	MK-212-031-125-2200		
M83513 / 22-D01NT	MK-212-025-125-0000-0B7	M83513 / 22-E01NT	MK-212-031-125-0000-0B7		
M83513 / 22-D01NW	MK-212-025-125-2200-0B7	M83513 / 22-E01NW	MK-212-031-125-2200-0B7		
M83513 / 22-D01PN	MK-215-025-125-0000	M83513 / 22-E01PN	MK-215-031-125-0000		
M83513 / 22-D01PP	MK-215-025-125-2200	M83513 / 22-E01PP	MK-215-031-125-2200		
M83513 / 22-D01PT	MK-215-025-125-0000-0B7	M83513 / 22-E01PT	MK-215-031-125-0000-0B7		
M83513 / 22-D01PW	MK-215-025-125-2200-0B7	M83513 / 22-E01PW	MK-215-031-125-2200-0B7		
M83513 / 22-D02CN	MK-213-025-135-0000	M83513 / 22-E02CN	MK-213-031-135-0000		
M83513 / 22-D02CP	MK-213-025-135-2200	M83513 / 22-E02CP	MK-213-031-135-2200		
M83513 / 22-D02CT	MK-213-025-135-0000-0B7	M83513 / 22-E02CT	MK-213-031-135-0000-0B7		
M83513 / 22-D02CW	MK-213-025-135-2200-0B7	M83513 / 22-E02CW	MK-213-031-135-2200-0B7		
M83513 / 22-D02NN	MK-212-025-135-0000	M83513 / 22-E02NN	MK-212-031-135-0000		
M83513 / 22-D02NP	MK-212-025-135-2200	M83513 / 22-E02NP	MK-212-031-135-2200		
M83513 / 22-D02NT	MK-212-025-135-0000-0B7	M83513 / 22-E02NT	MK-212-031-135-0000-0B7		
M83513 / 22-D02NW	MK-212-025-135-2200-0B7	M83513 / 22-E02NW	MK-212-031-135-2200-0B7		
M83513 / 22-D02PN	MK-215-025-135-0000	M83513 / 22-E02PN	MK-215-031-135-0000		
M83513 / 22-D02PP	MK-215-025-135-2200	M83513 / 22-E02PP	MK-215-031-135-2200		
M83513 / 22-D02PT	MK-215-025-135-0000-0B7	M83513 / 22-E02PT	MK-215-031-135-0000-0B7		
M83513 / 22-D02PW	MK-215-025-135-2200-0B7	M83513 / 22-E02PW	MK-215-031-135-2200-0B7		
M83513 / 22-D03CN	MK-213-025-145-0000	M83513 / 22-E03CN	MK-213-031-145-0000		
M83513 / 22-D03CP	MK-213-025-145-2200	M83513 / 22-E03CP	MK-213-031-145-2200		
M83513 / 22-D03CT	MK-213-025-145-0000-0B7	M83513 / 22-E03CT	MK-213-031-145-0000-0B7		
M83513 / 22-D03CW	MK-213-025-145-2200-0B7	M83513 / 22-E03CW	MK-213-031-145-2200-0B7		
M83513 / 22-D03NN	MK-212-025-145-0000	M83513 / 22-E03NN	MK-212-031-145-0000		
M83513 / 22-D03NP	MK-212-025-145-2200	M83513 / 22-E03NP	MK-212-031-145-2200		
M83513 / 22-D03NT	MK-212-025-145-0000-0B7	M83513 / 22-E03NT	MK-212-031-145-0000-0B7		
M83513 / 22-D03NW	MK-212-025-145-2200-0B7	M83513 / 22-E03NW	MK-212-031-145-2200-0B7		
M83513 / 22-D03PN	MK-215-025-145-0000	M83513 / 22-E03PN	MK-215-031-145-0000		
		M83513 / 22-E03PP	MK-215-031-145-2200		
		M83513 / 22-E03PT	MK-215-031-145-0000-0B7		

M83513 / 23

M83513 / 23-G01CN	MK-313-051-125-0000	M83513 / 23-G02CN	MK-313-051-135-0000	M83513 / 23-G03CN	MK-313-051-145-0000
M83513 / 23-G01CP	MK-313-051-125-2200	M83513 / 23-G02CP	MK-313-051-135-2200	M83513 / 23-G03CP	MK-313-051-145-2200
M83513 / 23-G01CT	MK-313-051-125-0000-0B7	M83513 / 23-G02CT	MK-313-051-135-0000-0B7	M83513 / 23-G03CT	MK-313-051-145-0000-0B7
M83513 / 23-G01CW	MK-313-051-125-2200-0B7	M83513 / 23-G02CW	MK-313-051-135-2200-0B7	M83513 / 23-G03CW	MK-313-051-145-2200-0B7
M83513 / 23-G01NN	MK-312-051-125-0000	M83513 / 23-G02NN	MK-312-051-135-0000	M83513 / 23-G03NN	MK-312-051-145-0000
M83513 / 23-G01NP	MK-312-051-125-2200	M83513 / 23-G02NP	MK-312-051-135-2200	M83513 / 23-G03NP	MK-312-051-145-2200
M83513 / 23-G01NT	MK-312-051-125-0000-0B7	M83513 / 23-G02NT	MK-312-051-135-0000-0B7	M83513 / 23-G03NT	MK-312-051-145-0000-0B7
M83513 / 23-G01NW	MK-312-051-125-2200-0B7	M83513 / 23-G02NW	MK-312-051-135-2200-0B7	M83513 / 23-G03NW	MK-312-051-145-2200-0B7
M83513 / 23-G01PN	MK-315-051-125-0000	M83513 / 23-G02PN	MK-315-051-135-0000	M83513 / 23-G03PN	MK-315-051-145-0000
M83513 / 23-G01PP	MK-315-051-125-2200	M83513 / 23-G02PP	MK-315-051-135-2200	M83513 / 23-G03PP	MK-315-051-145-2200
M83513 / 23-G01PT	MK-315-051-125-0000-0B7	M83513 / 23-G02PT	MK-315-051-135-0000-0B7	M83513 / 23-G03PT	MK-315-051-145-0000-0B7
M83513 / 23-G01PW	MK-315-051-125-2200-0B7	M83513 / 23-G02PW	MK-315-051-135-2200-0B7	M83513 / 23-G03PW	MK-315-051-145-2200-0B7

M83513 / 27 (continued)

M83513 / 27-H02NT	MK-422-100-235-0000-0B7	M83513 / 27-H03CN	MK-423-100-245-0000-900	M83513 / 27-H03NT	MK-422-100-245-0000-0B7
M83513 / 27-H02NW	MK-422-100-235-6200-0B7	M83513 / 27-H03CP	MK-423-100-245-6200-900	M83513 / 27-H03NW	MK-422-100-245-6200-0B7
M83513 / 27-H02PN	MK-425-100-235-0000-900	M83513 / 27-H03CT	MK-423-100-245-0000-0B7	M83513 / 27-H03PN	MK-425-100-245-0000-900
M83513 / 27-H02PP	MK-425-100-235-6200-900	M83513 / 27-H03CW	MK-423-100-245-6200-0B7	M83513 / 27-H03PP	MK-425-100-245-6200-900
M83513 / 27-H02PT	MK-425-100-235-0000-0B7	M83513 / 27-H03NN	MK-422-100-245-0000-900	M83513 / 27-H03PT	MK-425-100-245-0000-0B7
M83513 / 27-H02PW	MK-425-100-235-6200-0B7	M83513 / 27-H03NP	MK-422-100-245-6200-900	M83513 / 27-H03PW	MK-425-100-245-6200-0B7

M83513 / 28

M83513 / 28-A01CN	MK-233-009-125-0000	M83513 / 28-B01PT	MK-235-015-125-0000-0B7	M83513 / 28-C02PN	MK-235-021-135-0000
M83513 / 28-A01CP	MK-233-009-125-2200	M83513 / 28-B01PW	MK-235-015-125-2200-0B7	M83513 / 28-C02PP	MK-235-021-135-2200
M83513 / 28-A01CT	MK-233-009-125-0000-0B7	M83513 / 28-B02CN	MK-233-015-135-0000	M83513 / 28-C02PT	MK-235-021-135-0000-0B7
M83513 / 28-A01CW	MK-233-009-125-2200-0B7	M83513 / 28-B02CP	MK-233-015-135-2200	M83513 / 28-C02PW	MK-235-021-135-2200-0B7
M83513 / 28-A01NN	MK-232-009-125-0000	M83513 / 28-B02CT	MK-233-015-135-0000-0B7	M83513 / 28-C03CN	MK-233-021-145-0000
M83513 / 28-A01NP	MK-232-009-125-2200	M83513 / 28-B02CW	MK-233-015-135-2200-0B7	M83513 / 28-C03CP	MK-233-021-145-2200
M83513 / 28-A01NT	MK-232-009-125-0000-0B7	M83513 / 28-B02NN	MK-232-015-135-0000	M83513 / 28-C03CT	MK-233-021-145-0000-0B7
M83513 / 28-A01NW	MK-232-009-125-2200-0B7	M83513 / 28-B02NP	MK-232-015-135-2200	M83513 / 28-C03CW	MK-233-021-145-2200-0B7
M83513 / 28-A01PN	MK-235-009-125-0000	M83513 / 28-B02NT	MK-232-015-135-0000-0B7	M83513 / 28-C03NN	MK-232-021-145-0000
M83513 / 28-A01PP	MK-235-009-125-2200	M83513 / 28-B02NW	MK-232-015-135-2200-0B7	M83513 / 28-C03NP	MK-232-021-145-2200
M83513 / 28-A01PT	MK-235-009-125-0000-0B7	M83513 / 28-B02PN	MK-235-015-135-0000	M83513 / 28-C03NT	MK-232-021-145-0000-0B7
M83513 / 28-A01PW	MK-235-009-125-2200-0B7	M83513 / 28-B02PP	MK-235-015-135-2200	M83513 / 28-C03NW	MK-232-021-145-2200-0B7
M83513 / 28-A02CN	MK-233-009-135-0000	M83513 / 28-B02PT	MK-235-015-135-0000-0B7	M83513 / 28-C03PN	MK-235-021-145-0000
M83513 / 28-A02CP	MK-233-009-135-2200	M83513 / 28-B02PW	MK-235-015-135-2200-0B7	M83513 / 28-C03PP	MK-235-021-145-2200
M83513 / 28-A02CT	MK-233-009-135-0000-0B7	M83513 / 28-B03CN	MK-233-015-145-0000	M83513 / 28-C03PT	MK-235-021-145-0000-0B7
M83513 / 28-A02CW	MK-233-009-135-2200-0B7	M83513 / 28-B03CP	MK-233-015-145-2200	M83513 / 28-C03PW	MK-235-021-145-2200-0B7
M83513 / 28-A02NN	MK-232-009-135-0000	M83513 / 28-B03CT	MK-233-015-145-0000-0B7		
M83513 / 28-A02NP	MK-232-009-135-2200	M83513 / 28-B03CW	MK-233-015-145-2200-0B7	M83513 / 28-D01CN	MK-233-025-125-0000
M83513 / 28-A02NT	MK-232-009-135-0000-0B7	M83513 / 28-B03NN	MK-232-015-145-0000	M83513 / 28-D01CP	MK-233-025-125-2200
M83513 / 28-A02NW	MK-232-009-135-2200-0B7	M83513 / 28-B03NP	MK-232-015-145-2200	M83513 / 28-D01CT	MK-233-025-125-0000-0B7
M83513 / 28-A02PN	MK-235-009-135-0000	M83513 / 28-B03NT	MK-232-015-145-0000-0B7	M83513 / 28-D01CW	MK-233-025-125-2200-0B7
M83513 / 28-A02PP	MK-235-009-135-2200	M83513 / 28-B03NW	MK-232-015-145-2200-0B7	M83513 / 28-D01NN	MK-232-025-125-0000
M83513 / 28-A02PT	MK-235-009-135-0000-0B7	M83513 / 28-B03PN	MK-235-015-145-0000	M83513 / 28-D01NP	MK-232-025-125-2200
M83513 / 28-A02PW	MK-235-009-135-2200-0B7	M83513 / 28-B03PP	MK-235-015-145-2200	M83513 / 28-D01NT	MK-232-025-125-0000-0B7
M83513 / 28-A03CN	MK-233-009-145-0000	M83513 / 28-B03PT	MK-235-015-145-0000-0B7	M83513 / 28-D01NW	MK-232-025-125-2200-0B7
M83513 / 28-A03CP	MK-233-009-145-2200	M83513 / 28-B03PW	MK-235-015-145-2200-0B7	M83513 / 28-D01PN	MK-235-025-125-0000
M83513 / 28-A03CT	MK-233-009-145-0000-0B7			M83513 / 28-D01PP	MK-235-025-125-2200
M83513 / 28-A03CW	MK-233-009-145-2200-0B7	M83513 / 28-C01CN	MK-233-021-125-0000	M83513 / 28-D01PT	MK-235-025-125-0000-0B7
M83513 / 28-A03NN	MK-232-009-145-0000	M83513 / 28-C01CP	MK-233-021-125-2200	M83513 / 28-D01PW	MK-235-025-125-2200-0B7
M83513 / 28-A03NP	MK-232-009-145-2200	M83513 / 28-C01CT	MK-233-021-125-0000-0B7	M83513 / 28-D02CN	MK-233-025-135-0000
M83513 / 28-A03NT	MK-232-009-145-0000-0B7	M83513 / 28-C01CW	MK-233-021-125-2200-0B7	M83513 / 28-D02CP	MK-233-025-135-2200
M83513 / 28-A03NW	MK-232-009-145-2200-0B7	M83513 / 28-C01NN	MK-232-021-125-0000	M83513 / 28-D02CT	MK-233-025-135-0000-0B7
M83513 / 28-A03PN	MK-235-009-145-0000	M83513 / 28-C01NP	MK-232-021-125-2200	M83513 / 28-D02CW	MK-233-025-135-2200-0B7
M83513 / 28-A03PP	MK-235-009-145-2200	M83513 / 28-C01NT	MK-232-021-125-0000-0B7	M83513 / 28-D02NN	MK-232-025-135-0000
M83513 / 28-A03PT	MK-235-009-145-0000-0B7	M83513 / 28-C01NW	MK-232-021-125-2200-0B7	M83513 / 28-D02NP	MK-232-025-135-2200
M83513 / 28-A03PW	MK-235-009-145-2200-0B7	M83513 / 28-C01PN	MK-235-021-125-0000	M83513 / 28-D02NT	MK-232-025-135-0000-0B7
		M83513 / 28-C01PP	MK-235-021-125-2200	M83513 / 28-D02NW	MK-232-025-135-2200-0B7
M83513 / 28-B01CN	MK-233-015-125-0000	M83513 / 28-C01PT	MK-235-021-125-0000-0B7	M83513 / 28-D02PN	MK-235-025-135-0000
M83513 / 28-B01CP	MK-233-015-125-2200	M83513 / 28-C01PW	MK-235-021-125-2200-0B7	M83513 / 28-D02PP	MK-235-025-135-2200
M83513 / 28-B01CT	MK-233-015-125-0000-0B7	M83513 / 28-C02CN	MK-233-021-135-0000	M83513 / 28-D02PT	MK-235-025-135-0000-0B7
M83513 / 28-B01CW	MK-233-015-125-2200-0B7	M83513 / 28-C02CP	MK-233-021-135-2200	M83513 / 28-D02PW	MK-235-025-135-2200-0B7
M83513 / 28-B01NN	MK-232-015-125-0000	M83513 / 28-C02CT	MK-233-021-135-0000-0B7	M83513 / 28-D03CN	MK-233-025-145-0000
M83513 / 28-B01NP	MK-232-015-125-2200	M83513 / 28-C02CW	MK-233-021-135-2200-0B7	M83513 / 28-D03CP	MK-233-025-145-2200
M83513 / 28-B01NT	MK-232-015-125-0000-0B7	M83513 / 28-C02NN	MK-232-021-135-0000	M83513 / 28-D03CT	MK-233-025-145-0000-0B7
M83513 / 28-B01NW	MK-232-015-125-2200-0B7	M83513 / 28-C02NP	MK-232-021-135-2200	M83513 / 28-D03CW	MK-233-025-145-2200-0B7
M83513 / 28-B01PN	MK-235-015-125-0000	M83513 / 28-C02NT	MK-232-021-135-0000-0B7	M83513 / 28-D03NN	MK-232-025-145-0000
M83513 / 28-B01PP	MK-235-015-125-2200	M83513 / 28-C02NW	MK-232-021-135-2200-0B7	M83513 / 28-D03NP	MK-232-025-145-2200

Military Cross Reference Chart

-- Continued from previous page



M83513 / 28 (continued)

M83513 / 28-D03NT	MK-232-025-145-0000-0B7	M83513 / 28-E02PN	MK-235-031-135-0000	M83513 / 28-F01PT	MK-235-037-125-0000-0B7
M83513 / 28-D03NW	MK-232-025-145-2200-0B7	M83513 / 28-E02PP	MK-235-031-135-2200	M83513 / 28-F01PW	MK-235-037-125-2200-0B7
M83513 / 28-D03PN	MK-235-025-145-0000	M83513 / 28-E02PT	MK-235-031-135-0000-0B7	M83513 / 28-F02CN	MK-233-037-135-0000
M83513 / 28-D03PP	MK-235-025-145-2200	M83513 / 28-E02PW	MK-235-031-135-2200-0B7	M83513 / 28-F02CP	MK-233-037-135-2200
M83513 / 28-D03PT	MK-235-025-145-0000-0B7	M83513 / 28-E03CN	MK-233-031-145-0000	M83513 / 28-F02CT	MK-233-037-135-0000-0B7
M83513 / 28-D03PW	MK-235-025-145-2200-0B7	M83513 / 28-E03CP	MK-233-031-145-2200	M83513 / 28-F02CW	MK-233-037-135-2200-0B7
<hr/>					
M83513 / 28-E01CN	MK-233-031-125-0000	M83513 / 28-E03CT	MK-233-031-145-0000-0B7	M83513 / 28-F02NN	MK-232-037-135-0000
M83513 / 28-E01CP	MK-233-031-125-2200	M83513 / 28-E03CW	MK-233-031-145-2200-0B7	M83513 / 28-F02NP	MK-232-037-135-2200
M83513 / 28-E01CT	MK-233-031-125-0000-0B7	M83513 / 28-E03NN	MK-232-031-145-0000	M83513 / 28-F02NT	MK-232-037-135-0000-0B7
M83513 / 28-E01CW	MK-233-031-125-2200-0B7	M83513 / 28-E03NP	MK-232-031-145-2200	M83513 / 28-F02NW	MK-232-037-135-2200-0B7
M83513 / 28-E01NN	MK-232-031-125-0000	M83513 / 28-E03NT	MK-232-031-145-0000-0B7	M83513 / 28-F02NP	MK-235-037-135-0000
M83513 / 28-E01NP	MK-232-031-125-2200	M83513 / 28-E03PN	MK-232-031-145-2200-0B7	M83513 / 28-F02PP	MK-235-037-135-2200
M83513 / 28-E01NT	MK-232-031-125-0000-0B7	M83513 / 28-E03PP	MK-235-031-145-0000	M83513 / 28-F02PT	MK-235-037-135-0000-0B7
M83513 / 28-E01NW	MK-232-031-125-2200-0B7	M83513 / 28-E03PT	MK-235-031-145-0000-0B7	M83513 / 28-F02PW	MK-235-037-135-2200-0B7
M83513 / 28-E01PN	MK-235-031-125-0000	M83513 / 28-E03PW	MK-235-031-145-2200-0B7	M83513 / 28-F03CN	MK-233-037-145-0000
M83513 / 28-E01PP	MK-235-031-125-2200	<hr/>			
M83513 / 28-E01PT	MK-235-031-125-0000-0B7	M83513 / 28-F01CN	MK-233-037-125-0000	M83513 / 28-F03CP	MK-233-037-145-2200
M83513 / 28-E01PW	MK-235-031-125-2200-0B7	M83513 / 28-F01CP	MK-233-037-125-2200	M83513 / 28-F03CT	MK-233-037-145-0000-0B7
M83513 / 28-E02CN	MK-233-031-135-0000	M83513 / 28-F01CT	MK-233-037-125-0000-0B7	M83513 / 28-F03CW	MK-233-037-145-2200-0B7
M83513 / 28-E02CP	MK-233-031-135-2200	M83513 / 28-F01CW	MK-233-037-125-2200-0B7	M83513 / 28-F03NN	MK-232-037-145-0000
M83513 / 28-E02CT	MK-233-031-135-0000-0B7	M83513 / 28-F01NN	MK-232-037-125-0000	M83513 / 28-F03NP	MK-232-037-145-2200
M83513 / 28-E02CW	MK-233-031-135-2200-0B7	M83513 / 28-F01NP	MK-232-037-125-2200	M83513 / 28-F03NT	MK-232-037-145-0000-0B7
M83513 / 28-E02NN	MK-232-031-135-0000	M83513 / 28-F01NT	MK-232-037-125-0000-0B7	M83513 / 28-F03NW	MK-232-037-145-2200-0B7
M83513 / 28-E02NP	MK-232-031-135-2200	M83513 / 28-F01NW	MK-232-037-125-2200-0B7	M83513 / 28-F03NN	MK-235-037-145-0000
M83513 / 28-E02NT	MK-232-031-135-0000-0B7	M83513 / 28-F01PN	MK-235-037-125-0000	M83513 / 28-F03PP	MK-235-037-145-2200
M83513 / 28-E02NW	MK-232-031-135-2200-0B7	M83513 / 28-F01PP	MK-235-037-125-2200	M83513 / 28-F03PT	MK-235-037-145-0000-0B7
				M83513 / 28-F03PW	MK-235-037-145-2200-0B7

M83513 / 29

M83513 / 29-G01CN	MK-333-051-125-0000	M83513 / 29-G02CN	MK-333-051-135-0000	M83513 / 29-G03CN	MK-333-051-145-0000
M83513 / 29-G01CP	MK-333-051-125-2200	M83513 / 29-G02CP	MK-333-051-135-2200	M83513 / 29-G03CP	MK-333-051-145-2200
M83513 / 29-G01CT	MK-333-051-125-0000-0B7	M83513 / 29-G02CT	MK-333-051-135-0000-0B7	M83513 / 29-G03CT	MK-333-051-145-0000-0B7
M83513 / 29-G01CW	MK-333-051-125-2200-0B7	M83513 / 29-G02CW	MK-333-051-135-2200-0B7	M83513 / 29-G03CW	MK-333-051-145-2200-0B7
M83513 / 29-G01NN	MK-332-051-125-0000	M83513 / 29-G02NN	MK-332-051-135-0000	M83513 / 29-G03NN	MK-332-051-145-0000
M83513 / 29-G01NP	MK-332-051-125-2200	M83513 / 29-G02NP	MK-332-051-135-2200	M83513 / 29-G03NP	MK-332-051-145-2200
M83513 / 29-G01NT	MK-332-051-125-0000-0B7	M83513 / 29-G02NT	MK-332-051-135-0000-0B7	M83513 / 29-G03NT	MK-332-051-145-0000-0B7
M83513 / 29-G01NW	MK-332-051-125-2200-0B7	M83513 / 29-G02NW	MK-332-051-135-2200-0B7	M83513 / 29-G03NW	MK-332-051-145-2200-0B7
M83513 / 29-G01PN	MK-335-051-125-0000	M83513 / 29-G02PP	MK-335-051-135-0000	M83513 / 29-G03PN	MK-335-051-145-0000
M83513 / 29-G01PP	MK-335-051-125-2200	M83513 / 29-G02PT	MK-335-051-135-2200	M83513 / 29-G03PP	MK-335-051-145-2200
M83513 / 29-G01PT	MK-335-051-125-0000-0B7	M83513 / 29-G02PT	MK-335-051-135-0000-0B7	M83513 / 29-G03PT	MK-335-051-145-0000-0B7
M83513 / 29-G01PW	MK-335-051-125-2200-0B7	M83513 / 29-G02PW	MK-335-051-135-2200-0B7	M83513 / 29-G03PW	MK-335-051-145-2200-0B7

M83513 / 30

M83513 / 30-H01CN	MK-433-100-125-0000	M83513 / 30-H02CN	MK-433-100-135-0000	M83513 / 30-H03CN	MK-433-100-145-0000
M83513 / 30-H01CP	MK-433-100-125-6200	M83513 / 30-H02CP	MK-433-100-135-6200	M83513 / 30-H03CP	MK-433-100-145-6200
M83513 / 30-H01CT	MK-433-100-125-0000-0B7	M83513 / 30-H02CT	MK-433-100-135-0000-0B7	M83513 / 30-H03CT	MK-433-100-145-0000-0B7
M83513 / 30-H01CW	MK-433-100-125-6200-0B7	M83513 / 30-H02CW	MK-433-100-135-6200-0B7	M83513 / 30-H03CW	MK-433-100-145-6200-0B7
M83513 / 30-H01NN	MK-432-100-125-0000	M83513 / 30-H02NN	MK-432-100-135-0000	M83513 / 30-H03NN	MK-432-100-145-0000
M83513 / 30-H01NP	MK-432-100-125-6200	M83513 / 30-H02NP	MK-432-100-135-6200	M83513 / 30-H03NP	MK-432-100-145-6200
M83513 / 30-H01NT	MK-432-100-125-0000-0B7	M83513 / 30-H02NT	MK-432-100-135-0000-0B7	M83513 / 30-H03NT	MK-432-100-145-0000-0B7
M83513 / 30-H01NW	MK-432-100-125-6200-0B7	M83513 / 30-H02NW	MK-432-100-135-6200-0B7	M83513 / 30-H03NW	MK-432-100-145-6200-0B7
M83513 / 30-H01PN	MK-435-100-125-0000	M83513 / 30-H02PP	MK-435-100-135-0000	M83513 / 30-H03PN	MK-435-100-145-0000
M83513 / 30-H01PP	MK-435-100-125-6200	M83513 / 30-H02PT	MK-435-100-135-6200	M83513 / 30-H03PP	MK-435-100-145-6200
M83513 / 30-H01PT	MK-435-100-125-0000-0B7	M83513 / 30-H02PT	MK-435-100-135-0000-0B7	M83513 / 30-H03PT	MK-435-100-145-0000-0B7
M83513 / 30-H01PW	MK-435-100-125-6200-0B7	M83513 / 30-H02PW	MK-435-100-135-6200-0B7	M83513 / 30-H03PW	MK-435-100-145-6200-0B7

Military Cross Reference Chart

-- Continued from previous page



M83513 / 31 (continued)

M83513 / 31-E02NT	MK-242-031-235-0000-0B7	M83513 / 31-F01CN	MK-243-037-225-0000-900	M83513 / 31-F02NT	MK-242-037-235-0000-0B7
M83513 / 31-E02NW	MK-242-031-235-2200-0B7	M83513 / 31-F01CP	MK-243-037-225-2200-900	M83513 / 31-F02NW	MK-242-037-235-2200-0B7
M83513 / 31-E02PN	MK-245-031-235-0000-900	M83513 / 31-F01CT	MK-243-037-225-0000-0B7	M83513 / 31-F02PN	MK-245-037-235-0000-900
M83513 / 31-E02PP	MK-245-031-235-2200-900	M83513 / 31-F01CW	MK-243-037-225-2200-0B7	M83513 / 31-F02PP	MK-245-037-235-2200-900
M83513 / 31-E02PT	MK-245-031-235-0000-0B7	M83513 / 31-F01NN	MK-242-037-225-0000-900	M83513 / 31-F02PT	MK-245-037-235-0000-0B7
M83513 / 31-E02PW	MK-245-031-235-2200-0B7	M83513 / 31-F01NP	MK-242-037-225-2200-900	M83513 / 31-F02PW	MK-245-037-235-2200-0B7
M83513 / 31-E03CN	MK-243-031-245-0000-900	M83513 / 31-F01NT	MK-242-037-225-0000-0B7	M83513 / 31-F03CN	MK-243-037-245-0000-900
M83513 / 31-E03CP	MK-243-031-245-2200-900	M83513 / 31-F01NW	MK-242-037-225-2200-0B7	M83513 / 31-F03CP	MK-243-037-245-2200-900
M83513 / 31-E03CT	MK-243-031-245-0000-0B7	M83513 / 31-F01PN	MK-245-037-225-0000-900	M83513 / 31-F03CT	MK-243-037-245-0000-0B7
M83513 / 31-E03CW	MK-243-031-245-2200-0B7	M83513 / 31-F01PP	MK-245-037-225-2200-900	M83513 / 31-F03CW	MK-243-037-245-2200-0B7
M83513 / 31-E03NN	MK-242-031-245-0000-900	M83513 / 31-F01PT	MK-245-037-225-0000-0B7	M83513 / 31-F03NN	MK-242-037-245-0000-900
M83513 / 31-E03NP	MK-242-031-245-2200-900	M83513 / 31-F01PW	MK-245-037-225-2200-0B7	M83513 / 31-F03NP	MK-242-037-245-2200-900
M83513 / 31-E03NT	MK-242-031-245-0000-0B7	M83513 / 31-F02CN	MK-243-037-235-0000-900	M83513 / 31-F03NT	MK-242-037-245-0000-0B7
M83513 / 31-E03NW	MK-242-031-245-2200-0B7	M83513 / 31-F02CP	MK-243-037-235-2200-900	M83513 / 31-F03NW	MK-242-037-245-2200-0B7
M83513 / 31-E03PN	MK-245-031-245-0000-900	M83513 / 31-F02CT	MK-243-037-235-0000-0B7	M83513 / 31-F03PN	MK-245-037-245-0000-900
M83513 / 31-E03PP	MK-245-031-245-2200-900	M83513 / 31-F02CW	MK-243-037-235-2200-0B7	M83513 / 31-F03PP	MK-245-037-245-2200-900
M83513 / 31-E03PT	MK-245-031-245-0000-0B7	M83513 / 31-F02NN	MK-242-037-235-0000-900	M83513 / 31-F03PT	MK-245-037-245-0000-0B7
M83513 / 31-E03PW	MK-245-031-245-2200-0B7	M83513 / 31-F02NP	MK-242-037-235-2200-900	M83513 / 31-F03PW	MK-245-037-245-2200-0B7

M83513 / 32

M83513 / 32-G01CN	MK-343-051-225-0000-900	M83513 / 32-G02CN	MK-343-051-235-0000-900	M83513 / 32-G03CN	MK-343-051-245-0000-900
M83513 / 32-G01CP	MK-343-051-225-2200-900	M83513 / 32-G02CP	MK-343-051-235-2200-900	M83513 / 32-G03CP	MK-343-051-245-2200-900
M83513 / 32-G01CT	MK-343-051-225-0000-0B7	M83513 / 32-G02CT	MK-343-051-235-0000-0B7	M83513 / 32-G03CT	MK-343-051-245-0000-0B7
M83513 / 32-G01CW	MK-343-051-225-2200-0B7	M83513 / 32-G02CW	MK-343-051-235-2200-0B7	M83513 / 32-G03CW	MK-343-051-245-2200-0B7
M83513 / 32-G01NN	MK-342-051-225-0000-900	M83513 / 32-G02NN	MK-342-051-235-0000-900	M83513 / 32-G03NN	MK-342-051-245-0000-900
M83513 / 32-G01NP	MK-342-051-225-2200-900	M83513 / 32-G02NP	MK-342-051-235-2200-900	M83513 / 32-G03NP	MK-342-051-245-2200-900
M83513 / 32-G01NT	MK-342-051-225-0000-0B7	M83513 / 32-G02NT	MK-342-051-235-0000-0B7	M83513 / 32-G03NT	MK-342-051-245-0000-0B7
M83513 / 32-G01NW	MK-342-051-225-2200-0B7	M83513 / 32-G02NW	MK-342-051-235-2200-0B7	M83513 / 32-G03NW	MK-342-051-245-2200-0B7
M83513 / 32-G01PN	MK-345-051-225-0000-900	M83513 / 32-G02PN	MK-345-051-235-0000-900	M83513 / 32-G03PN	MK-345-051-245-0000-900
M83513 / 32-G01PP	MK-345-051-225-2200-900	M83513 / 32-G02PP	MK-345-051-235-2200-900	M83513 / 32-G03PP	MK-345-051-245-2200-900
M83513 / 32-G01PT	MK-345-051-225-0000-0B7	M83513 / 32-G02PT	MK-345-051-235-0000-0B7	M83513 / 32-G03PT	MK-345-051-245-0000-0B7
M83513 / 32-G01PW	MK-345-051-225-2200-0B7	M83513 / 32-G02PW	MK-345-051-235-2200-0B7	M83513 / 32-G03PW	MK-345-051-245-2200-0B7

M83513 / 33

M83513 / 33-H01CN	MK-443-100-225-0000-900	M83513 / 33-H02CN	MK-443-100-235-0000-900	M83513 / 33-H03CN	MK-443-100-245-0000-900
M83513 / 33-H01CP	MK-443-100-225-6200-900	M83513 / 33-H02CP	MK-443-100-235-6200-900	M83513 / 33-H03CP	MK-443-100-245-6200-900
M83513 / 33-H01CT	MK-443-100-225-0000-0B7	M83513 / 33-H02CT	MK-443-100-235-0000-0B7	M83513 / 33-H03CT	MK-443-100-245-0000-0B7
M83513 / 33-H01CW	MK-443-100-225-6200-0B7	M83513 / 33-H02CW	MK-443-100-235-6200-0B7	M83513 / 33-H03CW	MK-443-100-245-6200-0B7
M83513 / 33-H01NN	MK-442-100-225-0000-900	M83513 / 33-H02NN	MK-442-100-235-0000-900	M83513 / 33-H03NN	MK-442-100-245-0000-900
M83513 / 33-H01NP	MK-442-100-225-6200-900	M83513 / 33-H02NP	MK-442-100-235-6200-900	M83513 / 33-H03NP	MK-442-100-245-6200-900
M83513 / 33-H01NT	MK-442-100-225-0000-0B7	M83513 / 33-H02NT	MK-442-100-235-0000-0B7	M83513 / 33-H03NT	MK-442-100-245-0000-0B7
M83513 / 33-H01NW	MK-442-100-225-6200-0B7	M83513 / 33-H02NW	MK-442-100-235-6200-0B7	M83513 / 33-H03NW	MK-442-100-245-6200-0B7
M83513 / 33-H01PN	MK-445-100-225-0000-900	M83513 / 33-H02PN	MK-445-100-235-0000-900	M83513 / 33-H03PN	MK-445-100-245-0000-900
M83513 / 33-H01PP	MK-445-100-225-6200-900	M83513 / 33-H02PP	MK-445-100-235-6200-900	M83513 / 33-H03PP	MK-445-100-245-6200-900
M83513 / 33-H01PT	MK-445-100-225-0000-0B7	M83513 / 33-H02PT	MK-445-100-235-0000-0B7	M83513 / 33-H03PT	MK-445-100-245-0000-0B7
M83513 / 33-H01PW	MK-445-100-225-6200-0B7	M83513 / 33-H02PW	MK-445-100-235-6200-0B7	M83513 / 33-H03PW	MK-445-100-245-6200-0B7

X-ON Electronics

Largest Supplier of Electrical and Electronic Components

Click to view similar products for [D-Sub Backshells](#) category:

Click to view products by [AirBorn](#) manufacturer:

Other Similar products are found below :

[M85049/6-38N](#) [M85049/86-12N03](#) [M85049/90-13P03](#) [70.350.0636.4](#) [70.350.2435.1](#) [72.350.1035.2](#) [72.352.2435.1](#) [73.359.4035.3](#) [829472-1](#)
[PCS-E20W](#) [970-015-040R011](#) [970-025-040R011](#) [971-009-030R121](#) [971-009-040R011](#) [971-015-040R011](#) [1437013-9](#) [1484402-8](#) [156-3025-](#)
[EX](#) [16-500800](#) [165X02659X](#) [165X03329A](#) [165X03399A](#) [165X10259X](#) [165X11759X](#) [165X11889X](#) [165X13019X](#) [165X13029X](#)
[165X13169X](#) [165X13199X](#) [165X13239X](#) [165X13389X](#) [165X13489X](#) [165X14219X](#) [165X14449X](#) [165X17409X](#) [165X17439X](#)
[165X17569X](#) [165X17599X](#) [165X17609X](#) [165X17889X](#) [165X17979X](#) [L171373](#) [971-025-030R121](#) [300X10989X](#) [165X02609X](#)
[165X02639X](#) [165X02689X](#) [165X04219A](#) [165X10469X](#) [165X11279X](#)