



High-Reliability Interconnect Solutions



# M Series

Microminiatures — 0.050" (1.27mm)



# Contents

## "M" Series

### .050" Microminiature PCB and I/O Connectors

M-1	Index
M-5	Contents
M-6	Specifications
M-7	Performance
M-8	Part number description
M-9	Mating matrix

### Micro-Strip Connectors (Plastic)

M-11	MA-1	1-row, cable to cable
M-13	MA-1	1-row, board to cable
M-15	MA-1	1-row, MA strip guidelines
M-16	MA-1	1-row, board layouts
M-23	MA-2	2-row, cable to cable
M-25	MA-2	2-row, board to cable
M-28	MA-2	2-row, MA strip guidelines
M-29	MA-2	2-row, board layouts

### Micro-D Cable to Cable Connectors (Metal and Plastic)

M-35	MM-MM, MN-MN	Rugged
M-36.1	MM	Rugged, Grounding Fingers
M-36.3	MM	Rugged, Integrated Shield Termination - Stranded Wire
M-36.5	MM	Rugged, Integrated Shield Termination - Stranded Wire
M-37	MM, MN	Rugged, Jumper Assembly
M-39	MQ-MQ, MP-MP	Low Profile
M-41	MQ, MP	Low Profile, Jumper Assembly
M-43	MK, ML	Rugged Right Angle, Narrow Footprint
M-45	MK	Rugged Right Angle, Thru Clearance
M-47	MK	Rugged Right Angle, Blind Clearance
M-49	MK, ML	Rugged, Flex Cable
M-51	MS, MR	Low Profile Right Angle, Narrow Footprint
M-53	MS	Low Profile Right Angle, Blind Clearance
M-55	MS, MR	Low Profile, Flex Cable
M-57	MK, ML, MS, MR	Board Layouts - Right Angle Narrow Footprint
M-60.1	MK	Rugged Right Angle, Compressed Footprint
M-60.3	MK	Board Layouts - Right Angle Compressed Footprint
M-61, M-63	MK-MM, ML-MN	Rugged Right Angle, Standard Footprint
M-65	MK, ML	Board Layouts - Right Angle Standard Footprint
M-67, M-69	MK-MM, ML-MN	Rugged Straight, Narrow Footprint
M-71	MK, ML	Board Layouts - Straight Narrow Footprint
M-73, M-75	MK-MM, ML-MN	Rugged Straight, Standard Footprint
M-77	MK, ML	Board Layouts - Standard Narrow Footprint

### Micro-D Surface Mount Board to Cable Connectors

M-81	MM, MN	Specifications, SMT Connectors
M-82	MM, MN	Performance, SMT Connectors
M-83, 85	MM-MM, MN-MN	Rugged Horizontal SMT
M-87	MM, MN	Board layouts - Rugged Horizontal SMT
M-89, 91	MK-MM	Rugged Vertical SMT
M-93	MK	Board layouts - Rugged Vertical SMT
M-95, 97	MK-MM	Rugged Card Edge Mount
M-99	MK	Board layouts - Rugged Card Edge Mount

### Micro-D Filtered Cable Connectors

M-103	MF	Rugged metal
-------	----	--------------

### Micro-D Hybrid Connectors

M-105	MM	Specifications, Rugged Hybrid Connectors
M-106	MM	Performance, Rugged Hybrid Connectors
M-107	MM	Rugged Hybrid

### Micro-Circular Connectors

M-109	MC-MC	Rugged metal, quick release
-------	-------	-----------------------------

### Micro-D Rear Panel Mount Connectors

M-111	MK-MM, MK-MN	Specifications, Rear Panel Mount
M-112	MK-MM, MK-MN	Performance, Rear Panel Mount
M-113, 115	MM, MN	Rugged, Cable to Cable Rear Panel Mount
M-117, 119	MK-MM, MK-MN	Rugged, Board to Cable Rear Panel Mount
M-121	MK	Board Layouts - Straight, Standard Footprint
M-122.1	MK	Rugged Right Angle, Rear Panel Mount
M-122.3	MK	Board Layouts - Rugged Right Angle

### Micro-D Sealed Connectors

M-123	MM	Specifications, Sealed
M-124	MM	Performance, Sealed
M-125	MM	Rugged, Metal I/O Sealed



**"M" SERIES - .050"**  
**MIL-DTL-83513**  
**See pages M-5 thru M-126**

**"MHT" SERIES - .050"**  
**High Temperature**  
**See pages MHT-1 thru MHT-24**

**"M" SERIES ACCESSORIES**  
**See pages MA-1 thru MA-25**

**MILITARY CROSS REFERENCE**  
**See pages MIL-1 thru MIL-22**

**Micro-Strip  
Connectors  
Cable to Cable**

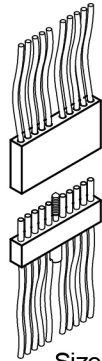

**1 Row**  
Sizes: 3 thru 60  
Page: M-11

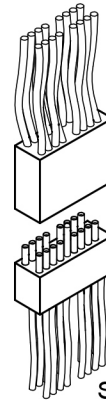

**2 Row**  
Sizes: 4 thru 128  
Page: M-23

**Micro-Strip  
Connectors  
Board to Cable**

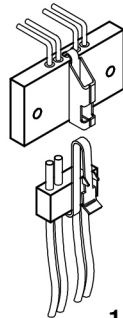

**1 Row**  
Sizes: 3 thru 60  
Page: M-13

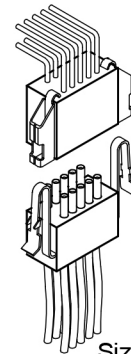

**2 Row**  
Sizes: 4 thru 128  
Page: M-25

**Micro-D  
Connectors  
Cable to Cable**

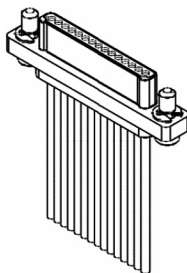

Single Row Micro  
Sizes: 4 thru 25  
Page: M-127

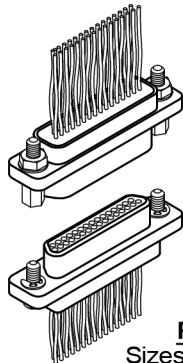

**Rugged**  
Sizes: 9 thru 100  
Page: M-35  
High Temperature Sizes: 9 thru 100  
Page: MHT-7

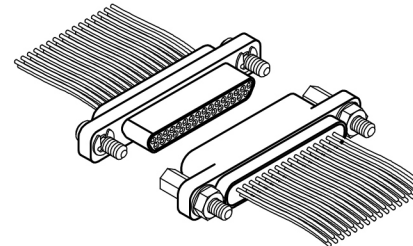

**Low Profile**  
Sizes: 9 thru 51  
Page: M-39  
High Temperature Sizes: 9 thru 51  
Page: MHT-9

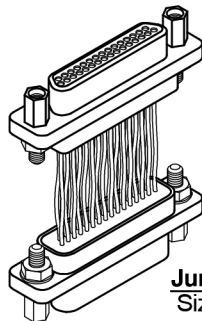

**Rugged,  
Jumper Assembly**  
Sizes: 9 thru 100  
Page: M-37

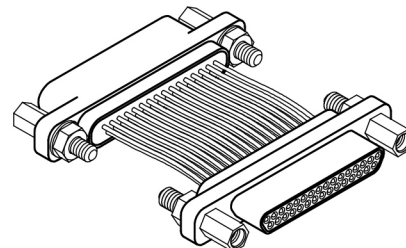

**Low Profile, Jumper Assembly**  
Sizes: 9 thru 51  
Page: M-41

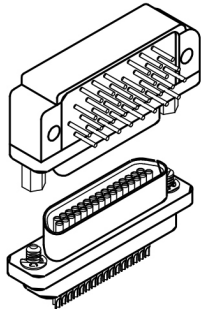

**Rugged Right Angle,  
Narrow Footprint**  
 Sizes: 9 thru 100  
 Pages: M-43 & M-48  
 High Temperature Sizes: 9 thru 100  
 Pages: MHT-11 & MHT-13

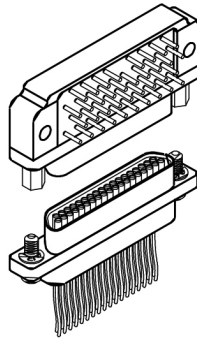

**Low Profile Right Angle,  
Narrow Footprint**  
 Sizes: 9 thru 51  
 Pages: M-51 & M-54  
 High Temperature Sizes: 9 thru 51  
 Pages: MHT-17 & MHT-19

**Micro-D  
Connectors  
Board to Cable**

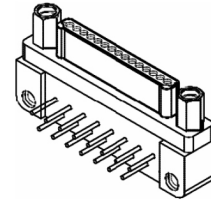

Single Row Micro  
 Sizes: 4 thru 25  
 Page: M-129

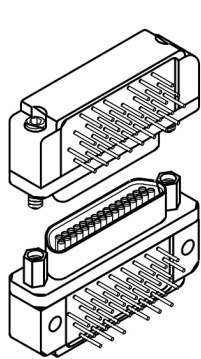

**Rugged, Flex Cable**  
 Sizes: 9 thru 100  
 Page: M-49

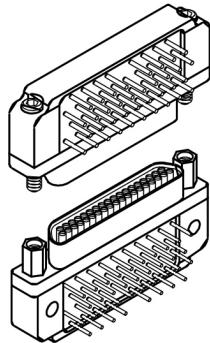

**Low Profile, Flex Cable**  
 Sizes: 9 thru 51  
 Page: M-55

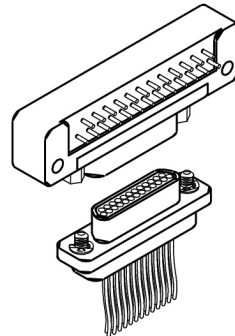

**Rugged Right Angle,  
Standard Footprint**  
 Sizes: 9 thru 100  
 Pages: M-61 & M-63

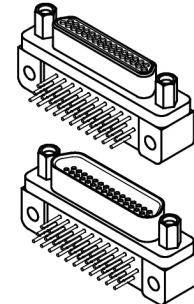

**Rear Panel Mount  
Compressed Footprint**  
 Sizes: 9 thru 100  
 Pages: M-60.1 & M-60.4

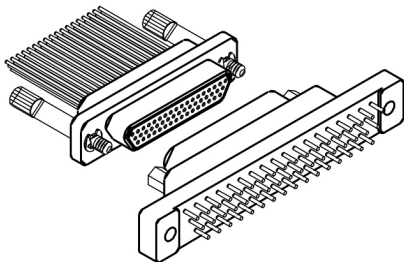

**Rugged Straight,  
Narrow Footprint**  
 Sizes: 9 thru 100  
 Pages: M-67 & M-69

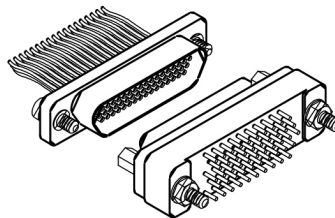

**Rugged Straight,  
Standard Footprint**  
 Sizes: 9 thru 100  
 Pages: M-73 & M-75

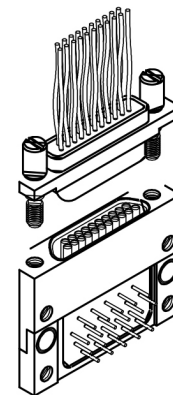

**Low Profile, Radius Shell**  
 High Temperature Sizes: 9 thru 51  
 Page: MHT-23

**Micro-D  
Connectors  
Surface Mount  
Board to Cable**

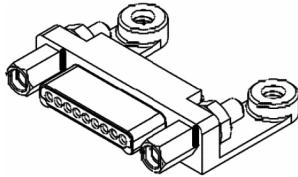

**Sing Row Micro**  
Sizes 4 thru 25  
Pages: M-133

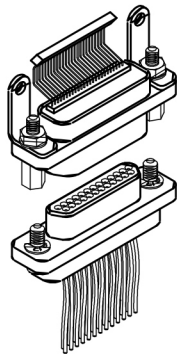

**Rugged Horizontal,  
Surface Mount**  
Sizes: 9 thru 51  
Pages: M-83 & M-85

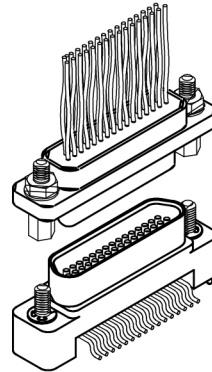

**Rugged Vertical,  
Surface Mount**  
Sizes: 9 thru 51  
Pages: M-89 & M-91

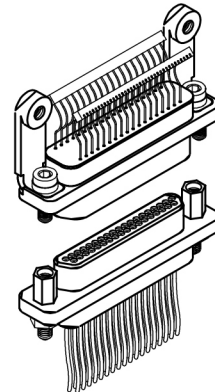

**Rugged  
Card Edge Mount**  
Sizes: 9 thru 100  
Pages: M-95 & M-97

**Micro-D  
Connectors  
Filtered Cable**

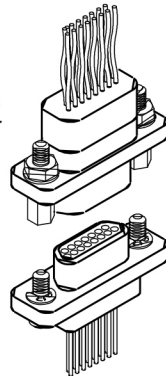

**Rugged Filtered**  
Sizes: 9 thru 37  
Page: M-103

**Micro-D  
Connectors  
Hybrid Cable**

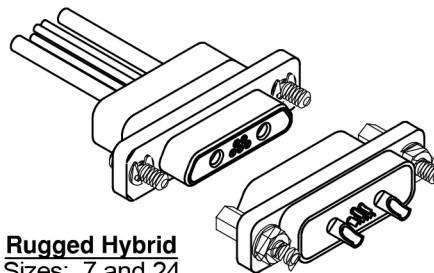

**Rugged Hybrid**  
Sizes: 7 and 24  
Page: M-107

**Circular Cable  
Connectors**

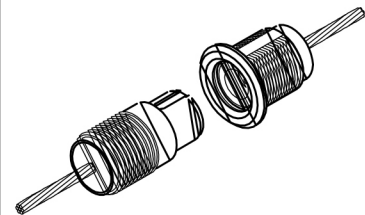

**Circular**  
Sizes: 7 & 19  
Page: M-109

**Micro-D  
Connectors  
Rear Panel  
Mount**

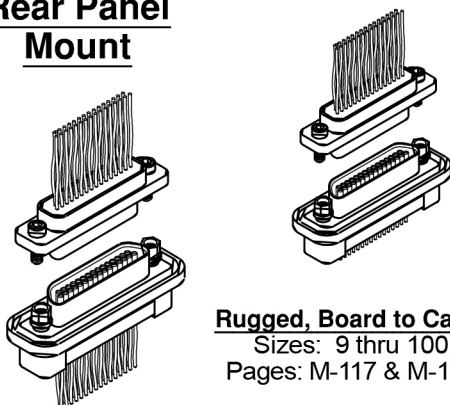

**Rugged, Cable to Cable**  
Sizes: 9 thru 100  
Pages: M-113 & M-115

**Rugged, Board to Cable**  
Sizes: 9 thru 100  
Pages: M-117 & M-119

**Right Angle  
Boardmount**

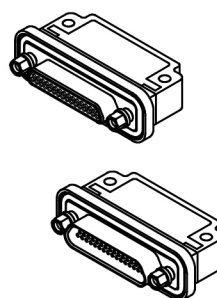

**Rear Panel Mount**  
Sizes: 9 thru 100  
Page: M-122.1 & M-122.4

**Micro-D  
Connectors  
Sealing**

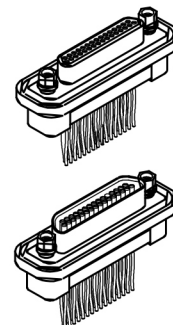

**Rugged, I/O**  
Sizes: 9 thru 100  
Page: M-125

**Micro-D  
Connectors  
Grounding  
Fingers**

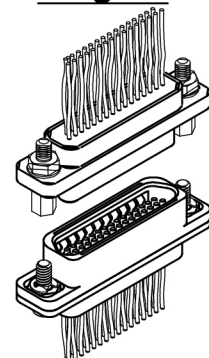

**Rugged, I/O**  
Sizes: 9 thru 100  
Page: M-36.1

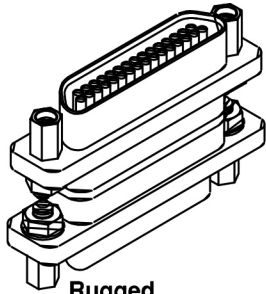

**Rugged**  
 Sizes: 9 thru 100  
 Page: MA-11

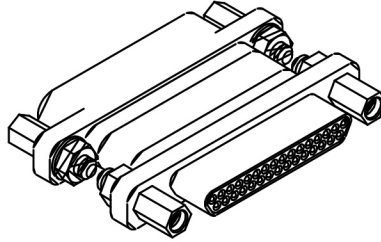

**Low Profile**  
 Sizes: 9 thru 51  
 Page: MA-13

**Micro-D  
 Connectors  
 Connector Savers**

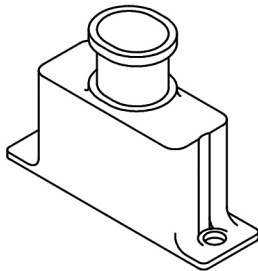

**Rugged**  
 Page MA-15

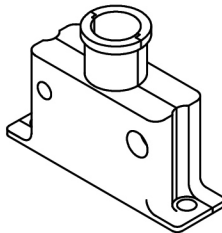

**Low Profile**  
 Page MA-21

**EMI / RFI Straight  
 Backshells**

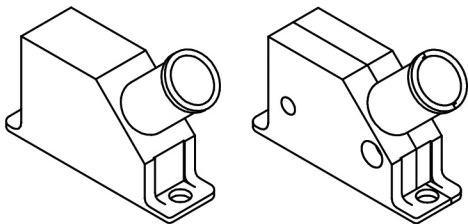

**Rugged**  
 Page MA-17

**Micro-D  
 EMI / RFI 45°  
 Backshells**

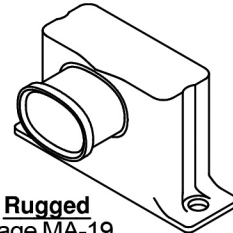

**Rugged**  
 Page MA-19

**Micro-D  
 EMI / RFI 90°  
 Backshells**

**Integral Shield  
 Termination**

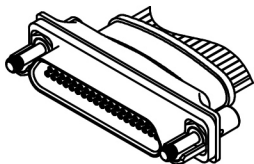

**Rugged**  
 Page M-36.3

**Integral Shield  
 Termination  
 with Solder Cups**

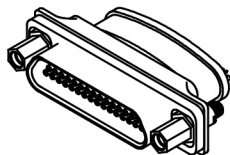

**Rugged**  
 Page M-36.5

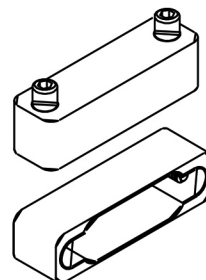

**Rugged**  
 Page MA-23

**Dust  
 Covers**

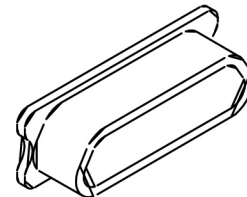

**ESD  
 Rugged & Low Profile**  
 Page MA-25

**"M" SERIES - .050"**  
**MIL-DTL-83513**

## Specifications

### Materials and Finishes \*

<b>Contacts:</b>	Pins: BeCu alloy strip per ASTM B194 Sockets: Brass per ASTM B121 / B121M or ASTM B16 / B16M or ASTM B453
<b>Contact Finish:**</b>	Gold plate per ASTM B488
<b>Shells:</b>	Aluminum Alloy 6061-T6 per SAE AMS-QQ-A-250/11 or 6061-T6511 per SAE AMS-QQ-A-200/8 or Stainless Steel 300 series per ASTM A484 / A484M and ASTM A582 / A582M Passivated per SAE AMS2700
<b>Aluminum Shell Finishes:**</b>	Electroless Nickel per SAE AMS2404, Class 3, 500 $\mu$ " min Electrodeposited Cadmium per SAE AMS-QQ-P-416, Type II, Class 3 Black Anodized per MIL-A-8625, Type III, Class 2 Gold per MIL-DTL-45204, Type II, Grade C, Class 0 Zinc Nickel Alloy per ASTM B841, Class 1 Pure Electrodeposited Aluminum per MIL-DTL-83488, type 2 High Phosphorus Nickel with Fluorocarbon Polymer additive per SAE AMS2454, Grade 2E, Type V (9% MIN Phosphorus content by weight)
<b>Molded Insulators:</b>	Glass filled polyphenylene sulfide per MIL-M-24519
<b>Embedment:</b>	Frey Engineering Co. insulating compound CF3003-80 and L-II-49 or equivalent
<b>Jackscrows, Jackposts and Nuts:</b>	Corrosion resistant steel per ASTM A320 or ASTM A484 / A484M and ASTM A582 / A582M Passivated per SAE AMS2700
<b>Clips and Washers:</b>	Corrosion resistant steel per ASME 18.24 or NASM35333 or ASTM A484/A484M and ASTM A582/A582M (For reference only: ASME 18.24 CRS per ASTM A693 and NASM35333 CRS per ASTM A240) Passivated per ASME 18.24 or NASM35333 or SAE AMS2700 (For reference only: ASME 18.24 and NASM35333 passivated per SAE AMS2700)
<b>Guide Pins</b>	Corrosion resistant steel per ASTM A484 / A484M and ASTM A582 / A582M Passivated per SAE AMS2700
<b>Latches</b>	Beryllium copper in accordance with ASTM B194 Electroless Nickel plate per SAE AMS2404
<b>Interfacial Seal Gaskets:</b>	Fluorosilicone per MIL-DTL-25988
<b>Tolerances:**</b>	Unless otherwise specified: Fractions = $\pm 1/64$ " Decimals = $\pm .010$ " Angles = $\pm 5^\circ$ Wire lengths: insulated/stranded = $+1.0"/-0.0$ " uninsulated/solid = $+0.2"/-0.0$ "

Note: AirBorn can manufacture special configurations for your exact specifications.

\* = Reference the above listed specifications or an equivalent industry standard when applicable

\*\* = When ordering to Mil Spec P/N, Mil Spec requirements apply



## Performance Reference MIL-DTL-83513

AirBorn "M" Series meets or exceeds MIL-DTL-83513 Performance Specifications

<b>Contact Rating:</b>	3-amperes maximum
<b>Solderability:</b>	Terminals (except crimp) tested in accordance with MIL-STD-202, Method 208
<b>Wire Size:</b>	Stranded #26 AWG or solid #25 AWG standard (consult factory for other sizes and types)
<b>Test Voltage:</b>	600 V, RMS, 60 Hz
<b>Operating Temperature:</b>	-55° C to +125° C
<b>Insulation Resistance:</b>	5,000 megohms minimum @ 500 VDC
<b>Durability:</b>	500 connector mating cycles
<b>Vibration:</b>	Tested in accordance with MIL-STD-1344, Method 2005, Condition IV, according to MIL-83513
<b>Shock:</b>	Tested in accordance with MIL-STD-1344, Method 2004, Condition E, according to MIL-83513
<b>Salt Spray:</b>	Mated connectors tested in accordance with MIL-STD-1344, Method 1001, Test Condition B
<b>Humidity:</b>	Mated connectors tested in accordance with MIL-STD-1344, Method 1002, Type II (except steps 7a and 7b)
<b>Thermal Shock:</b>	Tested to the temperature extremes of MIL-STD-1344, Method 1003, Test Condition A (except step 3, temperature shall be 125° C)
<b>Contact Resistance:</b>	0.065 volt maximum drop @ 2.5 amps (.026 ohms)
<b>Contact Engaging Force:</b>	6.0 ounce maximum, with .0221 diameter test sleeve per contact
<b>Contact Separating Force:</b>	0.5 ounce minimum, with .0230 diameter test sleeve per contact
<b>Crimp Strength:</b>	5 pound minimum tensile strength
<b>Mating &amp; Unmating Force:</b>	10 ounces maximum per contact



## Part Number Description

Each part number consists of at least five elements: series, body description, size (number of contacts), type of contacts, and type of hardware. A sixth element is added whenever special modifications or options are available.

Each catalog page shows the choices available for each of these elements. By selecting one option from each category on the page, you can build a set of connectors to meet your requirements.

Each element is identified by a combination of letters and/or numbers in fixed field lengths, and separated by a hyphen (-). Each space must be filled in to complete the number. When the size, for example, is less than 100, indicate as 009, 051, etc.

### **Series:**

This will always be a two letter designator, and will identify the connector series. All .050" connectors begin with the letter "M". The second letter designates the various styles of .050" connectors.

### **Body:**

Each digit of the Body Designator will normally identify (1) the number of rows, (2) the style of body, and (3) the body materials. The three digit number to identify the body consists of one digit from each group.

### **Size:**

The size is determined by the number of contacts in the connector, and is an integral part of the part number. Order only sizes shown on the catalog page unless otherwise noted.

### **Contacts:**

Each page also identifies all contact options for a given connector. The first two digits designate the type of contacts and terminations; the third digit designates the plating option.

### **Hardware:**

The hardware designator is four digits; two for style of hardware and two for polarization or wiring instruction. Follow the choices for each connector.

### **Special Instructions (Options):**

Special instructions are referenced by a three or four digit number added to the end of the part number. The last three or four digits are included only when applicable. AirBorn will provide individual code numbers as needed.

### **Note:**

Each page is as comprehensive as possible. However, if you do not find a particular connector size or option, please contact the factory for further assistance.

Symbolizes options that are not RoHS compliant.



## Mating Matrix for AirBorn "M" Series Connectors

### RECEPTACLES

P L U G S	MA (Strip)	MC (Circular)	MM (Hybrid)	MK (Metal) PC Board	ML (Plastic) PC Board	MM (Metal) I/O	MN (Plastic) I/O	MP (Plastic) I/O	MQ (Metal) I/O	MR (Plastic) PC Board	MS (Metal) PC Board	
	MA (Strip)	XX										
	MC (Circular)		XX									
	MM (Hybrid)			XX								
	MK (Metal) PC Board				BB	BB	BI	BI				
	ML (Plastic) PC Board				BB	BB	BI	BI				
	MM (Metal) I/O				IB	IB	II	II				
	MN (Plastic) I/O				IB	IB	II	II				
	MP (Plastic) I/O								II	II	IB	IB
	MQ (Metal) I/O								II	II	IB	IB
	MR (Plastic) PC Board								BI	BI	BB	BB
	MS (Metal) PC Board								BI	BI	BB	BB

I/O Connectors

MM-MN-MP-MQ

PC Board Mounted Connectors

MK-ML-MR-MS

Inter-mateable Connectors

MK-ML-MM-MN  
MP-MQ-MR-MS

#### KEY:

BB = PC Board Mounted Plug with PC Board Mounted Receptacle

BI = PC Board Mounted Plug with I/O Receptacle

IB = I/O Plug with PC Board Mounted Receptacle

II = I/O Plug with I/O Receptacle

For Military Configurations, See pages MIL-1 thru MIL-22





# 1 • ROW Strip Connectors Cable to Cable

.050"

**MA-1**

2 thru 60 Contacts

MA-131-010-161-A69WQ

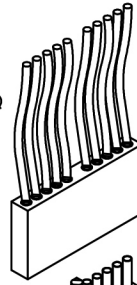

MA-141-010-261-A72WQ

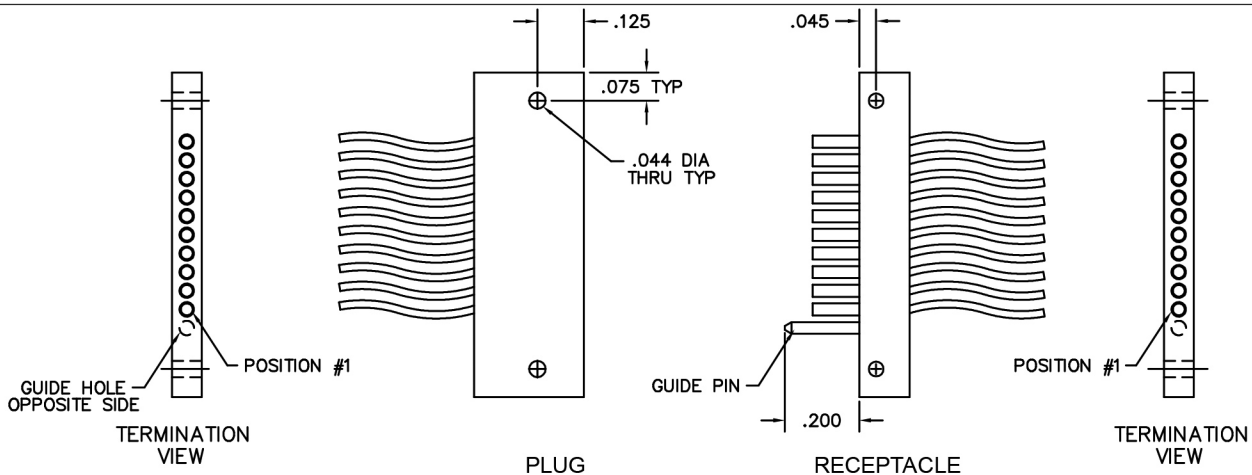
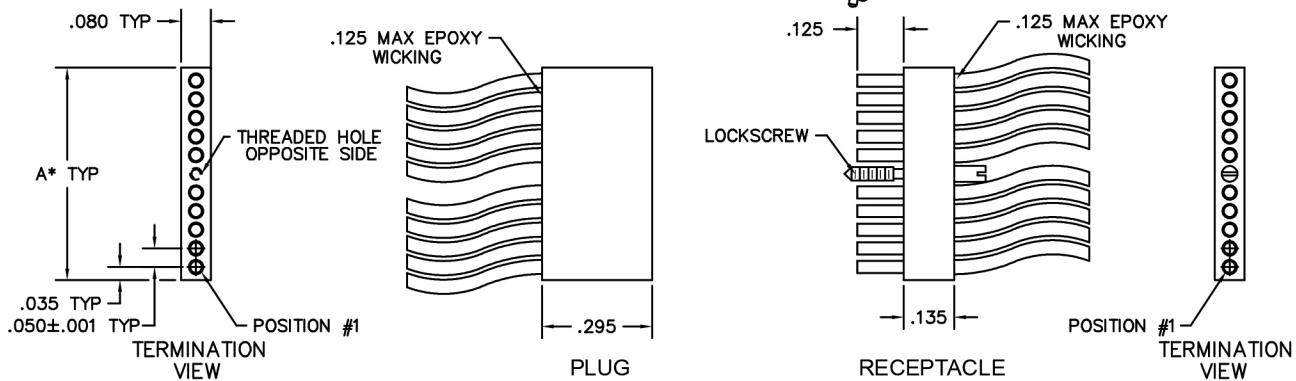
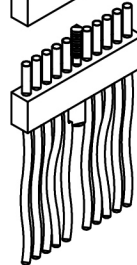

### OPTIONAL MOUNTING HOLES & GUIDE PIN

DIMENSIONS	
To determine connector length (Dim "A"):	
Multiply the number of cavities in one row by .050"	..... "
Add fixed end lengths (constant, .010" x 2)	..... 0.02"
Add .150" for each mounting hole	..... "
Total Length:	..... "

Notes:  
 Length over 2" may require support to insure alignment.  
 When using one lock screw, use centermost available hole.  
 \* = Maximum length is 3.020". Maximum number of contacts must be reduced to accommodate hardware and mounting holes.



PLUG: MA-131-010-161-A69WQ  
 RECEPTACLE: MA-141-010-261-A72WQ  
 XX-XXX-XXX-XXX-XXXXX

PLUG		RECEPTACLE	
<b>SERIES</b>			
MA .050" Microminiature Strip Connector		MA .050" Microminiature Strip Connector	
<b>BODY</b>			
1 1-Row		1 1-Row	
BODY STYLE: (Material: Polyphenylene sulfide)		BODY STYLE: (Material: Polyphenylene sulfide)	
11 Plug, straight, with mounting holes		21 Receptacle, straight, with mounting holes	
31 Plug, straight, without mounting holes		41 Receptacle, straight, without mounting holes	
<b>SIZE</b>			
XXX 002 - 060		XXX 002 - 060	
Note: Maximum number of contacts is reduced when using hardware or mounting holes. See dimension chart on M-11.			
<b>CONTACTS</b>			
TYPE CONTACTS/TERMINATIONS:		TYPE CONTACTS/TERMINATIONS:	
11 Pin, straight, solder cup		21 Socket, straight, solder cup	
14 Pin, straight, .500" pigtails (.018 dia)		24 Socket, straight, .500" pigtails (.018 dia)	
15 Pin, straight, 1.000" pigtails (.018 dia)		25 Socket, straight, 1.000" pigtails (.018 dia)	
16 Pin, straight, crimped wire		26 Socket, straight, crimped wire	
PLATING OPTIONS:		PLATING OPTIONS:	
1 50 μ" Au contacts (crimp wire)		1 50 μ" Au contacts (crimp wire)	
3 50 μ" Au contacts; 10 μ" Au terminations (solder cup, pigtail)		3 50 μ" Au contacts; 10 μ" Au terminations (solder cup, pigtail)	
5 50 μ" Au contacts; Sn/Pb alloy terminations (pigtail) <input checked="" type="checkbox"/>		5 50 μ" Au contacts; Sn/Pb alloy terminations (pigtail) <input checked="" type="checkbox"/>	
7 50 μ" Au contacts; SAC305 terminations (pigtail)		7 50 μ" Au contacts; SAC305 terminations (pigtail)	
<b>HARDWARE</b>			
STYLE OF HARDWARE:		STYLE OF HARDWARE:	
A00 None		A00 None	
A01-A49 Latch box, side mounted (cavity number location)		A01-A49 Latch spring, side mounted (cavity number location)	
A50 Latch boxes (two end cavities)		A51 Latch springs (two end cavities)	
A64 One guide hole (centered)*		A61 One guide pin (centered)*	
A65 One guide hole (first cavity)		A62 One guide pin (first cavity)	
A66 One guide hole (last cavity)		A63 One guide pin (last cavity)	
A68 Two guide holes (two end cavities)		A67 Two guide pins (two end cavities)	
A69 One threaded hole (centered)*		A72 One lockscrew (centered)*, uninstalled	
AHX One guide hole (cavity #2 - #9)		APX One guide pin (cavity #2 - #9)	
ATX One threaded hole (cavity #2 - #9)		ALX One lockscrew (cavity #2 - #9), uninstalled	
POLARIZATION / WIRING:		POLARIZATION / WIRING:	
00 None		00 None	
XX For wiring codes, see pages MA-3 & MA-4		XX For wiring codes, see pages MA-3 & MA-4	

\* = To determine location, divide the total number of cavities by two and round to the next whole number, if result is a fraction. See page M-15. See MA strip guidelines, page M-15, for location examples & visual clarification.

= Option not RoHS compliant

## 1 • ROW Strip Connectors Board to Cable

.050"

**MA-1**

2 thru 60 Contacts

MA-1D1-004-325-A0300

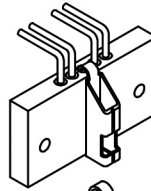

MA-141-004-261-A03WS

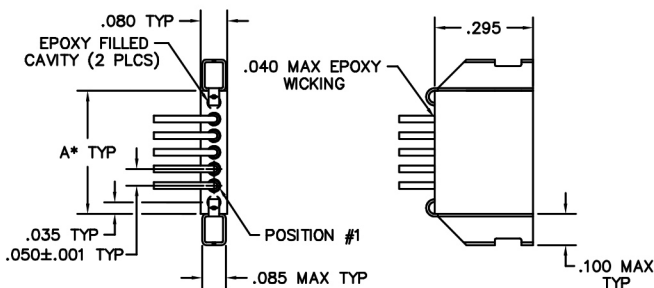

TERMINATION VIEW

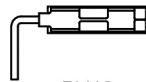

PLUG

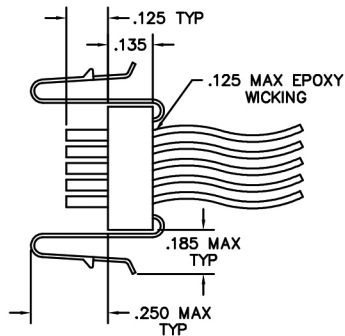

RECEPTACLE

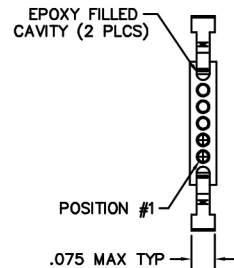

TERMINATION VIEW

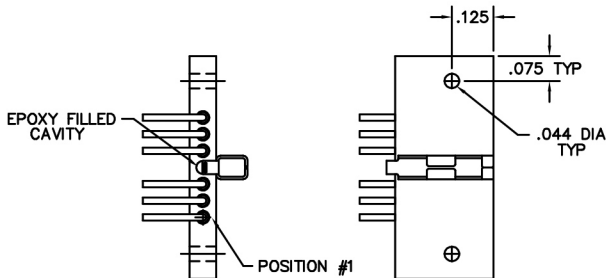

TERMINATION VIEW

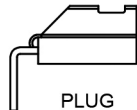

PLUG

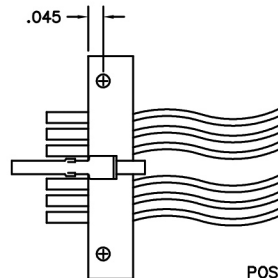

RECEPTACLE

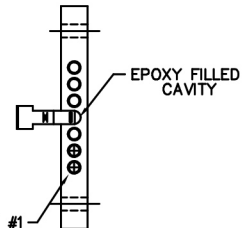

TERMINATION VIEW

### OPTIONAL MOUNTING HOLES

#### DIMENSIONS

To determine connector length (Dim "A"):	
Multiply the number of cavities in one row by .050"	..... "
Add fixed end lengths (constant, .010" x 2)	..... 0.02"
Add .150" for each mounting hole	..... "
Total Length:	..... "

#### Notes:

Length over 2" may require support to insure alignment.  
When using one lock screw, use centermost available hole.  
\* = Maximum length is 3.020". Maximum number of contacts must be reduced to accommodate hardware and mounting holes.

**LEAD CONFIGURATION OPTIONS**

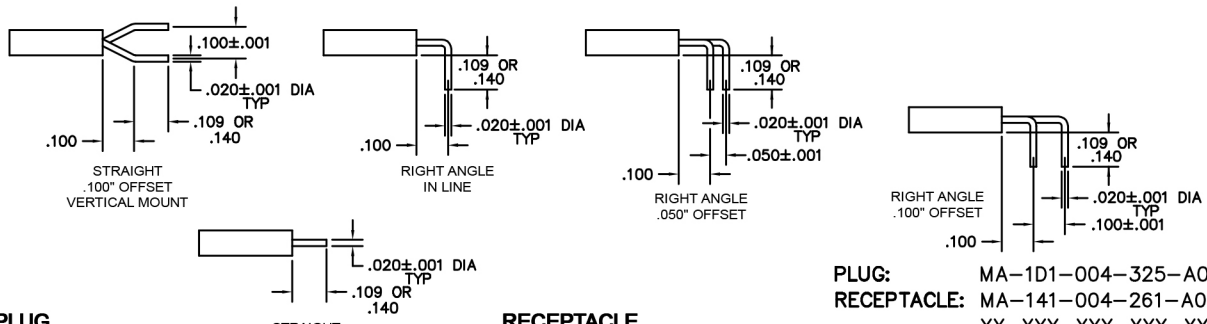

**PLUG:** MA-1D1-004-325-A0300  
**RECEPTACLE:** MA-141-004-261-A03WS  
 XX-XXX-XXX-XXX-XXXXX

<b>PLUG</b>		<b>RECEPTACLE</b>	
<b>SERIES</b>			
MA .050" Microminiature Strip Connector		MA .050" Microminiature Strip Connector	
<b>BODY</b>			
1 1-Row	1 1-Row	1 1-Row	1 1-Row
BODY STYLE: (Material: Polyphenylene sulfide)		BODY STYLE: (Material: Polyphenylene sulfide)	
11 Plug, straight, with mounting holes	21 Receptacle, straight, with mounting holes	41 Receptacle, straight, without mounting holes	61 Receptacle, right angle, .050" offset, with mounting holes
31 Plug, straight, without mounting holes	41 Receptacle, straight, without mounting holes	81 Receptacle, right angle, .100" offset, with mounting holes	A1 Receptacle, right angle, .050" offset, without mounting holes
51 Plug, right angle, .050" offset, with mounting holes	61 Receptacle, right angle, .050" offset, with mounting holes	81 Receptacle, right angle, .100" offset, with mounting holes	C1 Receptacle, right angle, .100" offset, without mounting holes
71 Plug, right angle, .100" offset, with mounting holes	81 Receptacle, right angle, .100" offset, with mounting holes	E1 Receptacle, right angle, in line, with mounting holes	G1 Receptacle, right angle, in line, without mounting holes
91 Plug, right angle, .050" offset, without mounting holes	A1 Receptacle, right angle, .050" offset, without mounting holes	J 1 Receptacle, straight, .100" offset, without mounting holes	
B1 Plug, right angle, .100" offset, without mounting holes	C1 Receptacle, right angle, .100" offset, without mounting holes		
D1 Plug, right angle, in line, with mounting holes	E1 Receptacle, right angle, in line, with mounting holes		
F1 Plug, right angle, in line, without mounting holes	G1 Receptacle, right angle, in line, without mounting holes		
H1 Plug, straight, .100" offset, without mounting holes	J 1 Receptacle, straight, .100" offset, without mounting holes		
<b>SIZE</b>			
XXX 002 - 060		XXX 002 - 060	
Note: Maximum number of contacts is reduced when using hardware or mounting holes. See dimension chart on M-13.			
<b>CONTACTS</b>			
TYPE CONTACTS/TERMINATIONS:		TYPE CONTACTS/TERMINATIONS:	
11 Pin, straight, solder cup	21 Socket, straight, solder cup	22 Socket, straight, PCB leads, .109"	23 Socket, straight, PCB leads, .140"
12 Pin, straight, PCB leads, .109"	22 Socket, straight, PCB leads, .109"	24 Socket, straight, .500" pigtails (.018 dia)	25 Socket, straight, 1.000" pigtails (.018 dia)
13 Pin, straight, PCB leads, .140"	23 Socket, straight, PCB leads, .140"	26 Socket, straight, crimped wire	43 Socket, right angle, PCB leads, .109"
14 Pin, straight, .500" pigtails (.018 dia)	24 Socket, straight, .500" pigtails (.018 dia)	44 Socket, right angle, PCB leads, .140"	
15 Pin, straight, 1.000" pigtails (.018 dia)	25 Socket, straight, 1.000" pigtails (.018 dia)		
16 Pin, straight, crimped wire	26 Socket, straight, crimped wire		
32 Pin, right angle, PCB leads, .109"	43 Socket, right angle, PCB leads, .109"		
33 Pin, right angle, PCB leads, .140"	44 Socket, right angle, PCB leads, .140"		
PLATING OPTIONS:		PLATING OPTIONS:	
1 50 μ" Au contacts (crimp wire)	1 50 μ" Au contacts (crimp wire)	3 50 μ" Au contacts; 10 μ" Au terminations (solder cup, pigtail, PCB leads)	5 50 μ" Au contacts; Sn/Pb alloy terminations (dip solder, pigtail, PCB leads) ☒
3 50 μ" Au contacts; 10 μ" Au terminations (solder cup, pigtail, PCB leads)	3 50 μ" Au contacts; 10 μ" Au terminations (solder cup, pigtail, PCB leads)	7 50 μ" Au contacts; SAC305 terminations (pigtail, PCB leads)	7 50 μ" Au contacts; SAC305 terminations (pigtail, PCB leads)
5 50 μ" Au contacts; Sn/Pb alloy terminations (dip solder, pigtail, PCB leads) ☒	5 50 μ" Au contacts; Sn/Pb alloy terminations (dip solder, pigtail, PCB leads) ☒		
7 50 μ" Au contacts; SAC305 terminations (pigtail, PCB leads)	7 50 μ" Au contacts; SAC305 terminations (pigtail, PCB leads)		
<b>HARDWARE</b>			
STYLE OF HARDWARE:		STYLE OF HARDWARE:	
A00 None	A00 None	A01-A49 Latch box, side mounted (cavity number location)	A51 Latch springs (two end cavities)**
A01-A49 Latch box, side mounted (cavity number location)	A01-A49 Latch spring, side mounted (cavity number location)	A64 One guide hole (centered)*	A62 One guide pin (first cavity)
A50 Latch boxes (two end cavities)**	A51 Latch springs (two end cavities)**	A65 One guide hole (first cavity)	A63 One guide pin (last cavity)
A64 One guide hole (centered)*	A61 One guide pin (centered)*	A66 One guide hole (last cavity)	A67 Two guide pins (two end cavities)
A65 One guide hole (first cavity)	A62 One guide pin (first cavity)	A68 Two guide holes (two end cavities)	A72 One lockscrew (centered)*
A66 One guide hole (last cavity)	A63 One guide pin (last cavity)	A69 One threaded hole (centered)*	APX One guide pin (cavity #2 - #9)
A68 Two guide holes (two end cavities)	A67 Two guide pins (two end cavities)	AHX One guide hole (cavity #2 - #9)	ALX One lockscrew (cavity #2 - #9)
A69 One threaded hole (centered)*	A72 One lockscrew (centered)*	ATX One threaded hole (cavity #2 - #9)	
AHX One guide hole (cavity #2 - #9)	APX One guide pin (cavity #2 - #9)		
ATX One threaded hole (cavity #2 - #9)	ALX One lockscrew (cavity #2 - #9)		
POLARIZATION / WIRING:		POLARIZATION / WIRING:	
00 None	00 None	XX For wiring codes, see pages MA-3 & MA-4	XX For wiring codes, see pages MA-3 & MA-4
XX For wiring codes, see pages MA-3 & MA-4	XX For wiring codes, see pages MA-3 & MA-4		

\* = To determine location, divide the total number of cavities by two and round to the next whole number, if result is a fraction. See page M-15.  
 \*\* = Not available with mounting holes.  
 See MA strip guidelines, page M-15, for location examples & visual clarification.  
 ☒ = Option not RoHS compliant

## 1 • ROW Strip Connectors with Latches

.050"

**MA-1**

3 thru 60 Contacts

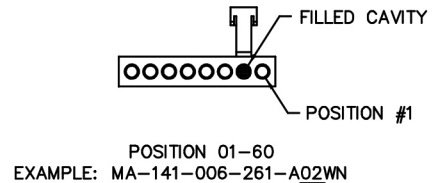
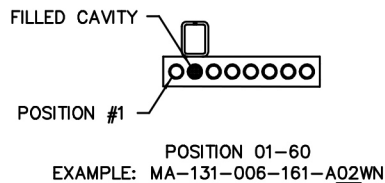
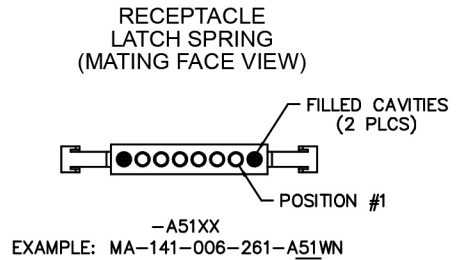
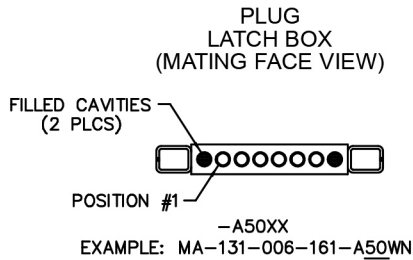

## MA Strip Guidelines

### For "A" designator in hardware portion of part number

1. Any cavity that has a contact is considered an electrical position (including dummy contact).
2. All hardware locations, holes and/or epoxy filled cavities are considered mechanical positions.
3. Omit holes on board layout for mechanical positions and renumber board layout accordingly, except connectors with mechanical position(s) in end cavity(ies).  
See board layout examples, pages M-16 thru M-22.
4. These guidelines apply for all hardware options, including guide holes (mechanical locations).
5. Do not skip wire colors on stranded wire assemblies.
6. Spacers underneath the connector are recommended when R/A PCB mount connectors with mounting holes are used and the PCB had irregularities greater than .004" underneath the connector.

#### To determine hardware location number:

1. Divide the total number of cavities by two (including hardware cavity).
2. Round to the next whole number if result is a fraction.

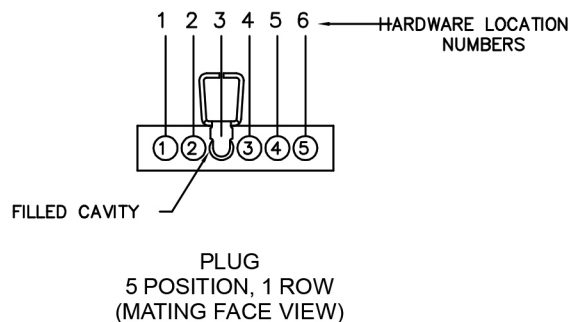

The connector above has 6 cavities with 5 live contacts.  
(5 electrical positions & 1 mechanical position)

To determine the hardware location number:  
 $6 \text{ cavities} \div 2 = 3$   
 Hardware would be placed in location #3

**Board mount connectors, right angle offset (.100") with mounting holes  
(6 electrical positions)**

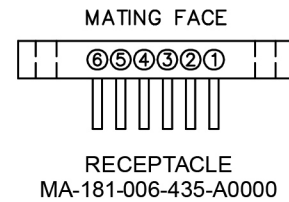
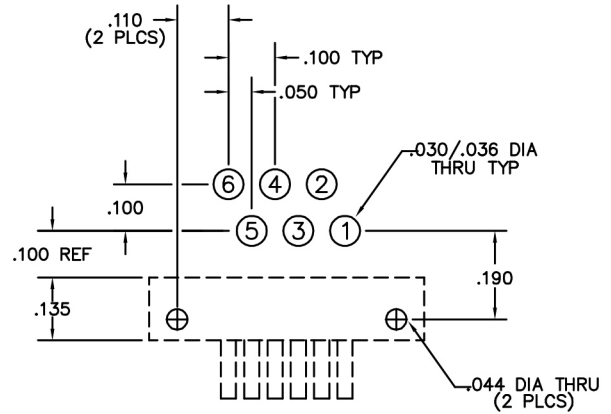
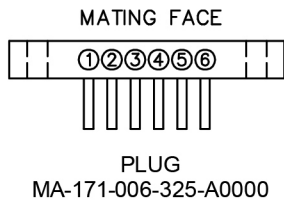
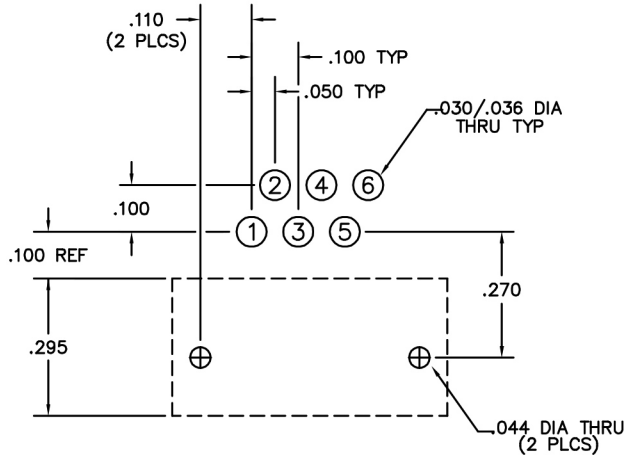

**Crimped wire connectors, straight without mounting holes  
(6 electrical positions)**

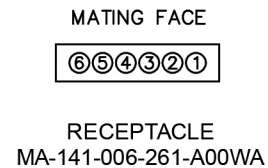
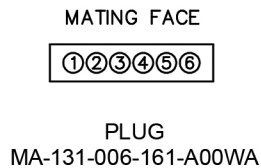

WIRE CONNECT CHART

- 1 — BLK
- 2 — BRN
- 3 — RED
- 4 — ORN
- 5 — YEL
- 6 — GRN



**Board mount connectors, right angle offset (.100") with mounting holes.  
Side mount latch, centered.**

(5 electrical positions, 1 mechanical positions)

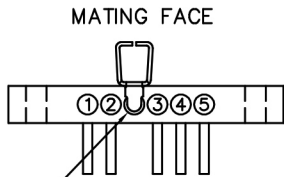
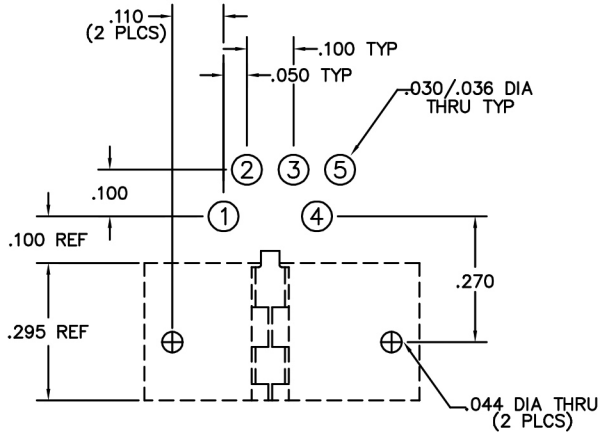

PLUG  
MA-171-005-325-A0300

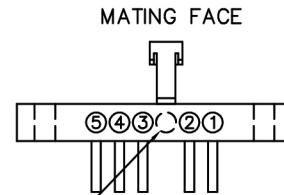
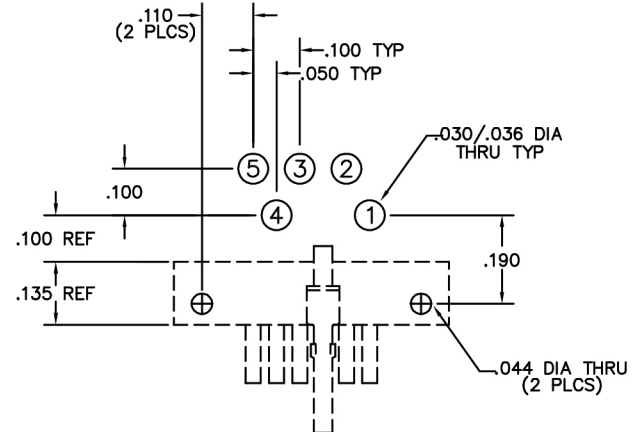

RECEPTACLE  
MA-181-005-435-A0300

**Crimped wire connectors, straight with mounting holes.  
Side mount latch, centered.**

(5 electrical positions, 1 mechanical positions)

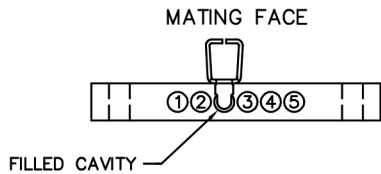

PLUG  
MA-111-005-161-A03WA

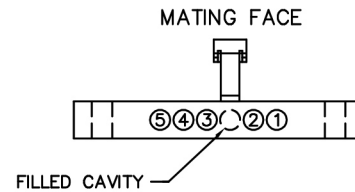

RECEPTACLE  
MA-121-005-261-A03WA

WIRE CONNECT CHART

- 1 — BLK
- 2 — BRN
- 3 — RED
- 4 — ORN
- 5 — YEL



**Board mount connectors, right angle offset (.100") without mounting holes**  
**End mount latches, 2 end cavities\***  
**(6 electrical positions, 2 mechanical positions)**

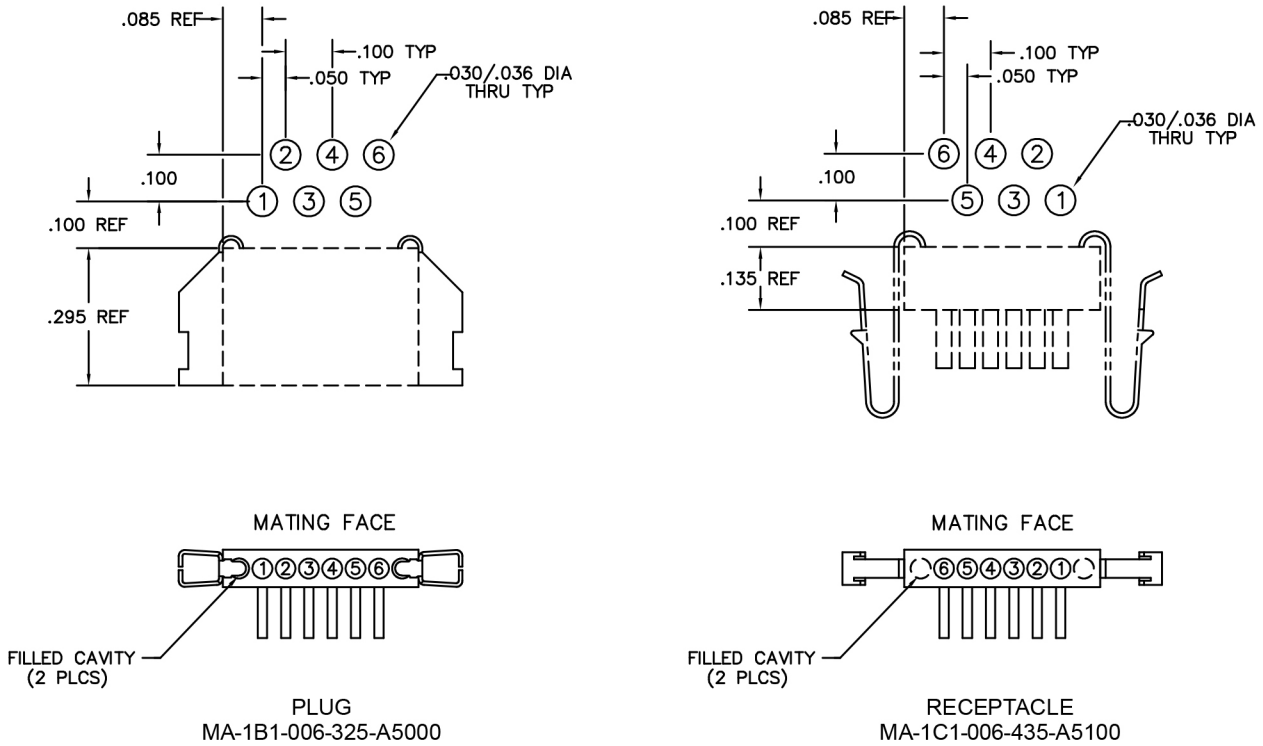

\* = THIS IS THE EXCEPTION AS NOTED IN "MA STRIP GUIDELINES", PAGE M-15, NOTE 3.

**Crimped wire connectors, straight without mounting holes**  
**End mount latches, 2 end cavities**  
**(3 electrical positions, 2 mechanical positions)**



WIRE CONNECT CHART

- 1 — BLK
- 2 — BRN
- 3 — RED



**Board mount connectors, right angle inline (.100") with mounting holes**  
**Side mount latch, centered**

(5 electrical positions, 1 mechanical positions)

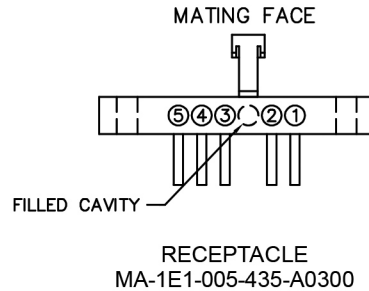
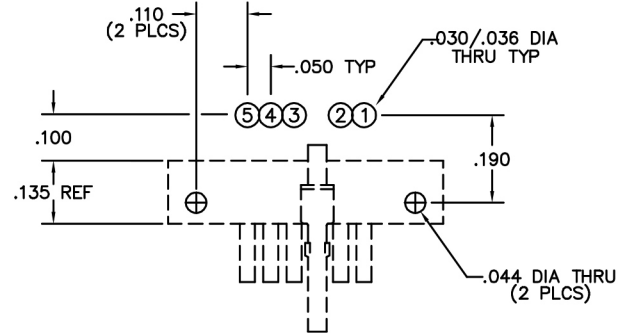
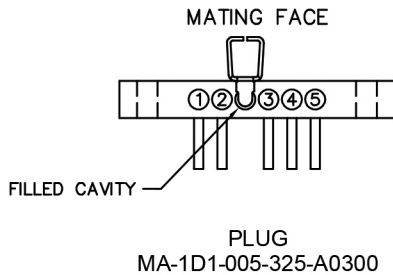
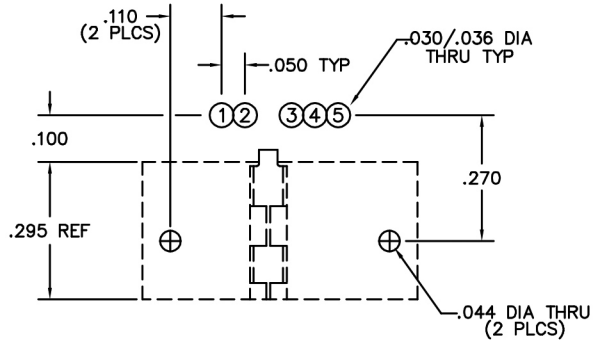

**Crimped wire connectors, straight without mounting holes**  
**Side mount latch, centered**

(5 electrical positions, 1 mechanical positions)

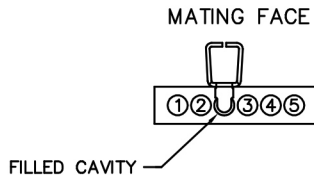

PLUG  
MA-131-005-161-A03WA

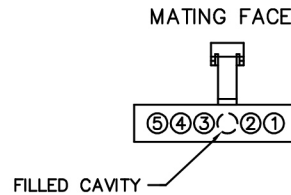

RECEPTACLE  
MA-141-005-261-A03WA

WIRE CONNECT CHART

- 1 — BLK
- 2 — BRN
- 3 — RED
- 4 — ORN
- 5 — YEL

**Board mount connectors, straight offset (.100") without mounting holes**  
**Two guide holes/two end cavities**  
 (4 electrical positions, 2 mechanical positions)

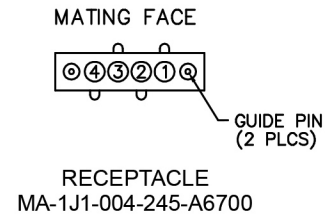
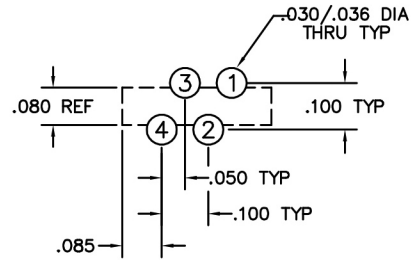
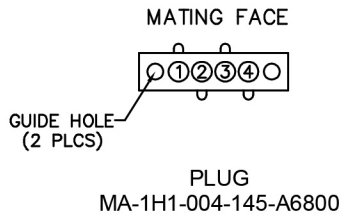
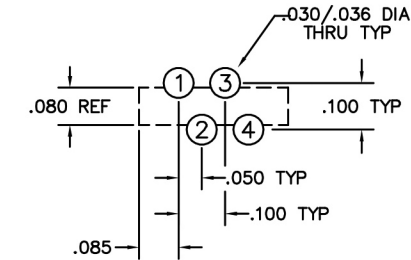

**Board mount connectors, straight without mounting holes**  
**One guide hole/pin, first cavity**  
 (5 electrical positions, 1 mechanical position)

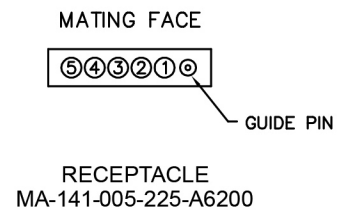
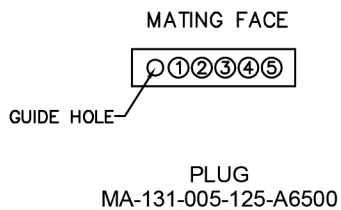

**Crimped wire connectors, straight without mounting holes**  
**Two guide holes/two end cavities**  
 (4 electrical positions, 2 mechanical positions)

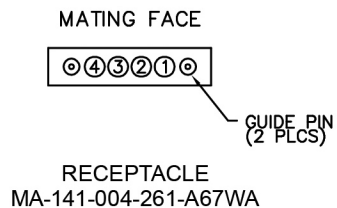
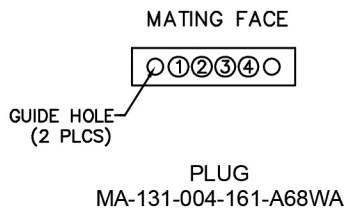

WIRE CONNECT CHART

- 1 — BLK
- 2 — BRN
- 3 — RED
- 4 — ORN



**Board mount connectors, right angle offset (.050") with mounting holes**  
**Guide hole/pin, last cavity**  
 (5 electrical positions, 1 mechanical positions)

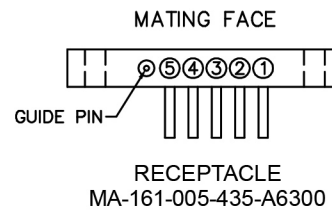
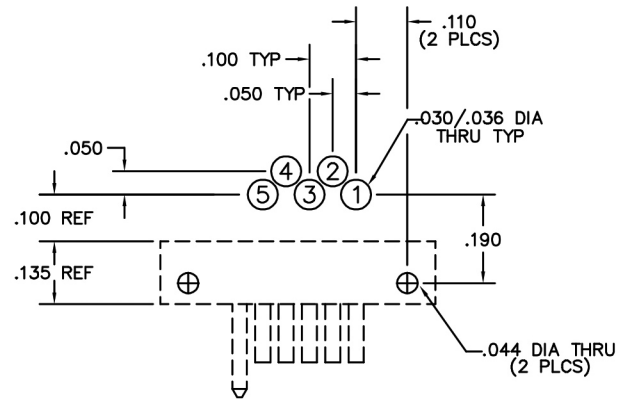
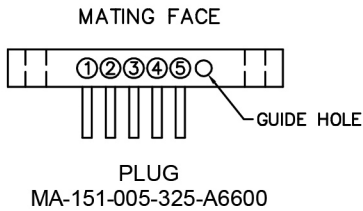
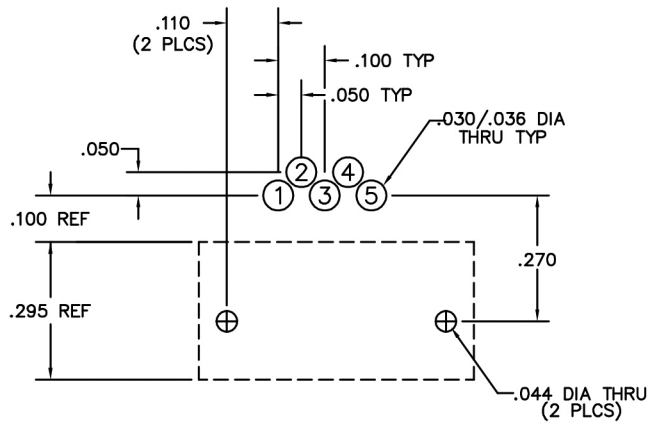

**Crimped wire connectors, straight with mounting holes**  
**Guide hole/pin, last cavity**  
 (5 electrical positions, 1 mechanical positions)

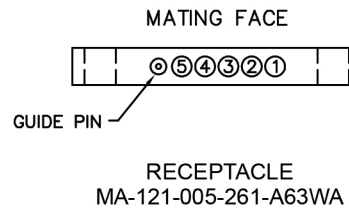
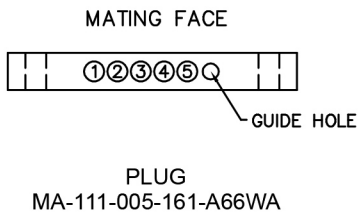

WIRE CONNECT CHART

- 1 — BLK
- 2 — BRN
- 3 — RED
- 4 — ORN
- 5 — YEL



**Board mount connectors, right angle offset (.050") without mounting holes**  
**Guide hole/pin, first cavity\***  
 (5 electrical positions, 1 mechanical positions)

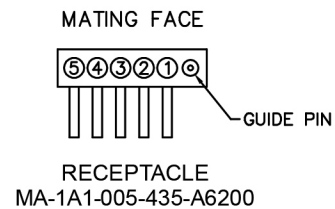
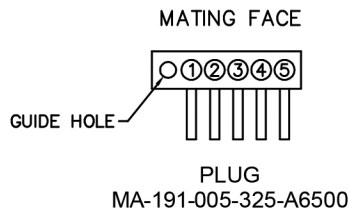
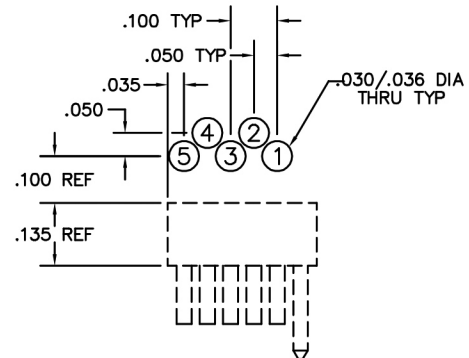
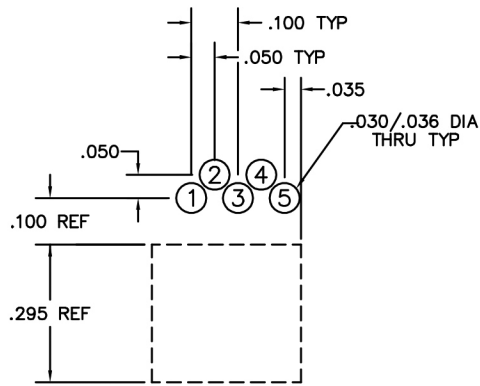

\* = THIS IS THE EXCEPTION AS NOTED IN "MA STRIP GUIDELINES", PAGE M-15, NOTE 3.

**Crimped wire connectors, straight without mounting holes**  
**Guide hole/pin, first cavity**  
 (5 electrical positions, 1 mechanical positions)

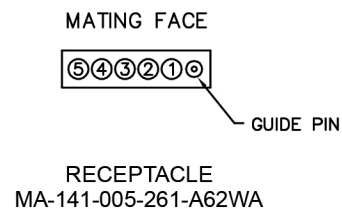
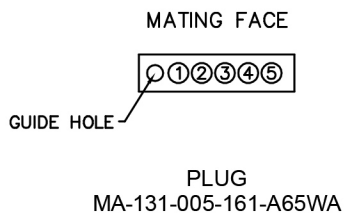

WIRE CONNECT CHART

- 1 — BLK
- 2 — BRN
- 3 — RED
- 4 — ORN
- 5 — YEL



# 2 • ROW Strip Connectors Cable to Cable

.050"

**MA-2**

4 thru 128 Contacts

MA-231-016-161-A64WS

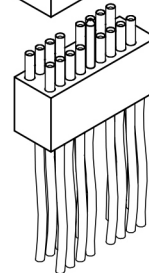
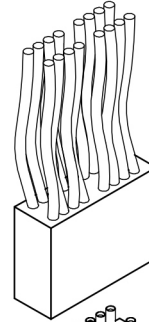

MA-241-016-261-A61WS

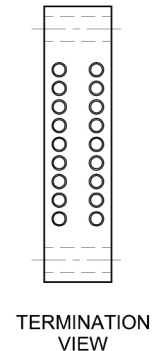
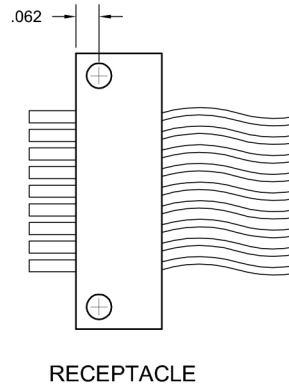
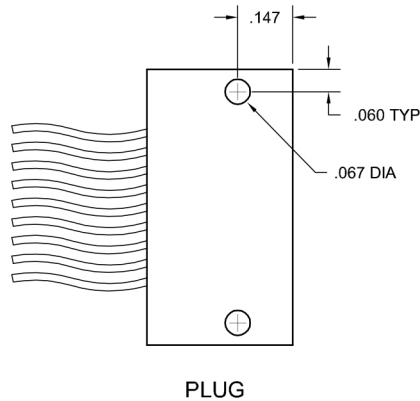
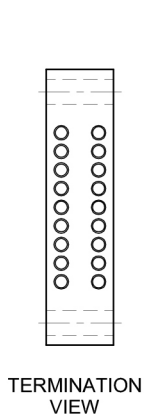
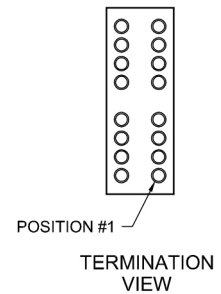
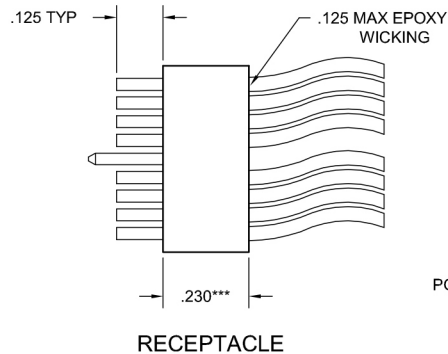
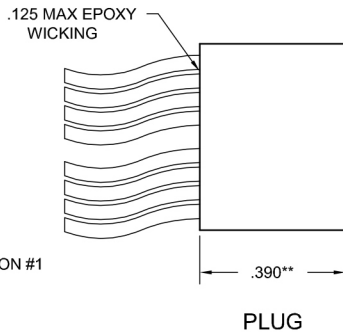
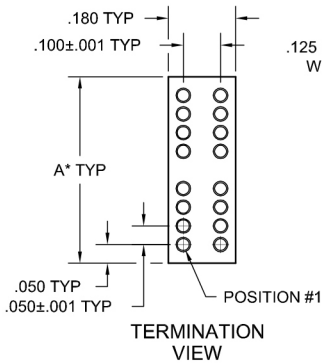

### OPTIONAL MOUNTING HOLES

#### DIMENSIONS

To determine connector length (Dim "A"):

Multiply the number of cavities in one row by .050"	. " /
Add fixed end lengths (constant, .025" x 2)	0.05" /
Add .085" for each mounting hole	. " /
Total Length:	. " /

#### Notes:

- Length over 2" may require support to insure alignment.
- \* = Maximum length is 3.420". Maximum number of contacts must be reduced to accommodate hardware and mounting holes.
- \*\* = For solder cup or board mount applications, .390" becomes .295"
- \*\*\* = For solder cup or board mount applications, .230" becomes .135"

www.airborn.com  
(512) 863-5585

PLUG: MA-231-016-161-A64WS  
 RECEPTACLE: MA-241-016-261-A61WS  
 XX-XXX-XXX-XXX-XXXXX

PLUG		RECEPTACLE	
<b>SERIES</b>			
MA .050" Microminiature Strip Connector		MA .050" Microminiature Strip Connector	
<b>BODY</b>			
2 2-Row		2 2-Row	
BODY STYLE: (Material: Polyphenylene sulfide)		BODY STYLE: (Material: Polyphenylene sulfide)	
11 Plug, straight, with mounting holes		21 Receptacle, straight, with mounting holes	
31 Plug, straight, without mounting holes		41 Receptacle, straight, without mounting holes	
<b>SIZE</b>			
XXX 004 -128		XXX 004 -128	
Note: Maximum number of contacts is reduced when using hardware or mounting holes. See dimension chart on M-23.			
<b>CONTACTS</b>			
TYPE CONTACTS/TERMINATIONS:		TYPE CONTACTS/TERMINATIONS:	
11 Pin, straight, solder cup		21 Socket, straight, solder cup	
14 Pin, straight, .500" pigtails (.018 dia)		24 Socket, straight, .500" pigtails (.018 dia)	
15 Pin, straight, 1.000" pigtails (.018 dia)		25 Socket, straight, 1.000" pigtails (.018 dia)	
16 Pin, straight, crimped wire		26 Socket, straight, crimped wire	
PLATING OPTIONS:		PLATING OPTIONS:	
1 50 μ" Au contacts (crimp wire)		1 50 μ" Au contacts (crimp wire)	
3 50 μ" Au contacts; 10 μ" Au terminations (solder cup, pigtail)		3 50 μ" Au contacts; 10 μ" Au terminations (solder cup, pigtail)	
5 50 μ" Au contacts; Sn/Pb alloy terminations (pigtail) <input checked="" type="checkbox"/>		5 50 μ" Au contacts; Sn/Pb alloy terminations (pigtail) <input checked="" type="checkbox"/>	
7 50 μ" Au contacts; SAC305 terminations (pigtail)		7 50 μ" Au contacts; SAC305 terminations (pigtail)	
<b>HARDWARE</b>			
STYLE OF HARDWARE:		STYLE OF HARDWARE:	
A00 None		A00 None	
ABC Latch box, side mounted (centered)* See page M-27		ALC Latch spring, side mounted (centered)* See page M-27	
A50 Latch boxes (two end cavities). See page M-27**		A51 Latch springs, (two end cavities). See page M-27**	
A52 Latch boxes (two end cavities). See page M-27**		A53 Latch springs, (two end cavities). See page M-27**	
A54 Latch boxes (two end cavities). See page M-27**		A55 Latch springs, (two end cavities). See page M-27**	
A56 Latch boxes (two end cavities). See page M-27**		A57 Latch springs, (two end cavities). See page M-27**	
A64 One guide hole (centered)*		A61 One guide pin (centered)*	
A65 One guide hole (first cavity)		A62 One guide pin (first cavity)	
A66 One guide hole (last cavity)		A63 One guide pin (last cavity)	
A68 Two guide holes (first & last cavity)		A67 Two guide pins (first & last cavity)	
AHX One guide hole (cavity #2 - #9)		APX One guide pin (cavity #2 - #9)	
POLARIZATION / WIRING:		POLARIZATION / WIRING	
00 None		00 None	
XX For wiring codes, see page MA-3 & MA-4		XX For wiring codes, see page MA-3 & MA-4	

\* = To determine location, divide the total number of cavities (in one row) by two and round to the next whole number, if result is a fraction. See page M-28.  
 \*\* = Not available with mounting holes.  
 See MA strip guidelines, page M-28, for location examples & visual clarification.  
 Connector part number must have even number of contacts.  
 Consult factory for non-standard requirements.

= Option not RoHS compliant



# 2 • ROW Strip Connectors Board to Cable

.050"

**MA-2**

4 thru 128 Contacts

MA-2F1-010-325-A5200

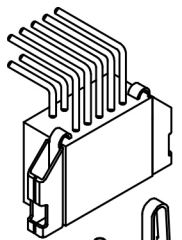

MA-241-010-261-A53WA

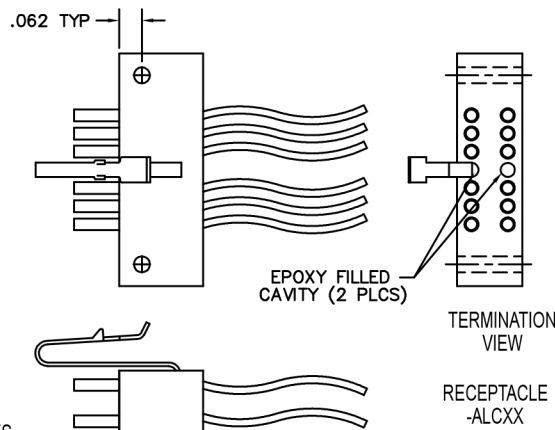
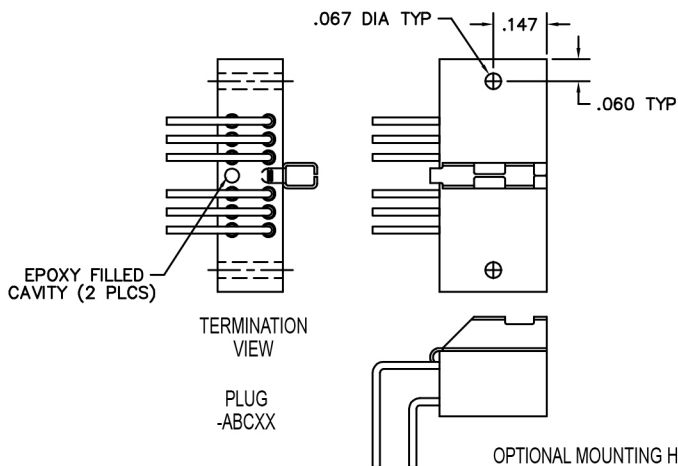
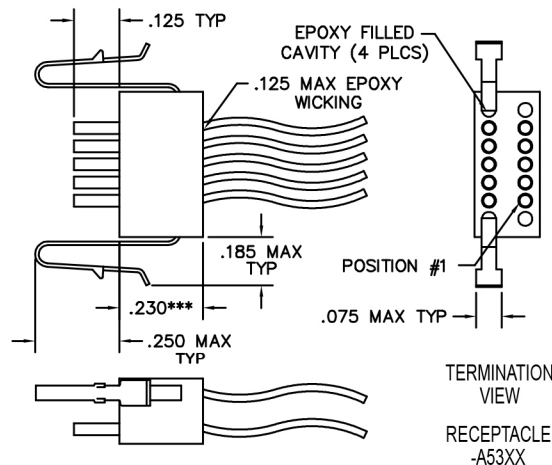
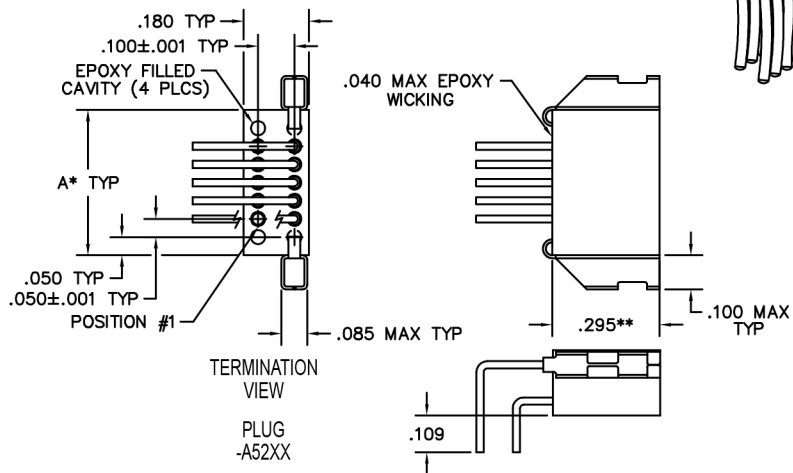
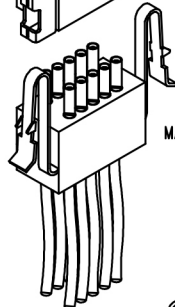

**DIMENSIONS**

To determine connector length (Dim "A"):  
 Multiply the number of cavities in one row by .050"  
 Add fixed end lengths (constant .025" x 2)  
 Add .085" for each mounting hole

	"
.....	0.05"
.....	"
.....	"
.....	"

Total Length: .....

Notes:  
 Length over 2" may require support to insure alignment  
 \* = Maximum length is 3.420". Maximum number of contacts must be reduced to accommodate hardware and mounting holes.  
 \*\* = For cable applications, .295" becomes .390"  
 \*\*\* = For solder cup or board mount applications, .230" becomes .135"



**LEAD CONFIGURATION OPTIONS**

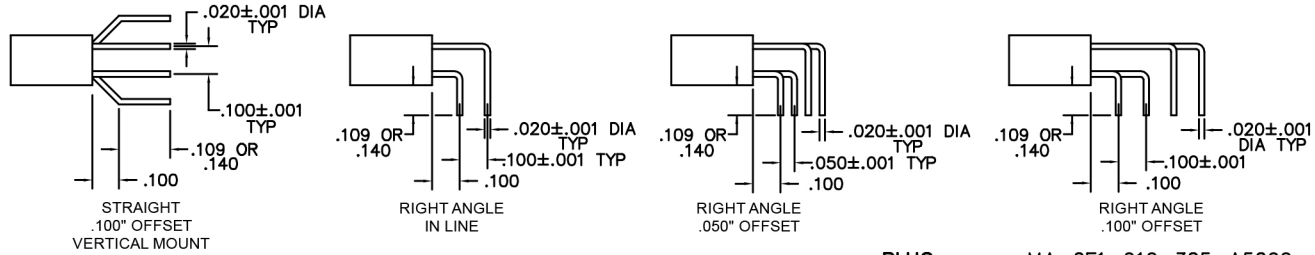

**PLUG:** MA-2F1-010-325-A5200  
**RECEPTACLE:** MA-241-010-261-A53WA  
 XX-XXX-XXX-XXX-XXXXX

PLUG		RECEPTACLE	
<b>SERIES</b>			
MA .050" Microminiature Strip Connector		MA .050" Microminiature Strip Connector	
<b>BODY</b>			
2 2-Row	BODY STYLE: (Material: Polyphenylene sulfide) 11 Plug, straight, with mounting holes 31 Plug, straight, without mounting holes 51 Plug, right angle, .050" offset, with mounting holes 71 Plug, right angle, .100" offset, with mounting holes 91 Plug, right angle, .050" offset, without mounting holes B1 Plug, right angle, .100" offset, without mounting holes D1 Plug, right angle, in line, with mounting holes F1 Plug, right angle, in line, without mounting holes H1 Plug, straight, .100" offset, without mounting holes	2 2-Row	BODY STYLE: (Material: Polyphenylene sulfide) 21 Receptacle, straight, with mounting holes 41 Receptacle, straight, without mounting holes 61 Receptacle, right angle, .050" offset, with mounting holes 81 Receptacle, right angle, .100" offset, with mounting holes A1 Receptacle, right angle, .050" offset, without mounting holes C1 Receptacle, right angle, .100" offset, without mounting holes E1 Receptacle, right angle, in line, with mounting holes G1 Receptacle, right angle, in line, without mounting holes J1 Receptacle, straight, .100" offset, without mounting holes
<b>SIZE</b>			
XXX 004- 128		XXX 004-128	
Note: Maximum number of contacts is reduced when using hardware or mounting holes. See dimension chart on M-25.			
<b>CONTACTS</b>			
<b>TYPE CONTACTS/TERMINATIONS:</b> 11 Pin, straight, solder cup 12 Pin, straight, PCB leads, .109" 13 Pin, straight, PCB leads, .140" 14 Pin, straight, .500" pigtailed (.018 dia) 15 Pin, straight, 1.000" pigtailed (.018 dia) 16 Pin, straight, crimped wire 32 Pin, right angle, PCB leads, .109" 33 Pin, right angle, PCB leads, .140"  <b>PLATING OPTIONS:</b> 1 50 μ" Au contacts (crimp wire) 3 50 μ" Au contacts: 10 μ" Au terminations (solder cup, pigtail, PCB leads) 5 50 μ" Au contacts; Sn/Pb alloy terminations (pigtail, PCB leads) ☒ 7 50 μ" Au contacts; SAC305 terminations (pigtail, PCB leads)		<b>TYPE CONTACTS/TERMINATIONS:</b> 21 Socket, straight, solder cup 22 Socket, straight, PCB leads, .109" 23 Socket, straight, PCB leads, .140" 24 Socket, straight, .500" pigtailed (.018 dia) 25 Socket, straight, 1.000" pigtailed (.018 dia) 26 Socket, straight, crimped wire 43 Socket, right angle, PCB leads, .109" 44 Socket, right angle, PCB leads, .140"  <b>PLATING OPTIONS:</b> 1 50 μ" Au contacts (crimp wire) 3 50 μ" Au contacts: 10 μ" Au terminations (solder cup, pigtail, PCB leads) 5 50 μ" Au contacts; Sn/Pb alloy terminations (pigtail, PCB leads) ☒ 7 50 μ" Au contacts; SAC305 terminations (pigtail, PCB leads)	
<b>HARDWARE</b>			
<b>STYLE OF HARDWARE:</b> A00 None ABC Latch box, side mounted (centered)* See page M-27 A50 Latch boxes (two end cavities). See page M-27** A52 Latch boxes (two end cavities). See page M-27** A54 Latch boxes (two end cavities). See page M-27** A56 Latch boxes (two end cavities). See page M-27** A64 One guide hole (centered)* A65 One guide hole (first cavity) A66 One guide hole (last cavity) A68 Two guide holes (first & last cavity) AHX One guide hole (cavity #2 - #9)		<b>STYLE OF HARDWARE:</b> A00 None ALC Latch spring, side mounted (centered)* See page M-27 A51 Latch springs, (two end cavities). See page M-27** A53 Latch springs, (two end cavities). See page M-27** A55 Latch springs, (two end cavities). See page M-27** A57 Latch springs, (two end cavities). See page M-27** A61 One guide pin (centered)* A62 One guide pin (first cavity) A63 One guide pin (last cavity) A67 Two guide pins (first & last cavity) APX One guide pin (cavity #2 - #9)	
<b>POLARIZATION / WIRING:</b> 00 None XX For wiring codes, see page MA-3 & MA-4		<b>POLARIZATION / WIRING:</b> 00 None XX For wiring codes, see page MA-3 & MA-4	

\* = To determine location, divide the total number of cavities (in one row) by two and round to the next whole number, if result is a fraction. See page M-28.  
 \*\* = Not available with mounting holes.  
 See MA strip guidelines, page M-28, for location examples & visual clarification.  
 Connector part number must have even number of contacts.  
 Consult factory for non-standard requirements.  
 ☒ = Option not RoHS compliant



# 2 • ROW Strip Connectors with Latches

.050"

**MA-2**

4 thru 128 Contacts

PLUG  
LATCH BOX

EXAMPLE: MA-231-012-161-A50WN

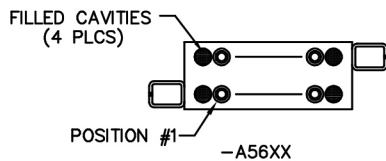
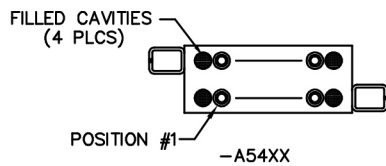
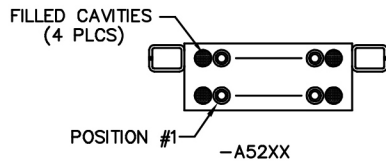
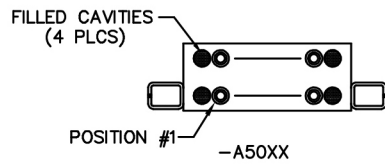

RECEPTACLE  
LATCH SPRING

EXAMPLE: MA-241-012-261-A51WN

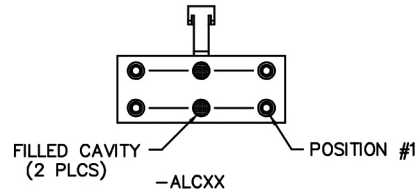
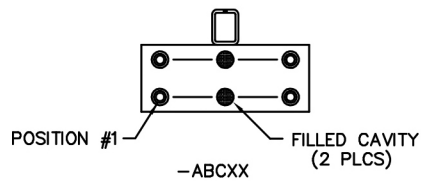
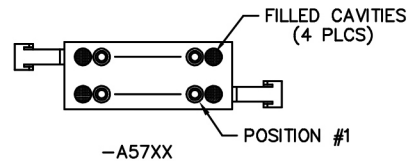
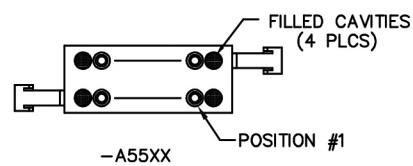
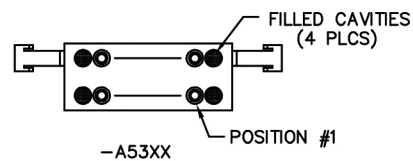
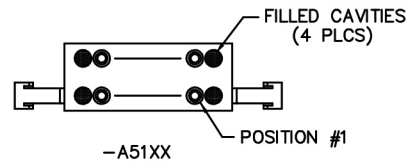

NOTE: ALL DRAWINGS VIEWED FROM MATING FACE

## MA Strip Guidelines

### For "A" designator in hardware portion of part number

1. Any cavity that has a contact is considered an electrical position (including dummy contact).
2. All hardware locations, holes and/or epoxy filled cavities are considered mechanical positions.
3. The cavity adjacent to a mechanical hole, in opposite row, will be an epoxy filled cavity (two row only).
4. Side mount latch will always be in row two of connector (two row only).
5. Connector must always have an even number of contacts for standard part number (two row only). Consult factory for non-standard requirements.
6. Omit holes on board layout for mechanical positions and renumber board layout accordingly, except connectors with mechanical position(s) in end cavity(ies).  
See board layout examples, pages M-29 thru M-34.
7. These guidelines apply for all hardware options, including guide holes (mechanical locations).
8. Do not skip wire colors on stranded wire assemblies.
9. Spacers underneath the connector are recommended when R/A PCB mount connectors with mounting holes are used and the PCB had irregularities greater than .004" underneath the connector.

#### To determine centered hardware location number:

1. Divide the total number of cavities in one row by two (including hardware cavity).
2. Round to the next whole number if result is a fraction.
3. Guide hardware will be located in Row 1 and Latch hardware will be in Row 2.

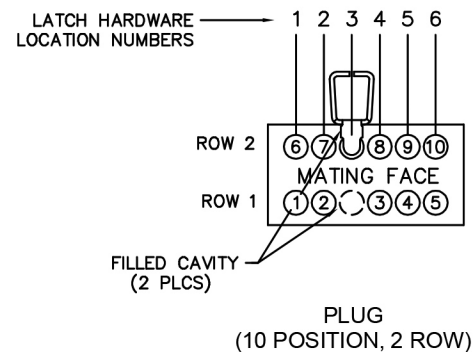
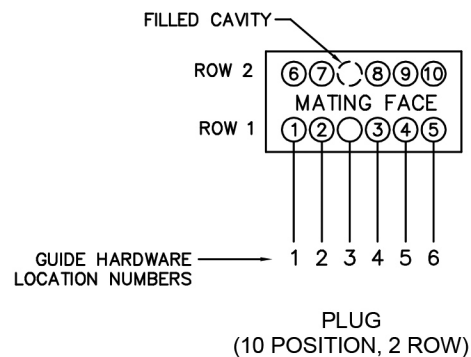

The example above shows 12 cavities with 10 live contacts.  
(10 electrical positions & 2 mechanical positions)

To determine the hardware location number:  
 $6 \text{ cavities (in one row)} \div 2 = 3$   
 Hardware would be placed in location #3.



**Board mount connectors, right angle offset (.100") with mounting holes  
(12 electrical positions)**

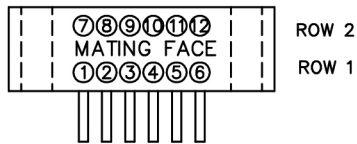
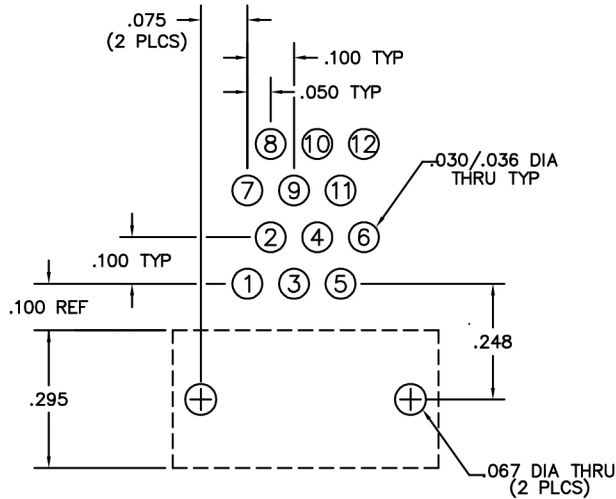

PLUG  
MA-271-012-325-A0000

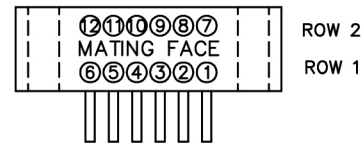
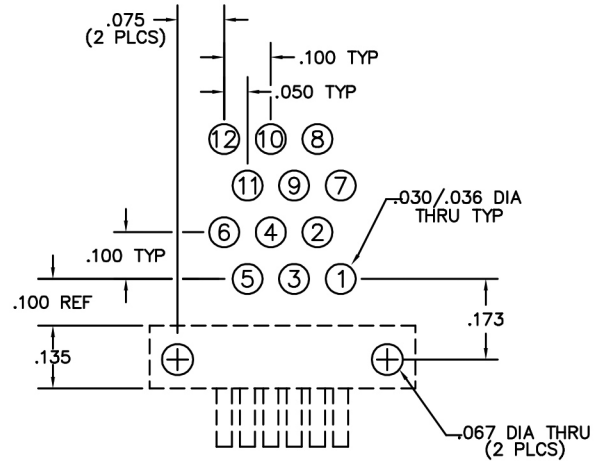

RECEPTACLE  
MA-281-012-435-A0000

**Crimped wire connectors, straight without mounting holes  
(12 electrical positions)**



PLUG  
MA-231-012-161-A00WA



RECEPTACLE  
MA-241-012-261-A00WA

WIRE CONNECT CHART

1 — BLK	7 — BLU
2 — BRN	8 — VIO
3 — RED	9 — GRY
4 — ORN	10 — WHT
5 — YEL	11 — WHT/BLK
6 — GRN	12 — WHT/BRN

**Board mount connectors, right angle offset (.100") with mounting holes.  
Side mount latch, centered.**

Note: Side mount latch will always be in row #2 of connector. Not recommended on row #1 for board mount applications.

(10 electrical positions, 2 mechanical positions)

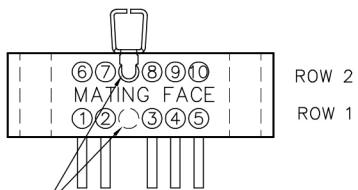
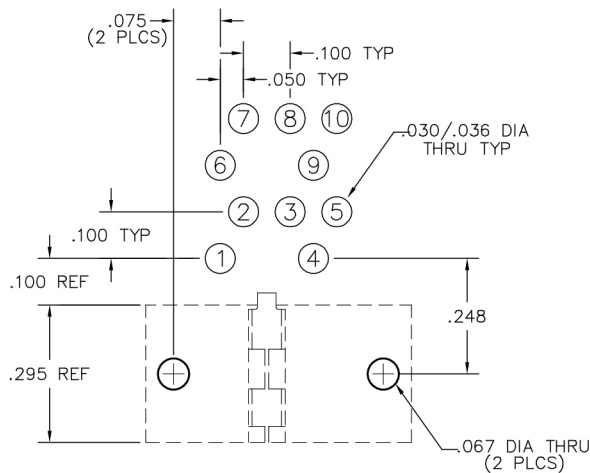

PLUG  
MA-271-010-325-ABC00

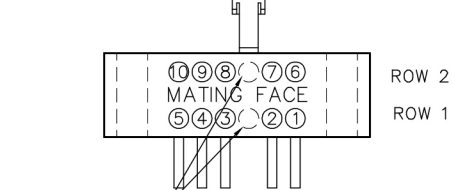
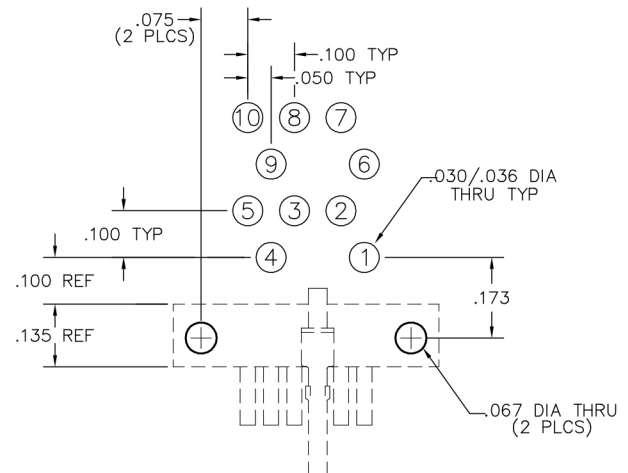

RECEPTACLE  
MA-281-010-435-ALC00

**Crimped wire connectors, straight with mounting holes.  
Side mount latch, centered.**

Note: Side mount latch will always be in row #2 of connector.

(10 electrical positions, 2 mechanical positions)

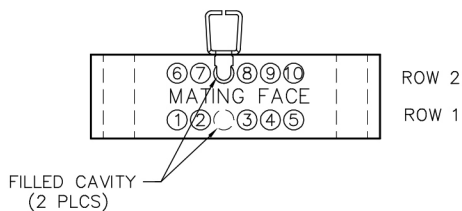

PLUG  
MA-211-010-161-ABCWA

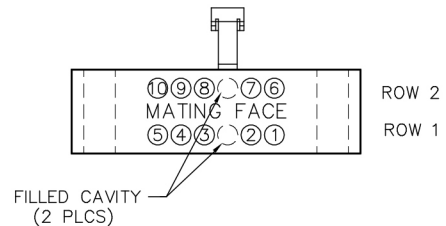

RECEPTACLE  
MA-221-010-261-ALCWA

WIRE CONNECT CHART

1 — BLK	6 — GRN
2 — BRN	7 — BLU
3 — RED	8 — VIO
4 — ORN	9 — GRY
5 — YEL	10 — WHT



**Board mount connectors, right angle offset (.100") without mounting holes**  
**End mount latches, 2 end cavities\***  
 (12 electrical positions, 4 mechanical positions)

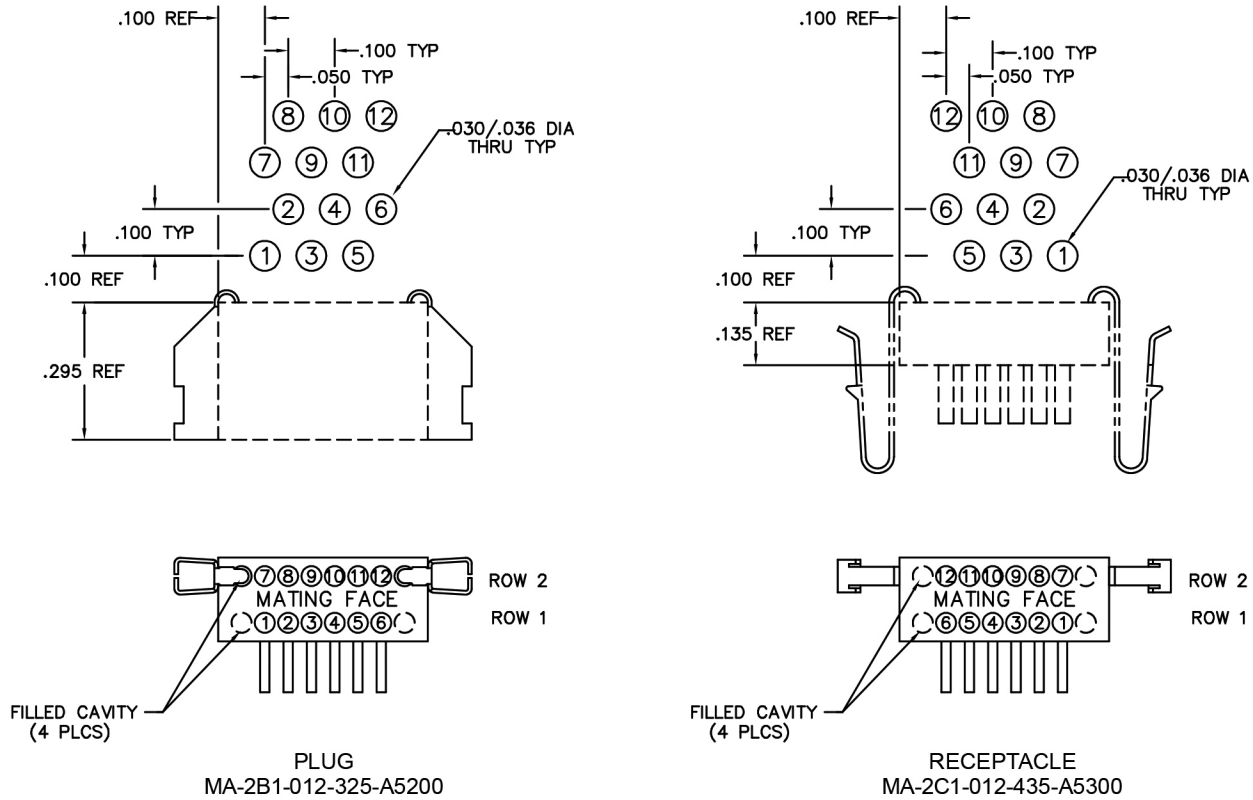

\* = THIS IS THE EXCEPTION AS NOTED IN "MA STRIP GUIDELINES", PAGE M-28, NOTE 6.

**Crimped wire connectors, straight without mounting holes**  
**End mount latches, 2 end cavities**  
 (6 electrical positions, 4 mechanical positions)

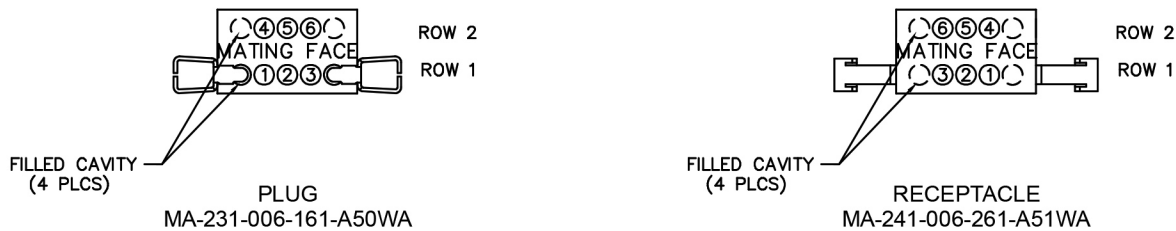

WIRE CONNECT CHART

- 1 — BLK
- 2 — BRN
- 3 — RED
- 4 — ORN
- 5 — YEL
- 6 — GRN

## Board mount connectors, right angle inline (.100") with mounting holes Side mount latch, centered

Note: Side mount latch will always be in row #2 of connector. Not recommended on row #1 for board mount applications.

(10 electrical positions, 2 mechanical positions)

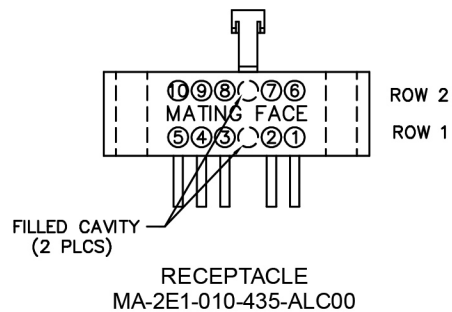
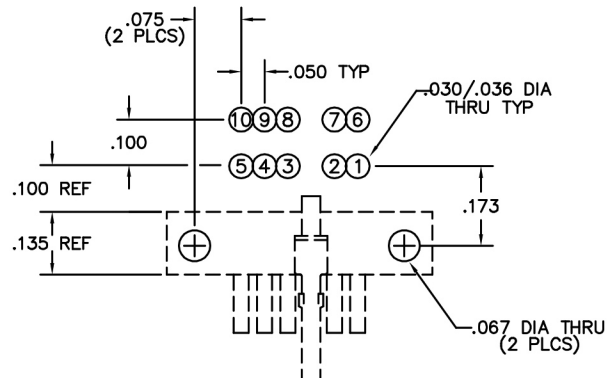
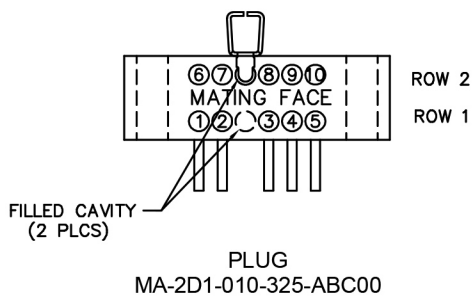
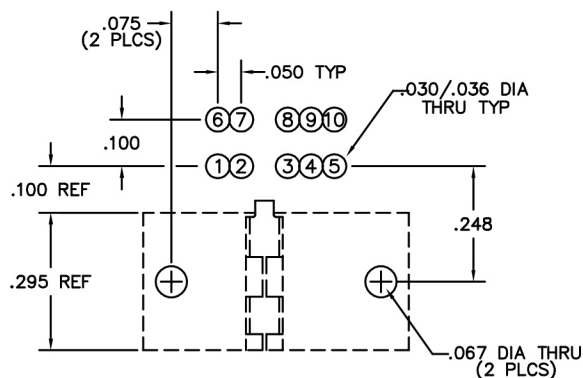

## Crimped wire connectors, straight without mounting holes Side mount latch, centered

(10 electrical positions, 2 mechanical positions)

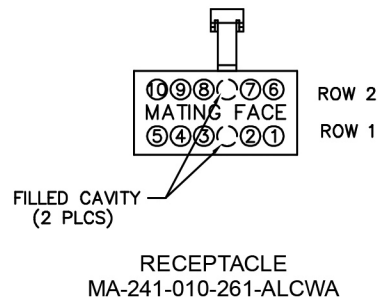
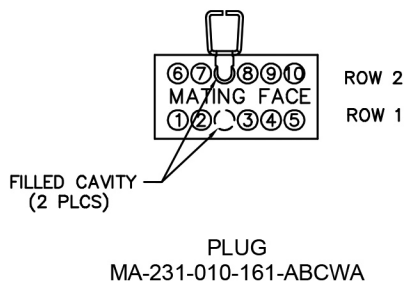

### WIRE CONNECT CHART

1 — BLK	6 — GRN
2 — BRN	7 — BLU
3 — RED	8 — VIO
4 — ORN	9 — GRY
5 — YEL	10 — WHT



**Board mount connectors, straight offset (.100") without mounting holes**  
**Two guide holes/pins, first & last cavities**  
**(8 electrical positions, 4 mechanical positions)**

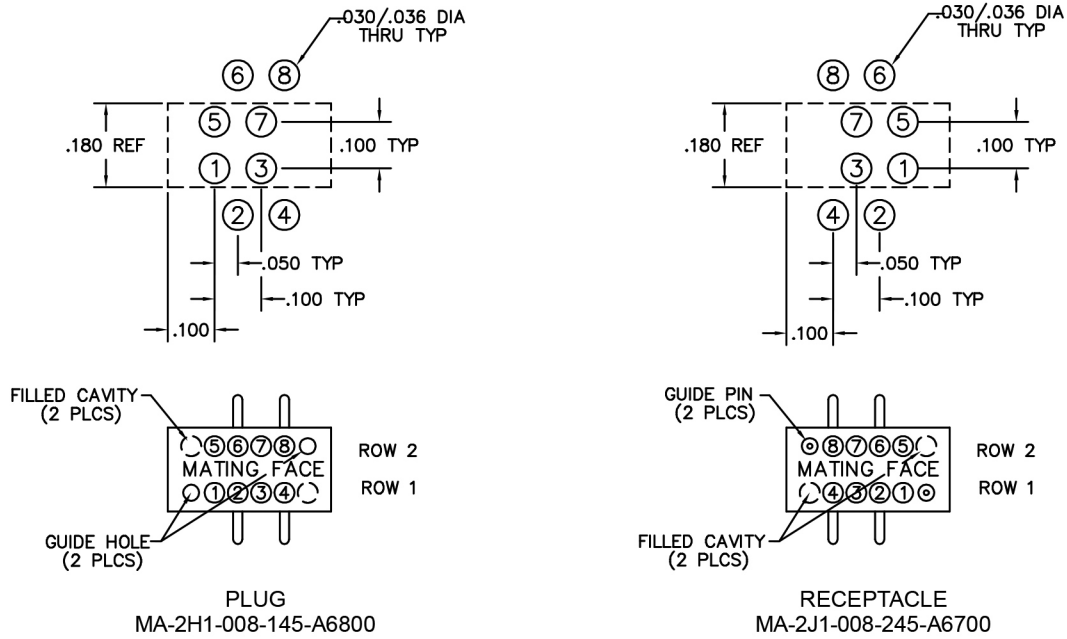

**Crimped wire connectors, straight without mounting holes**  
**Two guide holes/pins, first & last cavities**  
**(8 electrical positions, 4 mechanical positions)**

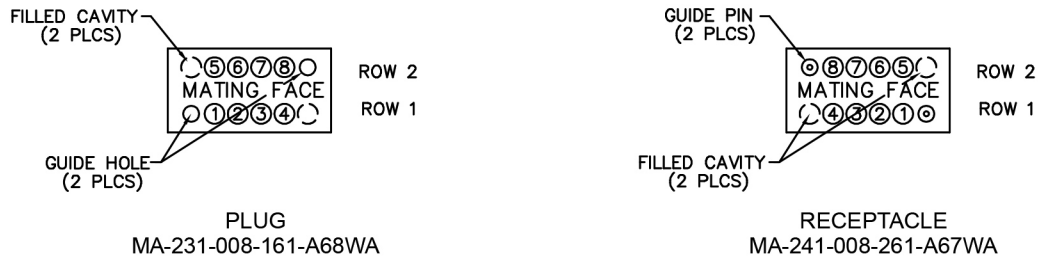

WIRE CONNECT CHART

1 — BLK	5 — YEL
2 — BRN	6 — GRN
3 — RED	7 — BLU
4 — ORN	8 — VIO

**Board mount connectors, right angle offset (.050") with mounting holes**  
**Guide hole/pin, last cavity**  
 (10 electrical positions, 2 mechanical positions)

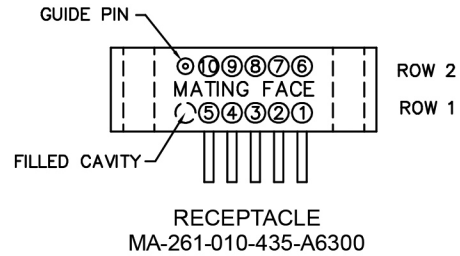
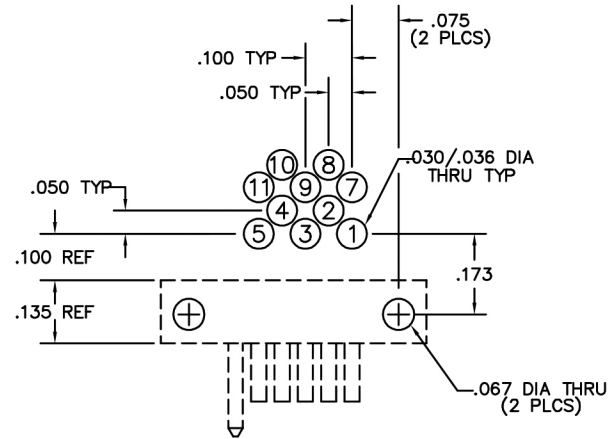
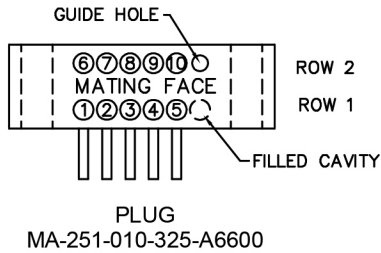
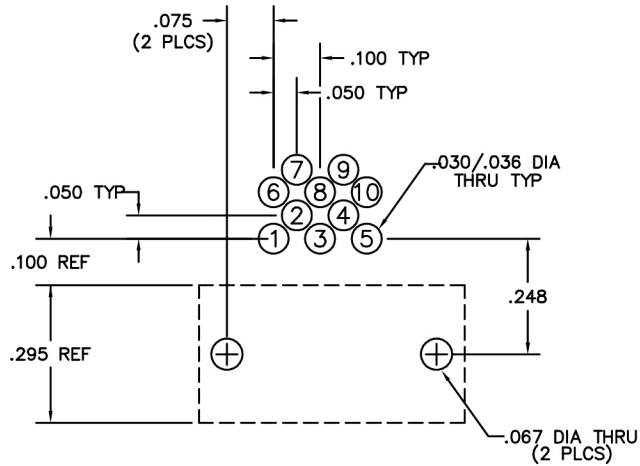

**Crimped wire connectors, straight with mounting holes**  
**Guide hole/pin, last cavity**  
 (10 electrical positions, 2 mechanical positions)

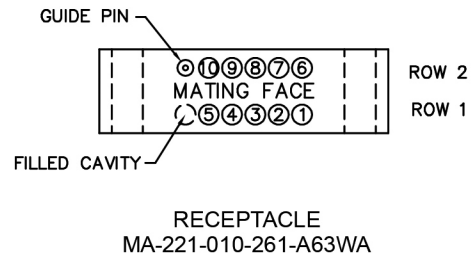
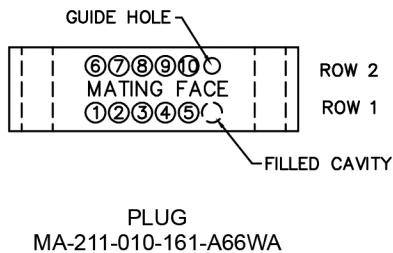

**WIRE CONNECT CHART**

1 — BLK	6 — GRN
2 — BRN	7 — BLU
3 — RED	8 — VIO
4 — ORN	9 — GRY
5 — YEL	10 — WHT



# Cable to Cable

**.050"**

**9 thru 100 Contacts**

**Rugged Metal**

**MM**

**Rugged Plastic**

**MN**

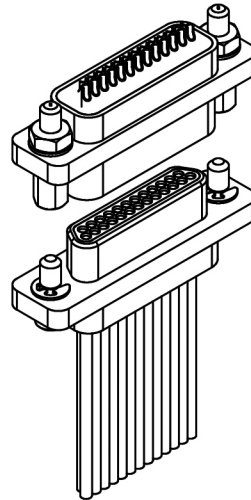

MM-223-025-2A3-2200  
(METAL)

MN-221-025-2A3-2200  
(PLASTIC)

MM-212-025-161-41WA  
(METAL)

MN-211-025-161-41WA  
(PLASTIC)

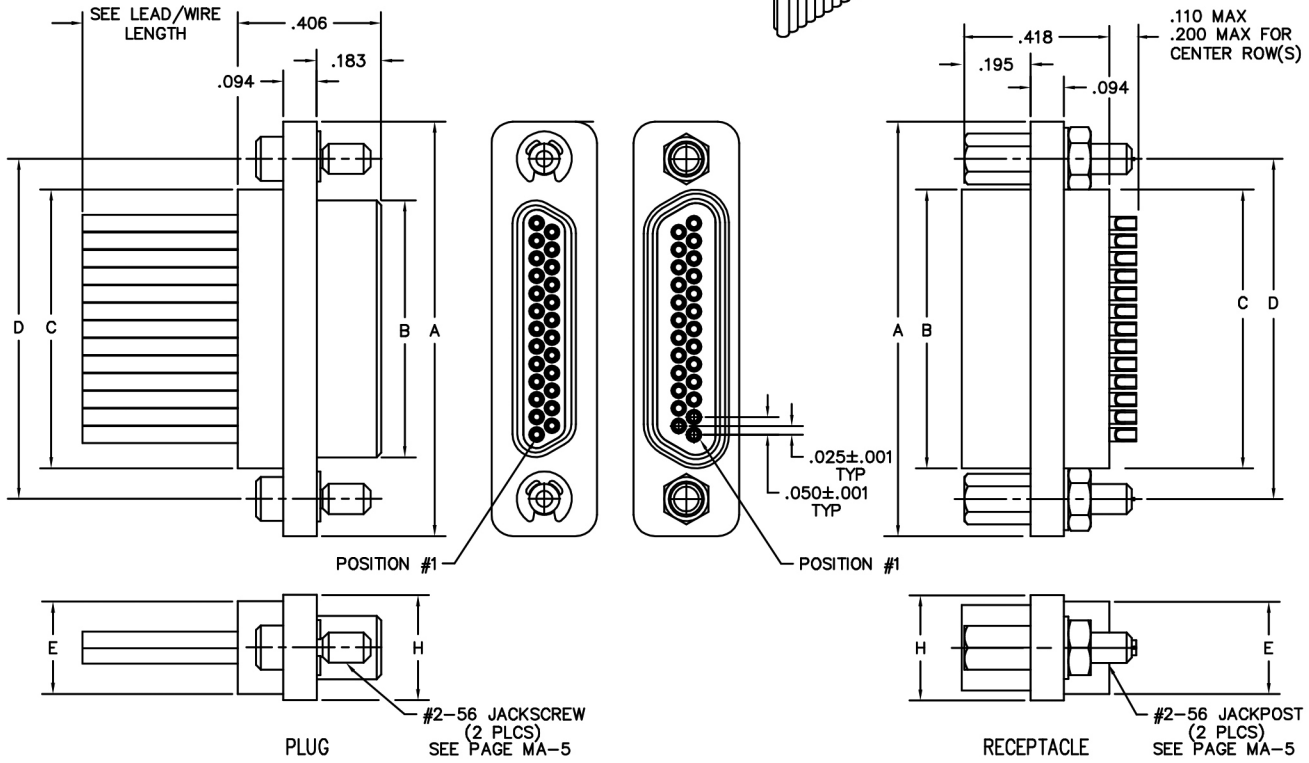

SIZE	CONTACT ROWS	DIMENSIONS						H	HARDWARE
		A	B		C	D	E		
			PLUG MAX	RCPT MAX			POTTING WELL MAX		
9	2	.775	.334	.400	.390	.565	.270	.298	#2-56 UNC THD (.092 DIA THRU)
15		.925	.484	.550	.540	.715			
21		1.075	.634	.700	.690	.865			
25		1.175	.734	.800	.790	.965			
31		1.325	.884	.950	.940	1.115			
37		1.475	1.034	1.100	1.090	1.265			
51**	3	1.825	1.384	1.450	1.440	1.615	.310	.341	
51		1.425	.984	1.050	1.040	1.215			
69		1.725	1.284	1.350	1.340	1.515			
100		4	2.160	1.384	1.508	1.432			

\* = 69 POSITION CONNECTORS ARE AVAILABLE IN METAL ONLY.  
 \*\* = 2 ROW, 51 POSITION CONNECTORS ARE AVAILABLE IN METAL ONLY,  
 (NON MIL-SPEC INTERFACE).



**PLUG:** MM-212-031-161-41WA  
**RECEPTACLE:** MM-222-031-2G3-4500  
**PLUG:** MN-211-031-161-41WA  
**RECEPTACLE:** MN-221-031-2G3-4500  
 XX-XXX-XXX-XXX-XXXX-XXX

PLUG		RECEPTACLE	
<b>SERIES</b>			
MM .050" Rugged Metal I/O Connector MN .050" Rugged Plastic I/O Connector (MM & MN mate with MK, ML, MM, MN receptacles)		MM .050" Rugged Metal I/O Connector MN .050" Rugged Plastic I/O Connector (MM & MN mate with MK, ML, MM, MN plugs)	
<b>BODY</b>			
2 2-Row (Sizes 9 thru 51****)	3 3-Row (Size 51 & 69***)	2 2-Row (Sizes 9 thru 51****)	3 3-Row (Size 51 & 69***)
4 4-Row (Size 100)		4 4-Row (Size 100)	
<b>BODY STYLE:</b> 1 Plug, straight, with ears		<b>BODY STYLE:</b> 2 Receptacle, straight, with ears	
<b>BODY MATERIAL:</b> 1 Polyphenylene Sulfide (MN only) 2 Polyphenylene Sulfide with electroless nickel shell 3 Polyphenylene Sulfide with electrodeposited cadmium shell <input checked="" type="checkbox"/> 4 Polyphenylene Sulfide with hard anodized black shell 5 Polyphenylene Sulfide with stainless steel shell A Pure Electro-Deposited Aluminum K Zinc Nickel Plating T Nickel Polymer Plating		<b>BODY MATERIAL:</b> 1 Polyphenylene Sulfide (MN only) 2 Polyphenylene Sulfide with electroless nickel shell 3 Polyphenylene Sulfide with electrodeposited cadmium shell <input checked="" type="checkbox"/> 4 Polyphenylene Sulfide with hard anodized black shell 5 Polyphenylene Sulfide with stainless steel shell A Pure Electro-Deposited Aluminum K Zinc Nickel Plating T Nickel Polymer Plating	
<b>SIZE</b>			
XXX 009, 015, 021, 025, 031, 037, 051****, 069***, 100		XXX 009, 015, 021, 025, 031, 037, 051****, 069***, 100	
<b>CONTACTS</b>			
<b>TYPE CONTACTS/TERMINATIONS:</b> 11 Pin, straight, 26 awg solder cup 1A Pin, straight, 24 awg solder cup 1D Pin, straight, .109" Lead Length (.018 dia) 1E Pin, straight, .125" Lead Length (.018 dia) 1F Pin, straight, .140" Lead Length (.018 dia) 1G Pin, straight, .156" Lead Length (.018 dia) 1H Pin, straight, .172" Lead Length (.018 dia) 1J Pin, straight, .187" Lead Length (.018 dia) 13 Pin, straight, .250" Lead Length (.018 dia) 1K Pin, straight, .375" Lead Length (.018 dia) 14 Pin, straight, .500" Lead Length (.018 dia) 15 Pin, straight, 1.000" Lead Length (.018 dia) 16 Pin, straight, crimped wire		<b>TYPE CONTACTS/TERMINATIONS:</b> 21 Socket, straight, 26 awg solder cup 2A Socket, straight, 24 awg solder cup 2D Socket, straight, .109" Lead Length (.018 dia) 2E Socket, straight, .125" Lead Length (.018 dia) 2F Socket, straight, .140" Lead Length (.018 dia) 2G Socket, straight, .156" Lead Length (.018 dia) 2H Socket, straight, .172" Lead Length (.018 dia) 2J Socket, straight, .187" Lead Length (.018 dia) 23 Socket, straight, .250" Lead Length (.018 dia) 2K Socket, straight, .375" Lead Length (.018 dia) 2L Socket, straight, .500" Lead Length (.018 dia) 2M Socket, straight, 1.000" Lead Length (.018 dia) 26 Socket, straight, crimped wire	
<b>PLATING OPTIONS:</b> 1 50 μ" Au contacts (crimp wire) 3 50 μ" Au contacts (solder cup, pigtail) 5 50 μ" Au contacts; Sn/Pb alloy terminations <input checked="" type="checkbox"/> 7 50 μ" Au contacts; SAC305 terminations		<b>PLATING OPTIONS:</b> 1 50 μ" Au contacts (crimp wire) 3 50 μ" Au contacts (solder cup, pigtail) 5 50 μ" Au contacts; Sn/Pb alloy terminations <input checked="" type="checkbox"/> 7 50 μ" Au contacts; SAC305 terminations	
<b>HARDWARE</b>			
<b>STYLE OF HARDWARE:</b> 00 None 22 Two fixed jacknut assemblies (62*) 41 Two turning jackscrews, allen head, retaining ring (81*) 42 Two long turning jackscrews, allen head, retaining ring (82*) 43 Two turning jackscrews, slot head, retaining ring (83*) 44 Two long turning jackscrews, slot head, retaining ring (84*) 45 Two turning jackscrews, allen head, captivated** (85*) 99 Keying hardware, see options below. (Body material 2, 3 and 4 only)		<b>STYLE OF HARDWARE:</b> 00 None 22 Two fixed jacknut assemblies (62*) 41 Two turning jackscrews, allen head, retaining ring (81*) 42 Two long turning jackscrews, allen head, retaining ring (82*) 43 Two turning jackscrews, slot head, retaining ring (83*) 44 Two long turning jackscrews, slot head, retaining ring (84*) 45 Two turning jackscrews, allen head, captivated** (85*) 99 Keying hardware, see options below. (Body material 2, 3 and 4 only)	
<b>POLARIZATION / WIRING</b> 00 None XX For wiring codes, see page MA-3 & MA-4		<b>POLARIZATION / WIRING</b> 00 None XX For wiring codes, see page MA-3 & MA-4	
<b>OPTIONS</b>			
KSXX Two turning jackscrews. See page MA-6 for keying options (KJ*) KPXX Two fixed jacknuts. See page MA-6 for keying options (KN*)		KSXX Two turning jackscrews and interfacial sealing gasket. See page MA-6 for keying options (KJ*) KPXX Two fixed jacknuts and interfacial sealing gasket. See page MA-6 for keying options (KN*) 900 Interfacial sealing gasket	

\* = Use numbers or letters in parenthesis when ordering size 100.  
 \*\* = Captive hardware is factory installed and non-removable.  
 \*\*\* = 69 position connectors are available in metal only.  
 \*\*\*\* = 2 row, 51 position connectors are available in metal only (non Mil-Spec interface).  
 = Option not RoHS compliant



# Cable to Cable Grounding Fingers

.050"  
9 thru 100 Contacts  
Rugged Metal

**MM**

MM-212-031-161-22WQ  
(METAL)

MM-2D2-031-261-41WA  
(METAL)

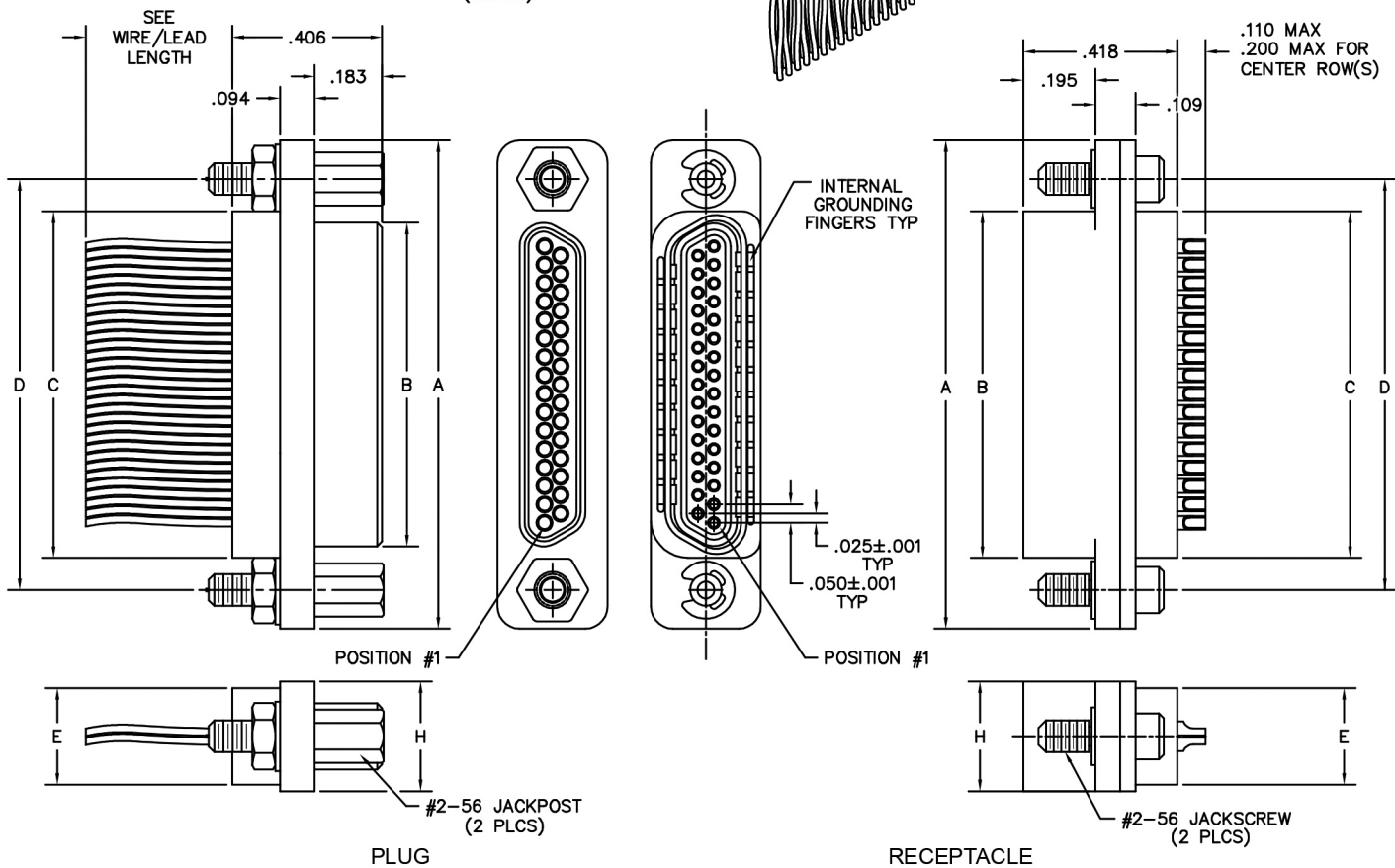
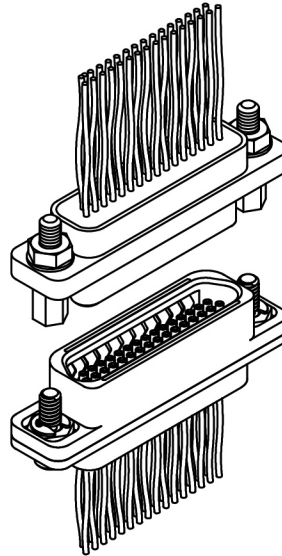

SIZE	CONTACT ROWS	DIMENSIONS							
		A	B		C	D	E POTTING WELL MAX	H	HARDWARE
			PLUG MAX	RCPT MAX					
9	2	.775	.334	.400	.390	.565	.270	.298	#2-56 UNC THD (.092 DIA THRU)
15		.925	.484	.550	.540	.715			
21		1.075	.634	.700	.690	.865			
25		1.175	.734	.800	.790	.965			
31		1.325	.884	.950	.940	1.115			
37		1.475	1.034	1.100	1.090	1.265			
51	3	1.425	.984	1.050	1.040	1.215	.310	.341	#4-40 UNC THD (.147 DIA THRU)
69		1.725	1.284	1.350	1.340	1.515			
100	4	2.160	1.384	1.508	1.432	1.800	.360	.384	#4-40 UNC THD (.147 DIA THRU)



PLUG: MM-212-031-161-22WQ  
 RECEPTACLE: MM-2D2-031-261-41WA  
 XX-XXX-XXX-XXX-XXXX-XXX

PLUG		RECEPTACLE	
<b>SERIES</b>			
MM .050" Rugged Metal I/O Connector (MM mates with MK, ML, MM, MN receptacles)		MM .050" Rugged Metal I/O Connector (MM mates with MK, ML, MM, MN plugs)	
<b>BODY</b>			
2 2-Row (Sizes 9 thru 37)	3 3-Row (Size 51 & 69)	4 4-Row (Size 100)	
BODY STYLE: 1 Plug, straight, with ears		D Receptacle, straight, with grounding fingers	
BODY MATERIAL: 2 Polyphenylene Sulfide with electroless nickel shell 3 Polyphenylene Sulfide with electrodeposited cadmium shell <input checked="" type="checkbox"/> 6 Polyphenylene Sulfide with gold plated shell		BODY MATERIAL: 2 Polyphenylene Sulfide with electroless nickel shell 3 Polyphenylene Sulfide with electrodeposited cadmium shell <input checked="" type="checkbox"/> 6 Polyphenylene Sulfide with gold plated shell	
<b>SIZE</b>			
XXX 009, 015, 021, 025, 031, 037, 051, 069, 100		XXX 009, 015, 021, 025, 031, 037, 051, 069, 100	
<b>CONTACTS</b>			
TYPE CONTACTS/TERMINATIONS: 11 Pin, straight, solder cup 1A Pin, straight, 24 awg solder cup 1D Pin, straight, .109" Lead Length (.018 dia) SEE NOTE 1 1E Pin, straight, .125" Lead Length (.018 dia) SEE NOTE 1 1F Pin, straight, .140" Lead Length (.018 dia) SEE NOTE 1 1G Pin, straight, .150" Lead Length (.018 dia) SEE NOTE 1 1H Pin, straight, .156" Lead Length (.018 dia) SEE NOTE 1 1K Pin, straight, .172" Lead Length (.018 dia) SEE NOTE 1 1J Pin, straight, .187" Lead Length (.018 dia) SEE NOTE 1 13 Pin, straight, .250" Lead Length (.018 dia) SEE NOTE 1 1K Pin, straight, .375" Lead Length (.018 dia) SEE NOTE 1 14 Pin, straight, .500" pigtails (.018 dia) SEE NOTE 1 15 Pin, straight, 1.000" pigtails (.018 dia) SEE NOTE 1 16 Pin, straight, crimped wire		TYPE CONTACTS/TERMINATIONS: 21 Socket, straight, solder cup 2A Socket, straight, 24 awg solder cup 2D Socket, straight, .109" Lead Length (.018 dia) 2E Socket, straight, .125" Lead Length (.018 dia) 2F Socket, straight, .140" Lead Length (.018 dia) 22 Socket, straight, .150" Lead Length (.018 dia) 2G Socket, straight, .156" Lead Length (.018 dia) 2H Socket, straight, .172" Lead Length (.018 dia) 2J Socket, straight, .187" Lead Length (.018 dia) 23 Socket, straight, .250" Lead Length (.018 dia) 2K Socket, straight, .375" Lead Length (.018 dia) 2L Socket, straight, .500" Lead Length (.018 dia) 2M Socket, straight, 1.000" Lead Length (.018 dia) 24 Socket, straight, .500" pigtails (.018 dia) SEE NOTE 1 25 Socket, straight, 1.000" pigtails (.018 dia) SEE NOTE 1 26 Socket, straight, crimped wire	
PLATING OPTIONS: 1 50 μ" Au contacts (crimp wire) 3 50 μ" Au contacts (solder cup, pigtail) 5 50 μ" Au contacts; Sn/Pb alloy terminations (pigtail) <input checked="" type="checkbox"/> 7 50 μ" Au contacts; SAC305 terminations (pigtail)		PLATING OPTIONS: 1 50 μ" Au contacts (crimp wire) 3 50 μ" Au contacts (solder cup, pigtail) 5 50 μ" Au contacts; Sn/Pb alloy terminations (pigtail) <input checked="" type="checkbox"/> 7 50 μ" Au contacts; SAC305 terminations (pigtail)	
<b>HARDWARE</b>			
STYLE OF HARDWARE: 00 None 22 Two fixed jacknut assemblies (62*) 41 Two turning jackscrews, allen head, retaining ring (81*) 42 Two long turning jackscrews, allen head, retaining ring (82*) 43 Two turning jackscrews, slot head, retaining ring (83*) 44 Two long turning jackscrews, slot head, retaining ring (84*) 45 Two turning jackscrews, allen head, captivated** (85*) 99 Keying hardware, see options below. (Body material 2 and 3 only)		STYLE OF HARDWARE: 00 None 22 Two fixed captive jacknut assemblies** (62*) 41 Two turning jackscrews, allen head, retaining ring (81*) 42 Two long turning jackscrews, allen head, retaining ring (82*) 43 Two turning jackscrews, slot head, retaining ring (83*) 44 Two long turning jackscrews, slot head, retaining ring (84*) 45 Two turning jackscrews, allen head, captivated** (85*) 99 Keying hardware, see options below. (Body material 2 and 3 only)	
POLARIZATION / WIRING: 00 None XX For wiring codes, see page MA-3 & MA-4		POLARIZATION / WIRING: 00 None XX For wiring codes, see page MA-3 & MA-4	
<b>OPTIONS</b>			
KSXX Two turning jackscrews. See page MA-6 for keying options (KJ*) KPXX Two fixed jacknuts. See page MA-6 for keying options (KN*)		KSXX Two turning jackscrews and interfacial sealing gasket. See page MA-6 for keying options (KJ*) KPXX Two fixed jacknuts and interfacial sealing gasket. See page MA-6 for keying options (KN*) 900 Interfacial sealing gasket	

\* = Use numbers or letters in parenthesis when ordering size 100.  
 \*\* = Captive hardware is factory installed and non-removable.

NOTE 1 = The leads on these contacts are soft copper suitable for forming.

= Option not RoHS compliant



# Rugged Metal I/O (Integral Shield Termination)

.050"  
9 thru 100 Contacts

**MM**

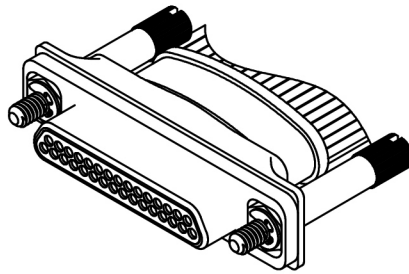

MM-2P2-031-161-44WA  
(PLUG)

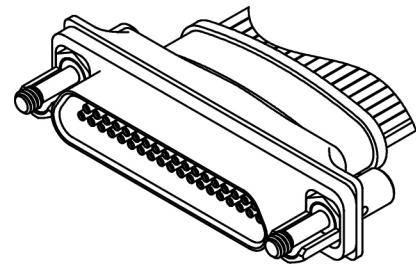

MM-2Q2-031-261-99WA-KS11  
(RECEPTACLE)

MATING MATRIX	
CONNECTOR	MATES WITH
MM-2P...	MK, ML, MM, MN receptacles
MM-2Q...	MK, ML, MM, MN plugs

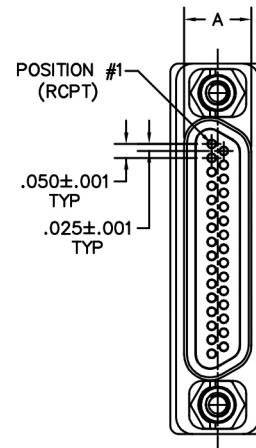
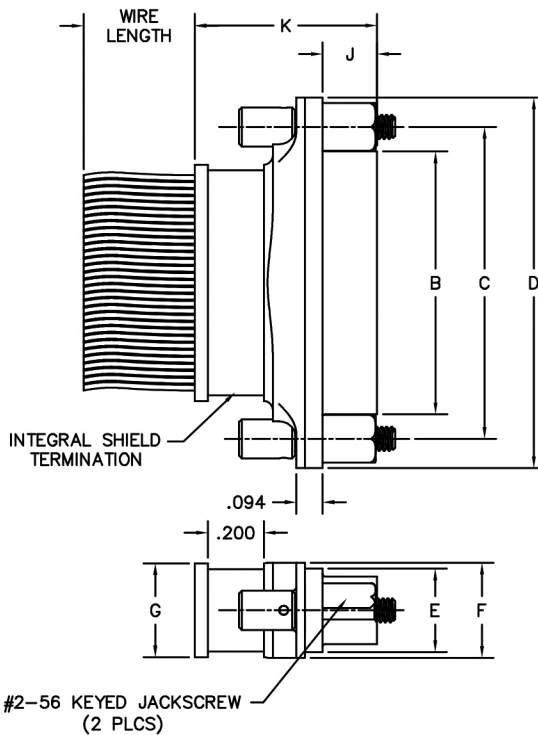
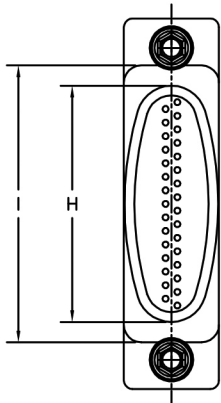

SIZE	CONTACT ROWS	A		B		C	HARDWARE	D	E	F	G	H	I	J		K		
		PLUG MAX	RCPT MAX	PLUG MAX	RCPT MAX									PLUG	RCPT	PLUG	RCPT	
9	2	.185	.251	.334	.400	.565	#2-56 UNC THD (.092 DIA THRU)	.775	.298	.340	.335	.290	.290	.440	.183	.195	.640	.652
15				.484	.550	.715		.925				.445	.590					
21				.634	.700	.865		1.075				.595	.740					
25				.734	.800	.965		1.175				.695	.840					
31				.884	.950	1.115		1.325				.845	.990					
37				1.034	1.100	1.265		1.475				.995	1.140					
51	3	.228	.294	1.384	1.450	1.615	#4-40 UNC THD (.147 DIA THRU)	1.825	.341	.380	.367	1.345	1.490	.945	1.090	1.245	1.390	
51				.984	1.050	1.215		1.425				.945	1.090					
69				1.284	1.350	1.515		1.725				1.245	1.390					
100	4	.271	.394	1.384	1.508	1.800	#4-40 UNC THD (.147 DIA THRU)	2.160	.381	.430	.417	1.457	1.522					



PLUG: MM-2P2-031-161-44WA  
 RECEPTACLE: MM-2Q2-031-261-99WA-KS11

XX-XXX-XXX-XXX-XXXX  
 SERIES SIZE HARDWARE & WIRING  
 BODY CONTACTS

**PLUG**

**SERIES**

MM .050" Rugged Metal I/O Connector

**BODY**

- 2 2-Row (Sizes 9 thru 37, 51)\*\*\*
- 3 3-Row (Sizes 51 thru 69)
- 4 4-Row (Size 100)

BODY STYLE:  
 P Plug, straight, with ears and integral shield termination

BODY MATERIAL:  
 2 Polyphenylene Sulfide with electroless nickel shell  
 3 Polyphenylene Sulfide with electrodeposited cadmium shell

**SIZE**

XXX 009, 015, 021, 025, 031, 037, 051, 069, 100

**CONTACTS**

CONTACTS/PLATING/TERMINATIONS:  
 161 Pin, straight, 50 μ" Au contacts (crimped stranded wire)

**HARDWARE & WIRING**

STYLE OF HARDWARE:  
 00 None  
 22 Two fixed jacknut assemblies (62)\*\*  
 41 Two turning jackscrews, allen head, retaining ring (81)\*\*  
 42 Two long turning jackscrews, allen head, retaining ring (82)\*\*  
 43 Two turning jackscrews, slot head, retaining ring (83)\*\*  
 44 Two long turning jackscrews, slot head, retaining ring (84)\*\*  
 45 Two turning jackscrews, allenhead,captivated\* (85)\*\*  
 99 Keying hardware, see options below

WIRING:  
 XX For wiring codes, see page MA-3 & MA-4

**OPTIONS**

KSXX Two turning jackscrews  
 See page MA-6 for keying options (KJ)\*\*  
 KPXX Two fixed jacknuts  
 See page MA-6 for keying options (KN)\*\*

**NOTES**

See page MA-5 & MA-7 for hardware dimensions.  
 Reference PTB44 for band-it termination installation

Stainless steel micro band for shield termination, shipped with each connector  
 AirBorn part number CDG10026 1/8" short, CDG17492 1/8" long  
 Band-it application tool - AirBorn part number CDG10027

\* = Captive hardware is factory installed and non-removable.  
 \*\* = Use numbers or letters in parenthesis when ordering size 100.  
 \*\*\* = 2 Row, 51 position connectors are NON MIL-SPEC interface  
 = Option not RoHS compliant

**RECEPTACLE**

**SERIES**

MM .050" Rugged Metal I/O Connector

**BODY**

- 2 2-Row (Sizes 9 thru 37, 51)\*\*\*
- 3 3-Row (Sizes 51 thru 69)
- 4 4-Row (Size 100)

BODY STYLE:  
 Q Receptacle, straight, with ears and integral shield termination

BODY MATERIAL:  
 2 Polyphenylene Sulfide with electroless nickel shell  
 3 Polyphenylene Sulfide with electrodeposited cadmium shell

**SIZE**

XXX 009, 015, 021, 025, 031, 037, 051, 069, 100

**CONTACTS**

CONTACTS/PLATING/TERMINATIONS:  
 261 Socket, straight, 50 μ" Au contacts (crimped stranded wire)

**HARDWARE & WIRING**

STYLE OF HARDWARE:  
 00 None  
 22 Two fixed jacknut assemblies (62)\*\*  
 41 Two turning jackscrews, allen head, retaining ring (81)\*\*  
 42 Two long turning jackscrews, allen head, retaining ring (82)\*\*  
 43 Two turning jackscrews, slot head, retaining ring (83)\*\*  
 44 Two long turning jackscrews, slot head, retaining ring (84)\*\*  
 45 Two turning jackscrews, allenhead,captivated\* (85)\*\*  
 99 Keying hardware, see options below

WIRING:  
 XX For wiring codes, see page MA-3 & MA-4

**OPTIONS**

900 Interfacial seal  
 KSXX Two turning jackscrews & interfacial sealing gasket  
 See page MA-6 for keying options (KJ)\*\*  
 KPXX Two fixed jacknuts & interfacial sealing gasket  
 See page MA-6 for keying options (KN)\*\*

**NOTES**

See page MA-5 & MA-7 for hardware dimensions.  
 Reference PTB44 for band-it termination installation



# Rugged Metal Solder Cup (Integral Shield Termination)

.050"  
9 thru 100 Contacts

**MM**

MATING MATRIX	
CONNECTOR	MATES WITH
MM-2P...	MK, ML, MM, MN receptacles
MM-2Q...	MK, ML, MM, MN plugs

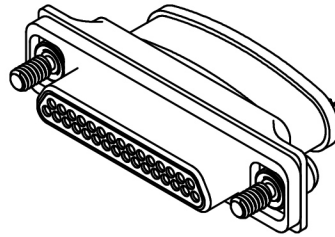
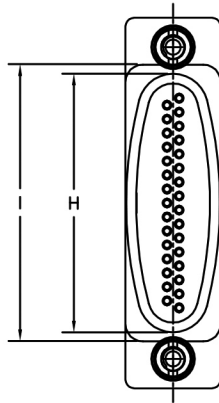

MM-2P2-031-113-4500 (PLUG)

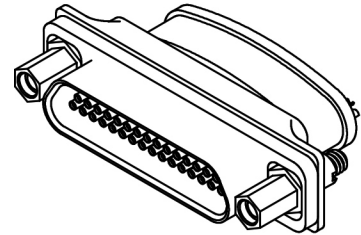

MM-2Q2-031-213-2200 (RECEPTACLE)

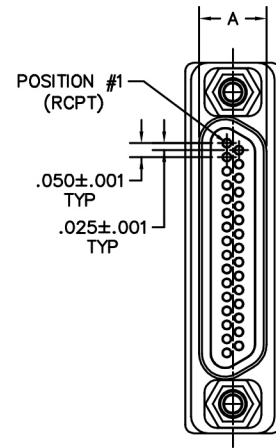
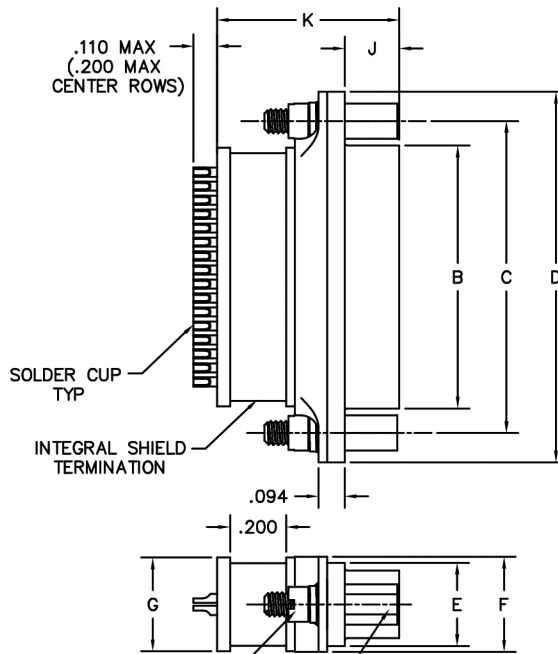

FLAT WASHER, HELICAL LOCK WASHER, SPANNER NUT, (2 PLCS)  
#2-56 JACKPOST ASSY, (2 PLCS)

DIMENSIONS																	
SIZE	CONTACT ROWS	A		B		C	HARDWARE	D	E	F	G	H	I	J		K	
		PLUG MAX	RCPT MAX	PLUG MAX	RCPT MAX									PLUG	RCPT	PLUG	RCPT
9	2	.185	.251	.334	.400	.565	#2-56 UNC THD (.092 DIA THRU)	.775	.298	.340	.335	.375	.440	.183	.195	.640	.652
15				.484	.550	.715		.925				.525	.590				
21				.634	.700	.865		1.075				.675	.740				
25				.734	.800	.965		1.175				.775	.840				
31				.884	.950	1.115		1.325				.925	.990				
37				1.034	1.100	1.265		1.475				1.075	1.140				
51				1.384	1.450	1.615		1.825				1.425	1.490				
51	3	.228	.294	.984	1.050	1.215	.341	.380	.367	1.025	1.090	.183	.195	.640	.652		
69				1.284	1.350	1.515				1.425	1.390						
100				4	.271	.394				1.384	1.508					1.800	#4-40 UNC THD (.147 DIA THRU)



**PLUG:** MM-2P2-031-113-4500

**RECEPTACLE:** MM-2Q2-031-213-2200



**PLUG**

**RECEPTACLE**

**SERIES**

MM .050" Rugged Metal Solder Cup Connector

**SERIES**

MM .050" Rugged Metal Solder Cup Connector

**BODY**

- 2 2-Row (Sizes 9 thru 37, 51)\*\*\*
- 3 3-Row (Sizes 51 thru 69)
- 4 4-Row (Size 100)

**BODY**

- 2 2-Row (Sizes 9 thru 37, 51)\*\*\*
- 3 3-Row (Sizes 51 thru 69)
- 4 4-Row (Size 100)

**BODY STYLE:**  
P Plug, straight, with ears and integral shield termination

**BODY STYLE:**  
Q Receptacle, straight, with ears and integral shield termination

**BODY MATERIAL:**  
2 Polyphenylene Sulfide with electroless nickel shell  
3 Polyphenylene Sulfide with electrodeposited cadmium shell ☒

**BODY MATERIAL:**  
2 Polyphenylene Sulfide with electroless nickel shell  
3 Polyphenylene Sulfide with electrodeposited cadmium shell ☒

**SIZE**

XXX 009, 015, 021, 025, 031, 037, 051, 069, 100

**SIZE**

XXX 009, 015, 021, 025, 031, 037, 051, 069, 100

**CONTACTS**

**CONTACTS/PLATING/TERMINATIONS:**  
113 Pin, straight, 50 μ" Au contacts, 10 μ" Au termination  
26 AWG solder cup

**CONTACTS**

**CONTACTS/PLATING/TERMINATIONS:**  
213 Socket, straight, 50 μ" Au contacts, 10 μ" Au termination  
26 AWG solder cup

**HARDWARE & WIRING**

**STYLE OF HARDWARE:**  
00 None  
22 Two fixed jacknut assemblies (62)\*\*  
41 Two turning jackscrews, allen head, retaining ring (81)\*\*  
43 Two turning jackscrews, slot head, retaining ring (83)\*\*  
45 Two turning jackscrews, allenhead,captivated\* (85)\*\*  
99 Keying hardware, see options below

**HARDWARE & WIRING**

**STYLE OF HARDWARE:**  
00 None  
22 Two fixed jacknut assemblies (62)\*\*  
41 Two turning jackscrews, allen head, retaining ring (81)\*\*  
43 Two turning jackscrews, slot head, retaining ring (83)\*\*  
45 Two turning jackscrews, allenhead,captivated\* (85)\*\*  
99 Keying hardware, see options below

**WIRING:**  
00 None

**WIRING:**  
00 None

**OPTIONS**

KPXX Two fixed jacknuts  
See page MA-6 for keying options (KN)\*\*

**OPTIONS**

900 Interfacial seal  
KPXX Two fixed jacknuts & interfacial sealing gasket  
See page MA-6 for keying options (KN)\*\*

**NOTES**

See page MA-5 & MA-7 for hardware dimensions.  
Reference PTB43 for solder cup termination  
Reference PTB44 for band-it termination installation

**NOTES**

See page MA-5 & MA-7 for hardware dimensions.  
Reference PTB43 for solder cup termination  
Reference PTB44 for band-it termination installation

Stainless steel micro band for shield termination, shipped with each connector  
AirBorn part number CDG10026 1/8" short, CDG17492 1/8" long  
Band-it application tool - AirBorn part number CDG10027

\* = Captive hardware is factory installed and non-removable.  
\*\* = Use numbers or letters in parenthesis when ordering size 100.  
\*\*\* = 2 Row, 51 position connectors are NON MIL-SPEC interface  
☒ = Option not RoHS compliant



# Cable to Cable (Jumper Assembly)

.050"

9 thru 100 Contacts

Rugged Metal

**MM**

Rugged Plastic

**MN**

MM-2J2-031-PS1-22WA  
(METAL)  
MN-2J1-031-PS1-22WA  
(PLASTIC)

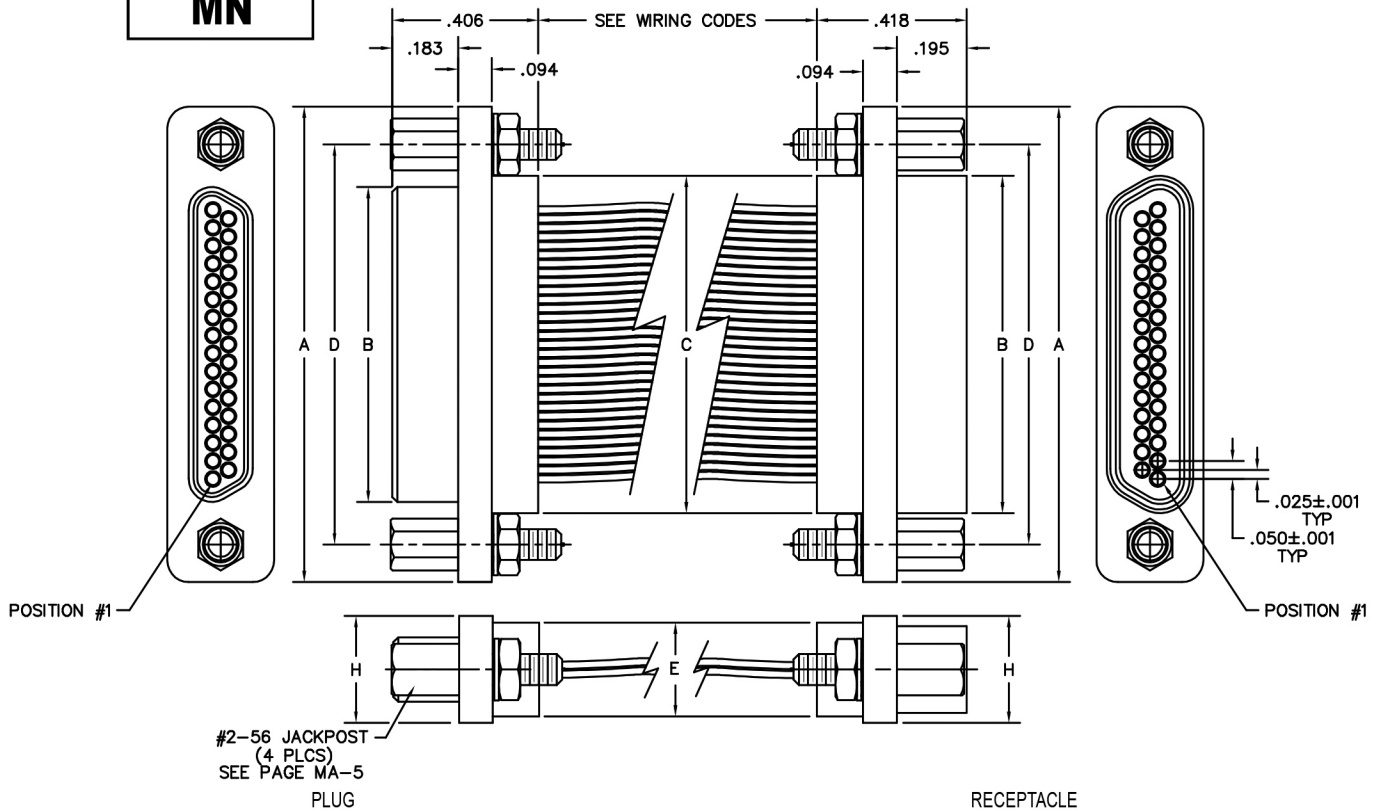
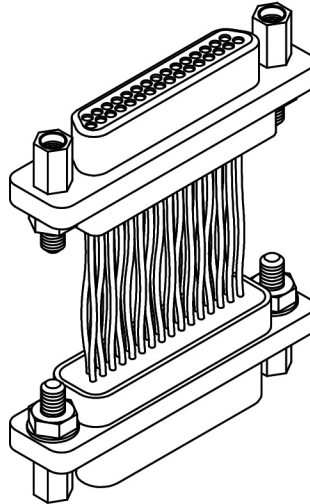

SIZE	CONTACT ROWS	DIMENSIONS					E POTTING WELL MAX	H	HARDWARE
		A	B		C	D			
			PLUG MAX	RCPT MAX					
9	2	.775	.334	.400	.390	.565	.270	.298	#2-56 UNC THD (.092 DIA THRU)
15		.925	.484	.550	.540	.715			
21		1.075	.634	.700	.690	.865			
25		1.175	.734	.800	.790	.965			
31		1.325	.884	.950	.940	1.115			
37		1.475	1.034	1.100	1.090	1.265			
51**	3	1.825	1.384	1.450	1.440	1.615	.310	.341	
51		1.425	.984	1.050	1.040	1.215			
69*		1.725	1.284	1.350	1.340	1.515			
100		2.160	1.384	1.508	1.432	1.800			

\* = 69 POSITION CONNECTORS ARE AVAILABLE IN METAL ONLY.  
\*\* = 2 ROW, 51 POSITION CONNECTORS ARE AVAILABLE IN METAL ONLY,  
(NON MIL-SPEC INTERFACE).

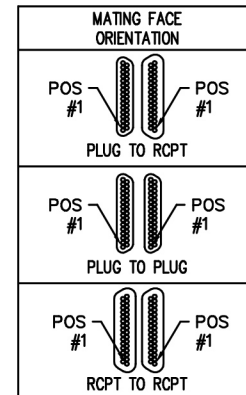



MM-2J2-031-PS1-22WA  
 MN-2J1-031-PS1-22WA  
 XX-XXX-XXX-XXX-XXXX-XXX

<b>SERIES</b>	
MM	.050" Rugged Metal I/O Connector
MN	.050" Rugged Plastic I/O Connector
(MM & MN mate with MK, ML, MM, MN assemblies)	
<b>BODY</b>	
2	2-Row (Sizes 9 thru 51****)
3	3-Row (Size 51 & 69***)
4	4-Row (Size 100)
BODY STYLE:	
J	Jumper assembly, straight, with ears
BODY MATERIAL:	
1	Polyphenylene Sulfide (MN only)
2	Polyphenylene Sulfide with electroless nickel shell
3	Polyphenylene Sulfide with electrodeposited cadmium shell <input checked="" type="checkbox"/>
4	Polyphenylene Sulfide with hard anodized black shell
5	Polyphenylene Sulfide with stainless steel shell
A	Pure Electro-Deposited Aluminum
K	Zinc Nickel Plating
T	Nickel Polymer Plating
<b>SIZE</b>	
XXX 009, 015, 021, 025, 031, 037, 051****, 069***, 100	
<b>CONTACTS</b>	
TYPE CONTACTS/TERMINATIONS:	
PP	Plug to plug
PS	Plug to receptacle
SS	Receptacle to receptacle
PLATING OPTIONS:	
1	50 μ" Au contacts (crimp wire)
<b>HARDWARE</b>	
STYLE OF HARDWARE:	
00	None
22	Four fixed jacknut assemblies (62*)
41	Four turning jackscrews, allen head, retaining ring (81*)
43	Four turning jackscrews, slot head, retaining ring (83*)
45	Four turning jackscrews, allen head, captivated** (85*)
46	Two fixed jacknuts and two turning jackscrews, allen head, uninstalled (86*)
47	Two fixed jacknuts and two turning jackscrews, slot head, uninstalled (87*)
99	Keying hardware, see options below. (Body material 2, 3 and 4 only)
POLARIZATION / WIRING:	
XX	For wiring codes, see page MA-3 & MA-4
<b>OPTIONS</b>	
KSXX	Four turning jackscrews. Receptacles supplied with interfacial sealing gasket. See page MA-6 for keying options (KJ*)
KPXX	Four fixed jacknuts. Receptacles supplied with interfacial sealing gasket. See page MA-6 for keying options (KN*)
900	Interfacial sealing gasket

\* = Use numbers or letters in parenthesis when ordering size 100.  
 \*\* = Captive hardware is factory installed and non-removable.  
 \*\*\* = 69 position connectors are available in metal only.  
 \*\*\*\* = 2 row, 51 position connectors are available in metal only (non Mil-Spec interface).  
 = Option not RoHS compliant



# Cable to Cable

.050"

9 thru 51 Contacts

Low Profile Metal

**MQ**

Low Profile Plastic

**MP**

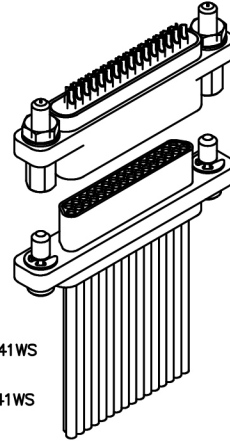

MQ-222-031-2A3-2200  
(METAL)

MP-221-031-2A3-2200  
(PLASTIC)

MQ-212-031-161-41WS  
(METAL)

MP-211-031-161-41WS  
(PLASTIC)

SEE LEAD/WIRE  
LENGTH

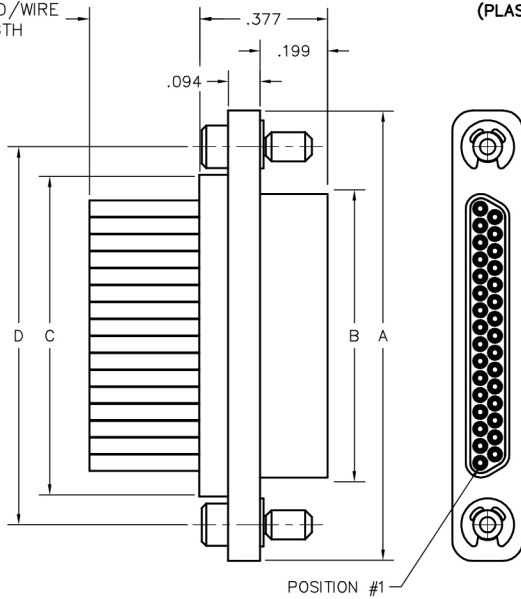

POSITION #1

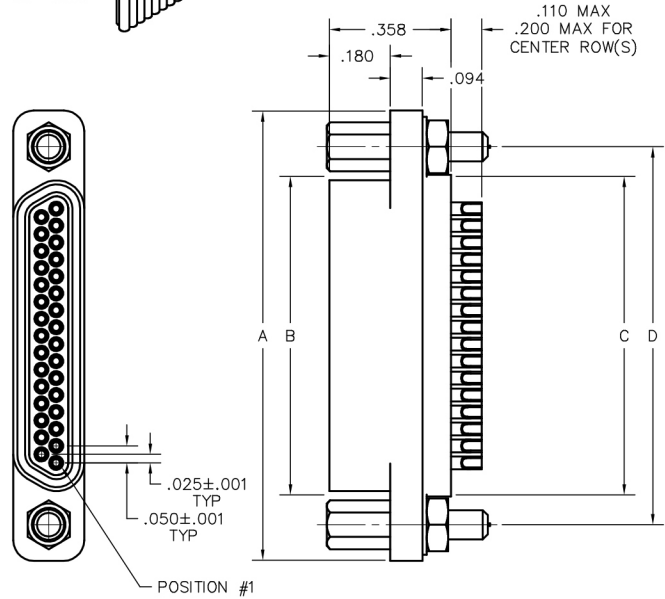

POSITION #1

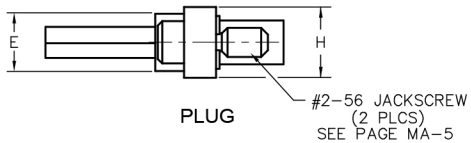

PLUG

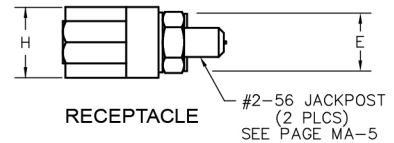

RECEPTACLE

DIMENSIONS									
SIZE	CONTACT ROWS	A	B		C	D	E	H	HARDWARE
			PLUG MAX	RCPT MAX					
9	2	.778	.292	.378	.398	.565	.173	.208	#2-56 UNC THD (.092 DIA THRU)
15		.928	.442	.528	.548	.715			
21		1.078	.592	.678	.698	.865			
25		1.178	.692	.778	.798	.965			
31		1.328	.842	.928	.948	1.115			
37		1.478	.992	1.078	1.098	1.265			
51	3	1.428	.942	1.028	1.048	1.215	.220	.250	



**PLUG:** MQ-212-031-161-41WS  
**RECEPTACLE:** MQ-222-031-2G3-4500  
**PLUG:** MP-211-031-161-41WS  
**RECEPTACLE:** MP-221-031-2G3-4500  
 XX-XXX-XXX-XXX-XXXX-XXX

PLUG		RECEPTACLE	
<b>SERIES</b>			
MQ .050" Low Profile Metal I/O Connector	MQ .050" Low Profile Metal I/O Connector	MP .050" Low Profile Plastic I/O Connector	MP .050" Low Profile Plastic I/O Connector
(MQ & MP mate with MP, MQ, MR, MS receptacles)		(MQ & MP mate with MP, MQ, MR, MS plugs)	
<b>BODY</b>			
2 2-Row (Sizes 9 thru 37)	2 2-Row (Sizes 9 thru 37)	3 3-Row (Size 51)	3 3-Row (Size 51)
<b>BODY STYLE:</b>		<b>BODY STYLE:</b>	
1 Plug, straight, with ears	2 Receptacle, straight, with ears		
<b>BODY MATERIAL:</b>		<b>BODY MATERIAL:</b>	
1 Polyphenylene Sulfide (MP only)	1 Polyphenylene Sulfide (MP only)	2 Polyphenylene Sulfide with electroless nickel shell	2 Polyphenylene Sulfide with electroless nickel shell
2 Polyphenylene Sulfide with electroless nickel shell	2 Polyphenylene Sulfide with electroless nickel shell	3 Polyphenylene Sulfide with electrodeposited cadmium shell <input checked="" type="checkbox"/>	3 Polyphenylene Sulfide with electrodeposited cadmium shell <input checked="" type="checkbox"/>
3 Polyphenylene Sulfide with electrodeposited cadmium shell <input checked="" type="checkbox"/>	3 Polyphenylene Sulfide with electrodeposited cadmium shell <input checked="" type="checkbox"/>	4 Polyphenylene Sulfide with hard anodized black shell	4 Polyphenylene Sulfide with hard anodized black shell
4 Polyphenylene Sulfide with hard anodized black shell	4 Polyphenylene Sulfide with hard anodized black shell	A Pure Electro-Deposited Aluminum	A Pure Electro-Deposited Aluminum
A Pure Electro-Deposited Aluminum	A Pure Electro-Deposited Aluminum	K Zinc Nickel Plating	K Zinc Nickel Plating
K Zinc Nickel Plating	K Zinc Nickel Plating	T Nickel Polymer Plating	T Nickel Polymer Plating
T Nickel Polymer Plating	T Nickel Polymer Plating		
<b>SIZE</b>			
XXX 009, 015, 021, 025, 031, 037, 051		XXX 009, 015, 021, 025, 031, 037, 051	
<b>CONTACTS</b>			
<b>TYPE CONTACTS/TERMINATIONS:</b>		<b>TYPE CONTACTS/TERMINATIONS:</b>	
11 Pin, straight, 26 awg solder cup	21 Socket, straight, 26 awg solder cup	2A Socket, straight, 24 awg solder cup	2A Socket, straight, 24 awg solder cup
1A Pin, straight, 24 awg solder cup	2D Socket, straight, .109" Lead Length (.018 dia) SEE NOTE 1	2D Socket, straight, .109" Lead Length (.018 dia)	2D Socket, straight, .109" Lead Length (.018 dia)
1D Pin, straight, .109" Lead Length (.018 dia) SEE NOTE 1	2E Socket, straight, .125" Lead Length (.018 dia) SEE NOTE 1	2E Socket, straight, .125" Lead Length (.018 dia)	2E Socket, straight, .125" Lead Length (.018 dia)
1E Pin, straight, .125" Lead Length (.018 dia) SEE NOTE 1	2F Socket, straight, .140" Lead Length (.018 dia) SEE NOTE 1	2F Socket, straight, .140" Lead Length (.018 dia)	2F Socket, straight, .140" Lead Length (.018 dia)
1F Pin, straight, .140" Lead Length (.018 dia) SEE NOTE 1	22 Socket, straight, .150" Lead Length (.018 dia)	22 Socket, straight, .150" Lead Length (.018 dia)	22 Socket, straight, .150" Lead Length (.018 dia)
12 Pin, straight, .150" Lead Length (.018 dia) SEE NOTE 1	2G Socket, straight, .156" Lead Length (.018 dia)	2G Socket, straight, .156" Lead Length (.018 dia)	2G Socket, straight, .156" Lead Length (.018 dia)
1G Pin, straight, .156" Lead Length (.018 dia) SEE NOTE 1	2H Socket, straight, .172" Lead Length (.018 dia) SEE NOTE 1	2H Socket, straight, .172" Lead Length (.018 dia)	2H Socket, straight, .172" Lead Length (.018 dia)
1H Pin, straight, .172" Lead Length (.018 dia) SEE NOTE 1	2J Socket, straight, .187" Lead Length (.018 dia)	2J Socket, straight, .187" Lead Length (.018 dia)	2J Socket, straight, .187" Lead Length (.018 dia)
1J Pin, straight, .187" Lead Length (.018 dia) SEE NOTE 1	23 Socket, straight, .250" Lead Length (.018 dia)	23 Socket, straight, .250" Lead Length (.018 dia)	23 Socket, straight, .250" Lead Length (.018 dia)
13 Pin, straight, .250" Lead Length (.018 dia) SEE NOTE 1	2K Socket, straight, .375" Lead Length (.018 dia)	2K Socket, straight, .375" Lead Length (.018 dia)	2K Socket, straight, .375" Lead Length (.018 dia)
1K Pin, straight, .375" Lead Length (.018 dia) SEE NOTE 1	2L Socket, straight, .500" Lead Length (.018 dia)	2L Socket, straight, .500" Lead Length (.018 dia)	2L Socket, straight, .500" Lead Length (.018 dia)
14 Pin, straight, .500" Lead Length (.018 dia) SEE NOTE 1	2M Socket, straight, 1.000" Lead Length (.018 dia)	2M Socket, straight, 1.000" Lead Length (.018 dia)	2M Socket, straight, 1.000" Lead Length (.018 dia)
15 Pin, straight, 1.000" Lead Length (.018 dia) SEE NOTE 1	24 Socket, straight, .500" Lead Length (.018 dia) SEE NOTE 1	24 Socket, straight, .500" Lead Length (.018 dia)	24 Socket, straight, .500" Lead Length (.018 dia)
16 Pin, straight, crimped wire	25 Socket, straight, 1.000" Lead Length (.018 dia) SEE NOTE 1	25 Socket, straight, 1.000" Lead Length (.018 dia)	25 Socket, straight, 1.000" Lead Length (.018 dia)
	26 Socket, straight, crimped wire	26 Socket, straight, crimped wire	26 Socket, straight, crimped wire
<b>PLATING OPTIONS:</b>		<b>PLATING OPTIONS:</b>	
1 50 μ" Au contacts (crimp wire)	1 50 μ" Au contacts (crimp wire)	3 50 μ" Au contacts (solder cup, pigtail)	3 50 μ" Au contacts (solder cup, pigtail)
3 50 μ" Au contacts (solder cup, pigtail)	3 50 μ" Au contacts (solder cup, pigtail)	5 50 μ" Au contacts; Sn/Pb alloy terminations <input checked="" type="checkbox"/>	5 50 μ" Au contacts; Sn/Pb alloy terminations <input checked="" type="checkbox"/>
5 50 μ" Au contacts; Sn/Pb alloy terminations <input checked="" type="checkbox"/>	5 50 μ" Au contacts; Sn/Pb alloy terminations <input checked="" type="checkbox"/>	7 50 μ" Au contacts; SAC305 terminations	7 50 μ" Au contacts; SAC305 terminations
7 50 μ" Au contacts; SAC305 terminations	7 50 μ" Au contacts; SAC305 terminations		
<b>HARDWARE</b>			
<b>STYLE OF HARDWARE:</b>		<b>STYLE OF HARDWARE:</b>	
00 None	00 None	22 Two fixed jacknut assemblies (62*)	22 Two fixed jacknut assemblies (62*)
22 Two fixed jacknut assemblies (62*)	22 Two fixed jacknut assemblies (62*)	41 Two turning jackscrews, allen head, retaining ring (81*)	41 Two turning jackscrews, allen head, retaining ring (81*)
41 Two turning jackscrews, allen head, retaining ring (81*)	41 Two turning jackscrews, allen head, retaining ring (81*)	42 Two long turning jackscrews, allen head, retaining ring (82*)	42 Two long turning jackscrews, allen head, retaining ring (82*)
42 Two long turning jackscrews, allen head, retaining ring (82*)	42 Two long turning jackscrews, allen head, retaining ring (82*)	43 Two turning jackscrews, slot head, retaining ring (83*)	43 Two turning jackscrews, slot head, retaining ring (83*)
43 Two turning jackscrews, slot head, retaining ring (83*)	43 Two turning jackscrews, slot head, retaining ring (83*)	44 Two long turning jackscrews, slot head, retaining ring (84*)	44 Two long turning jackscrews, slot head, retaining ring (84*)
44 Two long turning jackscrews, slot head, retaining ring (84*)	44 Two long turning jackscrews, slot head, retaining ring (84*)	45 Two turning jackscrews, allen head, captivated** (85*)	45 Two turning jackscrews, allen head, captivated** (85*)
45 Two turning jackscrews, allen head, captivated** (85*)	45 Two turning jackscrews, allen head, captivated** (85*)	99 Keying hardware, see options below. (Body material 2, 3 and 4 only)	99 Keying hardware, see options below. (Body material 2, 3 and 4 only)
99 Keying hardware, see options below. (Body material 2, 3 and 4 only)	99 Keying hardware, see options below. (Body material 2, 3 and 4 only)		
<b>POLARIZATION / WIRING</b>		<b>POLARIZATION / WIRING</b>	
00 None	00 None	XX For wiring codes, see page MA-3 & MA-4	XX For wiring codes, see page MA-3 & MA-4
XX For wiring codes, see page MA-3 & MA-4	XX For wiring codes, see page MA-3 & MA-4		
<b>OPTIONS</b>			
KSXX Two turning jackscrews. See page MA-6 for keying options	KSXX Two turning jackscrews and interfacial sealing gasket. See page MA-6 for keying options	KPXX Two fixed jacknuts. See page MA-6 for keying options	KPXX Two fixed jacknuts and interfacial sealing gasket. See page MA-6 for keying options

\*\* = Captive hardware is factory installed and non-removable.  
 = Option not RoHS compliant  
 NOTE 1 = The leads on these contacts are soft copper suitable for forming.



# Cable to Cable (Jumper Assembly)

.050"

9 thru 51 Contacts

Low Profile Metal

**MQ**

Low Profile Plastic

**MP**

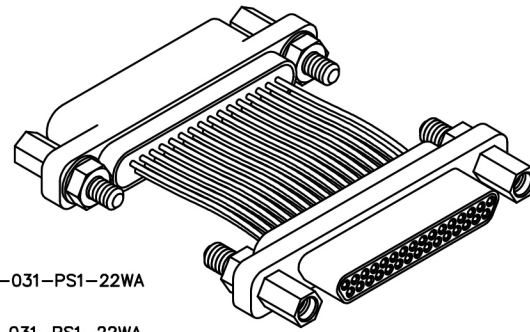

MQ-2J2-031-PS1-22WA  
(METAL)

MP-2J1-031-PS1-22WA  
(PLASTIC)

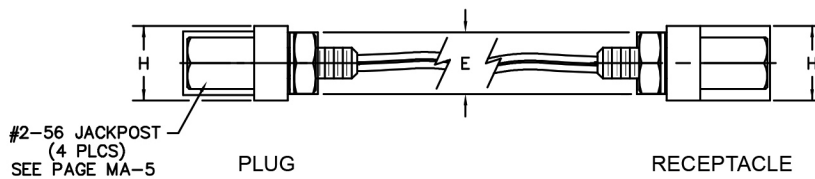
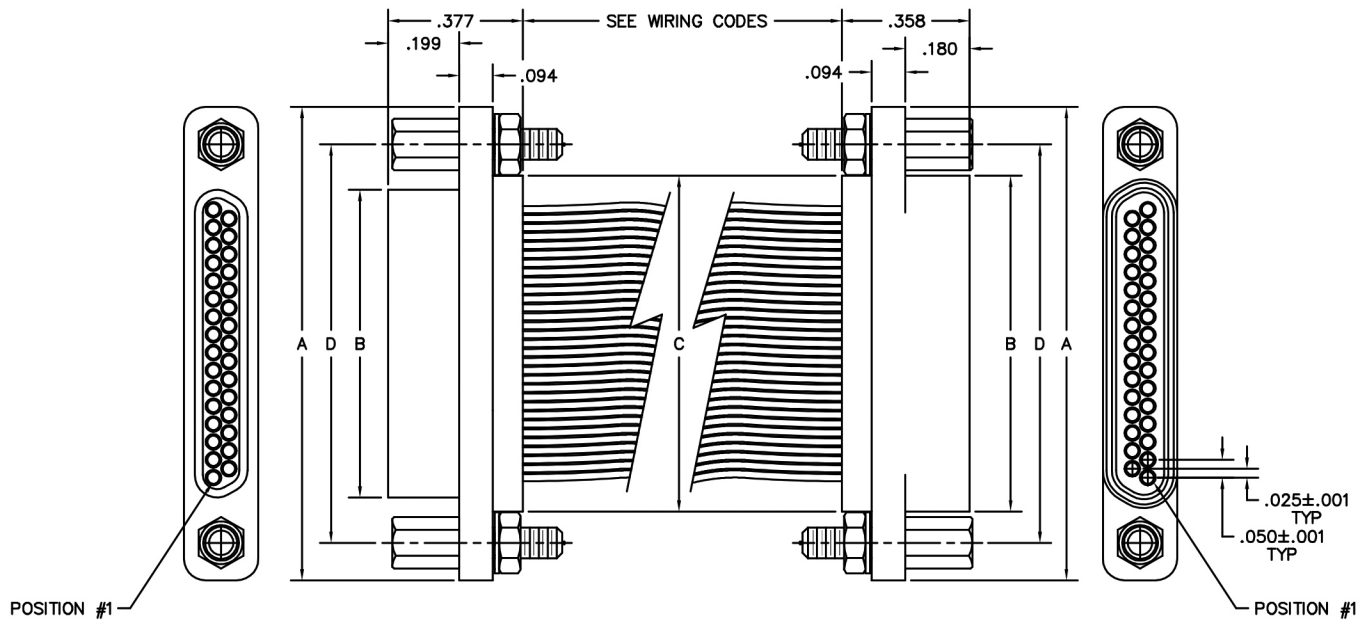

SIZE	CONTACT ROWS	DIMENSIONS						H	HARDWARE
		A	B		C	D	E		
			PLUG MAX	RCPT MAX			POTTING WELL MAX		
9	2	.778	.292	.378	.398	.565	.173	.208	#2-56 UNC THD (.092 DIA THRU)
15		.928	.442	.528	.548	.715			
21		1.078	.592	.678	.698	.865			
25		1.178	.692	.778	.798	.965			
31		1.328	.842	.928	.948	1.115			
37		1.478	.992	1.078	1.098	1.265			
51	3	1.428	.942	1.028	1.048	1.215	.220	.250	

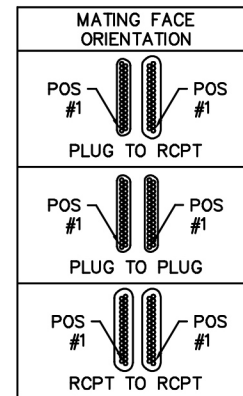



MQ- 2J2-031 - PS1-22WA  
 MP- 2J1-031 - PS1-22WA  
 XX-XXX-XXX-XXX-XXXX-XXXX

**SERIES**

MQ .050" Low Profile Metal I/O Connector  
 MP .050" Low Profile Plastic I/O Connector  
 (MQ & MP mate with MP, MQ, MR, MS receptacles)

**BODY**

2 2-Row (Sizes 9 thru 37)  
 3 3-Row (Size 51)  
 BODY STYLE:  
 J Jumper assembly, straight, with ears  
 BODY MATERIAL:  
 1 Polyphenylene Sulfide (MP only)  
 2 Polyphenylene Sulfide with electroless nickel shell  
 3 Polyphenylene Sulfide with electrodeposited cadmium shell   
 4 Polyphenylene Sulfide with hard anodized black shell  
 A Pure Electro-Deposited Aluminum  
 K Zinc Nickel Plating  
 T Nickel Polymer Plating

**SIZE**

XXX 009, 015, 021, 025, 031, 037, 051

**CONTACTS**

TYPE CONTACTS/TERMINATIONS:  
 PP Plug to plug  
 PS Plug to receptacle  
 SS Receptacle to receptacle  
 PLATING OPTIONS:  
 1 50 μ" Au contacts (crimp wire)

**HARDWARE**

STYLE OF HARDWARE:  
 00 None  
 22 Four fixed jacknut assemblies  
 41 Four turning jackscrews, allen head, retaining ring  
 43 Four turning jackscrews, slot head, retaining ring  
 45 Four turning jackscrews, allen head, captivated\*\*  
 46 Two fixed jacknuts and two turning jackscrews, allen head, uninstalled  
 47 Two fixed jacknuts and two turning jackscrews, slot head, uninstalled  
 99 Keying hardware, see options below. (Body material 2, 3 and 4 only)

POLARIZATION / WIRING:  
 XX For wiring codes, see page MA-3 & MA-4

**OPTIONS**

KSXX Four turning jackscrews. See page MA-6 for keying options  
 KPXX Four fixed jacknuts. See page MA-6 for keying options

\*\* = Captive hardware is factory installed and non-removable.  
 = Option not RoHS compliant



# Right Angle Boardmount (Narrow Footprint)

.050"  
9 thru 100 Contacts

**MK, ML**

MATING MATRIX	
CONNECTOR	MATES WITH
MK-25...	MK, ML, MM, MN receptacles
ML-25...	MK, ML, MM, MN receptacles
MK-26..	MK, ML, MM, MN plugs
ML-26..	MK, ML, MM, MN plugs

MK-252-031-335-220S  
(PLUG)

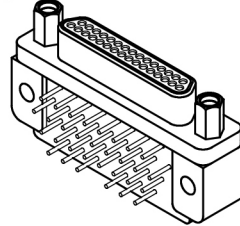

MK-262-031-445-220S  
(RCPT)

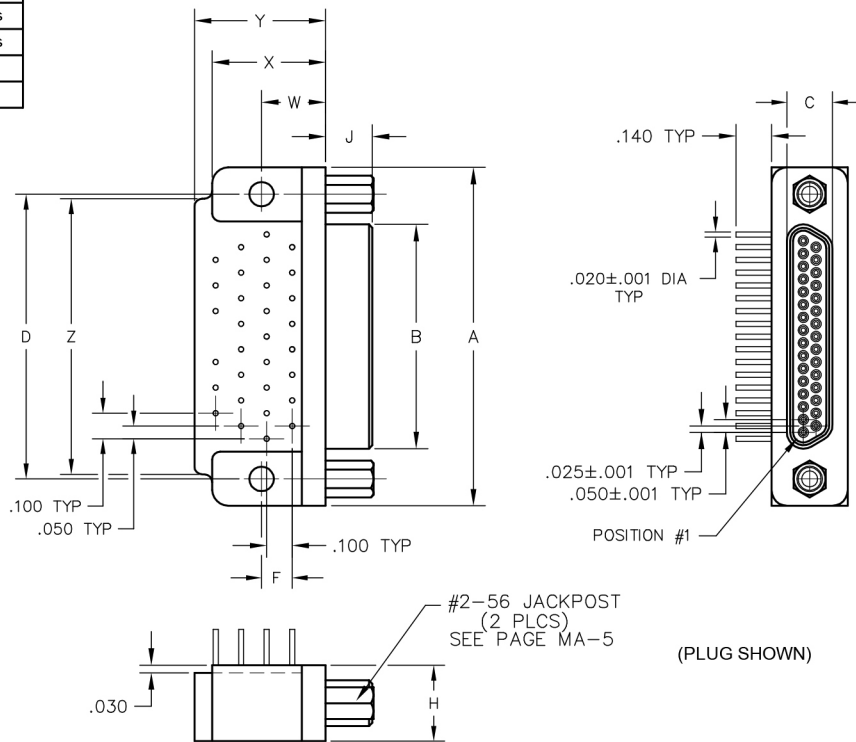
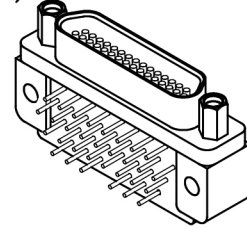

DIMENSIONS																		
SIZE	CONTACT ROWS	A	B		C		D	F	H	J		W	X MAX	Y MAX	Z	HARDWARE	MOUNTING HOLE	
			PLUG MAX	RCPT MAX	PLUG MAX	RCPT MAX				PLUG	RCPT							
9	2	.775	.334	.400	.185	.251	.565	.020	.298	.183	.195	.250	.420	.420	.775	#2-56 UNC THD	.096 DIA OR #2-56 UNC THREADED INSERT	
15		.925	.484	.550			.715	.120										.925
21		1.075	.634	.700			.865	.120										1.075
25		1.175	.734	.800			.965	.120										1.175
31		1.325	.884	.950			1.115	.120										1.325
37		1.475	1.034	1.100			1.265	.120										1.475
51	3	1.425	.984	1.050	.228	.294	1.215	.150	.341	.300	.430	.650	1.220	.755	1.450	#4-40 UNC THD	.125 DIA #2-56 UNC INSERT #4-40 UNC INSERT	
69		1.725	1.284	1.350			1.515	.150										1.725
100		2.160	1.384	1.508			.271	.394										1.800



**PLUG:** MK-252-031-335-220S

**RECEPTACLE:** MK-262-031-445-220S

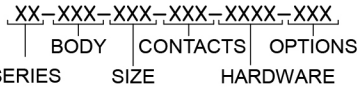

**PLUG**

**RECEPTACLE**

**SERIES**

MK .050" Rugged Metal PC Board Mount Connector  
 ML .050" Rugged Plastic PC Board Mount Connector  
 (MK & ML mate with MK, ML, MM, MN, receptacles)

**SERIES**

MK .050" Rugged Metal PC Board Mount Connector  
 ML .050" Rugged Plastic PC Board Mount Connector  
 (MK & ML mate with MK, ML, MM, MN plugs)

**BODY**

- 2 2-Row (Sizes 9 thru 37)
  - 3 3-Row (Size 51 & 69\*\*\*)
  - 4 4-Row (Size 100)
- BODY STYLE:**
- 5 Plug, right angle, narrow footprint, w/ mounting holes
- BODY MATERIAL:**
- 1 Polyphenylene Sulfide (ML only)
  - 2 Electroless nickel shell w/ PPS insulator
  - 3 Electrodeposited cadmium shell w/ PPS insulator
  - 4 Hard anodized black shell w/ PPS insulator
  - 5 Stainless steel shell w/ PPS insulator
  - A Pure Electro-Deposited Aluminum
  - K Zinc Nickel Plating
  - T Nickel Polymer Plating

**BODY**

- 2 2-Row (Sizes 9 thru 37)
  - 3 3-Row (Size 51 & 69\*\*\*)
  - 4 4-Row (Size 100)
- BODY STYLE:**
- 6 Receptacle, right angle, narrow footprint, w/ mounting holes
- BODY MATERIAL:**
- 1 Polyphenylene Sulfide (ML only)
  - 2 Electroless nickel shell w/ PPS insulator
  - 3 Electrodeposited cadmium shell w/ PPS insulator
  - 4 Hard anodized black shell w/ PPS insulator
  - 5 Stainless steel shell w/ PPS insulator
  - A Pure Electro-Deposited Aluminum
  - K Zinc Nickel Plating
  - T Nickel Polymer Plating

**SIZE**

XXX 009, 015, 021, 025, 031, 037, 051, 069\*\*\*, 100

**SIZE**

XXX 009, 015, 021, 025, 031, 037, 051, 069\*\*\*, 100

**CONTACTS**

- TYPE CONTACTS/TERMINATIONS:**
- 32 Pin, right angle, PCB leads, .109"
  - 33 Pin, right angle, PCB leads, .140"
  - 34 Pin, right angle, PCB leads, .172"
- PLATING OPTIONS:**
- 3 50 µ" Au contacts: Au terminations
  - 5 50 µ" Au contacts: Sn/Pb alloy terminations
  - 7 50 µ" Au contacts: SAC305 terminations

**CONTACTS**

- TYPE CONTACTS/TERMINATIONS:**
- 43 Socket, right angle, PCB leads, .109"
  - 44 Socket, right angle, PCB leads, .140"
  - 45 Socket, right angle, PCB leads, .172"
- PLATING OPTIONS:**
- 3 50 µ" Au contacts: Au terminations
  - 5 50 µ" Au contacts: Sn/Pb alloy terminations
  - 7 50 µ" Au contacts: SAC305 terminations

**HARDWARE**

- STYLE OF HARDWARE:**
- 00 None
  - 22 Two fixed jacknuts (62\*)
  - 41 Two turning jackscrews, allen head, retaining ring\*\*\*\*(81\*)
  - 99 Keying hardware, see options below (Body material 2, 3 and 4 only)
- POLARIZATION / WIRING:**
- 0R Reversed body polarization
  - 0S Standard body polarization

**HARDWARE**

- STYLE OF HARDWARE:**
- 00 None
  - 22 Two fixed jacknuts (62\*)
  - 41 Two turning jackscrews, allen head, retaining ring\*\*\*\*(81\*)
  - 99 Keying hardware, see options below (Body material 2, 3 and 4 only)
- POLARIZATION / WIRING:**
- 0R Reversed body polarization
  - 0S Standard body polarization

**OPTIONS**

- KPXX Two fixed jacknuts (KN\*)
- 94P Mil-Spec footprint (size 100 only), standard body polarization
- 0B7 #2-56 threaded inserts, standard body polarization
- 0BJ Mil-Spec footprint (size 100 only) with #2-56 threaded inserts, standard body polarization
- 0H7 #4-40 threaded inserts (size 100 only), standard body polarization
- 0H6 Mil-Spec footprint (size 100 only) with #4-40 threaded inserts, standard body polarization

**OPTIONS**

- KPXX Two fixed jacknuts (KN\*) and interfacial sealing gasket.
- 900 Interfacial sealing gasket
- 0B7 #2-56 Threaded inserts and interfacial sealing gasket standard body polarization
- 0H7 #4-40 threaded inserts (size 100 only), and interfacial sealing gasket, standard body polarization

**NOTES**

See page MA-6 for keying options  
 \* = Use numbers in parenthesis when ordering size 100.  
 \*\*\* = 69 position connectors are available in metal only.  
 \*\*\*\* = Connector body has no mounting holes.  
 = Option not RoHS compliant

**NOTES**

See page MA-6 for keying options  
 \* = Use numbers in parenthesis when ordering size 100.  
 \*\*\* = 69 position connectors are available in metal only.  
 \*\*\*\* = Connector body has no mounting holes.  
 x = Option not RoHS compliant



# Right Angle Boardmount (Thru Clearance Cut)

.050"  
9 thru 100 Contacts

**MK**

MATING MATRIX	
CONNECTOR	MATES WITH
MK-2R...	MK, ML, MM, MN receptacles
MK-2S...	MK, ML, MM, MN plugs

MK-2R2-031-335-220S (PLUG)

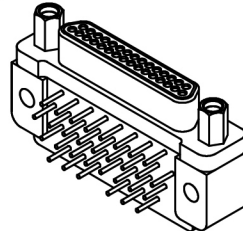

MK-2S2-031-445-220S (RCPT)

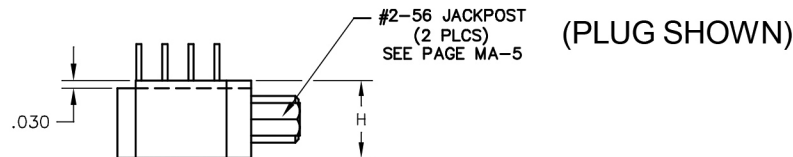
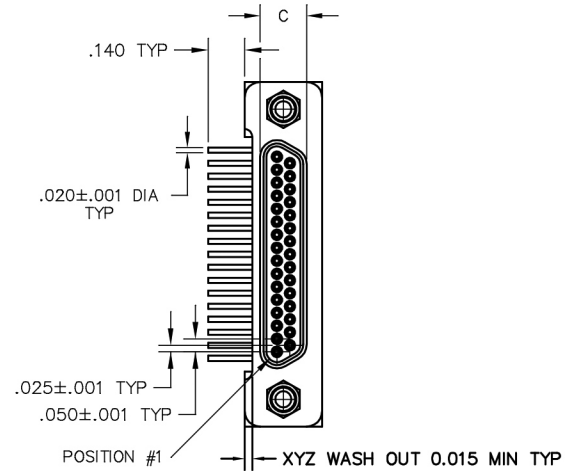
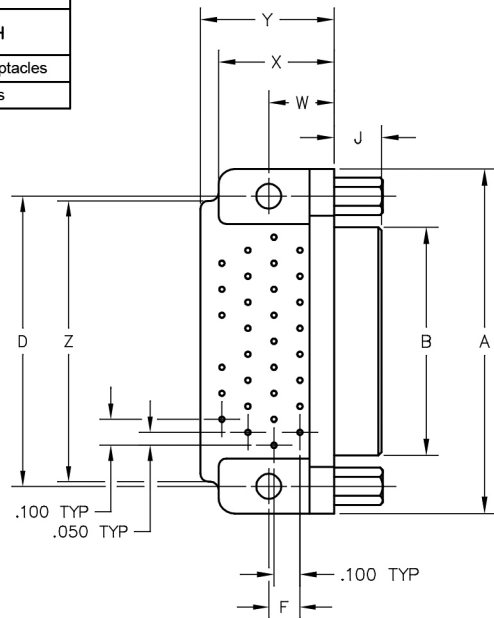
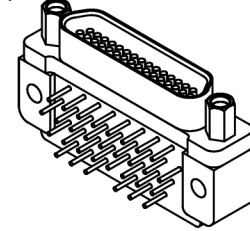

SIZE	CONTACT ROWS	DIMENSIONS																
		A	B		C		D	F	H	J		W	X MAX	Y MAX	Z	HARDWARE	MOUNTING HOLE	
			PLUG MAX	RCPT MAX	PLUG MAX	RCPT MAX				PLUG	RCPT							
9	2	.775	.334	.400	.185	.251	.565	.020	.298	.183	.195	.250	.420	.420	.775	#2-56 UNC THD	.096 DIA OR #2-56 UNC THREADED INSERT	
15		.925	.484	.550			.715											.925
21		1.075	.634	.700			.865	.120										1.075
25		1.175	.734	.800			.965											1.175
31		1.325	.884	.950			1.115											1.080
37	1.475	1.034	1.100	1.265			1.180											
51	3	1.425	.984	1.050	.228	.294	1.215	.150	.341	.300	.430	.650	1.220	.430	#4-40 UNC THD	.125 DIA #2-56 UNC INSERT #4-40 UNC INSERT		
69		1.725	1.284	1.350			1.515						.755				1.450	
100	4	2.160	1.384	1.508	.271	.394	1.800	.200	.384	.400	.590	1.000	1.810					



**PLUG:** MK-2R2-031-335-220S  
**RECEPTACLE:** MK-2S2-031-445-220S  
 XX-XXX-XXX-XXX-XXXX-XXX  
 | BODY | CONTACTS | OPTIONS  
 SERIES SIZE HARDWARE

**PLUG**

**RECEPTACLE**

**SERIES**

**SERIES**

MK .050" Rugged Metal PC Board Mount Connector  
(MK mates with MK, ML, MM, MN, receptacles)

MK .050" Rugged Metal PC Board Mount Connector  
(MK mates with MK, ML, MM, MN plugs)

**BODY**

**BODY**

- 2 2-Row (Sizes 9 thru 37)
- 3 3-Row (Size 51 & 69)
- 4 4-Row (size 100 only)

- 2 2-Row (Sizes 9 thru 37)
- 3 3-Row (Size 51 & 69)
- 4 4-Row (Size 100 only)

**BODY STYLE:** Thru Cut  
 R Plug, right angle (thru clearance cut), narrow footprint, w/ mounting holes

**BODY STYLE:** Thru Cut  
 S Receptacle, right angle (thru clearance cut), narrow footprint, w/ mounting holes

- BODY MATERIAL:**
- 2 Electroless nickel shell w/ PPS insulator
  - 3 Electrodeposited cadmium shell w/ PPS insulator
  - 4 Hard anodized black shell w/ PPS insulator
  - 5 Stainless steel shell w/ PPS insulator
  - A Pure Electro-Deposited Aluminum
  - K Zinc Nickel Plating
  - T Nickel Polymer Plating

- BODY MATERIAL:**
- 2 Electroless nickel shell w/ PPS insulator
  - 3 Electrodeposited cadmium shell w/ PPS insulator
  - 4 Hard anodized black shell w/ PPS insulator
  - 5 Stainless steel shell w/ PPS insulator
  - A Pure Electro-Deposited Aluminum
  - K Zinc Nickel Plating
  - T Nickel Polymer Plating

**SIZE**

**SIZE**

XXX 009, 015, 021, 025, 031, 037, 051, 069, 100

XXX 009, 015, 021, 025, 031, 037, 051, 069, 100

**CONTACTS**

**CONTACTS**

- TYPE CONTACTS/TERMINATIONS:**
- 32 Pin, right angle, PCB leads, .109"
  - 33 Pin, right angle, PCB leads, .140"
  - 34 Pin, right angle, PCB leads, .172"

- TYPE CONTACTS/TERMINATIONS:**
- 43 Socket, right angle, PCB leads, .109"
  - 44 Socket, right angle, PCB leads, .140"
  - 45 Socket, right angle, PCB leads, .172"

- PLATING OPTIONS:**
- 3 50 μ" Au contacts: Au terminations
  - 5 50 μ" Au contacts; Sn/Pb alloy terminations
  - 7 50 μ" Au contacts; SAC305 terminations

- PLATING OPTIONS:**
- 3 50 μ" Au contacts: Au terminations
  - 5 50 μ" Au contacts; Sn/Pb alloy terminations
  - 7 50, u" Au contacts; SAC305 terminations

**HARDWARE**

**HARDWARE**

- STYLE OF HARDWARE:**
- 00 None
  - 22 Two fixed jacknuts (62)
  - 41 Two turning jackscrews, allen head, retaining ring\*\*\*\* (81)
  - 99 Keying hardware, see options below (Body material 2, 3 and 4 only)

- STYLE OF HARDWARE:**
- 00 None
  - 22 Two fixed jacknuts (62)
  - 41 Two turning jackscrews, allen head, retaining ring\*\*\*\* (81)
  - 99 Keying hardware, see options below (Body material 2, 3 and 4 only)

- POLARIZATION / WIRING:**
- 0R Reversed body polarization\*\*
  - 0S Standard body polarization

- POLARIZATION / WIRING:**
- 0R Reversed body polarization\*\*
  - 0S Standard body polarization

**OPTIONS**

**OPTIONS**

- KPXX Two fixed jacknuts (KN\*)
- 94P Mil-Spec footprint (size 100 only), standard body polarization
- 0B7 #2-56 threaded inserts, standard body polarization
- 0BJ Mil-Spec footprint (size 100 only) with #2-56 threaded inserts, standard body polarization
- 0H7 #4-40 threaded inserts (size 100 only), standard body polarization
- 0H6 Mil-Spec footprint (size 100 only) with #4-40 threaded inserts, standard body polarization

- KPXX Two fixed jacknuts (KN\*) and interfacial sealing gasket.
- 900 Interfacial sealing gasket
- 0B7 #2-56 Threaded inserts and interfacial sealing gasket standard body polarization
- 0H7 #4-40 threaded inserts (size 100 only), and interfacial sealing gasket, standard body polarization

**NOTES**

**NOTES**

See page MA-6 for keying options  
 \* = Use numbers in parenthesis when ordering size 100.  
 \*\* = 100 position connector standard body polarization only.  
 \*\*\*\* = Connector body has no mounting holes.  
 = Option not RoHS compliant

See page MA-6 for keying options  
 \* = Use numbers in parenthesis when ordering size 100.  
 \*\* = 100 position connector standard body polarization only.  
 \*\*\*\* = Connector body has no mounting holes.  
 = Option not RoHS compliant



# Right Angle Boardmount (Blind Clearance Cut)

.050"  
9 thru 100 Contacts



MATING MATRIX	
CONNECTOR	MATES WITH
MK-2T...	MK, ML, MM, MN receptacles
MK-2V...	MK, ML, MM, MN plugs

MK-2T2-031-335-220S (PLUG)

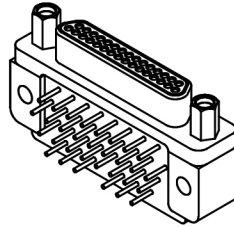

MK-2V2-031-445-220S (RCPT)

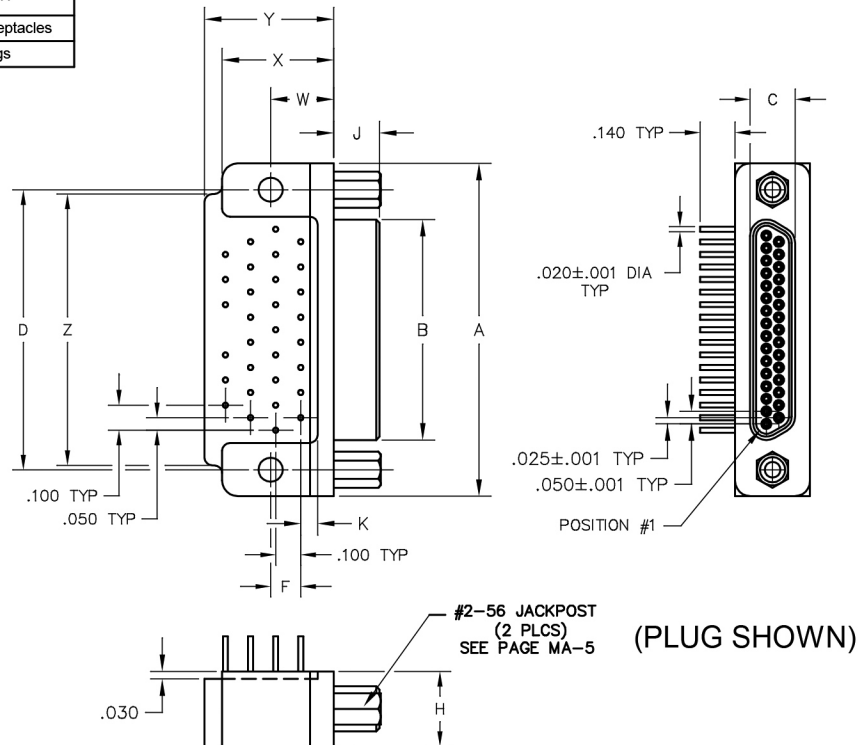
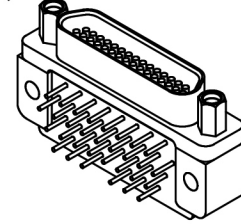

DIMENSIONS																									
SIZE	CONTACT ROWS	A	B		C		D	F	H	J		K	W	X MAX	Y MAX	Z	HARDWARE	MOUNTING HOLE							
			PLUG MAX	RCPT MAX	PLUG MAX	RCPT MAX				PLUG	RCPT														
9	2	.775	.334	.400	.185	.251	.565	.020	.298	.183	.195	.067	.250	.420	.420	1.075	#2-56 UNC THD	.096 DIA OR #2-56 UNC THREADED INSERT							
15		.925	.484	.550			.715	.120											1.115	1.080					
21		1.075	.634	.700			.865														.450	.520	1.180		
25		1.175	.734	.800			.965																	.650	1.220
31		1.325	.884	.950			1.115																		
37	1.475	1.034	1.100	1.265	.137	.400	.590	1.000	1.810	#4-40 UNC THD	.125 DIA #2-56 UNC INSERT #4-40 UNC INSERT														
51	3	1.425	.984	1.050								.228	.294	1.215	.150	.341	.087	.300	.430	.755	1.450				
69		1.725	1.284	1.350										1.515	.200	.384									
100	4	2.160	1.384	1.508	.271	.394	1.800	.200	.384																



**PLUG:** MK-2T2-031-335-220S  
**RECEPTACLE:** MK-2V2-031-445-220S  
 XX-XXX-XXX-XXX-XXXX-XXX  
 | BODY | CONTACTS | OPTIONS  
 SERIES SIZE HARDWARE

**PLUG**

**RECEPTACLE**

**SERIES**

MK .050" Rugged Metal PC Board Mount Connector  
(MK mates with MK, ML, MM, MN, receptacles)

**SERIES**

MK .050" Rugged Metal PC Board Mount Connector  
(MK mates with MK, ML, MM, MN plugs)

**BODY**

2 2-Row (Sizes 9 thru 37)  
 3 3-Row (Size 51 & 69)  
 4 4-Row (Size 100)  
 BODY STYLE: Blind Cut  
 T Plug, right angle (blind clearance cut), narrow footprint, w/ mounting holes  
 BODY MATERIAL:  
 2 Electroless nickel shell w/ PPS insulator  
 3 Electrodeposited cadmium shell w/ PPS insulator   
 4 Hard anodized black shell w/ PPS insulator  
 5 Stainless steel shell w/ PPS insulator  
 A Pure Electro-Deposited Aluminum  
 K Zinc Nickel Plating  
 T Nickel Polymer Plating

**BODY**

2 2-Row (Sizes 9 thru 37)  
 3 3-Row (Size 51 & 69)  
 4 4-Row (Size 100)  
 BODY STYLE: Blind Cut  
 V Receptacle, right angle (blind clearance cut), narrow footprint, w/ mounting holes  
 BODY MATERIAL:  
 2 Electroless nickel shell w/ PPS insulator  
 3 Electrodeposited cadmium shell w/ PPS insulator   
 4 Hard anodized black shell w/ PPS insulator  
 5 Stainless steel shell w/ PPS insulator  
 A Pure Electro-Deposited Aluminum  
 K Zinc Nickel Plating  
 T Nickel Polymer Plating

**SIZE**

XXX 009, 015, 021, 025, 031, 037, 051, 069, 100

**SIZE**

XXX 009, 015, 021, 025, 031, 037, 051, 069, 100

**CONTACTS**

TYPE CONTACTS/TERMINATIONS:  
 32 Pin, right angle, PCB leads, .109"  
 33 Pin, right angle, PCB leads, .140"  
 34 Pin, right angle, PCB leads, .172"  
 PLATING OPTIONS:  
 3 50 μ" Au contacts; Au terminations  
 5 50 μ" Au contacts; Sn/Pb alloy terminations   
 7 50 μ" Au contacts; SAC305 terminations

**CONTACTS**

TYPE CONTACTS/TERMINATIONS:  
 43 Socket, right angle, PCB leads, .109"  
 44 Socket, right angle, PCB leads, .140"  
 45 Socket, right angle, PCB leads, .172"  
 PLATING OPTIONS:  
 3 50 μ" Au contacts; Au terminations  
 5 50 μ" Au contacts; Sn/Pb alloy terminations   
 7 50, u" Au contacts; SAC305 terminations

**HARDWARE**

STYLE OF HARDWARE:  
 00 None  
 22 Two fixed jacknuts (62\*)  
 41 Two turning jackscrews, allen head, retaining ring\*\*\*\*(81\*)  
 99 Keying hardware, see options below (Body material 2, 3 and 4 only)  
 POLARIZATION / WIRING:  
 0R Reversed body polarization  
 0S Standard body polarization

**HARDWARE**

STYLE OF HARDWARE:  
 00 None  
 22 Two fixed jacknuts (62\*)  
 41 Two turning jackscrews, allen head, retaining ring\*\*\*\*(81\*)  
 99 Keying hardware, see options below (Body material 2, 3 and 4 only)  
 POLARIZATION / WIRING:  
 0R Reversed body polarization  
 0S Standard body polarization

**OPTIONS**

KPXX Two fixed jacknuts (KN\*)  
 94P Mil-Spec footprint (size 100 only), standard body polarization  
 0B7 #2-56 threaded inserts, standard body polarization  
 0BJ Mil-Spec footprint (size 100 only) with #2-56 threaded inserts, standard body polarization  
 0H7 #4-40 threaded inserts (size 100 only), standard body polarization  
 0H6 Mil-Spec footprint (size 100 only) with #4-40 threaded inserts, standard body polarization

**OPTIONS**

KPXX Two fixed jacknuts (KN\*) and interfacial sealing gasket.  
 900 Interfacial sealing gasket  
 0B7 #2-56 Threaded inserts and interfacial sealing gasket, standard body polarization  
 0H7 #4-40 threaded inserts (size 100 only), and interfacial sealing gasket, standard body polarization

**NOTES**

See page MA-6 for keying options  
 \* = Use numbers in parenthesis when ordering size 100.  
 \*\*\*\* = Connector body has no mounting holes.  
 = Option not RoHS compliant

**NOTES**

See page MA-6 for keying options  
 \* = Use numbers in parenthesis when ordering size 100.  
 \*\*\*\* = Connector body has no mounting holes.  
 = Option not RoHS compliant



# Board (Narrow Footprint) to Flex Cable

.050"

9 thru 100 Contacts

Rugged Board Mount

**MK, ML**

Flex Cable

**MK, ML**

MK-253-031-335-410S  
(METAL)

ML-251-031-335-410S  
(PLASTIC)

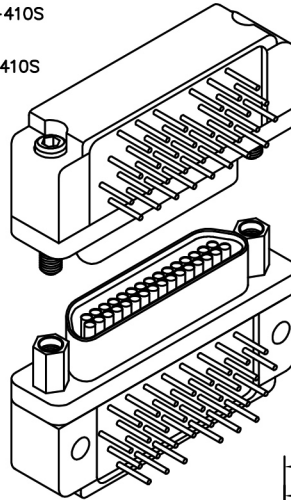

MK-263-031-445-220S  
(METAL)

ML-261-031-445-220S  
(PLASTIC)

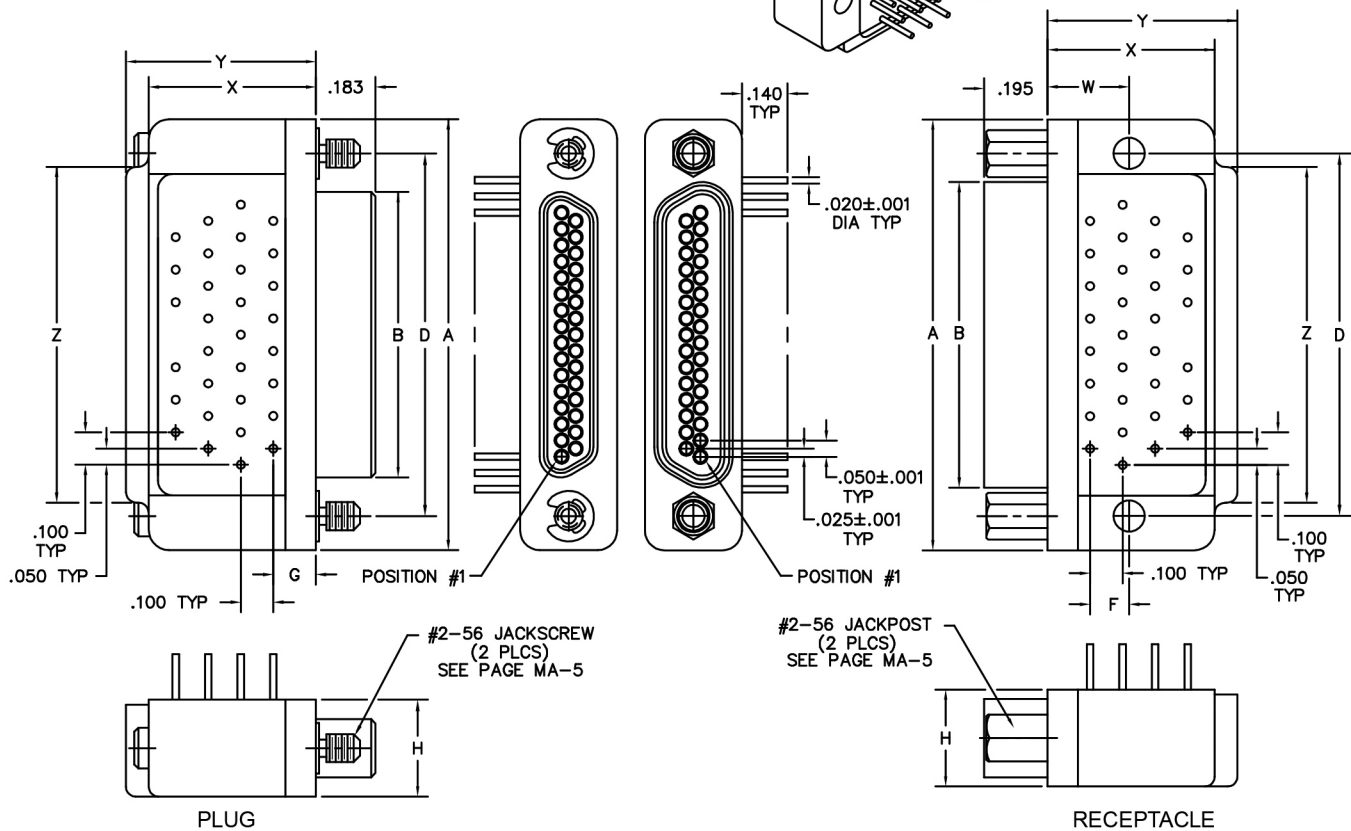

SIZE	CONTACT ROWS	A	B		D	F	G	H	W	X MAX	Y MAX	Z	HARDWARE	MOUNTING HOLE
			PLUG MAX	RCPT MAX										
9	2	.775	.334	.400	.565	.020	.230	.298	.250	.420	.420	.775	#2-56 UNC THD	.096 DIA OR #2-56 UNC THREADED INSERT
15		.925	.484	.550	.715	.120	.130					.925		
21		1.075	.634	.700	.865							1.075		
25		1.175	.734	.800	.965							1.175		
31		1.325	.884	.950	1.115							1.080		
37	1.475	1.034	1.100	1.265	1.180									
51	3	1.425	.984	1.050	1.215	.150	.150	.341	.300	.430	.650	1.220	#4-40 UNC THD	.125 DIA OR #2-56 UNC THREADED INSERT
69*		1.725	1.284	1.350	1.515						.755			
100	4	2.160	1.384	1.508	1.800	.200	.200	.384	.400	.590	1.000	1.810		

\* = 69 POSITION CONNECTORS ARE AVAILABLE IN METAL ONLY.



**PLUG:** MK-253-031-335-410S  
**RECEPTACLE:** MK-263-031-445-220S  
**PLUG:** ML-251-031-335-410S  
**RECEPTACLE:** ML-261-031-445-220S  
 XX-XXX-XXX-XXX-XXXX-XXX

**PLUG**

**RECEPTACLE**

<b>SERIES</b>	
MK .050" Rugged Metal PC Board Mount Connector ML .050" Rugged Plastic PC Board Mount Connector (MK & ML mate with MK, ML, MM, MN receptacles)	MK .050" Rugged Metal PC Board Mount Connector ML .050" Rugged Plastic PC Board Mount Connector (MK & ML mate with MK, ML, MM, MN plugs)
<b>BODY</b>	
2 2-Row (Sizes 9 thru 37) 3 3-Row (Size 51 & 69***) 4 4-Row (Size 100)	2 2-Row (Sizes 9 thru 37) 3 3-Row (Size 51 & 69***) 4 4-Row (Size 100)
<b>BODY STYLE:</b> 5 Plug, right angle, narrow footprint, w/ mtg holes	<b>BODY STYLE:</b> 6 Receptacle, right angle, narrow footprint, w/ mtg holes
<b>BODY MATERIAL:</b> 1 Polyphenylene Sulfide (ML only) 2 Electroless nickel shell w/ PPS insulator 3 Electrodeposited cadmium shell w/ PPS insulator <input checked="" type="checkbox"/> 4 Hard anodized black shell w/ PPS insulator 5 Stainless steel shell w/ PPS insulator A Pure Electro-Deposited Aluminum K Zinc Nickel Plating T Nickel Polymer Plating	<b>BODY MATERIAL:</b> 1 Polyphenylene Sulfide (ML only) 2 Electroless nickel shell w/ PPS insulator 3 Electrodeposited cadmium shell w/ PPS insulator <input checked="" type="checkbox"/> 4 Hard anodized black shell w/ PPS insulator 5 Stainless steel shell w/ PPS insulator A Pure Electro-Deposited Aluminum K Zinc Nickel Plating T Nickel Polymer Plating
<b>SIZE</b>	
XXX 009, 015, 021, 025, 031, 037, 051, 069***, 100	XXX 009, 015, 021, 025, 031, 037, 051, 069***, 100
<b>CONTACTS</b>	
<b>TYPE CONTACTS/TERMINATIONS:</b> 32 Pin, right angle, PCB leads, .109" 33 Pin, right angle, PCB leads, .140" 34 Pin, right angle, PCB leads, .172"	<b>TYPE CONTACTS/TERMINATIONS:</b> 43 Socket, right angle, PCB leads, .109" 44 Socket, right angle, PCB leads, .140" 45 Socket, right angle, PCB leads, .172"
<b>PLATING OPTIONS:</b> 3 50 μ" Au contacts: Au terminations 5 50 μ" Au contacts: Sn/Pb alloy terminations <input checked="" type="checkbox"/> 7 50 μ" Au contacts: SAC305 terminations	<b>PLATING OPTIONS:</b> 3 50 μ" Au contacts: Au terminations 5 50 μ" Au contacts: Sn/Pb alloy terminations <input checked="" type="checkbox"/> 7 50 μ" Au contacts: SAC305 terminations
<b>HARDWARE</b>	
<b>STYLE OF HARDWARE:</b> 00 None 22 Two fixed jacknut assemblies (62*) 41 Two turning jackscrews, allen head, retaining ring**** (81*)	<b>STYLE OF HARDWARE:</b> 00 None 22 Two fixed jacknut assemblies (62*) 41 Two turning jackscrews, allen head, retaining ring**** (81*)
<b>POLARIZATION / WIRING:</b> 0R Reversed body polarization 0S Standard body polarization	<b>POLARIZATION / WIRING:</b> 0R Reversed body polarization 0S Standard body polarization
<b>OPTIONS</b>	
94P Mil-Spec footprint (size 100 only) Standard body polarization 0B7 Threaded inserts, standard body polarization 0BJ Mil-Spec footprint (size 100 only) with threaded inserts, standard body polarization	900 Interfacial sealing gasket 0B7 Threaded inserts and interfacial sealing gasket, standard body polarization

\* = Use numbers in parenthesis when ordering size 100.  
 \*\*\* = 69 position connectors are available in metal only.  
 \*\*\*\* = Connector body has no mounting holes.  
 = Option not RoHS compliant



# Right Angle Boardmount Low Profile (Narrow Footprint)

.050"  
9 thru 51 Contacts

**MS, MR**

MS-253-037-325-220S (PLUG)

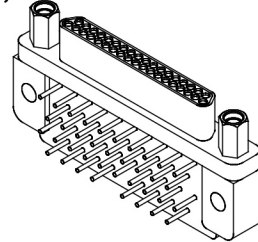

MS-263-037-435-220S (RCPT)

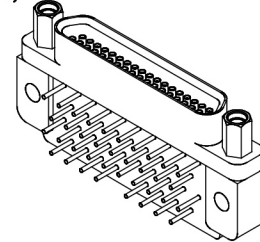

MATING MATRIX	
CONNECTOR	MATES WITH
MS-25...	MP, MQ, MR, MS receptacles
MR-25...	MP, MQ, MR, MS receptacles
MS-26...	MP, MQ, MR, MS plugs
MR-26...	MP, MQ, MR, MS plugs

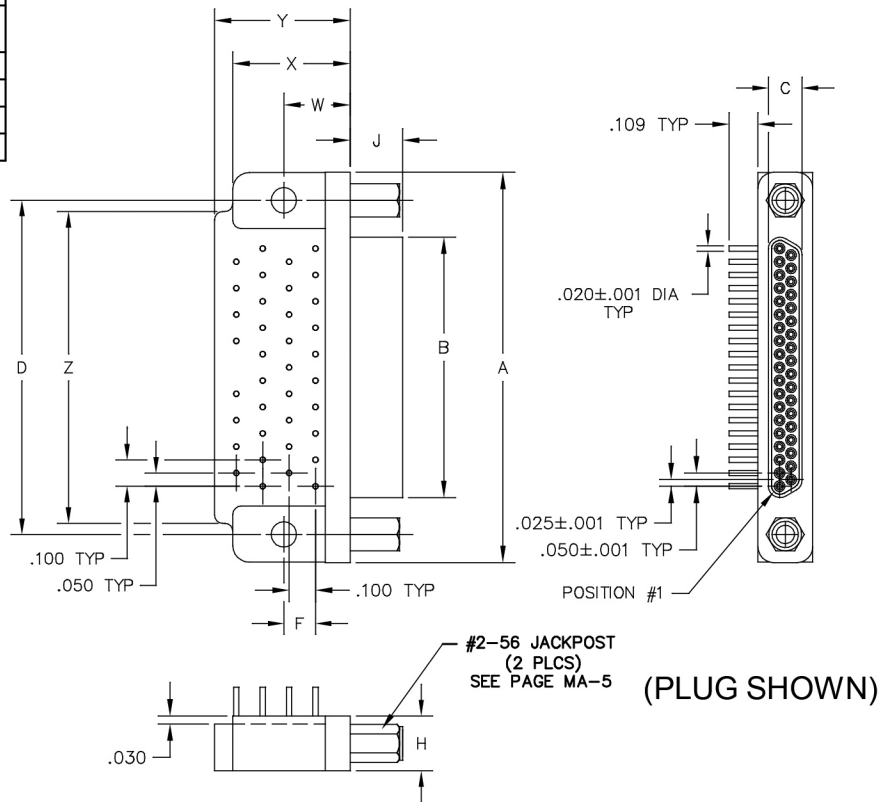

SIZE	CONTACT ROWS	DIMENSIONS														HARDWARE	MOUNTING HOLE											
		A	B		C		D	F	H	J		W	X MAX	Y MAX	Z													
			PLUG MAX	RCPT MAX	PLUG MAX	RCPT MAX				PLUG	RCPT																	
9	2	.778	.292	.378	.134	.218	.565	.020	.120	.208	.199	.180	.250	.420	.420	.775	#2-56 UNC THD	.096 DIA OR #2-56 UNC THREADED INSERT										
15		.928	.442	.528			.715																				.925	
21		1.078	.592	.678			.865																					1.075
25		1.178	.692	.778			.965																					1.175
31		1.328	.842	.928			1.115																					1.080
37		1.478	.992	1.078			1.265																					1.180
51	3	1.428	.942	1.028	.177	.260	1.215	.150	.250				.300	.425	.650	1.220												



**PLUG:** MS-253-037-325-220S  
**RECEPTACLE:** MS-263-037-435-220S  
XX-XXX-XXX-XXX-XXXX-XXX  
 |        |        |        |  
 BODY    CONTACTS    OPTIONS  
 SERIES    SIZE        HARDWARE

**PLUG**

**SERIES**

MS .050" Low Profile Metal PC Board Mount Connector  
 MR .050" Low Profile Plastic PC Board Mount Connector  
 (MS & MR mate with MP, MQ, MR, MS, receptacles)

**BODY**

- 2 2-Row (Sizes 9 thru 37)
- 3 3-Row (Size 51)
  
- BODY STYLE:**
- 5 Plug, right angle, narrow footprint, w/ mounting holes
  
- BODY MATERIAL:**
- 1 Polyphenylene Sulfide (MR only)
- 2 Electroless nickel shell w/ PPS insulator
- 3 Electrodeposited cadmium shell w/ PPS insulator
- 4 Hard anodized black shell w/ PPS insulator

**SIZE**

XXX 009, 015, 021, 025, 031, 037, 051

**CONTACTS**

- TYPE CONTACTS/TERMINATIONS:**
- 32 Pin, right angle, PCB leads, .109"
  - 33 Pin, right angle, PCB leads, .140"
  - 34 Pin, right angle, PCB leads, .172"
- PLATING OPTIONS:**
- 3 50 μ" Au contacts: Au terminations
  - 5 50 μ" Au contacts; Sn/Pb alloy terminations
  - 7 50 μ" Au contacts; SAC305 terminations

**HARDWARE**

- STYLE OF HARDWARE:**
- 00 None
  - 22 Two fixed jacknuts
  - 41 Two turning jackscrews, allen head, retaining ring\*
  - 99 Keying hardware, see options below (Body material 2, 3 and 4 only)
- POLARIZATION / WIRING:**
- 0R Reversed body polarization
  - 0S Standard body polarization

**OPTIONS**

- KPXX Two fixed jacknuts
- 905 Threaded inserts, standard body polarization

**NOTES**

See page MA-6 for keying options  
 \* = Connector body has no mounting holes.  
 = Option not RoHS compliant

**RECEPTACLE**

**SERIES**

MS .050" Low Profile Metal PC Board Mount Connector  
 MR .050" Low Profile Plastic PC Board Mount Connector  
 (MS & MR mate with MP, MQ, MR, MS plugs)

**BODY**

- 2 2-Row (Sizes 9 thru 37)
- 3 3-Row (Size 51)
  
- BODY STYLE:**
- 6 Receptacle, right angle, narrow footprint, w/ mounting holes
  
- BODY MATERIAL:**
- 1 Polyphenylene Sulfide (MR only)
- 2 Electroless nickel shell w/ PPS insulator
- 3 Electrodeposited cadmium shell w/ PPS insulator
- 4 Hard anodized black shell w/ PPS insulator

**SIZE**

XXX 009, 015, 021, 025, 031, 037, 051

**CONTACTS**

- TYPE CONTACTS/TERMINATIONS:**
- 43 Socket, right angle, PCB leads, .109"
  - 44 Socket, right angle, PCB leads, .140"
  - 45 Socket, right angle, PCB leads, .172"
- PLATING OPTIONS:**
- 3 50 μ" Au contacts: Au terminations
  - 5 50 μ" Au contacts; Sn/Pb alloy terminations
  - 7 50 μ" Au contacts; SAC305 terminations

**HARDWARE**

- STYLE OF HARDWARE:**
- 00 None
  - 22 Two fixed jacknuts
  - 41 Two turning jackscrews, allen head, retaining ring\*
  - 99 Keying hardware, see options below (Body material 2, 3 and 4 only)
- POLARIZATION / WIRING:**
- 0R Reversed body polarization
  - 0S Standard body polarization

**OPTIONS**

- KPXX Two fixed jacknuts
- 905 Threaded inserts, standard body polarization

**NOTES**

See page MA-6 for keying options  
 \* = Connector body has no mounting holes.  
 = Option not RoHS compliant



# Right Angle Boardmount Low Profile (Blind Clearance Cut)

.050"  
9 thru 51 Contacts

**MS**

MATING MATRIX	
CONNECTOR	MATES WITH
MS-2T...	MP, MQ, MR, MS receptacles
MS-2V..	MP, MQ, MR, MS plugs

MS-2T3-037-325-220S  
(PLUG)

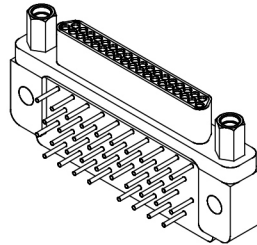

MS-2V3-037-435-220S  
(RCPT)

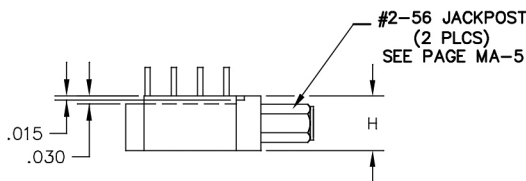
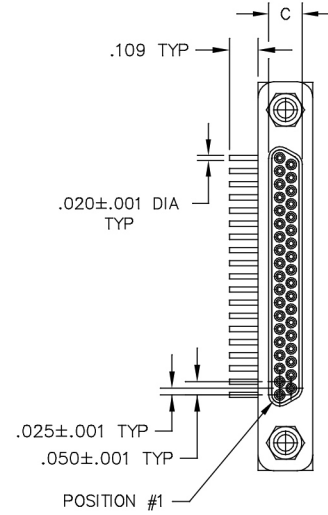
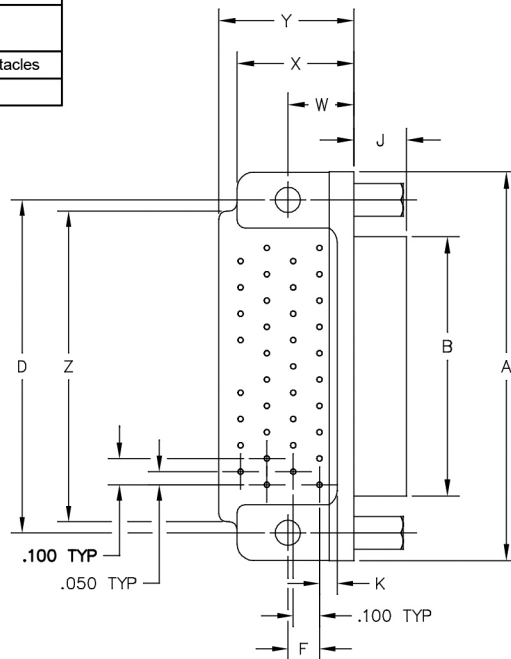
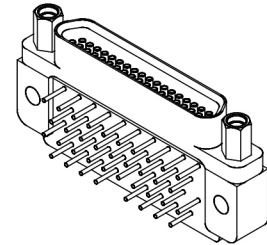

DIMENSIONS																		
SIZE	CONTACT ROWS	A	B		C		D	F	H	J		K	W	X MAX	Y MAX	Z	HARDWARE	MOUNTING HOLE
			PLUG MAX	RCPT MAX	PLUG MAX	RCPT MAX				PLUG	RCPT							
9	2	.778	.292	.378	.134	.218	.565	.020	.208	.199	.180	.067	.250	.420	.420	.775	#2-56 UNC THD	.096 DIA OR #2-56 UNC THREADED INSERT
15		.928	.442	.528			.715	.120										
21		1.078	.592	.678			.865											
25		1.178	.692	.778			.965											
31		1.328	.842	.928			1.115											
37		1.478	.992	1.078			1.265											
51	3	1.428	.942	1.028	.177	.260	1.215	.150	.250	.087	.300	.425	.650	1.220				



**PLUG:** MS-2T3-037-325-220S  
**RECEPTACLE:** MS-2V3-037-435-220S  
XX-XXX-XXX-XXX-XXXX-XXX  
 |        |        |        |  
 BODY    CONTACTS    OPTIONS  
 SERIES    SIZE        HARDWARE

**PLUG**

**SERIES**

MS .050" Low Profile Metal PC Board Mount Connector (MS mates with MP, MQ, MR, MS, receptacles)

**BODY**

- 2 2-Row (Sizes 9 thru 37)
- 3 3-Row (Size 51)

**BODY STYLE:**  
T Plug, right angle, narrow footprint, w/ mounting holes

**BODY MATERIAL:**  
 2 Electroless nickel shell w/ PPS insulator  
 3 Electrodeposited cadmium shell w/ PPS insulator   
 4 Hard anodized black shell w/ PPS insulator

**SIZE**

XXX 009, 015, 021, 025, 031, 037, 051

**CONTACTS**

**TYPE CONTACTS/TERMINATIONS:**  
 32 Pin, right angle, PCB leads, .109"  
 33 Pin, right angle, PCB leads, .140"  
 34 Pin, right angle, PCB leads, .172"

**PLATING OPTIONS:**  
 3 50 μ" Au contacts; Au terminations  
 5 50 μ" Au contacts; Sn/Pb alloy terminations   
 7 50 μ" Au contacts; SAC305 terminations

**HARDWARE**

**STYLE OF HARDWARE:**  
 00 None  
 22 Two fixed jacknuts  
 41 Two turning jackscrews, allen head, retaining ring\*  
 99 Keying hardware, see options below

**POLARIZATION / WIRING:**  
 0R Reversed body polarization  
 0S Standard body polarization

**OPTIONS**

KPXX Two fixed jacknuts  
 905 Threaded inserts, standard body polarization

**NOTES**

See page MA-6 for keying options  
 \* = Connector body has no mounting holes.  
 = Option not RoHS compliant

**RECEPTACLE**

**SERIES**

MS .050" Low Profile Metal PC Board Mount Connector (MS mates with MP, MQ, MR, MS plugs)

**BODY**

- 2 2-Row (Sizes 9 thru 37)
- 3 3-Row (Size 51)

**BODY STYLE:**  
V Receptacle, right angle, narrow footprint, w/ mounting holes

**BODY MATERIAL:**  
 2 Electroless nickel shell w/ PPS insulator  
 3 Electrodeposited cadmium shell w/ PPS insulator   
 4 Hard anodized black shell w/ PPS insulator

**SIZE**

XXX 009, 015, 021, 025, 031, 037, 051

**CONTACTS**

**TYPE CONTACTS/TERMINATIONS:**  
 43 Socket, right angle, PCB leads, .109"  
 44 Socket, right angle, PCB leads, .140"  
 45 Socket, right angle, PCB leads, .172"

**PLATING OPTIONS:**  
 3 50 μ" Au contacts; Au terminations  
 5 50 μ" Au contacts; Sn/Pb alloy terminations   
 7 50 μ" Au contacts; SAC305 terminations

**HARDWARE**

**STYLE OF HARDWARE:**  
 00 None  
 22 Two fixed jacknuts  
 41 Two turning jackscrews, allen head, retaining ring\*  
 99 Keying hardware, see options below

**POLARIZATION / WIRING:**  
 0R Reversed body polarization  
 0S Standard body polarization

**OPTIONS**

KPXX Two fixed jacknuts  
 905 Threaded inserts, standard body polarization

**NOTES**

See page MA-6 for keying options  
 \* = Connector body has no mounting holes.  
 = Option not RoHS compliant



# Board (Narrow Footprint) to Flex Cable

.050"  
9 thru 51 Contacts  
Low Profile Board Mount

**MS, MR**

Flex Cable

**MS, MR**

MS-253-037-335-410S  
(METAL)

MR-251-037-335-410S  
(PLASTIC)

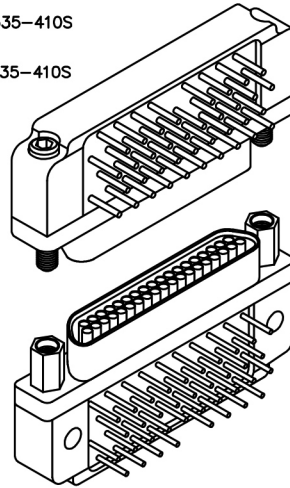

MS-263-037-445-220S  
(METAL)

MR-261-037-445-220S  
(PLASTIC)

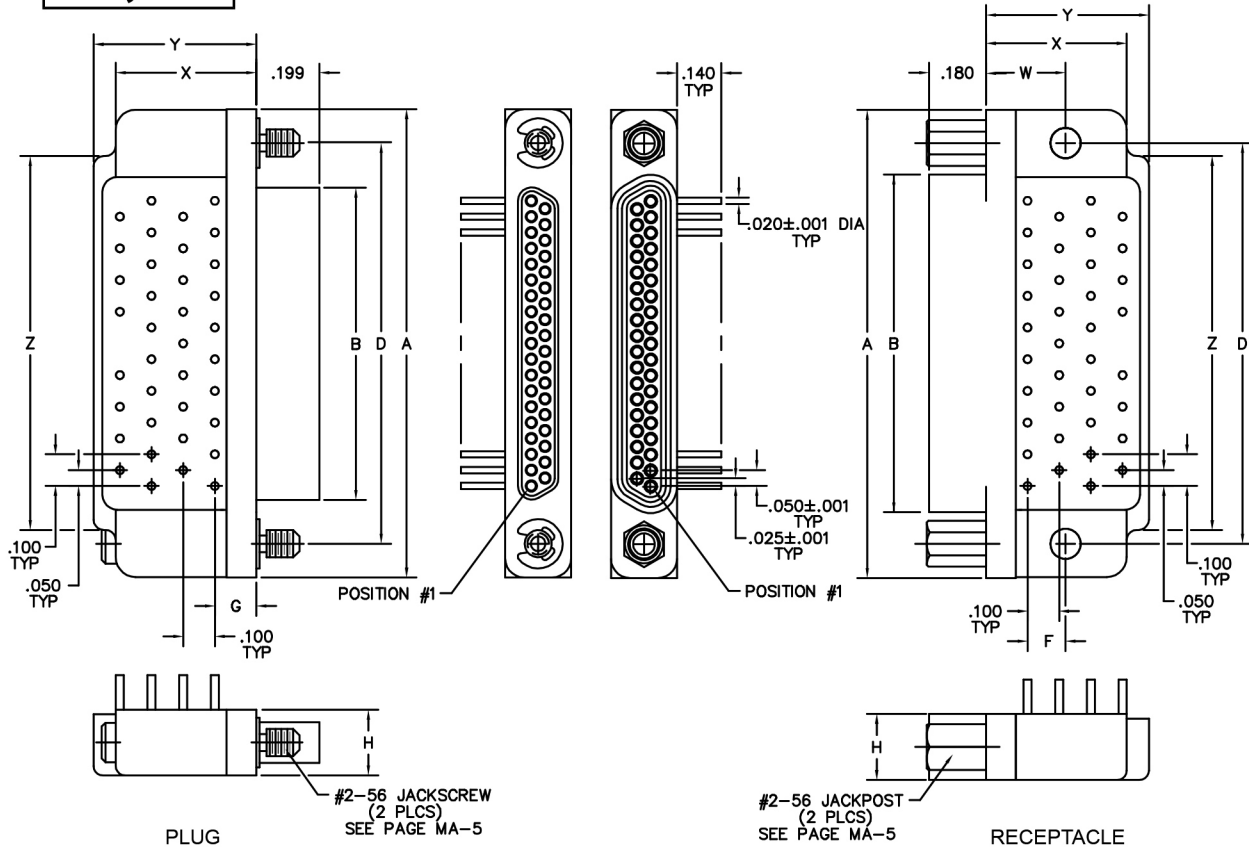

SIZE	CONTACT ROWS	A	B		D	F	G	H	W	X MAX	Y MAX	Z	HARDWARE	MOUNTING HOLE
			PLUG MAX	RCPT MAX										
9	2	.778	.292	.378	.565	.020	.230	.208	.250	.420	.420	.775	#2-56 UNC THD	.096 DIA THRU
15		.928	.442	.528	.715	.925								
21		1.078	.592	.678	.865	1.075								
25		1.178	.692	.778	.965	1.175								
31		1.328	.842	.928	1.115	1.080								
37		1.478	.992	1.078	1.265	1.180								
51	3	1.428	.942	1.028	1.215	.150	.150	.250	.300	.425	.650	1.220		



**PLUG:** MS-253-037-335-410S  
**RECEPTACLE:** MS-263-037-445-220S  
**PLUG:** MR-251-037-335-410S  
**RECEPTACLE:** MR-261-037-445-220S  
 XX-XXX-XXX-XXX-XXXX

PLUG		RECEPTACLE	
<b>SERIES</b>			
MS .050" Low Profile Metal PC Board Mount Connector	MS .050" Low Profile Metal PC Board Mount Connector	MR .050" Low Profile Plastic PC Board Mount Connector	MR .050" Low Profile Plastic PC Board Mount Connector
(MS & MR mate with MP, MQ, MR, MS receptacles)		(MS & MR mate with MP, MQ, MR, MS plugs)	
<b>BODY</b>			
2 2-Row (Sizes 9 thru 37)	2 2-Row (Sizes 9 thru 37)	3 3-Row (Size 51)	3 3-Row (Size 51)
<b>BODY STYLE:</b>		<b>BODY STYLE:</b>	
5 Plug, right angle, narrow footprint, w/ mtg holes	6 Receptacle, right angle, narrow footprint, w/ mtg holes		
<b>BODY MATERIAL:</b>		<b>BODY MATERIAL:</b>	
1 Polyphenylene Sulfide (ML only)	1 Polyphenylene Sulfide (ML only)	2 Electroless nickel shell w/ PPS insulator	2 Electroless nickel shell w/ PPS insulator
3 Electrodeposited cadmium shell w/ PPS insulator <input checked="" type="checkbox"/>	3 Electrodeposited cadmium shell w/ PPS insulator <input checked="" type="checkbox"/>	4 Hard anodized black shell w/ PPS insulator	4 Hard anodized black shell w/ PPS insulator
<b>SIZE</b>			
XXX 009, 015, 021, 025, 031, 037, 051		XXX 009, 015, 021, 025, 031, 037, 051	
<b>CONTACTS</b>			
<b>TYPE CONTACTS/TERMINATIONS:</b>		<b>TYPE CONTACTS/TERMINATIONS:</b>	
32 Pin, right angle, PCB leads, .109"	43 Socket, right angle, PCB leads, .109"	33 Pin, right angle, PCB leads, .140"	44 Socket, right angle, PCB leads, .140"
34 Pin, right angle, PCB leads, .172"	45 Socket, right angle, PCB leads, .172"		
<b>PLATING OPTIONS:</b>		<b>PLATING OPTIONS:</b>	
3 50 μ" Au contacts: Au terminations	3 50 μ" Au contacts: Au terminations	5 50 μ" Au contacts: Sn/Pb alloy terminations <input checked="" type="checkbox"/>	5 50 μ" Au contacts: Sn/Pb alloy terminations <input checked="" type="checkbox"/>
7 50 μ" Au contacts: SAC305 terminations	7 50 μ" Au contacts: SAC305 terminations		
<b>HARDWARE</b>			
<b>STYLE OF HARDWARE:</b>		<b>STYLE OF HARDWARE:</b>	
00 None	00 None	22 Two fixed jacknut assemblies	22 Two fixed jacknut assemblies
41 Two turning jackscrews, allen head, retaining ring	41 Two turning jackscrews, allen head, retaining ring		
<b>POLARIZATION / WIRING:</b>		<b>POLARIZATION / WIRING:</b>	
0R Reversed body polarization	0R Reversed body polarization	0S Standard body polarization	0S Standard body polarization

= Option not RoHS compliant



# Recommended PC Board Layout

## Right Angle, Narrow Footprint Standard Polarization

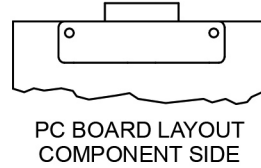
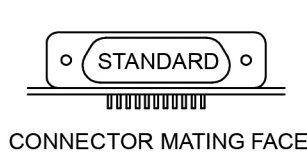

PLUG  
PC BOARD LAYOUT  
COMPONENT SIDE

RECEPTACLE  
PC BOARD LAYOUT  
COMPONENT SIDE

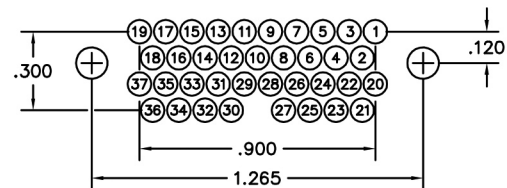
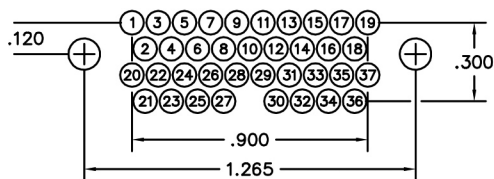
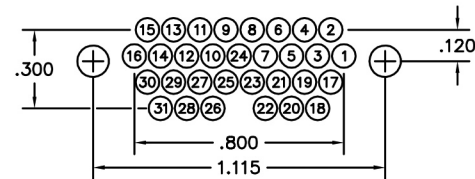
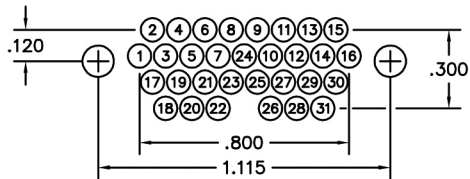
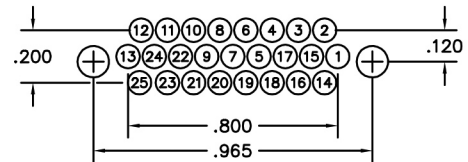
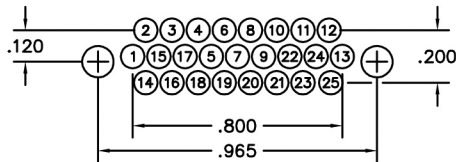
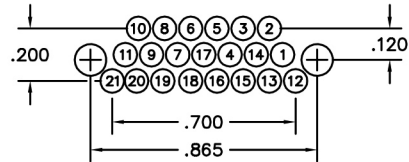
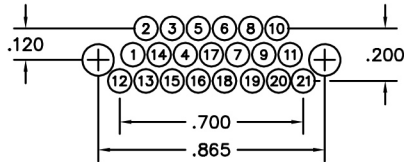
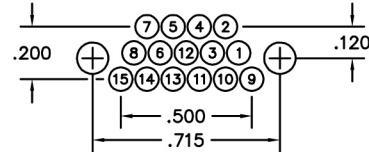
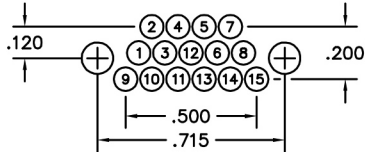
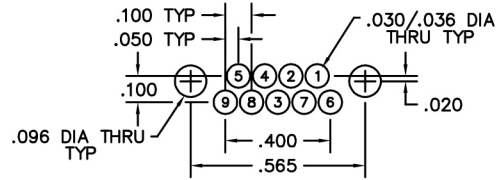
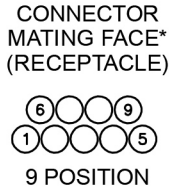
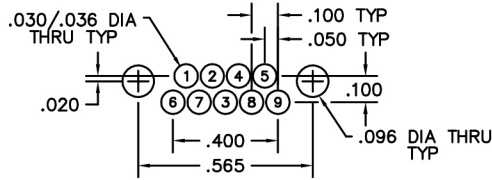

## Recommended PC Board Layout

### Right Angle, Narrow Footprint Standard Polarization

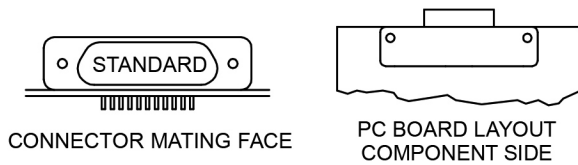

PLUG  
PC BOARD LAYOUT  
COMPONENT SIDE

RECEPTACLE  
PC BOARD LAYOUT  
COMPONENT SIDE

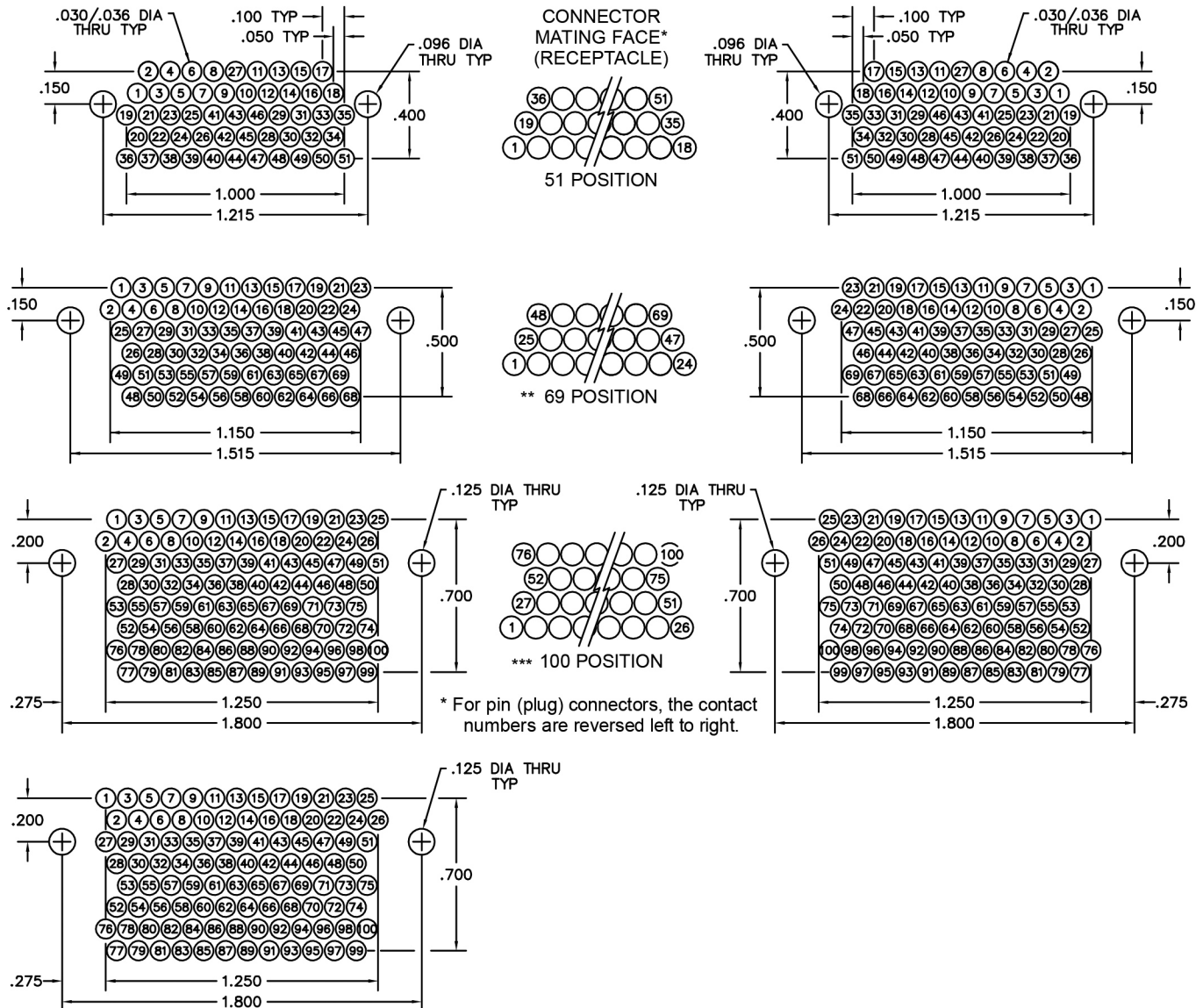

**Mil-Spec Footprint**

For Mil-Spec footprint, use "Option" -94P

\*\* = 69 and 100 positions not available in low profile (MS, MR)  
\*\*\* = 100 position not available in thru-cut body style (R, S)



# Recommended PC Board Layout

## Right Angle, Narrow Footprint Reverse Polarization



CONNECTOR MATING FACE

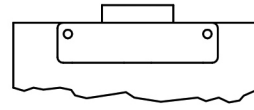

PC BOARD LAYOUT COMPONENT SIDE

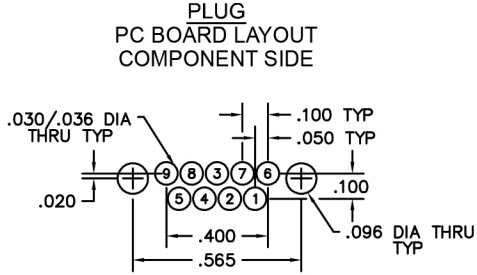

CONNECTOR MATING FACE\* (RECEPTACLE)

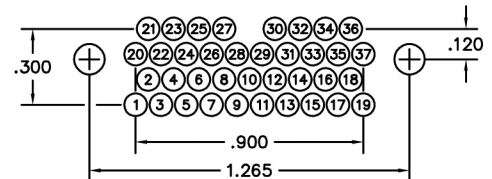
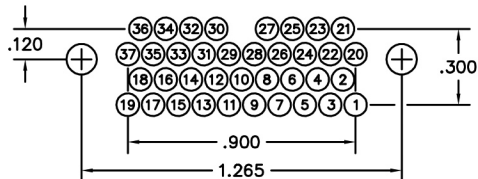
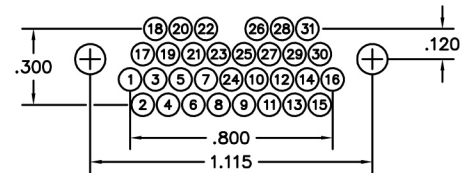
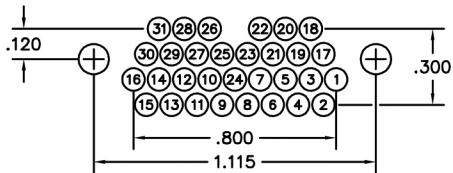
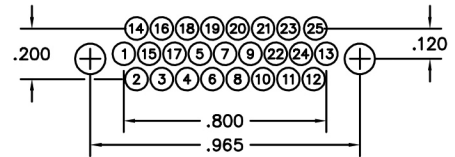
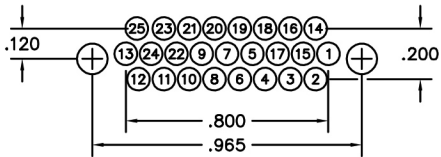
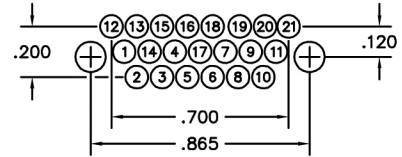
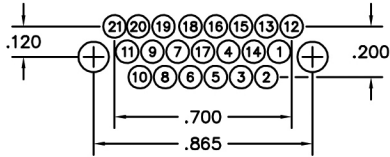
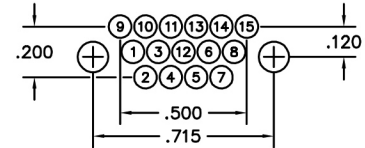
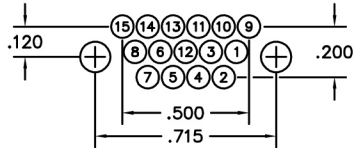
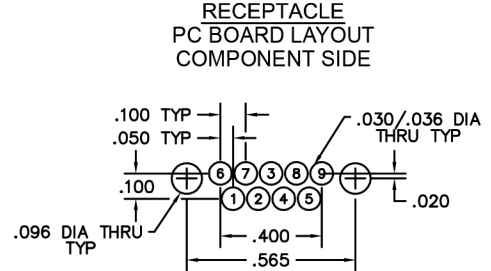

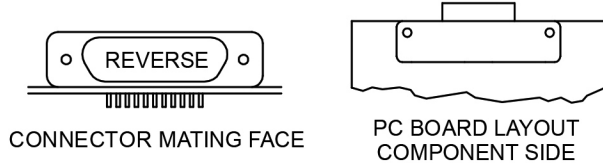

## Recommended PC Board Layout

Right Angle, Narrow Footprint  
Reverse Polarization

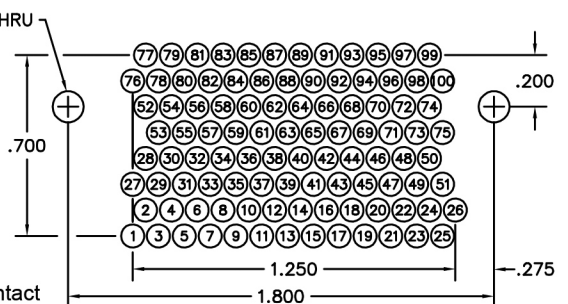
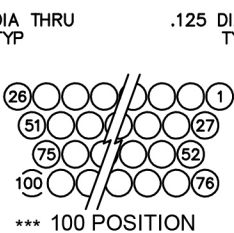
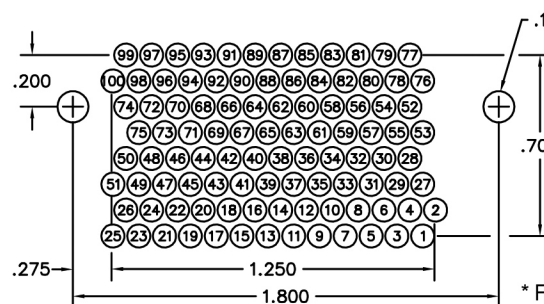
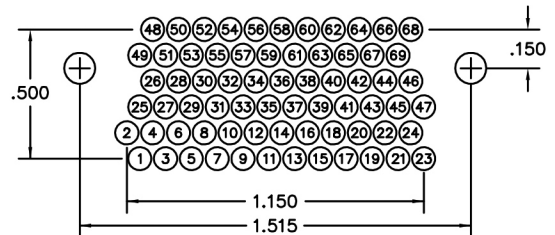
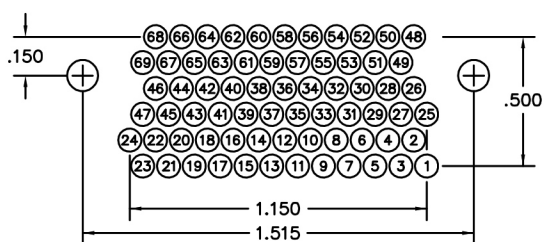
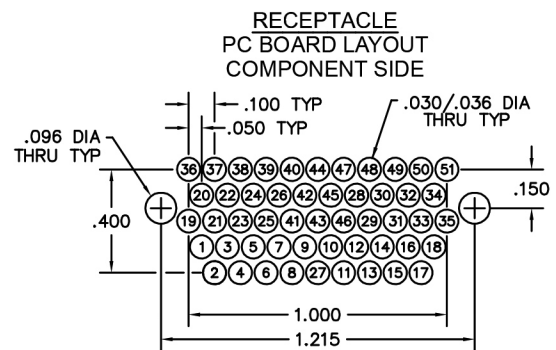
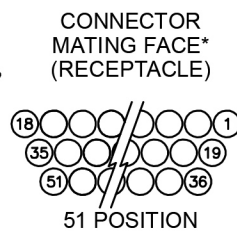
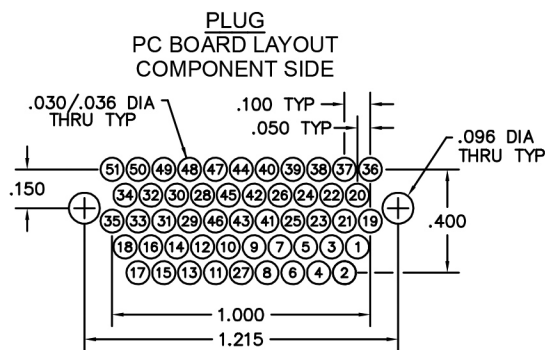

\* For pin (plug) connectors, the contact numbers are reversed left to right.

\*\* = 69 and 100 positions not available in low profile (MS, MR)  
\*\*\* = 100 position not available in thru-cut body style (R, S)



# Right Angle Boardmount (Compressed Footprint)

**.050"**  
**9 thru 100 Contacts**

**MK**

MK-2P2-031-A35-220S  
(PLUG)

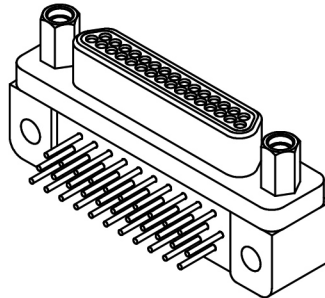

MK-2Q2-031-B45-220S  
(RECEPTACLE)

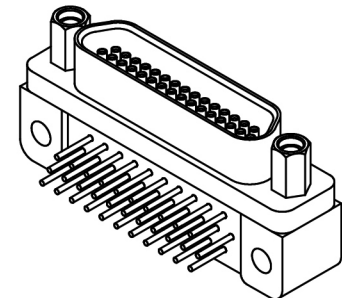

MATING MATRIX	
CONNECTOR	MATES WITH
MK-2P...	MK, ML, MM, MN receptacles
MK-2Q...	MK, ML, MM, MN plugs

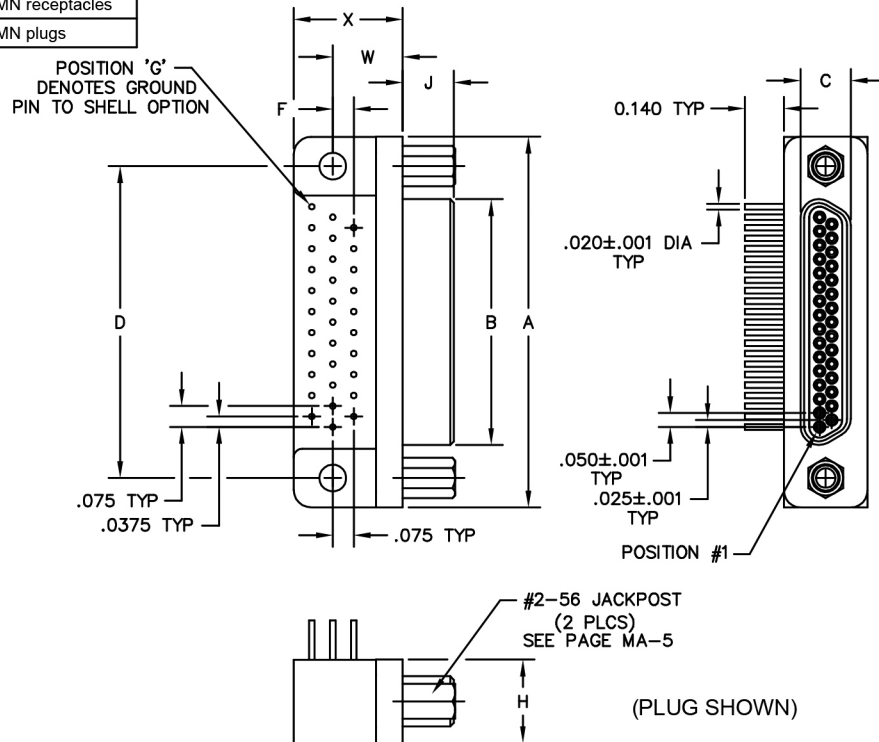

SIZE	CONTACT ROWS	DIMENSIONS													
		A	B		C		D	F	H	J		W	X MAX	HARDWARE	MOUNTING HOLE
			PLUG MAX	RCPT MAX	PLUG MAX	RCPT MAX				PLUG	RCPT				
9	2	.775	.334	.400	.185	.251	.565	.0375	.298	.183	.195	.250	.400	#2-56 UNC THD	.096 DIA OR #2-56 UNC THREADED INSERT
15		.925	.484	.550			.715								
21		1.075	.634	.700			.865								
25		1.175	.734	.800			.965								
31		1.325	.884	.950			1.115								
37		1.475	1.034	1.100			1.265								
51	3	1.425	.984	1.050	.228	.294	1.215	.1125	.341	.300	.490	.400	.660	#4-40 UNC THD	.125 DIA OR #4-40 UNC THREADED INSERT
69		1.725	1.284	1.350			1.515								
100	4	2.160	1.384	1.508	.271	.394	1.800	.1875	.384						



**PLUG:** MK-2P2-031-335-220S  
**RECEPTACLE:** MK-2Q2-031-445-220S  
 XX-XXX-XXX-XXX-XXXX-XXX  
 |       |       |       |  
 BODY   CONTACTS   OPTIONS  
 SERIES   SIZE        HARDWARE

**PLUG**

**SERIES**

MK .050" Rugged Metal PC Board Mount Connector

**BODY**

- 2 2-Row (Sizes 9 thru 37)
- 3 3-Row (Size 51 & 69)
- 4 4-Row (Size 100)

**BODY STYLE:**  
 P Plug, right angle, compressed footprint

**BODY MATERIAL:**  
 2 Electroless nickel shell w/ PPS insulator  
 3 Electrodeposited cadmium shell w/ PPS insulator   
 4 Hard anodized black shell w/ PPS insulator  
 5 Stainless steel shell w/ PPS insulator  
 A Pure Electro-Deposited Aluminum  
 K Zinc Nickel Plating  
 T Nickel Polymer Plating

**SIZE**

XXX 009, 015, 021, 025, 031, 037, 051, 069, 100

**CONTACTS**

**TYPE CONTACTS/TERMINATIONS:**  
 32 Pin, right angle, PCB leads, .109"  
 33 Pin, right angle, PCB leads, .140"  
 34 Pin, right angle, PCB leads, .172"  
 A2 Pin, right angle, PCB leads, .109", w/ ground pin option  
 A3 Pin, right angle, PCB leads, .140", w/ ground pin option  
 A4 Pin, right angle, PCB leads, .172", w/ ground pin option

**PLATING OPTIONS:**  
 3 50 μ" Au contacts: Au terminations  
 5 50 μ" Au contacts: Sn/Pb alloy terminations   
 7 50 μ" Au contacts: SAC305 terminations

**HARDWARE**

**STYLE OF HARDWARE:**  
 00 None  
 22 Two fixed jacknuts (62\*)  
 99 Keying hardware, see options below

**POLARIZATION:**  
 0S Standard body polarization

**OPTIONS**

0B7 Threaded inserts in mounting holes  
 KPXX Two fixed jacknuts (KN\*)

**NOTES**

See page MA-6 for keying options

\* = Use numbers in parenthesis when ordering size 100.  
 = Option not RoHS compliant

**RECEPTACLE**

**SERIES**

MK .050" Rugged Metal PC Board Mount Connector

**BODY**

- 2 2-Row (Sizes 9 thru 37)
- 3 3-Row (Size 51 & 69)
- 4 4-Row (Size 100)

**BODY STYLE:**  
 Q Receptacle, right angle, compressed footprint

**BODY MATERIAL:**  
 2 Electroless nickel shell w/ PPS insulator  
 3 Electrodeposited cadmium shell w/ PPS insulator   
 4 Hard anodized black shell w/ PPS insulator  
 5 Stainless steel shell w/ PPS insulator  
 A Pure Electro-Deposited Aluminum  
 K Zinc Nickel Plating  
 T Nickel Polymer Plating

**SIZE**

XXX 009, 015, 021, 025, 031, 037, 051, 069, 100

**CONTACTS**

**TYPE CONTACTS/TERMINATIONS:**  
 43 Socket, right angle, PCB leads, .109"  
 44 Socket, right angle, PCB leads, .140"  
 45 Socket, right angle, PCB leads, .172"  
 B3 Socket, right angle, PCB leads, .109", w/ ground pin option  
 B4 Socket, right angle, PCB leads, .140", w/ ground pin option  
 B5 Socket, right angle, PCB leads, .172", w/ ground pin option

**PLATING OPTIONS:**  
 3 50 μ" Au contacts: Au terminations  
 5 50 μ" Au contacts: Sn/Pb alloy terminations   
 7 50 μ" Au contacts: SAC305 terminations

**HARDWARE**

**STYLE OF HARDWARE:**  
 00 None  
 22 Two fixed jacknuts (62\*)  
 99 Keying hardware, see options below

**POLARIZATION:**  
 0S Standard body polarization

**OPTIONS**

900 Interfacial sealing gasket  
 0B7 Threaded inserts in mounting holes and interfacial sealing gasket  
 KPXX Two fixed jacknuts (KN\*) and interfacial sealing gasket

**NOTES**

See page MA-6 for keying options



# Recommended PC Board Layout

## Right Angle, Compressed Footprint

### Standard Polarization

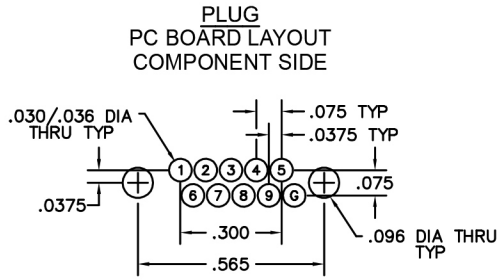
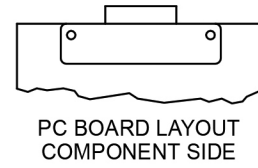
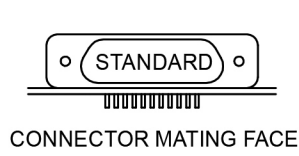

CONNECTOR MATING FACE\* (RECEPTACLE)

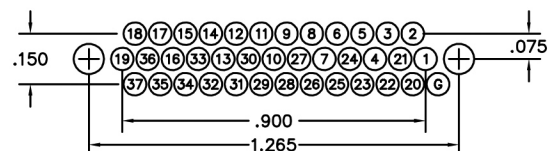
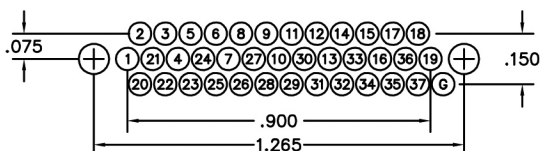
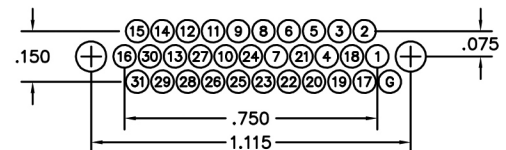
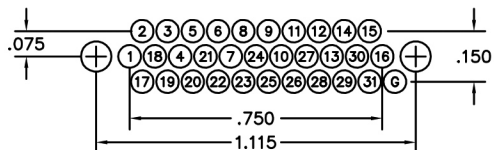
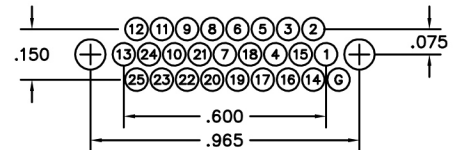
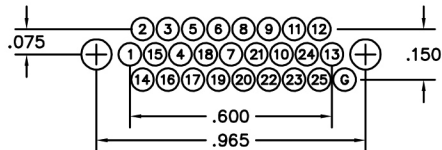
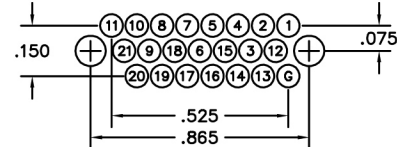
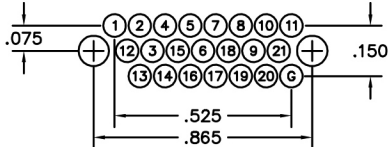
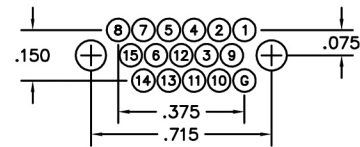
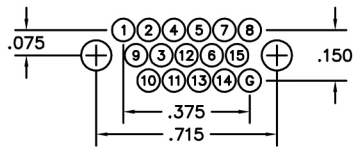
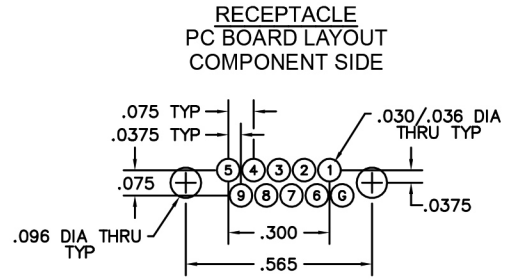
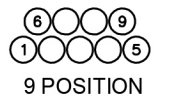

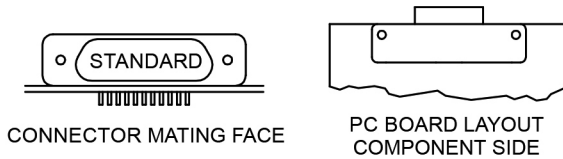

## Recommended PC Board Layout

Right Angle, Compressed Footprint  
Standard Polarization

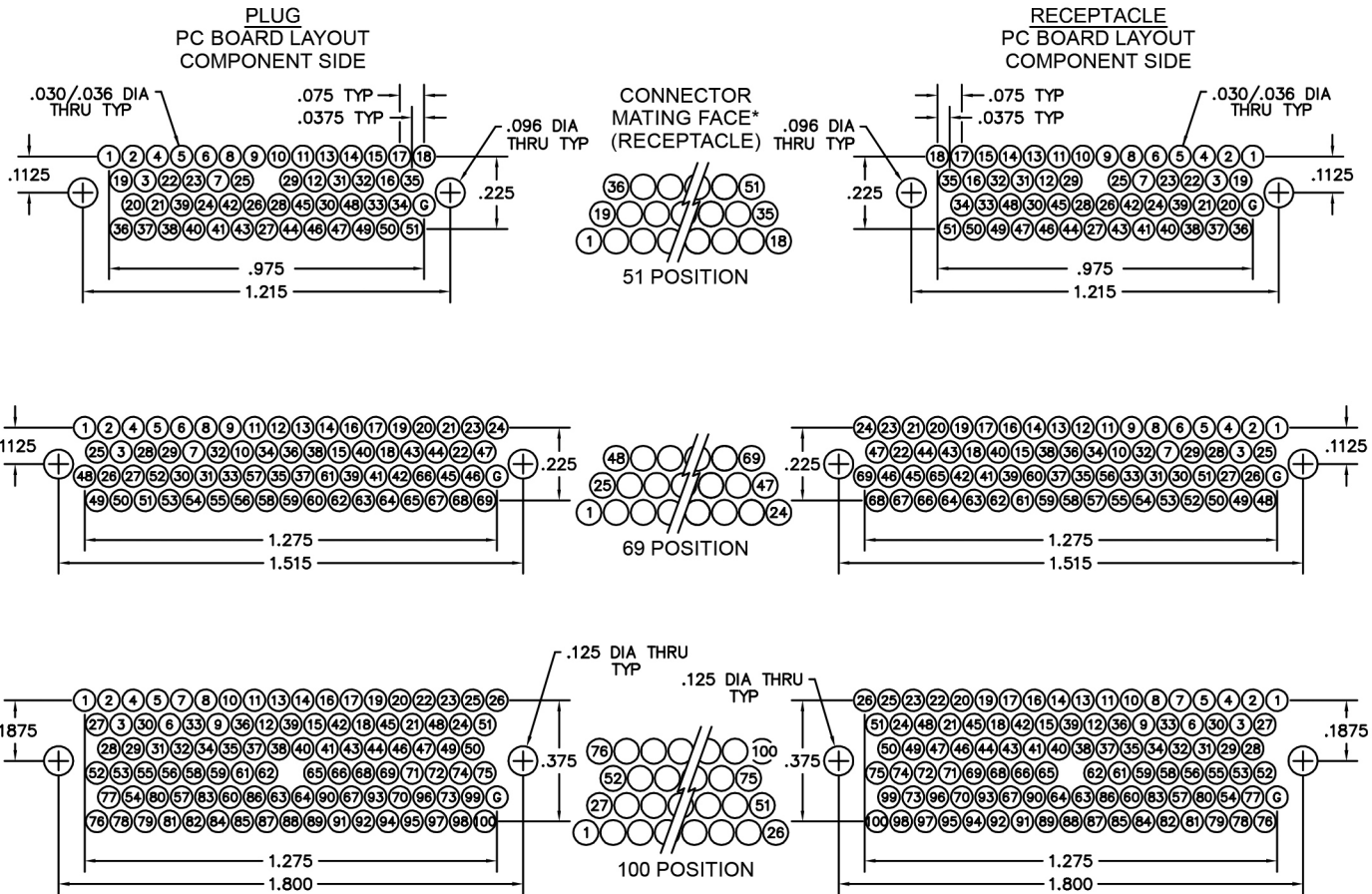

\* For pin (plug) connectors, the contact numbers are reversed left to right.



# Board (Standard Footprint) to Cable

**.050"**

**9 thru 100 Contacts**

**Rugged Board Mount**

**MK, ML**

**Rugged Cable**

**MM, MN**

MK-283-025-435-220R  
(METAL)

ML-281-025-435-220R  
(PLASTIC)

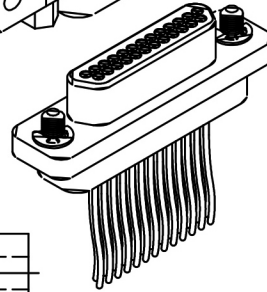
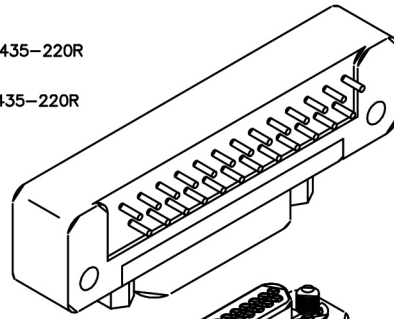

MM-213-025-161-41WQ  
(METAL)

MN-211-025-161-41WQ  
(PLASTIC)

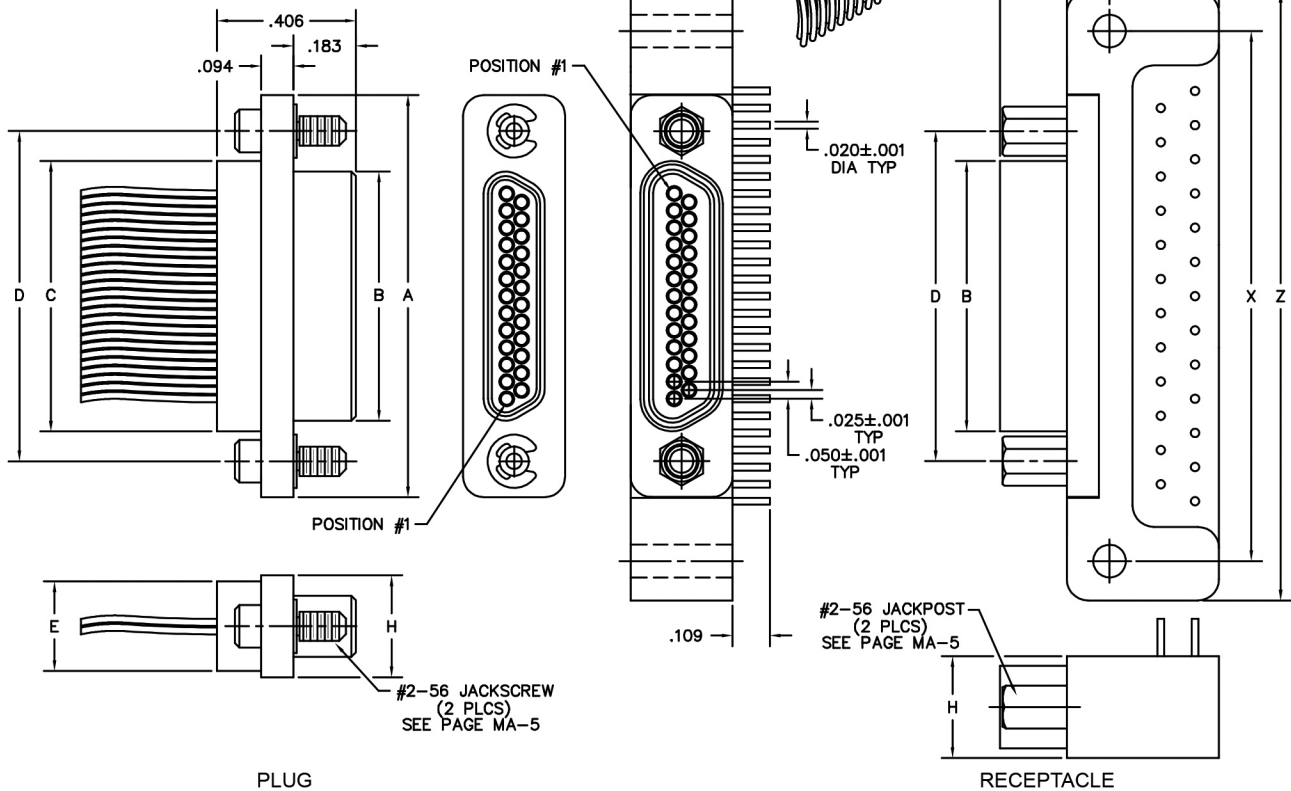

SIZE	CONTACT ROWS	DIMENSIONS											HARDWARE	MOUNTING HOLE
		A	B		C	D	E	H	X	Y	Z			
			PLUG MAX	RCPT MAX								POTTING WELL MAX		
9	2	.775	.334	.400	.390	.565	.270	.298	1.150	.455	1.390	#2-56 UNC THD	.096 DIA OR #2-56 UNC THREADED INSERT	
15		.925	.484	.550	.540	.715			1.300		1.540			
21		1.075	.634	.700	.690	.865			1.450		1.690			
25		1.175	.734	.800	.790	.965			1.550		1.790			
31		1.325	.884	.950	.940	1.115			1.800		2.040			
37	1.475	1.034	1.100	1.090	1.265	2.100	2.340							
51	3	1.425	.984	1.050	1.040	1.215	.310	.341	1.600	.565	1.875	#4-40 UNC THD	.125 DIA OR #4-40 UNC THREADED INSERT	
100	4	2.160	1.384	1.508	1.432	1.800	.360	.384	2.500	.665**	2.780			

\* = .225 FOR ".05K" AND "0BJ" SPECIAL CODES (MIL-SPEC FOOTPRINT FOR 100 POSITION ONLY)  
 \*\* = .765 MAX FOR ".05K" AND "0BJ" SPECIAL CODES (MIL-SPEC FOOTPRINT FOR 100 POSITION ONLY)



PLUG: MM-213-025-161-41WQ

RECEPTACLE: MK-283-025-435-220R

PLUG: MN-211-025-161-41WQ

RECEPTACLE: ML-281-025-435-220R

**PLUG**

**RECEPTACLE**

XX-XXX-XXX-XXX-XXXX-XXX

SERIES	
MM .050" Rugged Metal I/O Connector MN .050" Rugged Plastic I/O Connector (MM & MN mate with MK, ML, MM, MN receptacles)	MK .050" Rugged Metal PC Board Mount Connector ML .050" Rugged Plastic PC Board Mount Connector (MK & ML mate with MK, ML, MM, MN plugs)
BODY	
2 2-Row (Sizes 9 thru 37) 3 3-Row (Size 51) 4 4-Row (Size 100)	2 2-Row (Sizes 9 thru 37) 3 3-Row (Size 51) 4 4-Row (Size 100)
BODY STYLE: 1 Plug, straight, with ears	BODY STYLE: 8 Receptacle, right angle, standard footprint, w/ mtg holes
BODY MATERIAL: 1 Polyphenylene Sulfide (MN only) 2 Polyphenylene Sulfide with electroless nickel shell 3 Polyphenylene Sulfide with electrodeposited cadmium shell <input type="checkbox"/> 4 Polyphenylene Sulfide with hard anodized black shell 5 Polyphenylene Sulfide with stainless steel shell A Pure Electro-Deposited Aluminum K Zinc Nickel Plating T Nickel Polymer Plating	BODY MATERIAL: 1 Polyphenylene Sulfide (ML only) 2 Polyphenylene Sulfide with electroless nickel shell 3 Polyphenylene Sulfide with electrodeposited cadmium shell <input type="checkbox"/> 4 Polyphenylene Sulfide with hard anodized black shell 5 Polyphenylene Sulfide with stainless steel shell A Pure Electro-Deposited Aluminum K Zinc Nickel Plating T Nickel Polymer Plating
SIZE	
XXX 009, 015, 021, 025, 031, 037, 051, 100	XXX 009, 015, 021, 025, 031, 037, 051, 100
CONTACTS	
TYPE CONTACTS/TERMINATIONS: 11 Pin, straight, solder cup 14 Pin, straight, .500" pigtails (.018 dia) 15 Pin, straight, 1.000" pigtails (.018 dia) 16 Pin, straight, crimped wire	TYPE CONTACTS/TERMINATIONS: 43 Socket, right angle, PCB leads, .109" 44 Socket, right angle, PCB leads, .140" 45 Socket, right angle, PCB leads, .172"
PLATING OPTIONS: 1 50 μ" Au contacts (crimp wire) 3 50 μ" Au contacts: 10 μ" Au terminations (solder cup, pigtail) 5 50 μ" Au contacts; Sn/Pb alloy terminations (pigtail) <input type="checkbox"/> 7 50 μ" Au contacts; SAC305 terminations (pigtail)	PLATING OPTIONS: 3 50 μ" Au contacts: 10 μ" Au terminations 5 50 μ" Au contacts; Sn/Pb alloy terminations <input type="checkbox"/> 7 50 μ" Au contacts; SAC305 terminations
HARDWARE	
STYLE OF HARDWARE: 00 None 22 Two fixed jacknut assemblies (62*) 41 Two turning jackscrews, allen head, retaining ring (81*) 42 Two long turning jackscrews, allen head, retaining ring (82*) 43 Two turning jackscrews, slot head, retaining ring (83*) 44 Two long turning jackscrews, slot head, retaining ring (84*) 45 Two turning jackscrews, allen head, captivated** (85*) 99 Keying hardware, see options below (Body material 2, 3 and 4 only)	STYLE OF HARDWARE: 00 None 22 Two fixed jacknut assemblies (62*) 99 Keying hardware, see options below (Body material 2, 3 and 4 only)
POLARIZATION / WIRING: 00 None XX For wiring codes, see page MA-3 & MA-4	POLARIZATION / WIRING OR Reversed body polarization
OPTIONS	
KSXX Two turning jackscrews. See page MA-6 for keying options (KJ*)	KPXX Two fixed jacknuts and interfacial sealing gasket. See page MA-6 for keying options (KN*) 900 Interfacial sealing gasket 05K Mil-Spec footprint (size 100 only) 0B7 Threaded inserts and interfacial sealing gasket 0BJ Mil-Spec footprint (size 100 only) with threaded inserts and interfacial sealing gasket X

\* = Use numbers or letters in parenthesis when ordering size 100.

\*\* = Captive hardware is factory installed and non-removable.

= Option not RoHS compliant



# Board (Standard Footprint) to Cable

.050"

9 thru 100 Contacts

Rugged Board Mount

**MK, ML**

Rugged Cable

**MM, MN**

MK-273-025-325-220R  
(METAL)

ML-271-025-325-220R  
(PLASTIC)

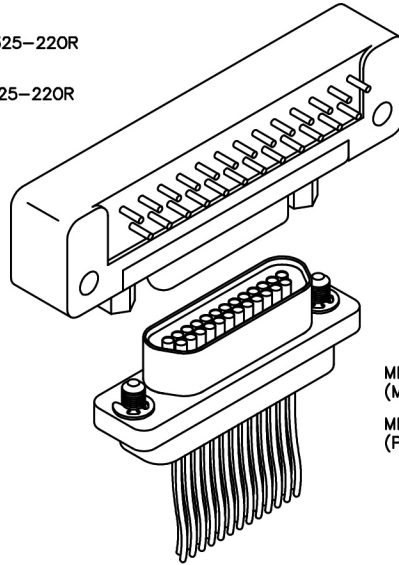

MM-223-025-261-41WQ  
(METAL)

MN-221-025-261-41WQ  
(PLASTIC)

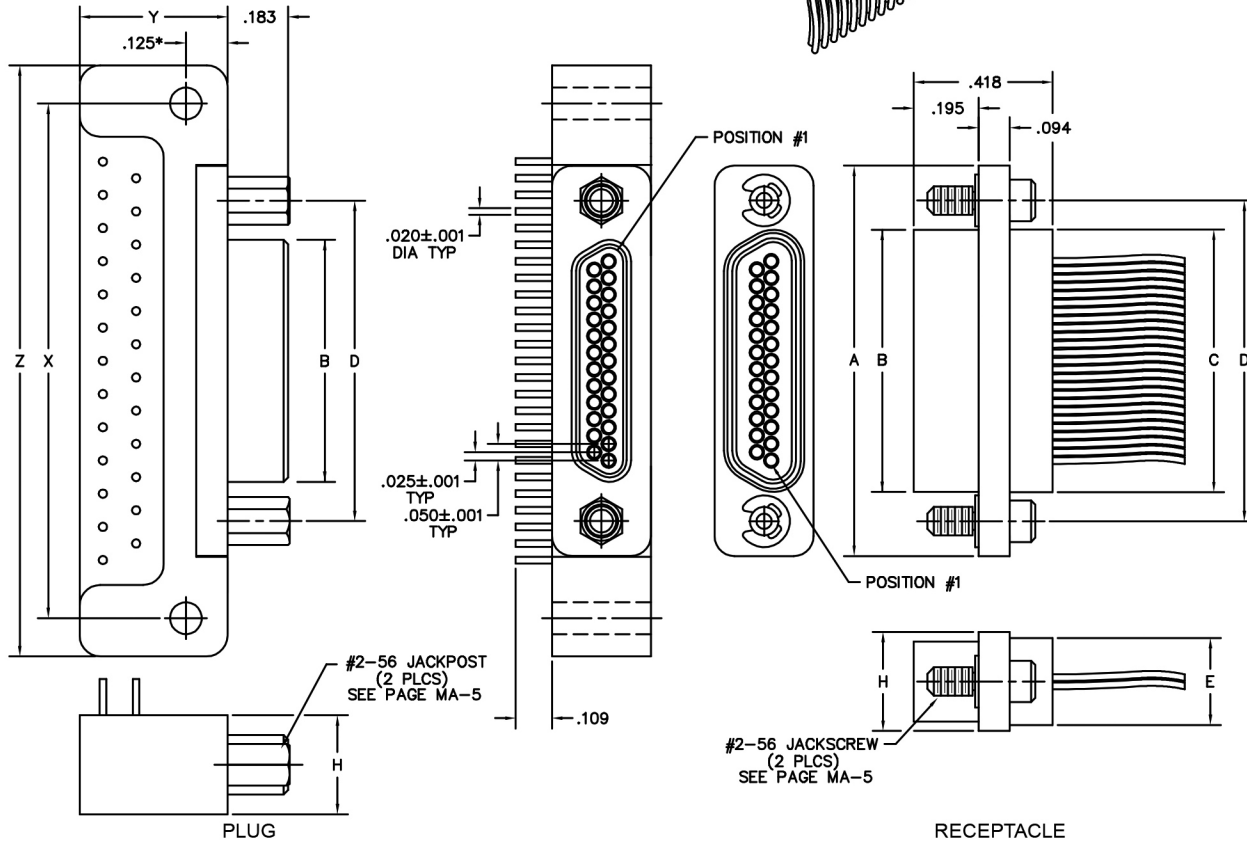

SIZE	CONTACT ROWS	DIMENSIONS										HARDWARE	MOUNTING HOLE
		A	B		C	D	E	H	X	Y	Z		
			PLUG MAX	RCPT MAX			POTTING WELL MAX			MAX	MAX		
9	2	.775	.334	.400	.390	.565	.270	.298	.455	1.390	#2-56 UNC THD	.096 DIA OR #2-56 UNC THREADED INSERT	
15		.925	.484	.550	.540	.715							1.540
21		1.075	.634	.700	.690	.865							1.690
25		1.175	.734	.800	.790	.965							1.790
31		1.325	.884	.950	.940	1.115							2.040
37		1.475	1.034	1.100	1.090	1.265	2.100	2.340					
51	3	1.425	.984	1.050	1.040	1.215	.310	.341	1.600	.565	1.875		
100	4	2.160	1.384	1.508	1.432	1.800	.360	.384	2.500	.665**	2.780	#4-40 UNC THD	.125 DIA OR #4-40 UNC THREADED INSERT

\* = .225 FOR ".05K" AND "0BJ" SPECIAL CODES (MIL-SPEC FOOTPRINT FOR 100 POSITION ONLY)  
 \*\* = .765 MAX FOR ".05K" AND "0BJ" SPECIAL CODES (MIL-SPEC FOOTPRINT FOR 100 POSITION ONLY)



**PLUG:** MK-273-025-325-220R  
**RECEPTACLE:** MM-223-025-261-41WQ  
**PLUG:** ML-271-025-325-220R  
**RECEPTACLE:** MN 221 025 261 41WQ  
 XX-XXX-XXX-XXX-XXXX-XXX

**PLUG**

**RECEPTACLE**

SERIES	
MK .050" Rugged Metal PC Board Mount Connector	MM .050" Rugged Metal I/O Connector
ML .050" Rugged Plastic PC Board Mount Connector (MK & ML mate with MK, ML, MM, MN receptacles)	MN .050" Rugged Plastic I/O Connector (MM & MN mate with MK, ML, MM, MN plugs)
BODY	
2 2-Row (Sizes 9 thru 37)	2 2-Row (Sizes 9 thru 37)
3 3-Row (Size 51)	3 3-Row (Size 51)
4 4-Row (Size 100)	4 4-Row (Size 100)
<b>BODY STYLE:</b>	<b>BODY STYLE:</b>
7 Plug, right angle, standard footprint, w/ mtg holes	2 Receptacle, straight, with ears
<b>BODY MATERIAL:</b>	<b>BODY MATERIAL:</b>
1 Polyphenylene Sulfide (ML only)	1 Polyphenylene Sulfide (MN only)
2 Polyphenylene Sulfide with electroless nickel shell	2 Polyphenylene Sulfide with electroless nickel shell
3 Polyphenylene Sulfide with electrodeposited cadmium shell <input checked="" type="checkbox"/>	3 Polyphenylene Sulfide with electrodeposited cadmium shell <input checked="" type="checkbox"/>
4 Polyphenylene Sulfide with hard anodized black shell	4 Polyphenylene Sulfide with hard anodized black shell
5 Polyphenylene Sulfide with stainless steel shell	5 Polyphenylene Sulfide with stainless steel shell
A Pure Electro-Deposited Aluminum	A Pure Electro-Deposited Aluminum
K Zinc Nickel Plating	K Zinc Nickel Plating
T Nickel Polymer Plating	T Nickel Polymer Plating
SIZE	
XXX 009, 015, 021, 025, 031, 037, 051, 100	XXX 009, 015, 021, 025, 031, 037, 051, 100
CONTACTS	
<b>TYPE CONTACTS/TERMINATIONS:</b>	<b>TYPE CONTACTS/TERMINATIONS:</b>
32 Pin, right angle, PCB leads, .109"	21 Socket, straight, solder cup
33 Pin, right angle, PCB leads, .140"	24 Socket, straight, .500" pigtails (.018 dia)
34 Pin, right angle, PCB leads, .172"	25 Socket, straight, 1.000" pigtails (.018 dia)
	26 Socket, straight, crimped wire
<b>PLATING OPTIONS:</b>	<b>PLATING OPTIONS:</b>
3 50 μ" Au contacts; 10 u" Au terminations	1 50 μ" Au contacts (crimp wire)
5 50 μ" Au contacts; Sn/Pb alloy terminations <input checked="" type="checkbox"/>	3 50 μ" Au contacts; 10 u" Au terminations (solder cup, pigtail)
7 50 μ" Au contacts; SAC305 terminations	5 50 μ" Au contacts; Sn/Pb alloy terminations (pigtail) <input checked="" type="checkbox"/>
	7 50 μ" Au contacts; SAC305 terminations (pigtail)
HARDWARE	
<b>STYLE OF HARDWARE:</b>	<b>STYLE OF HARDWARE:</b>
00 None	00 None
22 Two fixed jacknut assemblies (62*)	22 Two fixed jacknut assemblies (62*)
99 Keying hardware, see options below (Body material 2, 3 and 4 only)	41 Two turning jackscrews, allen head, retaining ring (81*)
	42 Two long turning jackscrews, allen head, retaining ring (82*)
	43 Two turning jackscrews, slot head, retaining ring (83*)
	44 Two long turning jackscrews, slot head, retaining ring (84*)
	45 Two turning jackscrews, allen head, captivated** (85*)
	99 Keying hardware, see options below (Body material 2, 3 and 4 only)
<b>POLARIZATION / WIRING:</b>	<b>POLARIZATION / WIRING</b>
0R Reversed body polarization	00 None
	XX For wiring codes, see page MA-3 & MA-4
OPTIONS	
KPXX Two fixed jacknuts. See page MA-6 for keying options (KN*)	KSXX Two turning jackscrews and interfacial sealing gasket. See page MA-6 for keying options (KJ*)
05K Mil-Spec footprint (size 100 only)	900 Interfacial sealing gasket
0B7 Threaded inserts	
0BJ Mil-Spec footprint (size 100 only) with threaded inserts	

\* = Use numbers or letters in parenthesis when ordering size 100.  
 \*\* = Captive hardware is factory installed and non-removable.  
 = Option not RoHS compliant



**Recommended PC Board Layout**  
**Right Angle, Standard Footprint**  
**Reverse Polarization**

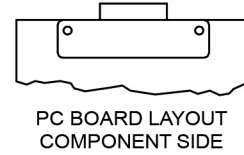
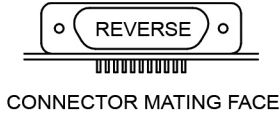

PLUG  
 PC BOARD LAYOUT  
 COMPONENT SIDE

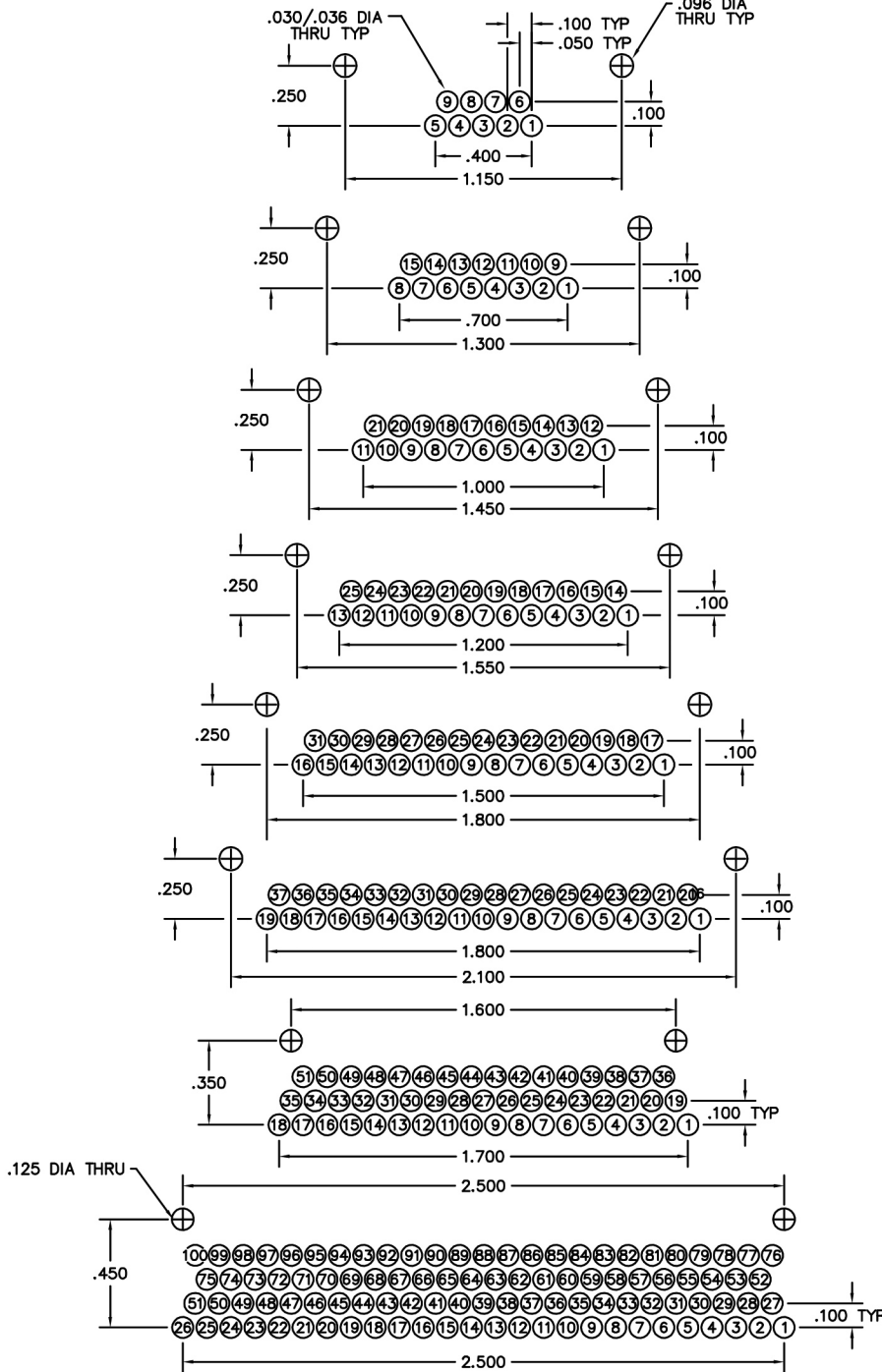

CONNECTOR MATING FACE (PLUG)

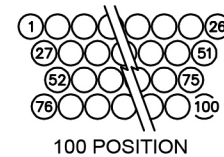
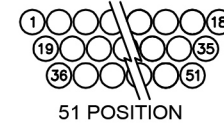

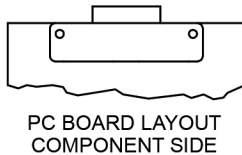
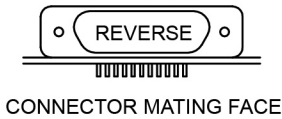

## Recommended PC Board Layout

Right Angle, Standard Footprint  
Reverse Polarization

CONNECTOR MATING FACE (RECEPTACLE)

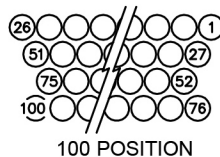
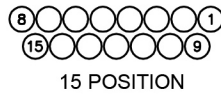

RECEPTACLE  
PC BOARD LAYOUT  
COMPONENT SIDE

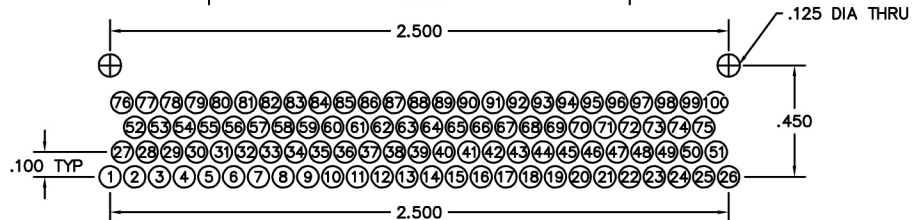
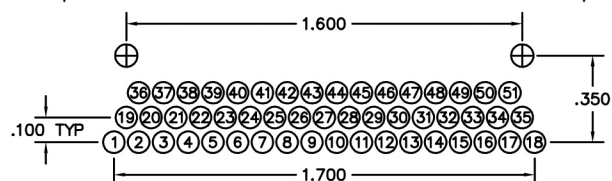
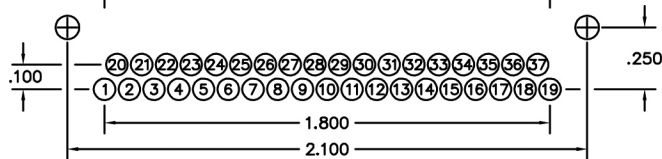
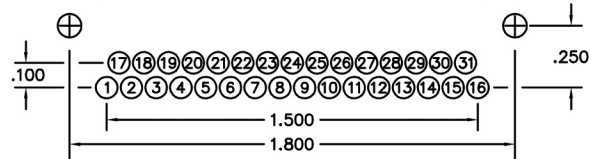
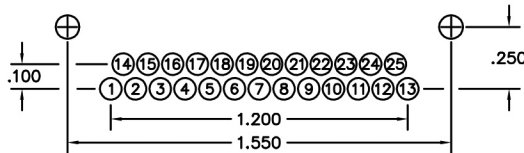
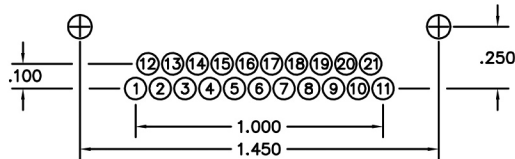
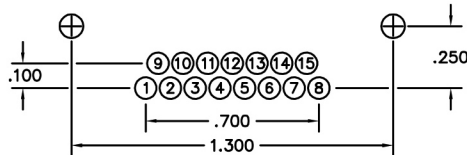
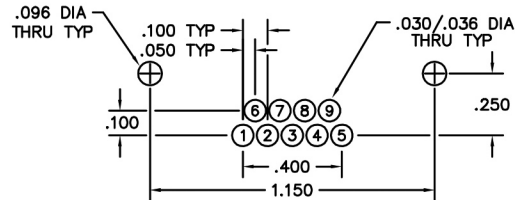



# Cable to Board (Narrow Footprint)

.050"

9 thru 100 Contacts

Rugged Cable

**MM, MN**

Rugged Board Mount

**MK, ML**

MM-312-051-153-4400  
(METAL)

MN-311-051-153-4400  
(PLASTIC)

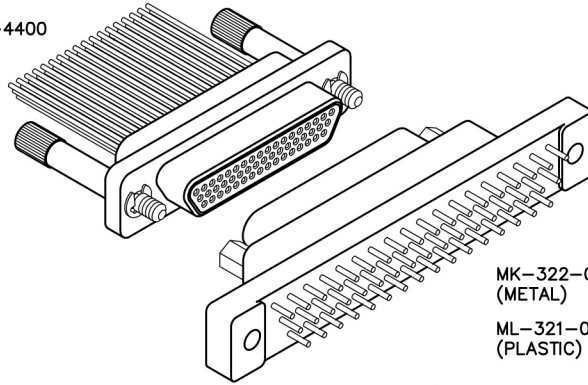

MK-322-051-235-2200  
(METAL)

ML-321-051-235-2200  
(PLASTIC)

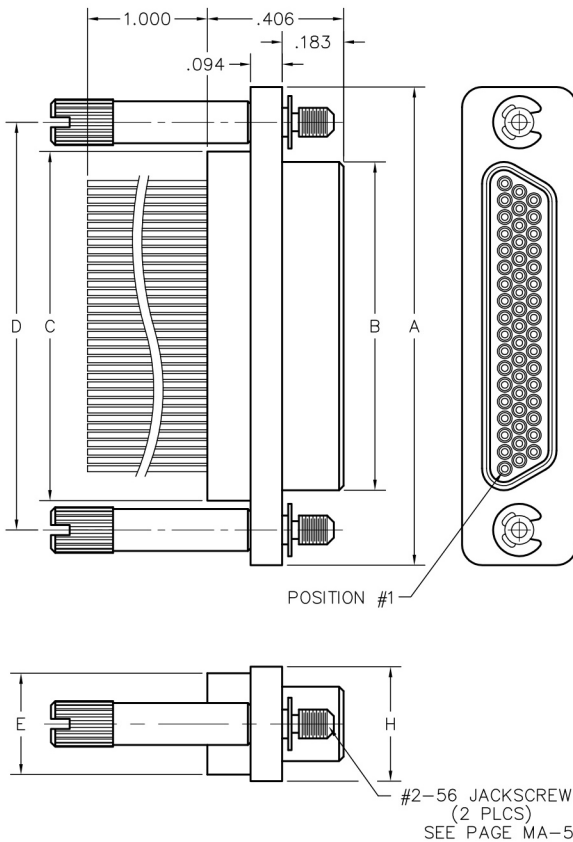

PLUG

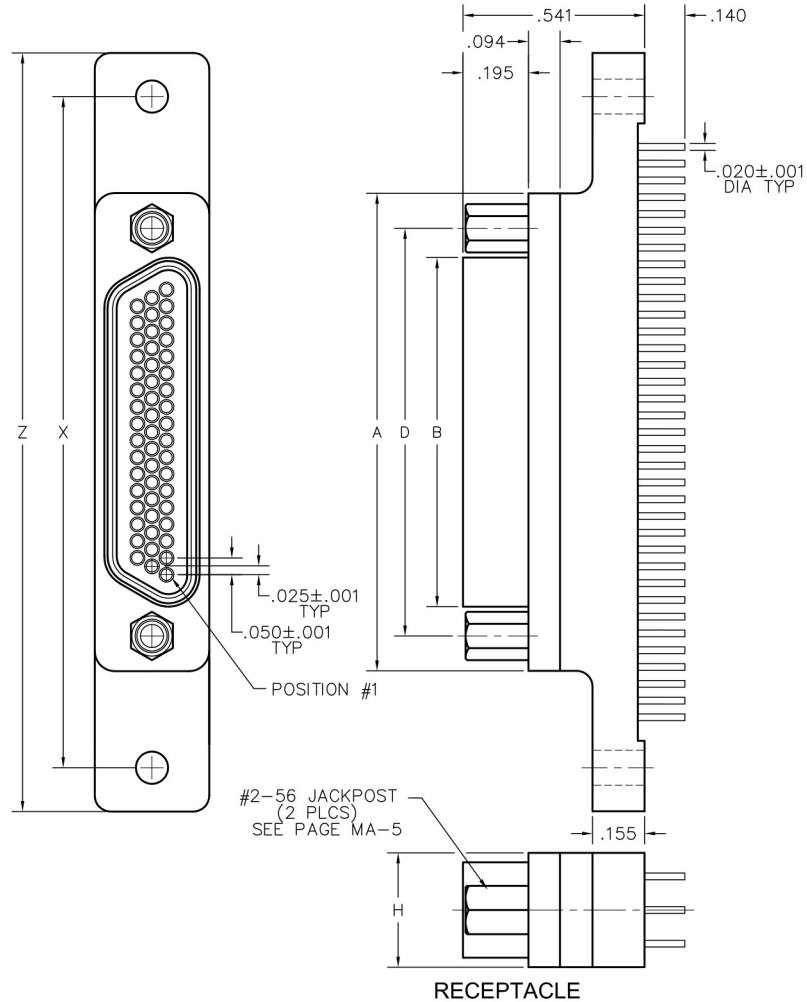

RECEPTACLE

SIZE	CONTACT ROWS	DIMENSIONS										HARDWARE	MOUNTING HOLE
		B		C	D	E		H	X	Z MAX			
		PLUG MAX	RCPT MAX			POTTING WELL MAX							
9	2	.775	.334	.400	.390	.565	.270	.298	1.150	1.390	#2-56 UNC THD (.092 DIA THRU)	.096 DIA OR #2-56 UNC THREADED INSERT	
15		.925	.484	.550	.540	.715			1.450	1.690			
21		1.075	.634	.700	.690	.865			1.500	1.740			
25		1.175	.734	.800	.790	.965			1.800	2.040			
31		1.325	.884	.950	.940	1.115			2.100	2.340			
37		1.475	1.034	1.100	1.090	1.265							
51	3	1.425	.984	1.050	1.040	1.215	.310	.341	2.000	2.270	#4-40 UNC THD (.147 DIA THRU)	.125 DIA OR #2-56 UNC THREADED INSERT	
100	4	2.160	1.384	1.508	1.432	1.800	.360	.384	2.800	3.240			



PLUG: MM-312-051-153-4400

RECEPTACLE: MK-322-051-235-2200

PLUG: MN-311-051-153-4400

RECEPTACLE: ML-321-051-235-2200

**PLUG**

**RECEPTACLE**

**SERIES** MM-312-051-153-4400 MK-322-051-235-2200  
 MN-311-051-153-4400 ML-321-051-235-2200  
 XX-XXX-XXX-XXX-XXXX-XXX

MM .050" Rugged Metal I/O Connector  
 MN .050" Rugged Plastic I/O Connector  
 (MM & MN mate with MK, ML, MM, MN receptacles)

MK .050" Rugged Metal PC Board Mount Connector  
 ML .050" Rugged Plastic PC Board Mount Connector  
 (MK & ML mate with MK, ML, MM, MN plugs)

**BODY**

- 2 2-Row (Sizes 9 thru 37)
- 3 3-Row (Size 51)
- 4 4-Row (Size 100)

- 2 2-Row (Sizes 9 thru 37)
- 3 3-Row (Size 51)
- 4 4-Row (Size 100)

**BODY STYLE:**  
 1 Plug, straight, with ears

**BODY STYLE:**  
 2 Receptacle, straight, narrow footprint, w/ mtg holes

- BODY MATERIAL:**
- 1 Polyphenylene Sulfide (MN only)
  - 2 Polyphenylene Sulfide with electroless nickel shell
  - 3 Polyphenylene Sulfide with electrodeposited cadmium shell
  - 4 Polyphenylene Sulfide with hard anodized black shell
  - 5 Polyphenylene Sulfide with stainless steel shell
  - A Pure Electro-Deposited Aluminum
  - K Zinc Nickel Plating
  - T Nickel Polymer Plating

- BODY MATERIAL:**
- 1 Polyphenylene Sulfide (ML only)
  - 2 Polyphenylene Sulfide with electroless nickel shell
  - 3 Polyphenylene Sulfide with electrodeposited cadmium shell
  - 4 Polyphenylene Sulfide with hard anodized black shell
  - 5 Polyphenylene Sulfide with stainless steel shell
  - A Pure Electro-Deposited Aluminum
  - K Zinc Nickel Plating
  - T Nickel Polymer Plating

**SIZE**

XXX 009, 015, 021, 025, 031, 037, 051, 100

XXX 009, 015, 021, 025, 031, 037, 051, 100

**CONTACTS**

- TYPE CONTACTS/TERMINATIONS:**
- 11 Pin, straight, solder cup
  - 14 Pin, straight, .500" pigtails (.018 dia)
  - 15 Pin, straight, 1.000" pigtails (.018 dia)
  - 16 Pin, straight, crimped wire

- TYPE CONTACTS/TERMINATIONS:**
- 22 Socket, straight, PCB leads, .109"
  - 23 Socket, straight, PCB leads, .140"
  - 24 Socket, straight, PCB leads, .172"

- PLATING OPTIONS:**
- 1 50 μ" Au contacts (crimp wire)
  - 3 50 μ" Au contacts; 10 μ" Au terminations (solder cup, pigtail)
  - 5 50 μ" Au contacts; Sn/Pb alloy terminations (pigtail)
  - 7 50 μ" Au contacts; SAC305 terminations (pigtail)

- PLATING OPTIONS:**
- 3 50 μ" Au contacts; 10 μ" Au terminations
  - 5 50 μ" Au contacts; Sn/Pb alloy terminations
  - 7 50 μ" Au contacts; SAC305 terminations

**HARDWARE**

- STYLE OF HARDWARE:**
- 00 None
  - 22 Two fixed jacknut assemblies (62\*)
  - 41 Two turning jackscrews, allen head, retaining ring (81\*)  
Two long turning jackscrews, allen head, retaining ring (82\*)
  - 43 Two turning jackscrews, slot head, retaining ring (83\*)
  - 44 Two long turning jackscrews, slot head, retaining ring (84\*)
  - 45 Two turning jackscrews, allen head, captivated\*\* (85\*)
  - 99 Keying hardware, see options below (Body material 2, 3 and 4 only)

- STYLE OF HARDWARE:**
- 00 None
  - 22 Two fixed jacknut assemblies (62\*)
  - 99 Keying hardware, see options below (Body material 2, 3 and 4 only)

**POLARIZATION / WIRING:**  
 00 None  
 XX For wiring codes, see page MA-3 & MA-4

**POLARIZATION / WIRING**  
 00 None

**OPTIONS**

KSXX Two turning jackscrews. See page MA-6 for keying options (KJ\*)

KPXX Two fixed jacknuts and interfacial sealing gasket. See page MA-6 for keying options (KN\*)  
 900 Interfacial sealing gasket  
 0B7 Threaded inserts and interfacial sealing gasket

\* = Use numbers or letters in parenthesis when ordering size 100.

\*\* = Captive hardware is factory installed and non-removable.

= Option not RoHS compliant



MM-322-051-253-4400  
(METAL)  
MN-321-051-253-4400  
(PLASTIC)

# Cable to Board (Narrow Footprint)

.050"

9 thru 100 Contacts

Rugged Cable Rugged Board Mount

**MM, MN**

**MK, ML**

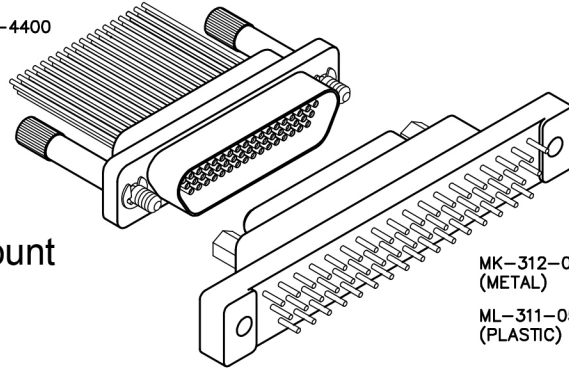

MK-312-051-135-2200  
(METAL)  
ML-311-051-135-2200  
(PLASTIC)

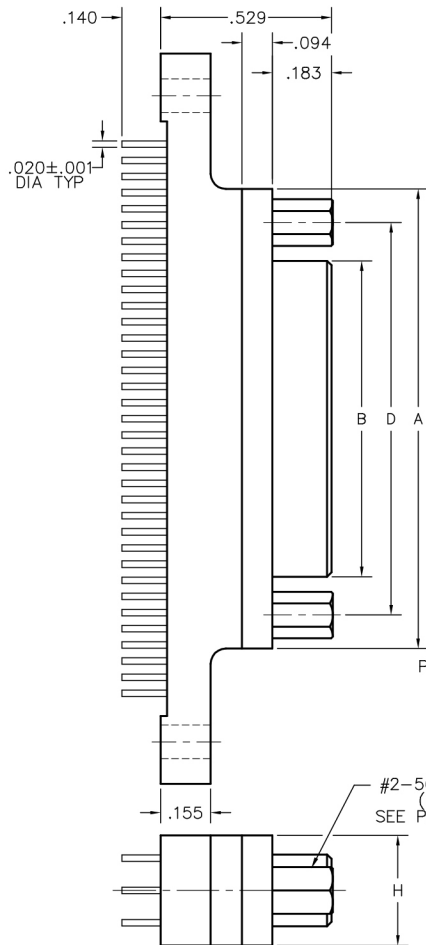

PLUG

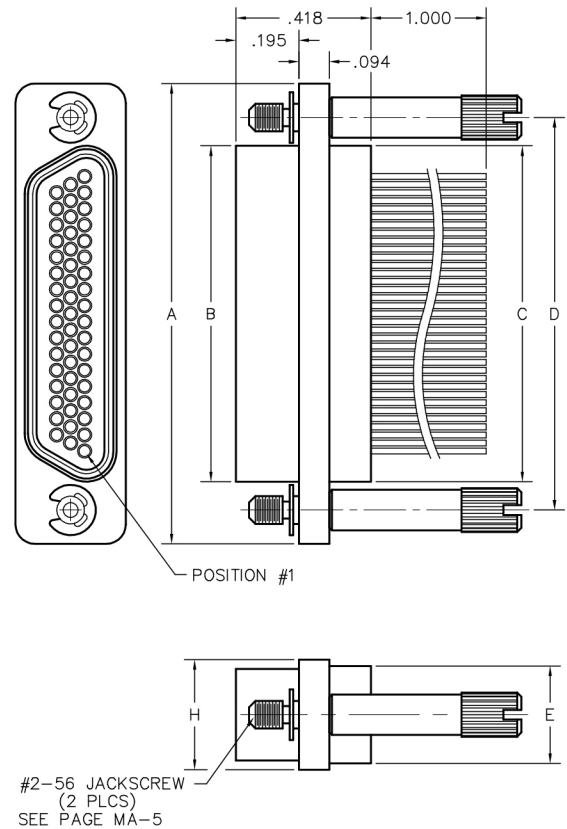
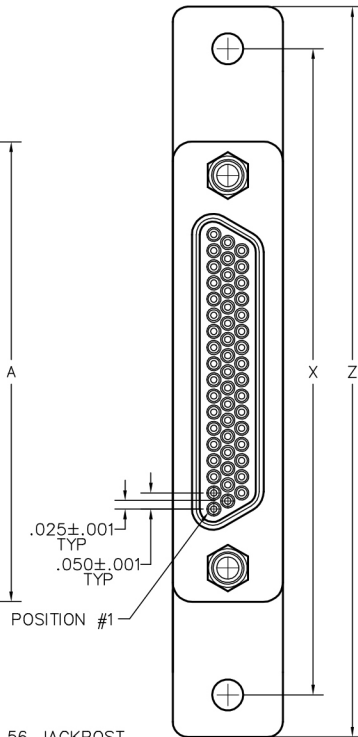

RECEPTACLE

SIZE	CONTACT ROWS	DIMENSIONS										
		A	B		C	D	E POTTING WELL MAX	H	X	Z MAX	HARDWARE	MOUNTING HOLE
			PLUG MAX	RCPT MAX								
9	2	.775	.334	.400	.390	.565	.270	.298	1.150	1.390	#2-56 UNC THD	.096 DIA OR #2-56 UNC THREADED INSERT
15		.925	.484	.550	.540	.715			1.450	1.690		
21		1.075	.634	.700	.690	.865			1.500	1.740		
25		1.175	.734	.800	.790	.965			1.800	2.040		
31		1.325	.884	.950	.940	1.115			2.100	2.340		
37		1.475	1.034	1.100	1.090	1.265						
51	3	1.425	.984	1.050	1.040	1.215	.310	.341	2.000	2.270		
100	4	2.160	1.384	1.508	1.432	1.800	.360	.384	2.800	3.240	#4-40 UNC THD	.125 DIA OR #2-56 UNC THREADED INSERT



**PLUG:** MK-312-051-135-2200  
**RECEPTACLE:** MM-322-051-253-4400  
**PLUG:** ML-311-051-135-2200  
**RECEPTACLE:** MN-321-051-253-4400

**PLUG**

**RECEPTACLE**

SERIES	
MK .050" Rugged Metal PC Board Mount Connector	MM .050" Rugged Metal I/O Connector
ML .050" Rugged Plastic PC Board Mount Connector (MK & ML mate with MK, ML, MM, MN receptacles)	MN .050" Rugged Plastic I/O Connector (MM & MN mate with MK, ML, MM, MN plugs)

BODY	
2 2-Row (Sizes 9 thru 37)	2 2-Row (Sizes 9 thru 37)
3 3-Row (Size 51)	3 3-Row (Size 51)
4 4-Row (Size 100)	4 4-Row (Size 100)
<b>BODY STYLE:</b> 1 Plug, straight, narrow footprint, w/ mtg holes	<b>BODY STYLE:</b> 2 Receptacle, straight, with ears
<b>BODY MATERIAL:</b> 1 Polyphenylene Sulfide (ML only) 2 Polyphenylene Sulfide with electroless nickel shell 3 Polyphenylene Sulfide with electrodeposited cadmium shell <input checked="" type="checkbox"/> 4 Polyphenylene Sulfide with hard anodized black shell 5 Polyphenylene Sulfide with stainless steel shell A Pure Electro-Deposited Aluminum K Zinc Nickel Plating T Nickel Polymer Plating	<b>BODY MATERIAL:</b> 1 Polyphenylene Sulfide (MN only) 2 Polyphenylene Sulfide with electroless nickel shell 3 Polyphenylene Sulfide with electrodeposited cadmium shell <input checked="" type="checkbox"/> 4 Polyphenylene Sulfide with hard anodized black shell 5 Polyphenylene Sulfide with stainless steel shell A Pure Electro-Deposited Aluminum K Zinc Nickel Plating T Nickel Polymer Plating

SIZE	
XXX 009, 015, 021, 025, 031, 037, 051, 100	XXX 009, 015, 021, 025, 031, 037, 051, 100

CONTACTS	
<b>TYPE CONTACTS/TERMINATIONS:</b> 12 Pin, straight, PCB leads, .109" 13 Pin, straight, PCB leads, .140" 14 Pin, straight, PCB leads, .172"	<b>TYPE CONTACTS/TERMINATIONS:</b> 21 Socket, straight, solder cup 24 Socket, straight, .500" pigtails (.018 dia) 25 Socket, straight, 1,000" pigtails (.018 dia) 26 Socket, straight, crimped wire
<b>PLATING OPTIONS:</b> 3 50 μ" Au contacts: 10 μ" Au terminations 5 50 μ" Au contacts: Sn/Pb alloy terminations <input checked="" type="checkbox"/> 7 50 μ" Au contacts; SAC305 terminations	<b>PLATING OPTIONS:</b> 1 50 μ" Au contacts (crimp wire) 3 50 μ" Au contacts: 10 μ" Au terminations (solder cup, pigtail) 5 50 μ" Au contacts; Sn/Pb alloy terminations (pigtail) <input checked="" type="checkbox"/> 7 50 μ" Au contacts; SAC305 terminations (pigtail)

HARDWARE	
<b>STYLE OF HARDWARE:</b> 00 None 22 Two fixed jacknut assemblies (62*) 99 Keying hardware, see options below (Body material 2, 3 and 4 only)	<b>STYLE OF HARDWARE:</b> 00 None 22 Two fixed jacknut assemblies (62*) 41 Two turning jackscrews, allen head, retaining ring (81*) 42 Two long turning jackscrews, allen head, retaining ring (82*) 43 Two turning jackscrews, slot head, retaining ring (83*) 44 Two long turning jackscrews, slot head, retaining ring (84*) 45 Two turning jackscrews, allen head, captivated** (85*) 99 Keying hardware, see options below (Body material 2, 3 and 4 only)
<b>POLARIZATION / WIRING:</b> 00 None	<b>POLARIZATION / WIRING:</b> 00 None XX For wiring codes, see page MA-3 & MA-4

OPTIONS	
KPXX Two fixed jacknuts. See page MA-6 for keying options (KN*)	KSXX Two turning jackscrews and interfacial sealing gasket. See page MA-6 for keying options (KJ*)
OB7 Threaded inserts	900 Interfacial sealing gasket

\* = Use numbers or letters in parenthesis when ordering size 100.  
 \*\* = Captive hardware is factory installed and non-removable.  
 = Option not RoHS compliant



# Recommended PC Board Layout

Straight, Narrow Footprint

## PLUG PC BOARD LAYOUT COMPONENT SIDE

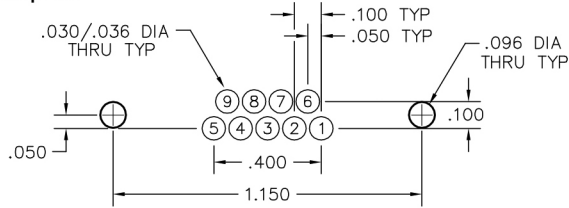

### CONNECTOR MATING FACE (PLUG)



9 POSITION

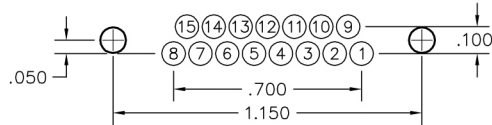

15 POSITION

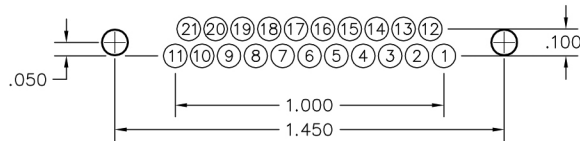

21 POSITION

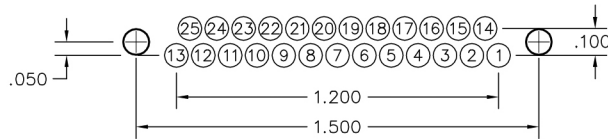

25 POSITION

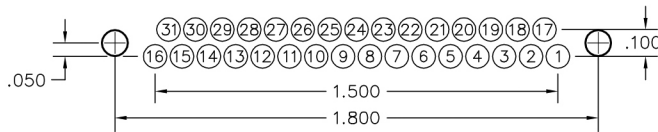

31 POSITION

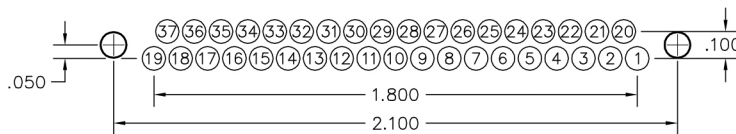

37 POSITION

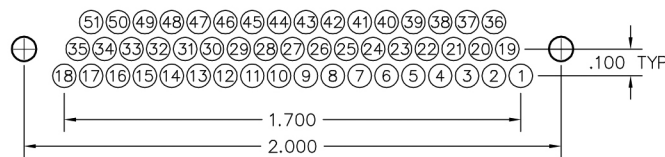

51 POSITION

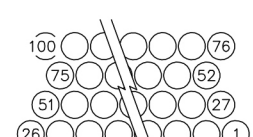
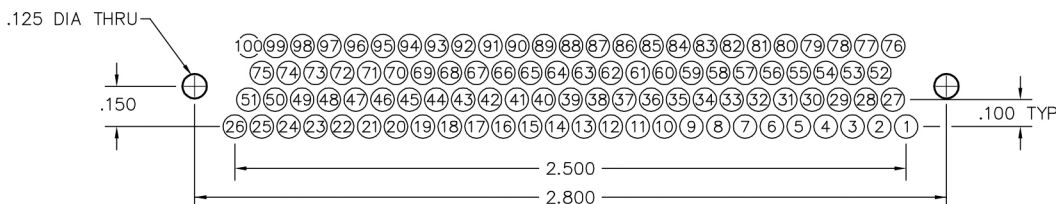

100 POSITION

## Recommended PC Board Layout

### Straight, Narrow Footprint

CONNECTOR  
MATING FACE  
(RECEPTACLE)

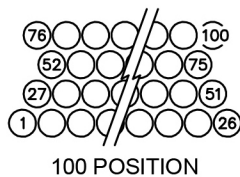
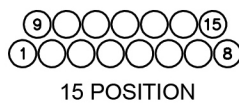

RECEPTACLE  
PC BOARD LAYOUT  
COMPONENT SIDE

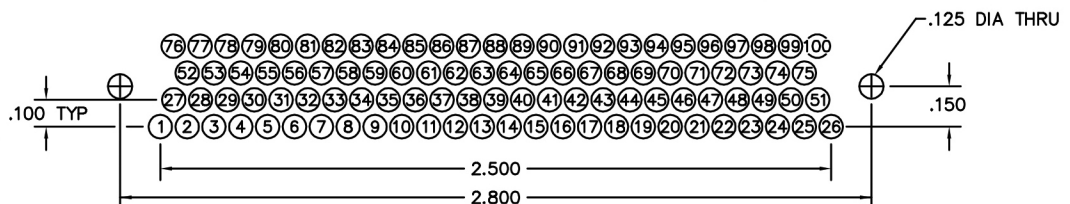
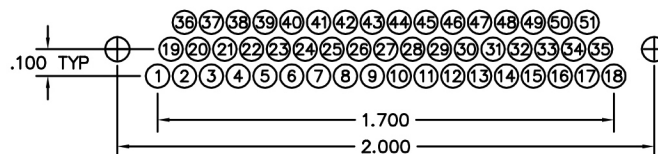
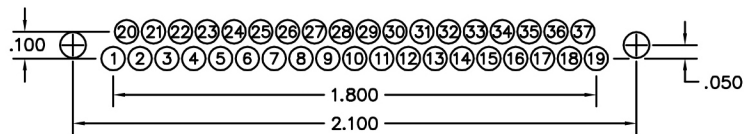
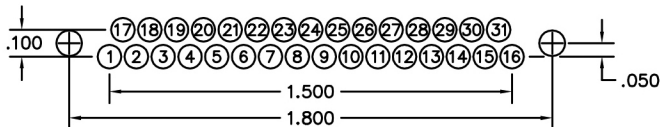
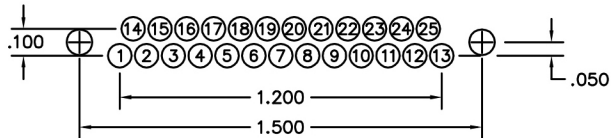
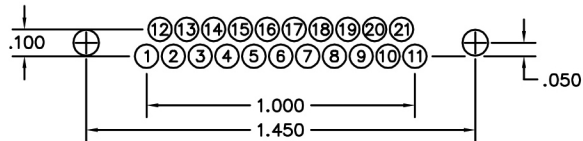
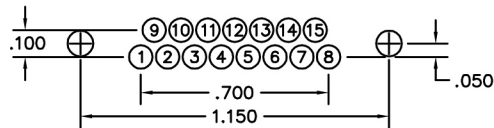
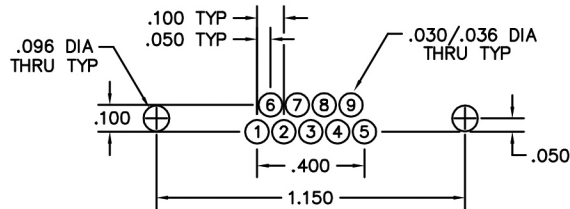



# Cable to Board (Standard Footprint)

.050"  
9 thru 100 Contacts  
Rugged Cable

**MM, MN**

Rugged Board Mount

**MK, ML**

MM-312-051-161-45WP  
(METAL)

MN-311-051-161-45WP  
(PLASTIC)

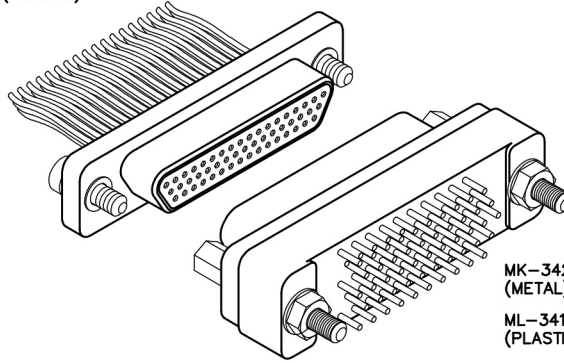

MK-342-051-225-2200  
(METAL)

ML-341-051-225-2200  
(PLASTIC)

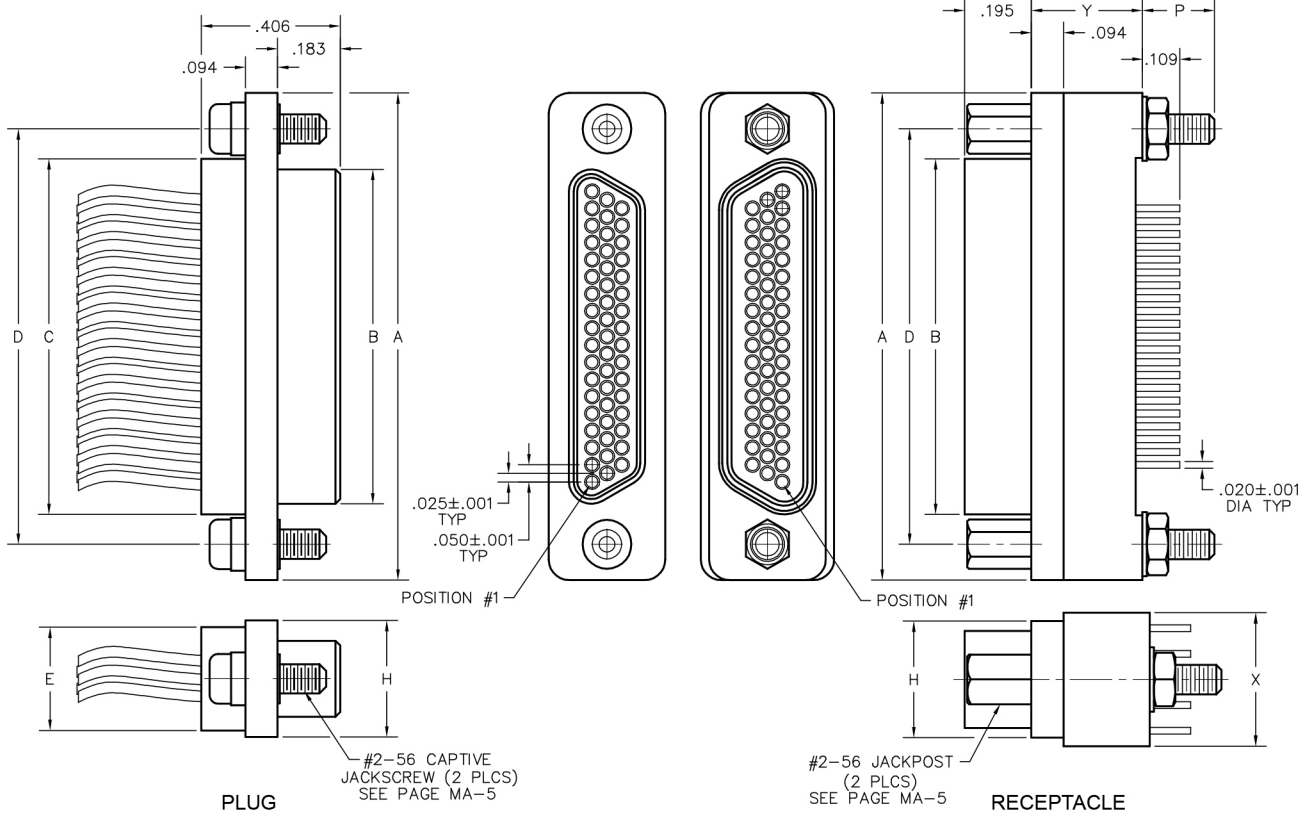

SIZE	CONTACT ROWS	DIMENSIONS										HARDWARE	
		A	B		C	D	E		H	P	X		Y
			PLUG MAX	RCPT MAX			POTTING WELL MAX						
9	2	.775	.334	.400	.390	.565	.270	.298	.210	.298	.280	1.080	.390
15		.925	.484	.550	.540	.715							.540
21		1.075	.634	.700	.690	.865							.690
25		1.175	.734	.800	.790	.965							.780
31		1.325	.884	.950	.940	1.115							.930
37	1.475	1.034	1.100	1.090	1.265	.214	.330	1.080					
51	3	1.425	.984	1.050	1.040	1.215	.310	.341	.219	.390	.325	1.046	1.046
69		1.725	1.284	1.350	1.340	1.515							1.346
100		2.160	1.384	1.508	1.432	1.800							.360

\* = 69 POSITION CONNECTORS ARE AVAILABLE IN METAL ONLY.  
\*\* = "Z" DIMENSION FOR TURNING JACKSCREW ONLY

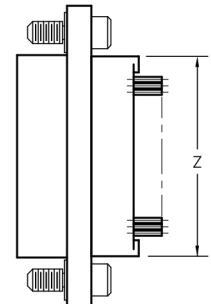



**PLUG:** MM-312-051-161-45WP  
**RECEPTACLE:** MK-342-051-225-2200  
**PLUG:** MN-311-051-161-45WP  
**RECEPTACLE:** ML-341-051-225-2200  
 XX-XXX-XXX-XXX-XXXX-XXX

PLUG		RECEPTACLE	
<b>SERIES</b>			
MM .050" Rugged Metal I/O Connector	MN .050" Rugged Plastic I/O Connector (MM & MN mate with MK, ML, MM, MN receptacles)	MK .050" Rugged Metal PC Board Mount Connector	ML .050" Rugged Plastic PC Board Mount Connector (MK & ML mate with MK, ML, MM, MN plugs)
<b>BODY</b>			
2 2-Row (Sizes 9 thru 37)	3 3-Row (Size 51 & 69***)	4 4-Row (Size 100)	
BODY STYLE: 1 Plug, straight, with ears		BODY STYLE: 4 Receptacle, straight, standard footprint	
BODY MATERIAL: 1 Polyphenylene Sulfide (MN only) 2 Polyphenylene Sulfide with electroless nickel shell 3 Polyphenylene Sulfide with electrodeposited cadmium shell <input checked="" type="checkbox"/> 4 Polyphenylene Sulfide with hard anodized black shell 5 Polyphenylene Sulfide with stainless steel shell A Pure Electro-Deposited Aluminum K Zinc Nickel Plating T Nickel Polymer Plating		BODY MATERIAL: 1 Polyphenylene Sulfide (ML only) 2 Polyphenylene Sulfide with electroless nickel shell 3 Polyphenylene Sulfide with electrodeposited cadmium shell <input checked="" type="checkbox"/> 4 Polyphenylene Sulfide with hard anodized black shell 5 Polyphenylene Sulfide with stainless steel shell A Pure Electro-Deposited Aluminum K Zinc Nickel Plating T Nickel Polymer Plating	
<b>SIZE</b>			
XXX 009, 015, 021, 025, 031, 037, 051, 069***, 100		XXX 009, 015, 021, 025, 031, 037, 051, 069***, 100	
<b>CONTACTS</b>			
TYPE CONTACTS/TERMINATIONS: 11 Pin, straight, solder cup 14 Pin, straight, .500" pigtails (.018 dia) 15 Pin, straight, 1.000" pigtails (.018 dia) 16 Pin, straight, crimped wire		TYPE CONTACTS/TERMINATIONS: 22 Socket, straight, PCB leads, .109" 23 Socket, straight, PCB leads, .140" 24 Socket, straight, PCB leads, .172"	
PLATING OPTIONS: 1 50 μ" Au contacts (crimp wire) 3 50 μ" Au contacts; 10 μ" Au terminations (solder cup, pigtail) 5 50 μ" Au contacts; Sn/Pb alloy terminations (pigtail) <input checked="" type="checkbox"/> 7 50 μ" Au contacts; SAC305 terminations (pigtail)		PLATING OPTIONS: 3 50 μ" Au contacts; 10 μ" Au terminations 5 50 μ" Au contacts; Sn/Pb alloy terminations <input checked="" type="checkbox"/> 7 50 μ" Au contacts; SAC305 terminations	
<b>HARDWARE</b>			
STYLE OF HARDWARE: 00 None 22 Two fixed jacknut assemblies (62*) 41 Two turning jackscrews, allen head, retaining ring (81*) 42 Two long turning jackscrews, allen head, retaining ring (82*) 43 Two turning jackscrews, slot head, retaining ring (83*) 44 Two long turning jackscrews, slot head, retaining ring (84*) 45 Two turning jackscrews, allen head, captivated** (85*) 99 Keying hardware, see options below (Body material 2, 3 and 4 only)		STYLE OF HARDWARE: 00 None 22 Two fixed jacknut assemblies (62*) 41 Two turning jackscrews, allen head, retaining ring**** (81*) 99 Keying hardware, see options below (Body material 2, 3 and 4 only)	
POLARIZATION / WIRING: 00 None XX For wiring codes, see page MA-3 & MA-4		POLARIZATION / WIRING 00 None	
<b>OPTIONS</b>			
KSXX Two turning jackscrews. See page MA-6 for keying options (KJ*)		KPXX Two fixed jacknuts and interfacial sealing gasket. See page MA-6 for keying options (KN*) 900 Interfacial sealing gasket 0B7 Threaded inserts and interfacial sealing gasket	

\* = Use numbers or letters in parenthesis when ordering size 100.      \*\*\* = 69 position connectors are available in metal only.  
 \*\* = Captive hardware is factory installed and non-removable.      \*\*\*\* = Connector body has no mounting holes.  
 = Option not RoHS compliant



# Cable to Board (Standard Footprint)

.050"

9 thru 100 Contacts

Rugged Cable

**MM, MN**

Rugged Board Mount

**MK, ML**

MM-322-051-261-45WP  
(METAL)

MN-321-051-261-45WP  
(PLASTIC)

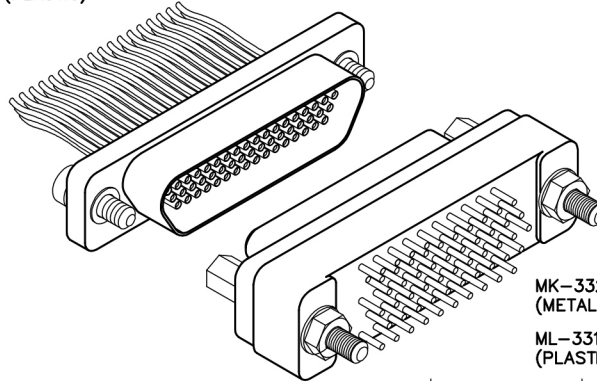

MK-332-051-125-2200  
(METAL)

ML-331-051-125-2200  
(PLASTIC)

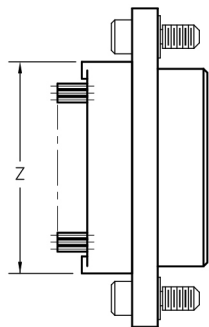
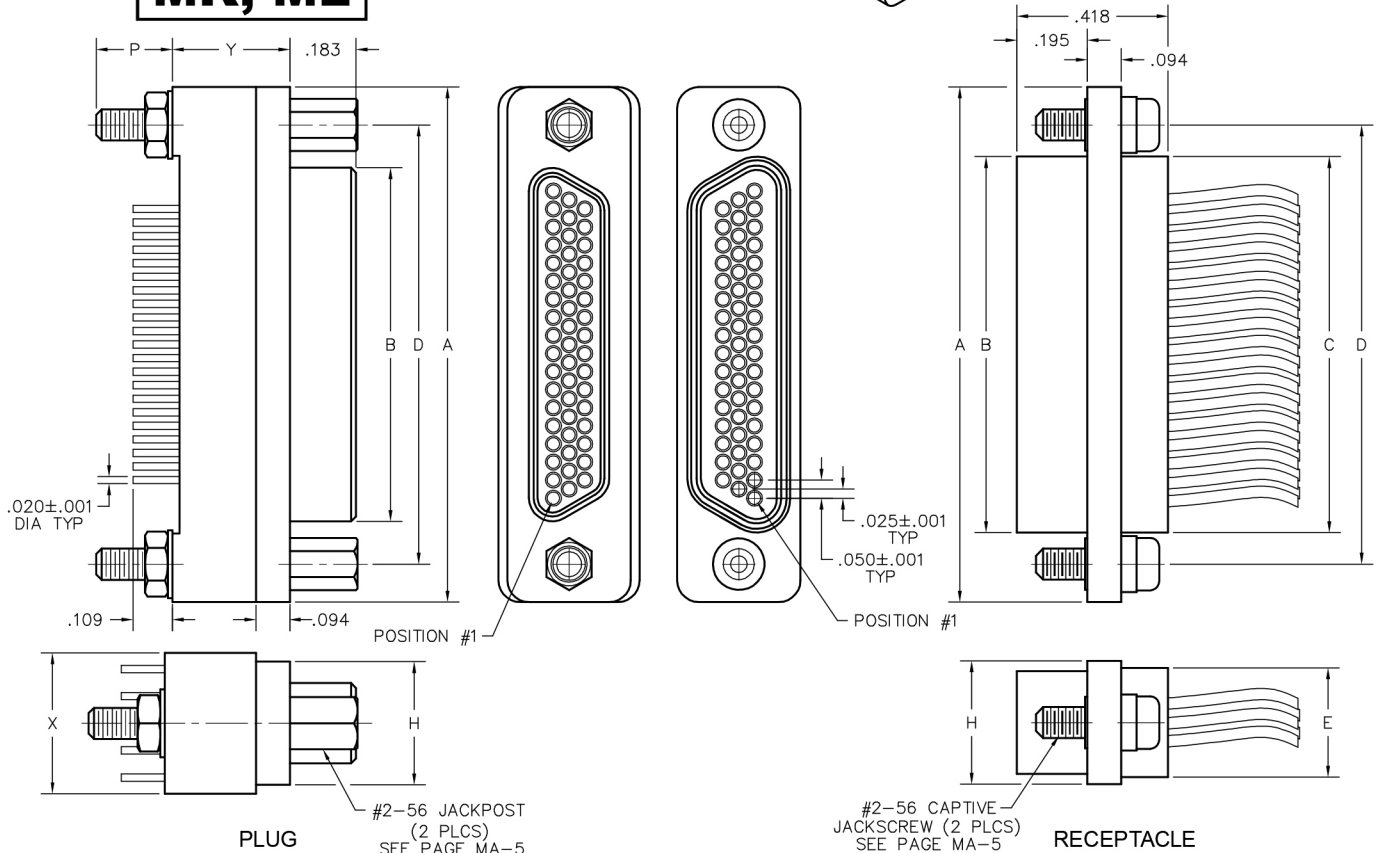

SIZE	CONTACT ROWS	DIMENSIONS											HARDWARE					
		A	B		C	D	E	H	P	X	Y	Z**						
			PLUG MAX	RCPT MAX										POTTING WELL MAX				
9	2	.775	.334	.400	.390	.565	.270	.298	.210	.298	.280	.390	#2-56 UNC THD (#2-56 CLEARANCE OR #2-56 UNC THREADED INSERT)					
15		.925	.484	.550	.540	.715						.540						
21		1.075	.634	.700	.690	.865						.690						
25		1.175	.734	.800	.790	.965						.780						
31		1.325	.884	.950	.940	1.115						.930						
37		1.475	1.034	1.100	1.090	1.265						.930						
51	3	1.425	.984	1.050	1.040	1.215	.310	.341	.219	.390	.325	1.046	#4-40 UNC THD (#4-40 CLEARANCE OR #4-40 UNC THREADED INSERT)					
69		1.725	1.284	1.350	1.340	1.515						1.346						
100		2.160	1.384	1.508	1.432	1.800						.360		.384	.216	.490	.379	1.530

\* = 69 POSITION CONNECTORS ARE AVAILABLE IN METAL ONLY.  
\*\* = "Z" DIMENSION FOR TURNING JACKSCREW ONLY



PLUG: MK-332-051-125-2200

RECEPTACLE: MM-322-051-261-45WP

PLUG: ML-331-051-125-2200

RECEPTACLE: MN-321-051-261-45WP

**PLUG**

**RECEPTACLE**

XX-XXX-XXX-XXX-XXXX-XXX

SERIES	
MK .050" Rugged Metal PC Board Mount Connector ML .050" Rugged Plastic PC Board Mount Connector (MK & ML mate with MK, ML, MM, MN receptacles)	MM .050" Rugged Metal I/O Connector MN .050" Rugged Plastic I/O Connector (MM & MN mate with MK, ML, MM, MN plugs)
BODY	
2 2-Row (Sizes 9 thru 37) 3 3-Row (Size 51 & 69***) 4 4-Row (Size 100)	2 2-Row (Sizes 9 thru 37) 3 3-Row (Size 51 & 69***) 4 4-Row (Size 100)
BODY STYLE: 3 Plug, straight, standard footprint	BODY STYLE: 2 Receptacle, straight, with ears
BODY MATERIAL: 1 Polyphenylene Sulfide (ML only) 2 Polyphenylene Sulfide with electroless nickel shell 3 Polyphenylene Sulfide with electrodeposited cadmium shell <input checked="" type="checkbox"/> 4 Polyphenylene Sulfide with hard anodized black shell 5 Polyphenylene Sulfide with stainless steel shell A Pure Electro-Deposited Aluminum K Zinc Nickel Plating T Nickel Polymer Plating	BODY MATERIAL: 1 Polyphenylene Sulfide (MN only) 2 Polyphenylene Sulfide with electroless nickel shell 3 Polyphenylene Sulfide with electrodeposited cadmium shell <input checked="" type="checkbox"/> 4 Polyphenylene Sulfide with hard anodized black shell 5 Polyphenylene Sulfide with stainless steel shell A Pure Electro-Deposited Aluminum K Zinc Nickel Plating T Nickel Polymer Plating
SIZE	
XXX 009, 015, 021, 025, 031, 037, 051, 069***, 100	XXX 009, 015, 021, 025, 031, 037, 051, 069***, 100
CONTACTS	
TYPE CONTACTS/TERMINATIONS: 12 Pin, straight, PCB leads, .109" 13 Pin, straight, PCB leads, .140" 14 Pin, straight, PCB leads, .172"	TYPE CONTACTS/TERMINATIONS: 21 Socket, straight, solder cup 24 Socket, straight, .500" pigtails (.018 dia) 25 Socket, straight, 1.000" pigtails (.018 dia) 26 Socket, straight, crimped wire
PLATING OPTIONS: 3 50 μ" Au contacts: 10 μ" Au terminations 5 50 μ" Au contacts; Sn/Pb alloy terminations <input checked="" type="checkbox"/> 7 50 μ" Au contacts; SAC305 terminations	PLATING OPTIONS: 1 50 μ" Au contacts (crimp wire) 3 50 μ" Au contacts: 10 μ" Au terminations (solder cup, pigtail) 5 50 μ" Au contacts; Sn/Pb alloy terminations (pigtail) <input checked="" type="checkbox"/> 7 50 μ" Au contacts; SAC305 terminations (pigtail)
HARDWARE	
STYLE OF HARDWARE: 00 None 22 Two fixed jacknut assemblies (62*) 41 Two turning jackscrews, allen head, retaining ring**** (81*) 99 Keying hardware, see options below (Body material 2, 3 and 4 only)	STYLE OF HARDWARE: 00 None 22 Two fixed jacknut assemblies (62*) 41 Two turning jackscrews, allen head, retaining ring (81*) 42 Two long turning jackscrews, allen head, retaining ring (82*) 43 Two turning jackscrews, slot head, retaining ring (83*) 44 Two long turning jackscrews, slot head, retaining ring (84*) 45 Two turning jackscrews, allen head, captivated** (85*) 99 Keying hardware, see options below (Body material 2, 3 and 4 only)
POLARIZATION / WIRING: 00 None	POLARIZATION / WIRING 00 None XX For wiring codes, see page MA-3 & MA-4
OPTIONS	
KPXX Two fixed jacknuts. See page MA-6 for keying options (KN*) OB7 Threaded inserts	KSXX Two turning jackscrews and interfacial sealing gasket. See page MA-6 for keying options (KJ*) 900 Interfacial sealing gasket

\* = Use numbers or letters in parenthesis when ordering size 100.

\*\*\* = 69 position connectors are available in metal only.

\*\* = Captive hardware is factory installed and non-removable.

\*\*\*\* = Connector body has no mounting holes.

= Option not RoHS compliant



# Recommended PC Board Layout

## Straight, Standard Footprint

CONNECTOR MATING FACE (PLUG)



PLUG  
PC BOARD LAYOUT  
COMPONENT SIDE

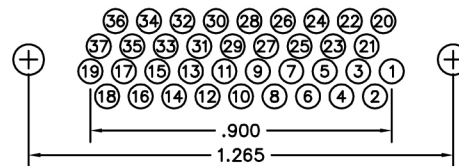
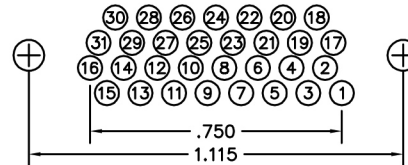
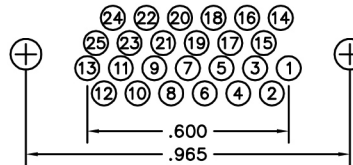
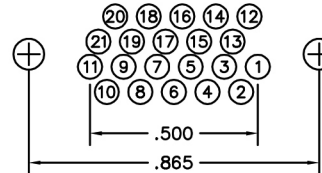
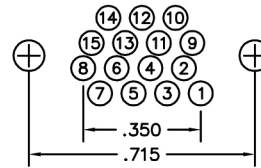
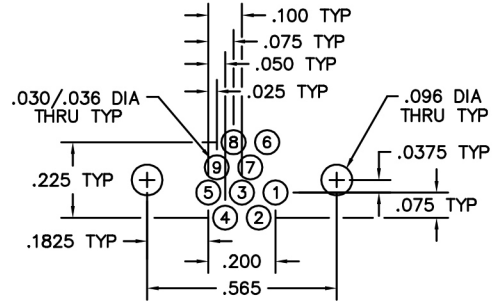

## Recommended PC Board Layout

**Straight, Standard Footprint**

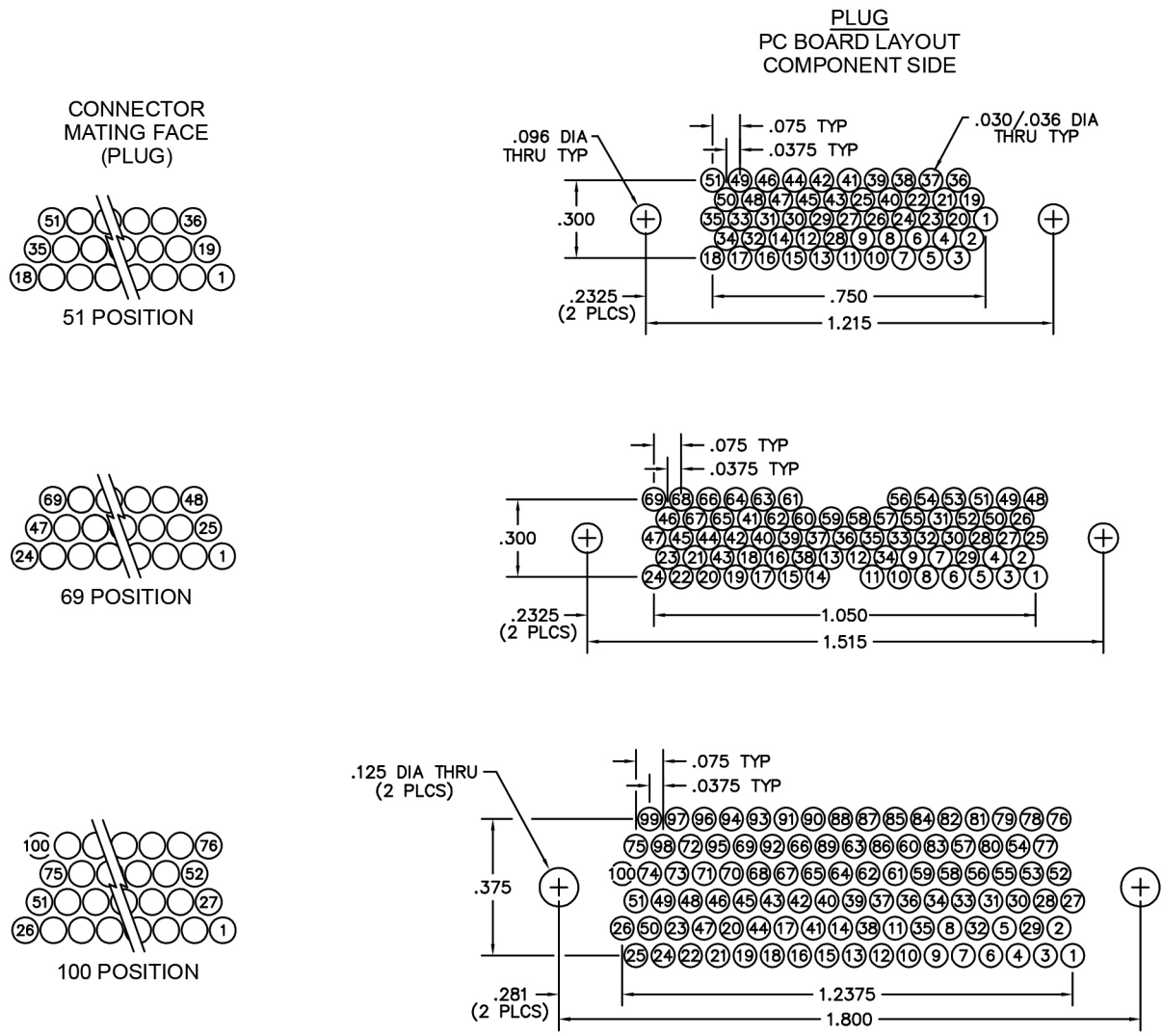



# Recommended PC Board Layout

Straight, Standard Footprint

RECEPTACLE  
PC BOARD LAYOUT  
COMPONENT SIDE

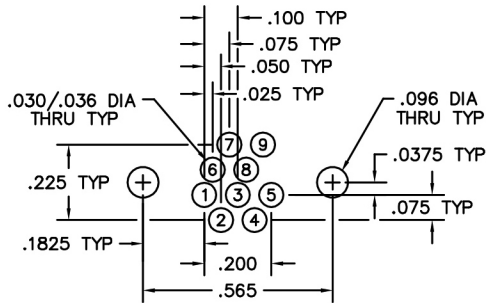

CONNECTOR  
MATING FACE  
(RECEPTACLE)



9 POSITION

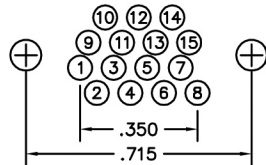

15 POSITION

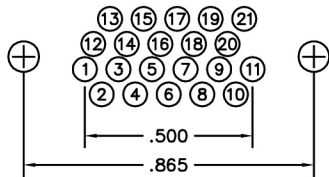

21 POSITION

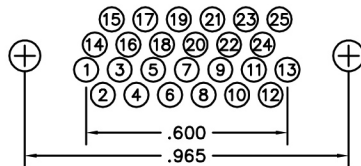

25 POSITION

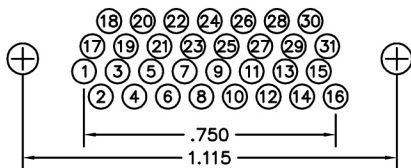

31 POSITION

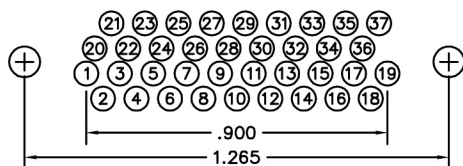

37 POSITION



# Recommended PC Board Layout

Straight, Standard Footprint

RECEPTACLE  
PC BOARD LAYOUT  
COMPONENT SIDE

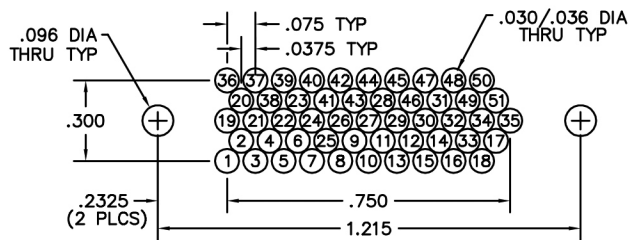

CONNECTOR  
MATING FACE  
(RECEPTACLE)



51 POSITION

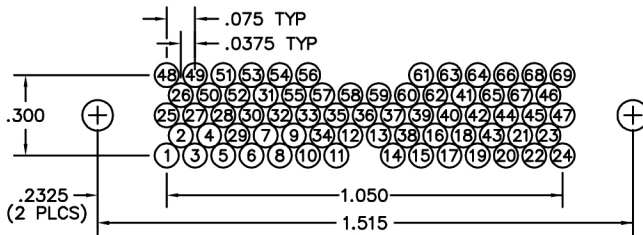

69 POSITION

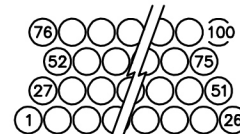
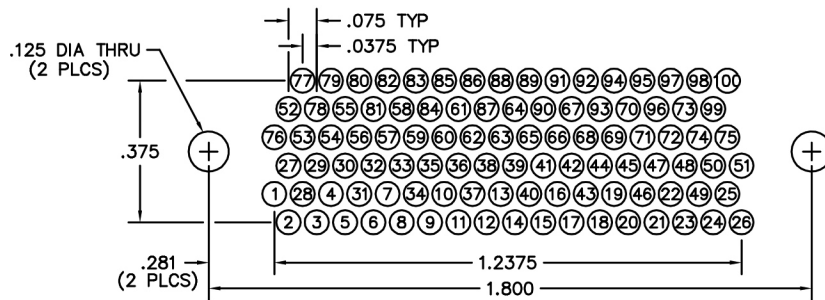

100 POSITION



## Specifications - Surface Mount Connectors Materials and Finishes \*

<b>Contacts:</b>	Pins: BeCu alloy strip per ASTM B194 Sockets: Brass per ASTM B121 / B121M or ASTM B16 / B16M or ASTM B453
<b>Contact Finish:</b>	Gold plate per ASTM B488
<b>Shells:</b>	Aluminum Alloy 6061-T6 per SAE AMS-QQ-A-250/11 or 6061-T6511 per SAE AMS-QQ-A-200/8 or Stainless Steel 300 series per ASTM A484 / A484M and ASTM A582 / A582M Passivated per SAE AMS2700
<b>Aluminum Shell Finishes:</b>	Electroless Nickel per SAE AMS2404, Class 3, 500 $\mu$ " min Electrodeposited Cadmium per SAE AMS-QQ-P-416, Type II, Class 3 Black Anodized per MIL-A-8625, Type III, Class 2
<b>Molded Insulators:</b>	Glass filled polyphenylene sulfide per MIL-M-24519
<b>Embedment:</b>	Frey Engineering Co. insulating compound CF3003-80 and L-II-49 or equivalent
<b>Jackscrews, Jackposts and Nuts:</b>	Corrosion resistant steel per ASTM A320 or ASTM A484 / A484M and ASTM A582 / A582M Passivated per SAE AMS2700
<b>Clips and Washers:</b>	Corrosion resistant steel per ASME 18.24 or NASM35333 or ASTM A484/A484M and ASTM A582/A582M (For reference only: ASME 18.24 CRS per ASTM A693 and NASM35333 CRS per ASTM A240) Passivated per ASME 18.24 or NASM35333 or SAE AMS2700 (For reference only: ASME 18.24 and NASM35333 passivated per SAE AMS2700)
<b>Brackets:</b>	Card Edge Mount: Aluminum Alloy 7075-T6 per SAE AMS-QQ-A-250/12 or SAE AMS-QQ-A-200/11 Plating consistent with Aluminum Shell  Horizontal Surface Mount: Corrosion resistant steel per ASTM A240 Passivated per SAE AMS2700
<b>Interfacial Seal Gaskets:</b>	Fluorosilicone per SAE AMS-R-25988
<b>Tolerances:</b>	Unless otherwise specified: Fractions = $\pm 1/64$ " Decimals = $\pm 0.010$ " Angles = $\pm 5^\circ$ Wire lengths: uninsulated/solid = $+0.2"/-0.0$ "

Note: AirBorn can manufacture special configurations for your exact specifications.

\* = Reference the above listed specifications or an equivalent industry standard when applicable

## Performance - Surface Mount Connectors

<b>Contact Rating:</b>	3-amperes maximum
<b>Solderability:</b>	Terminals (except crimp) tested in accordance with MIL-STD-202, Method 208
<b>Wire Size:</b>	Solid #30 AWG standard (consult factory for other sizes and types)
<b>Test Voltage:</b>	600 V, RMS, 60 Hz
<b>Operating Temperature:</b>	-55° C to +125° C
<b>Insulation Resistance:</b>	5,000 megohms minimum @ 500 VDC
<b>Durability:</b>	500 connector mating cycles
<b>Vibration:</b>	Tested in accordance with MIL-STD-1344, Method 2005, Condition IV, according to MIL-83513
<b>Shock:</b>	Tested in accordance with MIL-STD-1344, Method 2004, Condition E, according to MIL-83513
<b>Salt Spray:</b>	Mated connectors tested in accordance with MIL-STD-1344, Method 1001, Test Condition B
<b>Humidity:</b>	Mated connectors tested in accordance with MIL-STD-1344, Method 1002, Type II (except steps 7a and 7b)
<b>Thermal Shock:</b>	Tested to the temperature extremes of MIL-STD-1344, Method 1003, Test Condition A (except step 3, temperature shall be 125° C)
<b>Contact Resistance:</b>	0.065 volt maximum drop @ 2.5 amps (.026 ohms)
<b>Contact Engaging Force:</b>	6.0 ounce maximum, with .0221 diameter test sleeve
<b>Contact Separating Force:</b>	0.5 ounce minimum, with .0230 diameter test sleeve
<b>Crimp Strength:</b>	5 pound minimum tensile strength



**Board SMT  
to Cable  
.050"**

**9 thru 51 Contacts**

**Rugged Metal**

**MM**

**Rugged Plastic**

**MN**

MM-223-025-275-320S  
(METAL)  
MN-221-025-275-320S  
(PLASTIC)

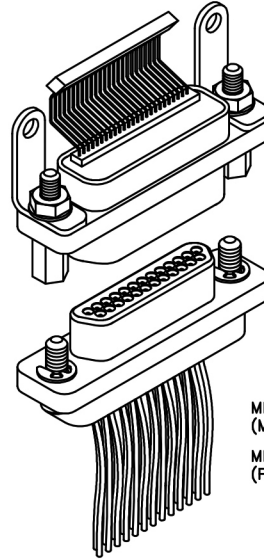

MM-213-025-161-41WQ  
(METAL)  
MN-211-025-161-41WQ  
(PLASTIC)

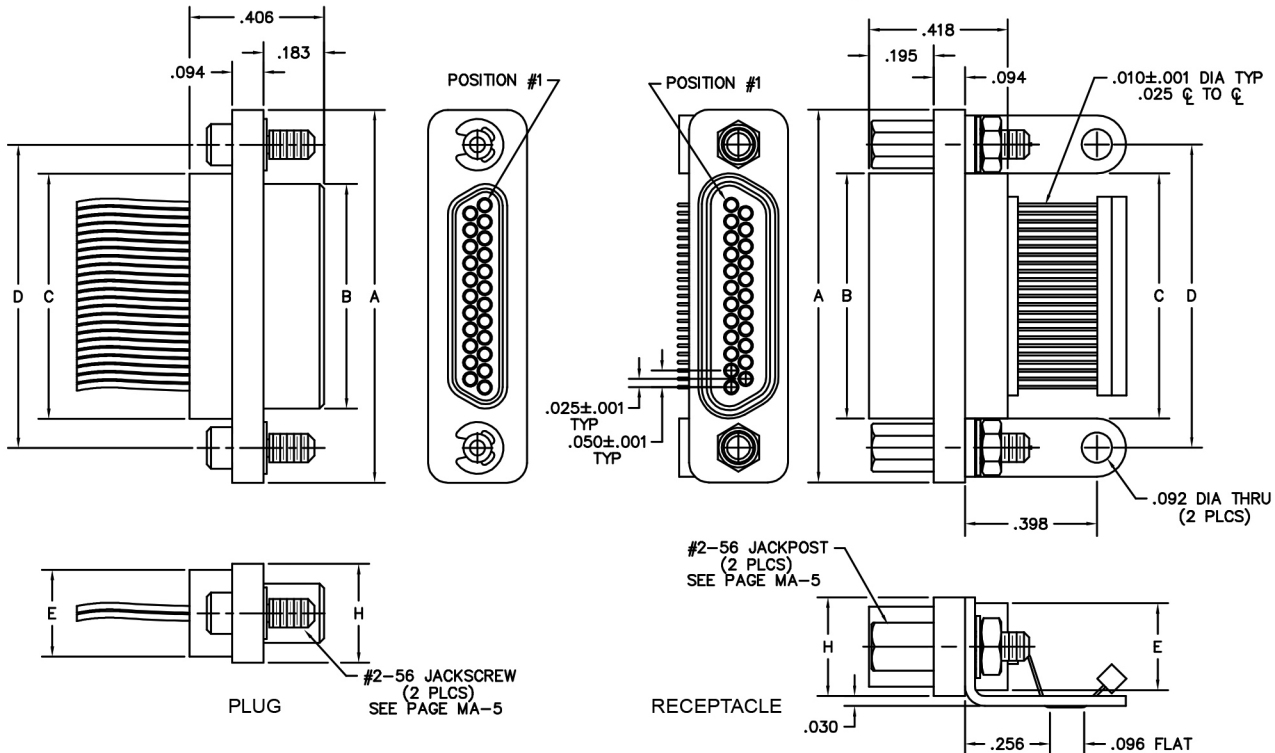

SIZE	CONTACT ROWS	DIMENSIONS					E	H	HARDWARE
		A	PLUG MAX	RCPT MAX	C	D			
9	2	.775	.334	.400	.390	.565	.270	.298	#2-56 UNC THD (.092 DIA THRU)
15		.925	.484	.550	.540	.715			
21		1.075	.634	.700	.690	.865			
25		1.175	.734	.800	.790	.965			
31		1.325	.884	.950	.940	1.115			
37		1.475	1.034	1.100	1.090	1.265			
51*		1.825	1.384	1.450	1.440	1.615			

\* = 51 POSITION CONNECTORS ARE AVAILABLE IN METAL ONLY.



**PLUG:** MM-213-025-161-41WQ  
**RECEPTACLE:** MM-223-025-275-320S  
**PLUG:** MN-211-025-161-41WQ  
**RECEPTACLE:** MN-221-025-275-320S

PLUG		RECEPTACLE	
<b>SERIES</b>			
MM .050" Rugged Metal I/O Connector		MM .050" Rugged Metal PC Board Mount, SMT Connector	
MN .050" Rugged Plastic I/O Connector (MM & MN mate with MK, ML, MM, MN receptacles)		MN .050" Rugged Plastic PC Board Mount, SMT Connector (MM & MN mate with MK, ML, MM, MN plugs)	
<b>BODY</b>			
2	2-Row (Sizes 9 thru 51***)	2	2-Row (Sizes 9 thru 51***)
<b>BODY STYLE:</b>		<b>BODY STYLE:</b>	
1	Plug, straight, with ears	2	Receptacle, straight, with ears
<b>BODY MATERIAL:</b>		<b>BODY MATERIAL:</b>	
1	Polyphenylene Sulfide (MN only)	1	Polyphenylene Sulfide (MN only)
2	Polyphenylene Sulfide with electroless nickel shell	2	Polyphenylene Sulfide with electroless nickel shell
3	Polyphenylene Sulfide with electrodeposited cadmium shell <input type="checkbox"/>	3	Polyphenylene Sulfide with electrodeposited cadmium shell <input type="checkbox"/>
4	Polyphenylene Sulfide with hard anodized black shell	4	Polyphenylene Sulfide with hard anodized black shell
5	Polyphenylene Sulfide with stainless steel shell	5	Polyphenylene Sulfide with stainless steel shell
A	Pure Electro-Deposited Aluminum	A	Pure Electro-Deposited Aluminum
K	Zinc Nickel Plating	K	Zinc Nickel Plating
T	Nickel Polymer Plating	T	Nickel Polymer Plating
<b>SIZE</b>			
XXX	009, 015, 021, 025, 031, 037, 051***	XXX	009, 015, 021, 025, 031, 037, 051***
<b>CONTACTS</b>			
<b>TYPE CONTACTS/TERMINATIONS:</b>		<b>TYPE CONTACTS/TERMINATIONS:</b>	
11	Pin, straight, solder cup	27	Socket, Surface Mount
14	Pin, straight, .500" pigtails (.018 dia)		
15	Pin, straight, 1.000" pigtails (.018 dia)		
16	Pin, straight, crimped wire		
<b>PLATING OPTIONS:</b>		<b>PLATING OPTIONS:</b>	
1	50 μ" Au contacts (crimp wire)	5	50 μ" Au contacts; Sn/Pb alloy terminations <input type="checkbox"/>
3	50 μ" Au contacts: 10 μ" Au terminations (solder cup, pigtail)	8	50 μ" Au contacts; Sn plated terminations
5	50 μ" Au contacts; Sn/Pb alloy terminations (pigtail) <input type="checkbox"/>		
7	50 μ" Au contacts; SAC305 terminations (pigtail)		
<b>HARDWARE</b>			
<b>STYLE OF HARDWARE:</b>		<b>STYLE OF HARDWARE:</b>	
00	None	00	None
22	Two fixed jacknut assemblies	32	Two fixed jacknut assemblies with mounting bracket
41	Two turning jackscrews, allen head, retaining ring	46	Two turning jackscrews, allen head, captivated** with mounting bracket
42	Two long turning jackscrews, allen head, retaining ring		
43	Two turning jackscrews, slot head, retaining ring		
44	Two long turning jackscrews, slot head, retaining ring		
45	Two turning jackscrews, allen head, captivated**		
<b>POLARIZATION / WIRING:</b>		<b>POLARIZATION / WIRING:</b>	
00	None	0R	Reverse Body Polarization
XX	For wiring codes, see page MA-3 & MA-4	0S	Standard Body Polarization
<b>OPTIONS</b>			
	900	Interfacial sealing gasket	

\*\* = Captive hardware is factory installed and non-removable.  
 \*\*\* = 51 position connectors are available in metal only (non Mil-Spec interface).  
 = Option not RoHS compliant



# Board SMT to Cable

**.050"**

**9 thru 51 Contacts**

**Rugged Metal**

**MM**

**Rugged Plastic**

**MN**

MM-212-025-175-320S  
(METAL)

MN-211-025-175-320S  
(PLASTIC)

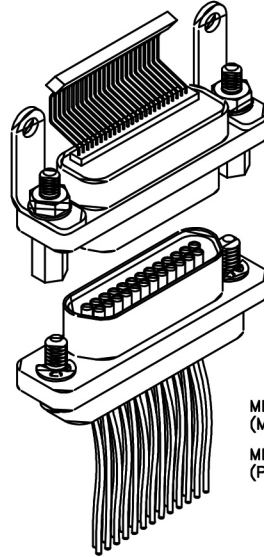

MM-222-025-261-41WQ  
(METAL)

MN-221-025-261-41WQ  
(PLASTIC)

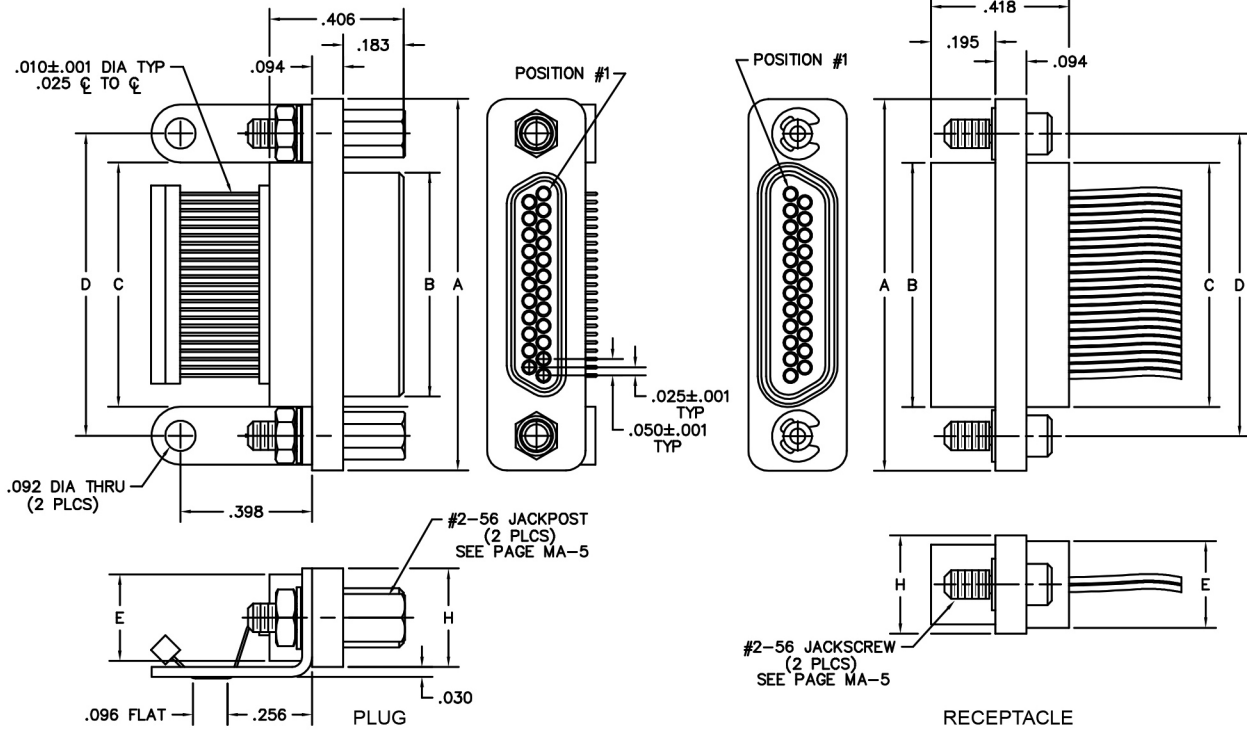

DIMENSIONS										
SIZE	CONTACT ROWS	B				C	D	E POTTING WELL MAX	H	HARDWARE
		A	PLUG MAX	RCPT MAX						
9	2	.775	.334	.400	.390	.565	.270	.298	#2-56 UNC THD (.092 DIA THRU)	
15		.925	.484	.550	.540	.715				
21		1.075	.634	.700	.690	.865				
25		1.175	.734	.800	.790	.965				
31		1.325	.884	.950	.940	1.115				
37		1.475	1.034	1.100	1.090	1.265				
51*		1.825	1.384	1.450	1.440	1.615				

\* = 51 POSITION CONNECTORS ARE AVAILABLE IN METAL ONLY.



**PLUG:** MM-212-025-175-320S  
**RECEPTACLE:** MM-222-025-261-41WQ  
**PLUG:** MN-211-025-175-320S  
**RECEPTACLE:** MN-221-025-261-41WQ  
 XX-XXX-XXX-XXX-XXXX-XXX

PLUG		RECEPTACLE	
<b>SERIES</b>			
MM .050" Rugged Metal PC Board Mount, SMT Connector	MM .050" Rugged Metal I/O Connector	MN .050" Rugged Plastic PC Board Mount, SMT Connector (MM & MN mate with MK, ML, MM, MN receptacles)	MN .050" Rugged Plastic I/O Connector (MM & MN mate with MK, ML, MM, MN plugs)
<b>BODY</b>			
2 2-Row (Sizes 9 thru 51***)	2 2-Row (Sizes 9 thru 51***)	BODY STYLE:	
1 Plug, straight, with ears	2 Receptacle, straight, with ears	BODY MATERIAL:	
1 Polyphenylene Sulfide (MN only)	1 Polyphenylene Sulfide (MN only)	2 Polyphenylene Sulfide with electroless nickel shell	2 Polyphenylene Sulfide with electroless nickel shell
2 Polyphenylene Sulfide with electroless nickel shell	3 Polyphenylene Sulfide with electrodeposited cadmium shell <input checked="" type="checkbox"/>	3 Polyphenylene Sulfide with electrodeposited cadmium shell <input checked="" type="checkbox"/>	4 Polyphenylene Sulfide with hard anodized black shell
3 Polyphenylene Sulfide with electrodeposited cadmium shell <input checked="" type="checkbox"/>	4 Polyphenylene Sulfide with hard anodized black shell	5 Polyphenylene Sulfide with stainless steel shell	5 Polyphenylene Sulfide with stainless steel shell
4 Polyphenylene Sulfide with hard anodized black shell	A Pure Electro-Deposited Aluminum	A Pure Electro-Deposited Aluminum	K Zinc Nickel Plating
5 Polyphenylene Sulfide with stainless steel shell	K Zinc Nickel Plating	T Nickel Polymer Plating	T Nickel Polymer Plating
A Pure Electro-Deposited Aluminum	T Nickel Polymer Plating		
K Zinc Nickel Plating			
T Nickel Polymer Plating			
<b>SIZE</b>			
XXX 009, 015, 021, 025, 031, 037, 051***		XXX 009, 015, 021, 025, 031, 037, 051***	
<b>CONTACTS</b>			
TYPE CONTACTS/TERMINATIONS:		TYPE CONTACTS/TERMINATIONS:	
17 Pin, Surface Mount	21 Socket, straight, solder cup	24 Socket, straight, .500" pigtails (.018 dia)	25 Socket, straight, 1.000" pigtails (.018 dia)
	26 Socket, straight, crimped wire		
PLATING OPTIONS:		PLATING OPTIONS:	
5 50 μ" Au contacts; Sn/Pb alloy terminations <input checked="" type="checkbox"/>	1 50 μ" Au contacts (crimp wire)	3 50 μ" Au contacts; 10 μ" Au terminations (solder cup, pigtail)	5 50 μ" Au contacts; Sn/Pb alloy terminations (pigtail) <input checked="" type="checkbox"/>
8 50 μ" Au contacts; Sn plated terminations	7 50 μ" Au contacts; SAC305 terminations (pigtail)		
<b>HARDWARE</b>			
STYLE OF HARDWARE:		STYLE OF HARDWARE:	
00 None	00 None	22 Two fixed jacknut assemblies with mounting bracket	41 Two turning jackscrews, allen head, retaining ring
32 Two fixed jacknut assemblies with mounting bracket	42 Two long turning jackscrews, allen head, retaining ring	43 Two turning jackscrews, slot head, retaining ring	44 Two long turning jackscrews, slot head, retaining ring
46 Two turning jackscrews, allen head, captivated** with mounting bracket	45 Two turning jackscrews, allen head, captivated**		
POLARIZATION / WIRING:		POLARIZATION / WIRING	
0R Reverse Body Polarization	00 None	XX For wiring codes, see page MA-3 & MA-4	
0S Standard Body Polarization			
<b>OPTIONS</b>			
900 Interfacial sealing gasket			

\*\* = Captive hardware is factory installed and non-removable.  
 \*\*\* = 51 position connectors are available in metal only (non Mil-Spec interface).  
 = Option not RoHS compliant



# Recommended PC Board Layout

Surface Mount  
Standard Polarization

**PLUG**  
PC BOARD LAYOUT  
COMPONENT SIDE

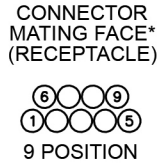
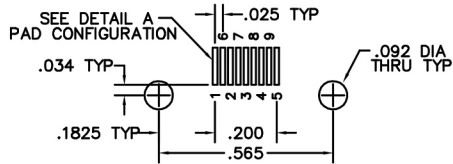
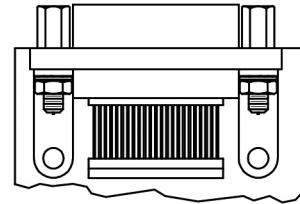
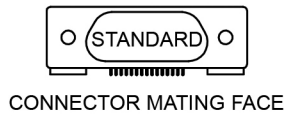

RECEPTACLE  
PC BOARD LAYOUT  
COMPONENT SIDE

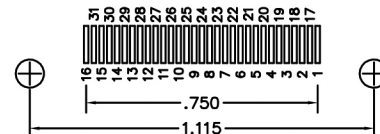
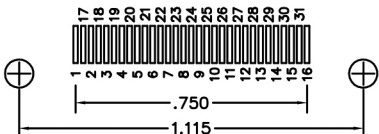
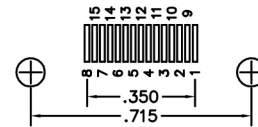
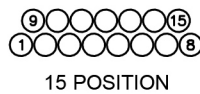
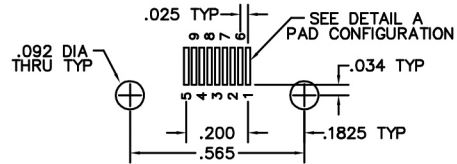

\* For pin (plug) connectors, the contact numbers are reversed left to right.

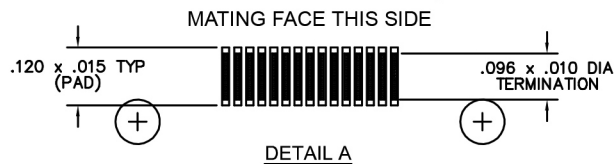

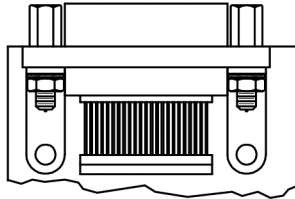
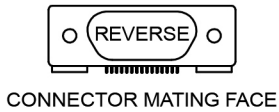

## Recommended PC Board Layout

Surface Mount  
Reverse Polarization

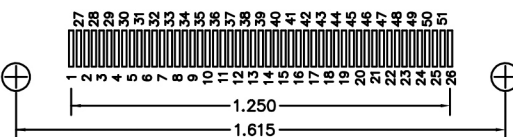
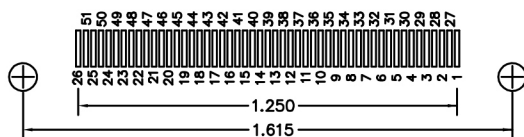
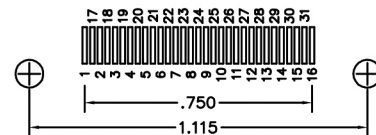
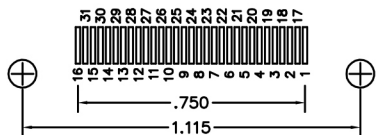
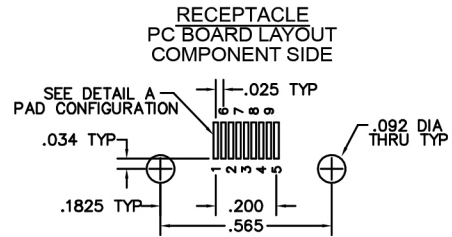
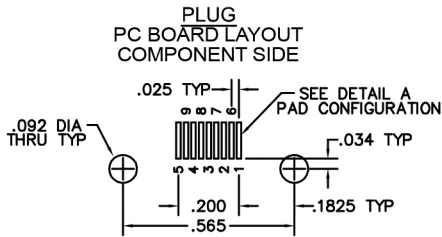

\* For pin (plug) connectors, the contact numbers are reversed left to right.





# Cable to Board (Vertical Surface Mount)

**.050"**

**9 thru 51 Contacts**

**Rugged Surface Mount**

**MK**

**Rugged Cable**

**MM**

MM-212-031-161-22WQ  
(METAL)

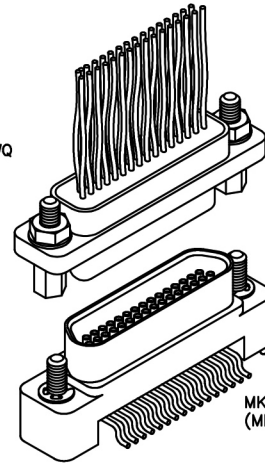

MK-2J2-031-475-4100  
(METAL)

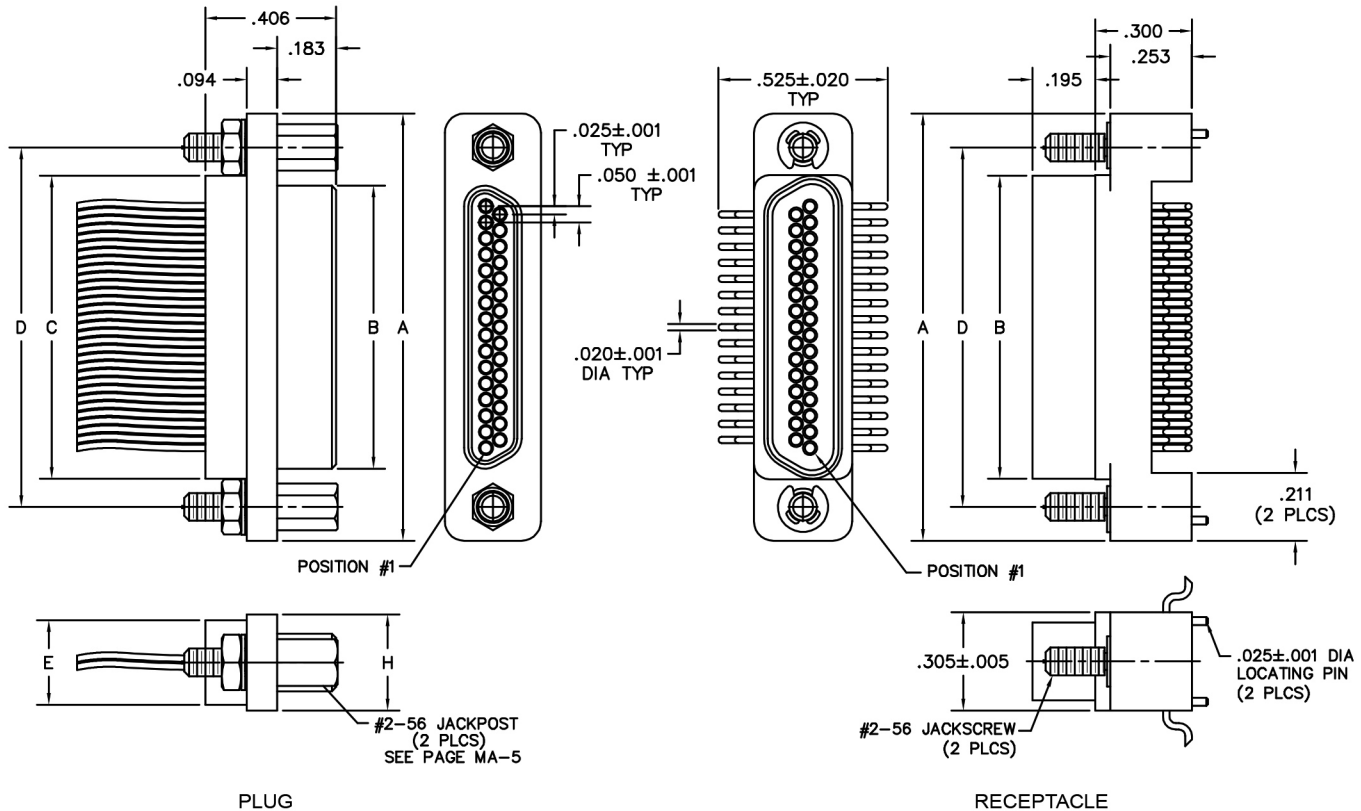

SIZE	CONTACT ROWS	DIMENSIONS							
		A	B		C	D	E	H	HARDWARE
			PLUG MAX	RCPT MAX					
9	2	.775	.334	.400	.390	.565	.270	.298	#2-56 UNC THD (.092 DIA THRU)
15		.925	.484	.550	.540	.715			
21		1.075	.634	.700	.690	.865			
25		1.175	.734	.800	.790	.965			
31		1.325	.884	.950	.940	1.115			
37		1.475	1.034	1.100	1.090	1.265			
51*		1.825	1.384	1.450	1.440	1.615			

\* = 51 POSITION CONNECTORS ARE NON-MIL SPEC INTERFACE



PLUG: MM-212-031-161-41WQ  
 RECEPTACLE: MK-2J2-031-475-2200  
 XX-XXX-XXX-XXX-XXXX-XXX

**PLUG**

**RECEPTACLE**

<b>SERIES</b>	
MM .050" Rugged Metal I/O Connector (MM mates with MK, ML, MM, MN receptacles)	MK .050" Rugged Metal Surface Mount Connector (MK mates with MK, ML, MM, MN plugs)
<b>BODY</b>	
2 2-Row (Sizes 9 thru 51*)	2 2-Row (Sizes 9 thru 51*)
<b>BODY STYLE:</b> 1 Plug, straight, with ears	<b>BODY STYLE:</b> J Receptacle, vertical surface mount
<b>BODY MATERIAL:</b> 2 Polyphenylene Sulfide with electroless nickel shell 3 Polyphenylene Sulfide with electrodeposited cadmium shell <input checked="" type="checkbox"/> 4 Polyphenylene Sulfide with hard anodized black shell A Pure Electro-Deposited Aluminum K Zinc Nickel Plating T Nickel Polymer Plating	<b>BODY MATERIAL:</b> 2 Polyphenylene Sulfide with electroless nickel shell 3 Polyphenylene Sulfide with electrodeposited cadmium shell <input checked="" type="checkbox"/> 4 Polyphenylene Sulfide with hard anodized black shell A Pure Electro-Deposited Aluminum K Zinc Nickel Plating T Nickel Polymer Plating
<b>SIZE</b>	
XXX 009, 015, 021, 025, 031, 037, 051*	XXX 009, 015, 021, 025, 031, 037, 051*
<b>CONTACTS</b>	
<b>TYPE CONTACTS/TERMINATIONS:</b> 11 Pin, straight, solder cup 14 Pin, straight, .500" pigtails (.018 dia) 15 Pin, straight, 1.000" pigtails (.018 dia) 16 Pin, straight, crimped wire	<b>TYPE CONTACTS/TERMINATIONS:</b> 47 Socket, vertical smt
<b>PLATING OPTIONS:</b> 1 50 μ" Au contacts (crimp wire) 3 50 μ" Au contacts: 10 μ" Au terminations (solder cup, pigtail) 5 50 μ" Au contacts: Sn/Pb alloy terminations (pigtail) <input checked="" type="checkbox"/> 7 50 μ" Au contacts: SAC305 terminations (pigtail)	<b>PLATING OPTIONS:</b> 5 50 μ" Au contacts; Sn/Pb alloy terminations <input checked="" type="checkbox"/> 7 50 μ" Au contacts; SAC305 terminations
<b>HARDWARE</b>	
<b>STYLE OF HARDWARE:</b> 00 None 22 Two fixed jacknut assemblies 41 Two turning jackscrews, allen head, retaining ring 42 Two long turning jackscrews, allen head, retaining ring 43 Two turning jackscrews, slot head, retaining ring 44 Two long turning jackscrews, slot head, retaining ring 45 Two turning jackscrews, allen head, captivated** 99 Keying hardware, see options below	<b>STYLE OF HARDWARE:</b> 00 None 22 Two fixed jacknut assemblies 41 Two turning jackscrews, allen head, retaining ring 99 Keying hardware, see options below
<b>POLARIZATION / WIRING:</b> 00 None XX For wiring codes, see page MA-3 & MA-4	<b>POLARIZATION / WIRING:</b> 00 None
<b>OPTIONS</b>	
KSXX Two turning jackscrews. See page MA-6 for keying options	KPXX Two fixed jacknuts and interfacial sealing gasket. See page MA-6 for keying options 900 Interfacial sealing gasket

\* = 2 row, 51 position connectors are non-Mil Spec interface.  
 \*\* = Captive hardware is factory installed and non-removable.

= Option not RoHS compliant



# Cable to Board (Vertical Surface Mount)

**.050"**

**9 thru 51 Contacts**

**Rugged Surface Mount**

**MK**

**Rugged Cable**

**MM**

MM-222-031-261-41WQ  
(METAL)

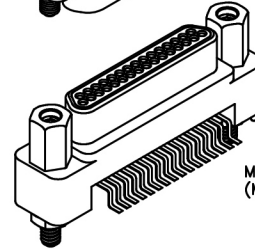
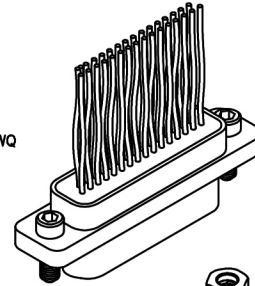

MK-2H2-031-375-2200  
(METAL)

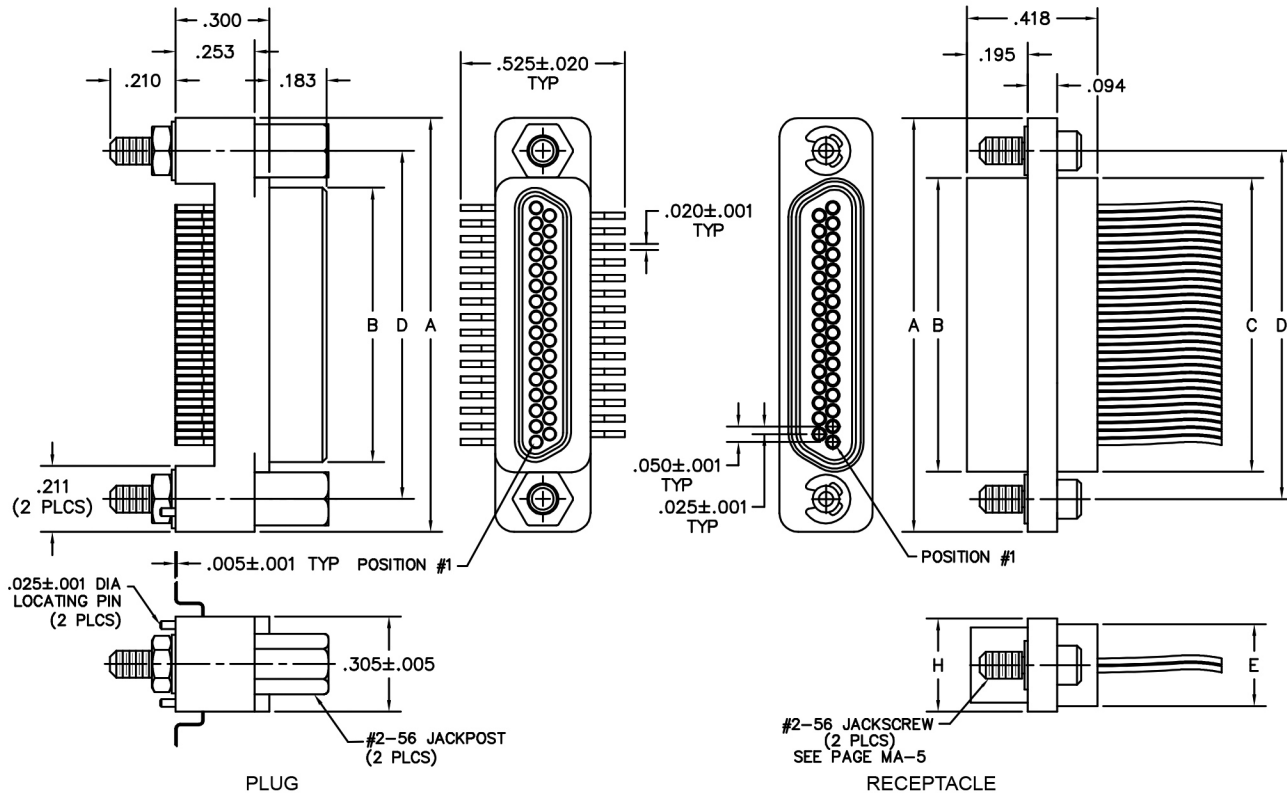

SIZE	CONTACT ROWS	DIMENSIONS						H	HARDWARE
		A	B		C	D	E		
			PLUG MAX	RCPT MAX			POTTING WELL MAX		
9	2	.775	.334	.400	.390	.565	.270	#2-56 UNC THD (.092 DIA THRU)	
15		.925	.484	.550	.540	.715			
21		1.075	.634	.700	.690	.865			
25		1.175	.734	.800	.790	.965			
31		1.325	.884	.950	.940	1.115			
37		1.475	1.034	1.100	1.090	1.265			
51*		1.825	1.384	1.450	1.440	1.615			

\* = 51 POSITION CONNECTORS ARE NON-MIL SPEC INTERFACE



PLUG: MK-2H3-031-375-2200  
 RECEPTACLE: MM-223-031-213-4100  
 XX-XXX-XXX-XXX-XXXX-XXX

**PLUG**

**RECEPTACLE**

<b>SERIES</b>	
MK .050" Rugged Metal Surface Mount Connector (MK mates with MK, ML, MM, MN receptacles)	MM .050" Rugged Metal I/O Connector (MM mates with MK, ML, MM, MN plugs)
<b>BODY</b>	
2 2-Row (Sizes 9 thru 51*)	2 2-Row (Sizes 9 thru 51*)
<b>BODY STYLE:</b> H Plug, vertical surface mount	<b>BODY STYLE:</b> 2 Receptacle, straight, with ears
<b>BODY MATERIAL:</b> 2 Polyphenylene Sulfide with electroless nickel shell 3 Polyphenylene Sulfide with electrodeposited cadmium shell <input checked="" type="checkbox"/> 4 Polyphenylene Sulfide with hard anodized black shell A Pure Electro-Deposited Aluminum K Zinc Nickel Plating T Nickel Polymer Plating	<b>BODY MATERIAL:</b> 2 Polyphenylene Sulfide with electroless nickel shell 3 Polyphenylene Sulfide with electrodeposited cadmium shell <input checked="" type="checkbox"/> 4 Polyphenylene Sulfide with hard anodized black shell A Pure Electro-Deposited Aluminum K Zinc Nickel Plating T Nickel Polymer Plating
<b>SIZE</b>	
XXX 009, 015, 021, 025, 031, 037, 051*	XXX 009, 015, 021, 025, 031, 037, 051*
<b>CONTACTS</b>	
<b>TYPE CONTACTS/TERMINATIONS:</b> 37 Pin, vertical smt	<b>TYPE CONTACTS/TERMINATIONS:</b> 21 Socket, straight, solder cup 24 Socket, straight, .500" pigtails (.018 dia) 25 Socket, straight, 1.000" pigtails (.018 dia) 26 Socket, straight, crimped wire
<b>PLATING OPTIONS:</b> 5 50 μ" Au contacts; Sn/Pb alloy terminations <input checked="" type="checkbox"/> 7 50 μ" Au contacts; SAC305 terminations	<b>PLATING OPTIONS:</b> 1 50 μ" Au contacts (crimp wire) 3 50 μ" Au contacts: 10 μ" Au terminations (solder cup, pigtail) 5 50 μ" Au contacts; Sn/Pb alloy terminations (pigtail) <input checked="" type="checkbox"/> 7 50 μ" Au contacts; SAC305 terminations (pigtail)
<b>HARDWARE</b>	
<b>STYLE OF HARDWARE:</b> 00 None 22 Two fixed jacknut assemblies 41 Two turning jackscrews, allen head, retaining ring 99 Keying hardware, see options below	<b>STYLE OF HARDWARE:</b> 00 None 22 Two fixed jacknut assemblies 41 Two turning jackscrews, allen head, retaining ring 42 Two long turning jackscrews, allen head, retaining ring 43 Two turning jackscrews, slot head, retaining ring 44 Two long turning jackscrews, slot head, retaining ring 45 Two turning jackscrews, allen head, captivated** 99 Keying hardware, see options below
<b>POLARIZATION / WIRING:</b> 00 None	<b>POLARIZATION / WIRING:</b> 00 None XX For wiring codes, see page MA-3 & MA-4
<b>OPTIONS</b>	
KPXX Two fixed jacknuts. See page MA-6 for keying options	KSXX Two turning jackscrews and interfacial sealing gasket. See page MA-6 for keying options 900 Interfacial sealing gasket

\* = 2 row, 51 position connectors are non-Mil Spec interface.  
 \*\* = Captive hardware is factory installed and non-removable.

= Option not RoHS compliant



# Recommended PC Board Layout

## Vertical Surface Mount

**PLUG**  
PC BOARD LAYOUT  
COMPONENT SIDE

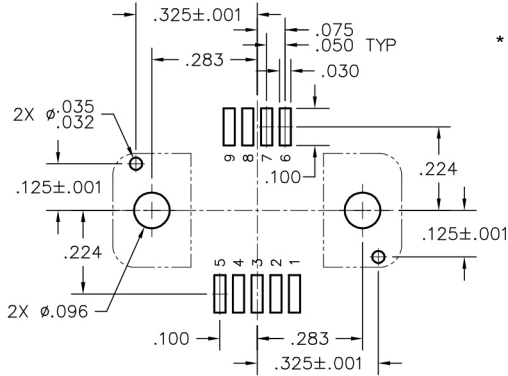

**CONNECTOR MATING FACE\* (RECEPTACLE)**

\* For pin (plug) connectors, the contact numbers are reversed left to right.



**RECEPTACLE**  
PC BOARD LAYOUT  
COMPONENT SIDE

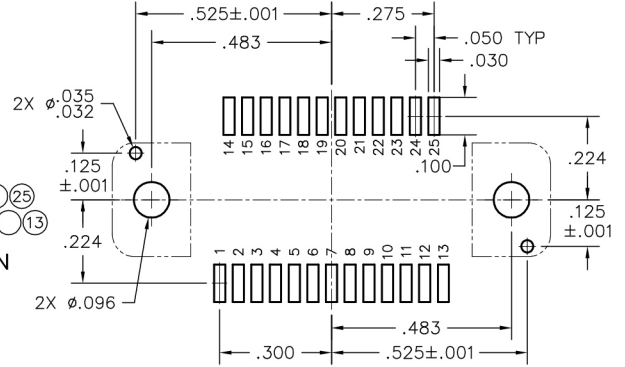
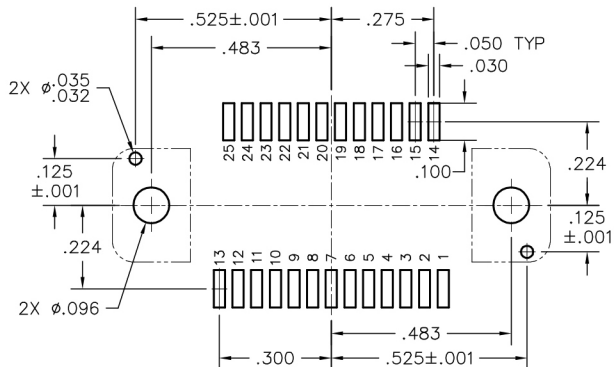
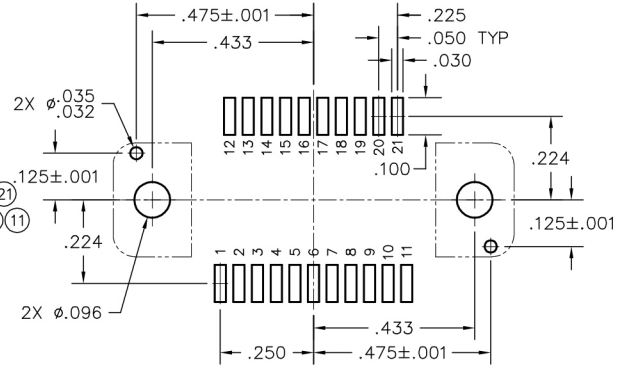
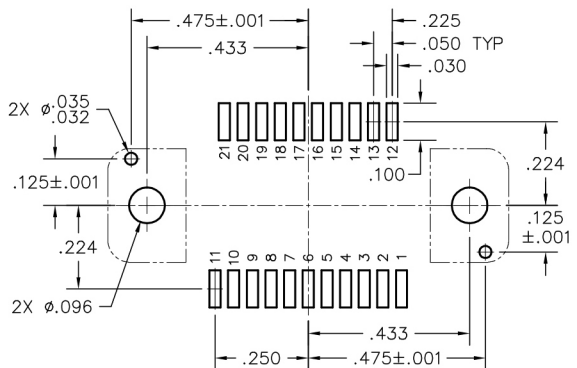
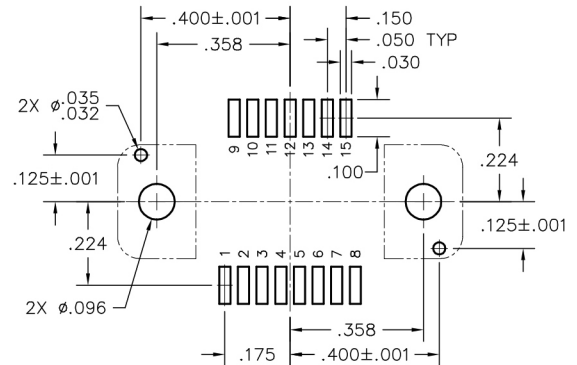
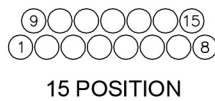
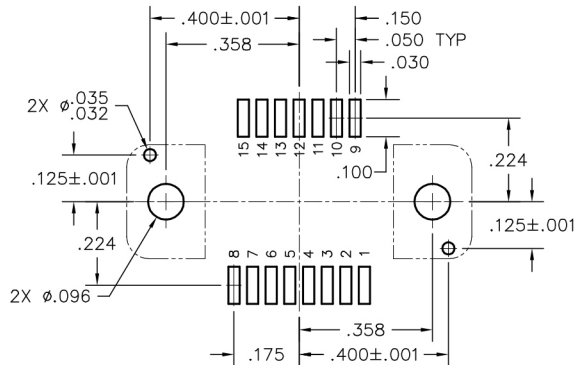
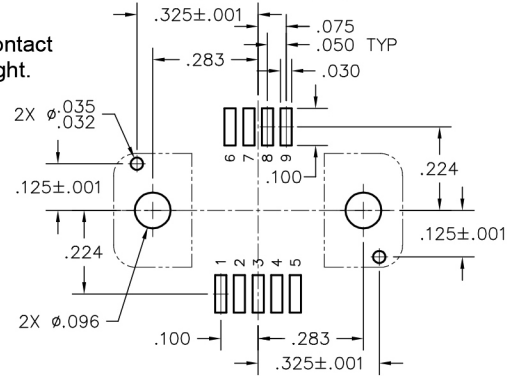

# Recommended PC Board Layout

## Vertical Surface Mount

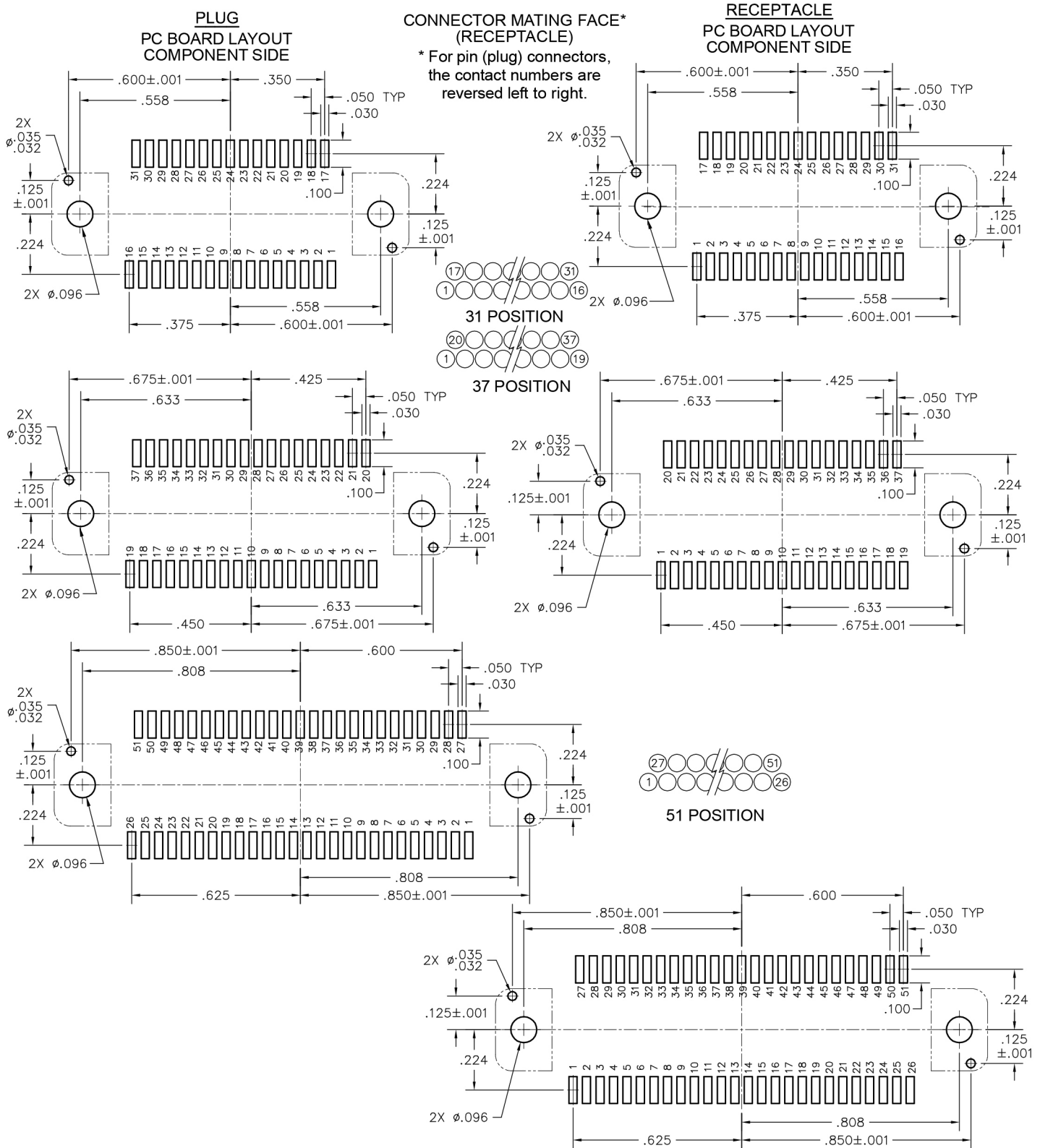



# Card Edge Mount to Cable

**.050"**

**9 thru 100 Contacts**

## Rugged Card Edge Mount

**MK**

**Rugged Metal**

**MM**

MK-2G2-037-275-460S  
(METAL)

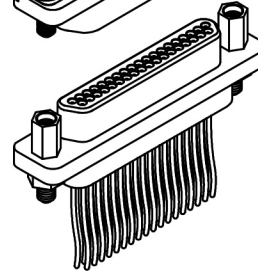
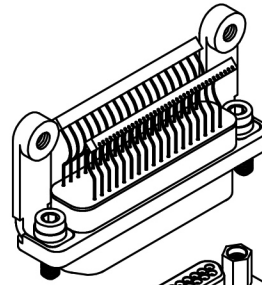

MM-212-037-161-22WQ  
(METAL)

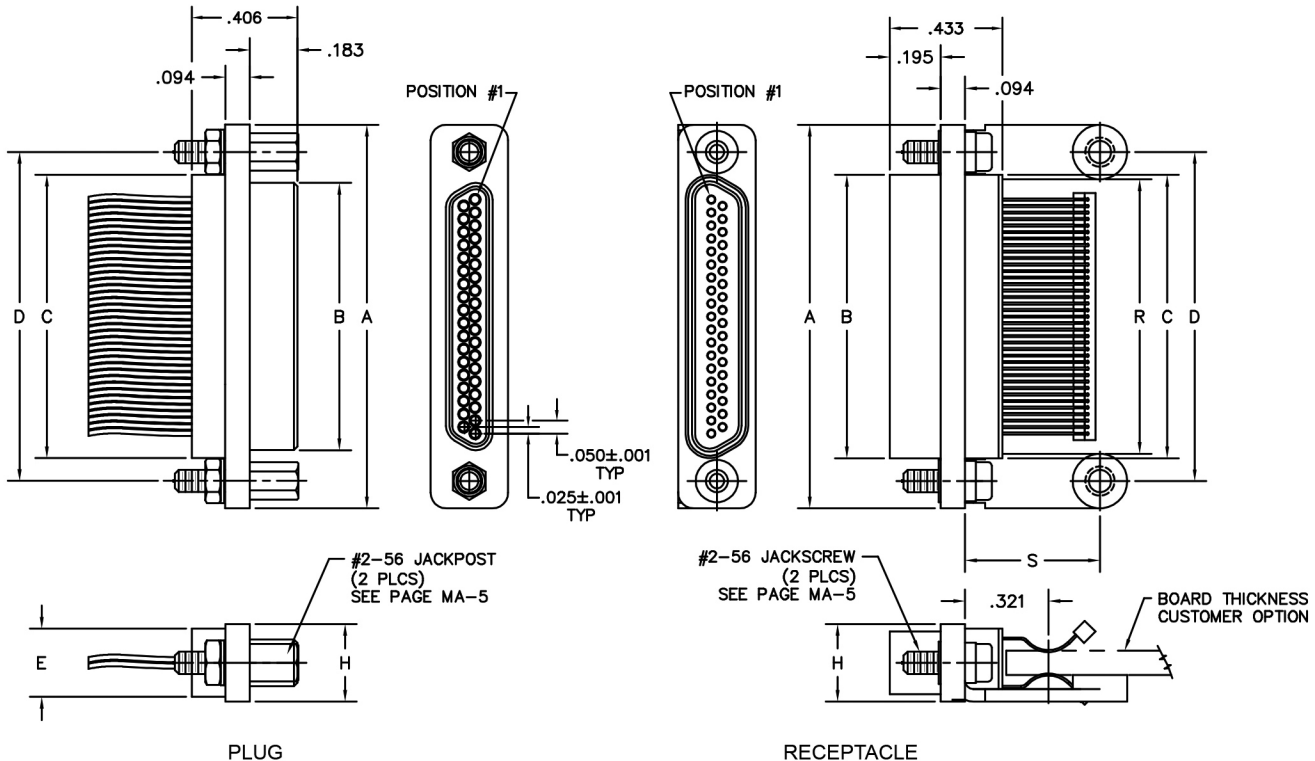

SIZE	CONTACT ROWS	DIMENSIONS										
		A	B		C	D	E	H	HARDWARE	MOUNTING HOLES	R	S
			PLUG MAX	RCPT MAX								
9	2	.775	.334	.400	.390	.565	.270	.298	#2-56 UNC THD	#4-40 UNC THD	.355	.519
15		.925	.484	.550	.540	.715						
21		1.075	.634	.700	.690	.865						
25		1.175	.734	.800	.790	.965						
31		1.325	.884	.950	.940	1.115						
37		1.475	1.034	1.100	1.090	1.265						
51	3	1.425	.984	1.050	1.040	1.215	.310	.341	#4-40 UNC THD	1.005	1.309	
69		1.725	1.284	1.350	1.340	1.515						
100		4	2.160	1.384	1.508	1.432						1.800



PLUG: MM-212-031-161-22WQ  
 RECEPTACLE: MK-2G2-031-275-460S-900  
 XX-XXX-XXX-XXX-XXXX-XXX

**PLUG**

**RECEPTACLE**

SERIES	
MM .050" Rugged Metal I/O Connector (MM mates with MK, ML, MM, MN receptacles)	MK .050" Rugged Metal Card Edge Mount (MK mates with MK, ML, MM, MN plugs)
BODY	
2 2-Row (Sizes 9 thru 37)	2 2-Row (Sizes 9 thru 37)
3 3-Row (Size 51 & 69)	3 3-Row (Size 51 & 69)
4 4-Row (Size 100)	4 4-Row (Size 100)
BODY STYLE: 1 Plug, straight, with ears	BODY STYLE: G Receptacle, straight, card edge with mounting brackets
BODY MATERIAL: 2 Polyphenylene Sulfide with electroless nickel shell	BODY MATERIAL: 2 Polyphenylene Sulfide with electroless nickel shell
3 Polyphenylene Sulfide with electrodeposited cadmium shell <input checked="" type="checkbox"/>	3 Polyphenylene Sulfide with electrodeposited cadmium shell <input checked="" type="checkbox"/>
4 Polyphenylene Sulfide with hard anodized black shell	4 Polyphenylene Sulfide with hard anodized black shell
A Pure Electro-Deposited Aluminum	A Pure Electro-Deposited Aluminum
K Zinc Nickel Plating	K Zinc Nickel Plating
T Nickel Polymer Plating	T Nickel Polymer Plating
SIZE	
XXX 009, 015, 021, 025, 031, 037, 051, 069, 100	XXX 009, 015, 021, 025, 031, 037, 051, 069, 100
CONTACTS	
TYPE CONTACTS/TERMINATIONS: 11 Pin, straight, solder cup	TYPE CONTACTS/TERMINATIONS: 27 Socket, surface mount, .062-.094" pcb thickness (.010 dia)
14 Pin, straight, .500" pigtails (.018 dia)	28 Socket, surface mount, .109-.140" pcb thickness (.010 dia)
15 Pin, straight, 1.000" pigtails (.018 dia)	
16 Pin, straight, crimped wire	
PLATING OPTIONS: 1 50 μ" Au contacts (crimp wire)	PLATING OPTIONS: 5 50 μ" Au contacts; Sn/Pb alloy terminations <input checked="" type="checkbox"/>
3 50 μ" Au contacts: 10 μ" Au terminations (solder cup, pigtail)	8 50 μ" Au contacts; Sn plated terminations
5 50 μ" Au contacts; Sn/Pb alloy terminations (pigtail) <input checked="" type="checkbox"/>	
7 50 μ" Au contacts; SAC305 terminations (pigtail)	
HARDWARE	
STYLE OF HARDWARE: 00 None	STYLE OF HARDWARE: 32 Two fixed jacknut assemblies (72*)
22 Two fixed jacknut assemblies (62*)	46 Two turning jackscrews, allen head, captivated** (86*)
41 Two turning jackscrews, allen head, retaining ring (81*)	
42 Two long turning jackscrews, allen head, retaining ring (82*)	
43 Two turning jackscrews, slot head, retaining ring (83*)	
44 Two long turning jackscrews, slot head, retaining ring (84*)	
45 Two turning jackscrews, allen head, captivated** (85*)	
POLARIZATION / WIRING: 00 None	POLARIZATION / WIRING 0S Standard Body Polarization
XX For wiring codes, see page MA-3 & MA-4	
OPTIONS	
	900 Interfacial sealing gasket

\* = Use number in parenthesis when ordering size 100.  
 \*\* = Captive hardware is factory installed and non-removable.  
 = Option not RoHS compliant



# Card Edge Mount to Cable

**.050"**

**9 thru 100 Contacts**

## Rugged Card Edge Mount

**MK**

**Rugged Metal**

**MM**

MK-2F2-037-175-320S  
(METAL)

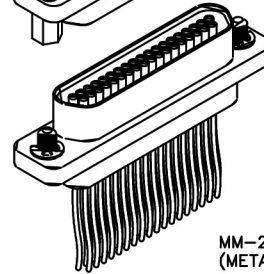
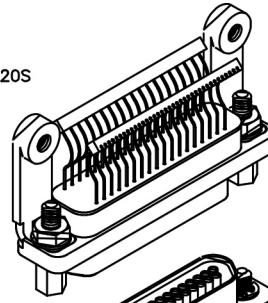

MM-222-037-261-41WQ  
(METAL)

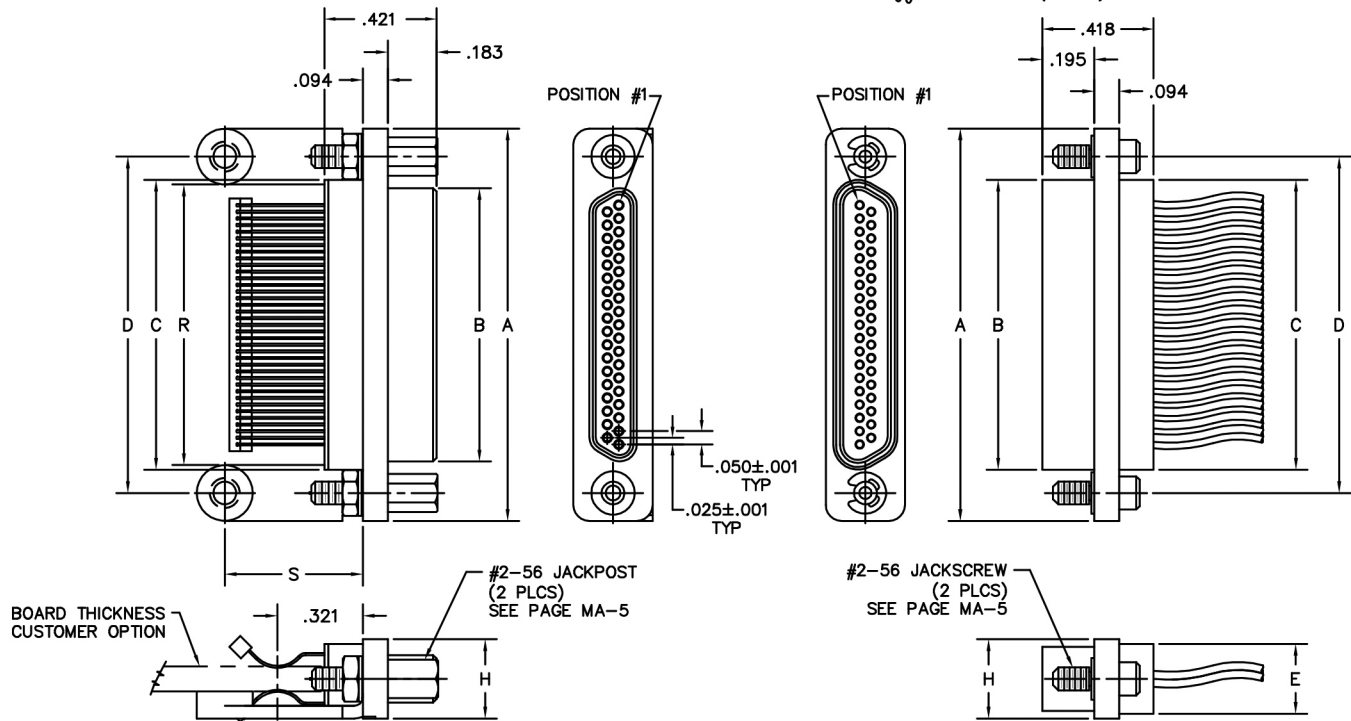

PLUG

RECEPTACLE

SIZE	CONTACT ROWS	DIMENSIONS										
		A	B		C	D	E	H	HARDWARE	MOUNTING HOLES	R	S
			PLUG MAX	RCPT MAX								
9	2	.775	.334	.400	.390	.565	.270	.298	#2-56 UNC THD	#4-40 UNC THD	.355	.519
15		.925	.484	.550	.540	.715						
21		1.075	.634	.700	.690	.865						
25		1.175	.734	.800	.790	.965						
31		1.325	.884	.950	.940	1.115						
37		1.475	1.034	1.100	1.090	1.265						
51	3	1.425	.984	1.050	1.040	1.215	.310	.341	#4-40 UNC THD	1.005	1.309	
69		1.725	1.284	1.350	1.340	1.515						
100		4	2.160	1.384	1.508	1.432						1.800



PLUG: MK-2F2-031-175-320S  
 RECEPTACLE: MM-222-031-261-41WQ-900  
 XX-XXX-XXX-XXX-XXXX-XXX

**PLUG**

**RECEPTACLE**

SERIES	
MK .050" Rugged Metal Card Edge Mount Connector (MK mates with MK, ML, MM, MN receptacles)	MM .050" Rugged Metal I/O Connector (MM mates with MK, ML, MM, MN plugs)
BODY	
2 2-Row (Sizes 9 thru 37)	2 2-Row (Sizes 9 thru 37)
3 3-Row (Size 51 & 69)	3 3-Row (Size 51 & 69)
4 4-Row (Size 100)	4 4-Row (Size 100)
BODY STYLE: F Plug, straight, card edge, with mounting brackets	BODY STYLE: 2 Receptacle, straight, with ears
BODY MATERIAL: 2 Polyphenylene Sulfide with electroless nickel shell	BODY MATERIAL: 2 Polyphenylene Sulfide with electroless nickel shell
3 Polyphenylene Sulfide with electrodeposited cadmium shell <input checked="" type="checkbox"/>	3 Polyphenylene Sulfide with electrodeposited cadmium shell <input checked="" type="checkbox"/>
4 Polyphenylene Sulfide with hard anodized black shell	4 Polyphenylene Sulfide with hard anodized black shell
A Pure Electro-Deposited Aluminum	A Pure Electro-Deposited Aluminum
K Zinc Nickel Plating	K Zinc Nickel Plating
T Nickel Polymer Plating	T Nickel Polymer Plating
SIZE	
XXX 009, 015, 021, 025, 031, 037, 051, 069, 100	XXX 009, 015, 021, 025, 031, 037, 051, 069, 100
CONTACTS	
TYPE CONTACTS/TERMINATIONS: 17 Pin, surface mount, .062-.094 pcb thickness (.010 dia)	TYPE CONTACTS/TERMINATIONS: 21 Socket, straight, solder cup
18 Pin, surface mount, .109-.140 pcb thickness (.010 dia)	24 Socket, straight, .500" pigtails (.018 dia)
PLATING OPTIONS: 5 50 μ" Au contacts; Sn/Pb alloy terminations <input checked="" type="checkbox"/>	25 Socket, straight, 1.000" pigtails (.018 dia)
8 50 μ" Au contacts; Sn plated terminations	26 Socket, straight, crimped wire
PLATING OPTIONS: 1 50 μ" Au contacts (crimp wire)	3 50 μ" Au contacts: 10 μ" Au terminations (solder cup, pigtail)
	5 50 μ" Au contacts; Sn/Pb alloy terminations (pigtail) <input checked="" type="checkbox"/>
	7 50 μ" Au contacts; SAC305 terminations (pigtail)
HARDWARE	
STYLE OF HARDWARE: 32 Two fixed jacknut assemblies (72*)	STYLE OF HARDWARE: 00 None
46 Two turning jackscrews, allen head, captivated** (86*)	22 Two fixed jacknut assemblies (62*)
	41 Two turning jackscrews, allen head, retaining ring (81*)
	42 Two long turning jackscrews, allen head, retaining ring (82*)
	43 Two turning jackscrews, slot head, retaining ring (83*)
	44 Two long turning jackscrews, slot head, retaining ring (84*)
	45 Two turning jackscrews, allen head, captivated** (85*)
POLARIZATION / WIRING: 0S Standard Body Polarization	POLARIZATION / WIRING 00 None
	XX For wiring codes, see page MA-3 & MA-4
OPTIONS	
	900 Interfacial sealing gasket

\* = Use number in parenthesis when ordering size 100.  
 \*\* = Captive hardware is factory installed and non-removable.

= Option not RoHS compliant



# Recommended PC Board Layout

Card Edge Mount  
Standard Polarization

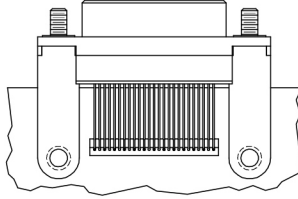

PC BOARD LAYOUT  
CIRCUIT SIDE

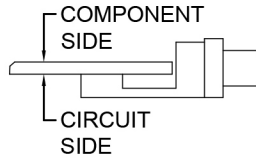

CONNECTOR MATING FACE

PLUG  
PC BOARD LAYOUT  
COMPONENT SIDE

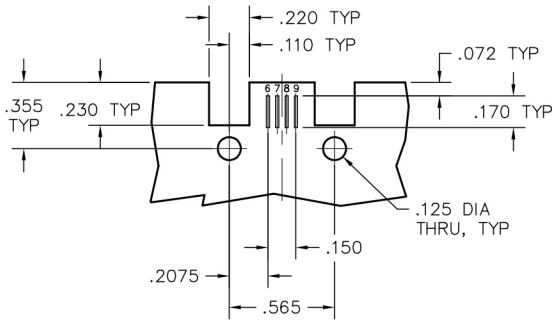

CONNECTOR  
MATING FACE



9 POSITION

PLUG  
PC BOARD LAYOUT  
CIRCUIT SIDE

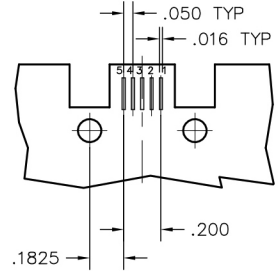

15 POSITION

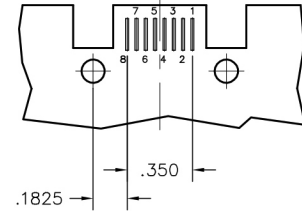
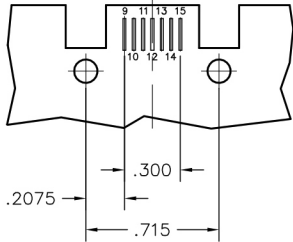

21 POSITION

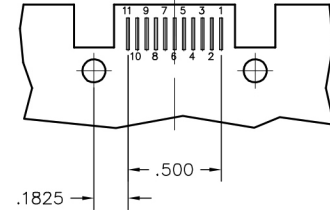
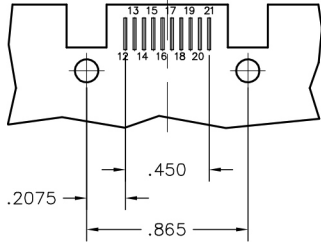

25 POSITION

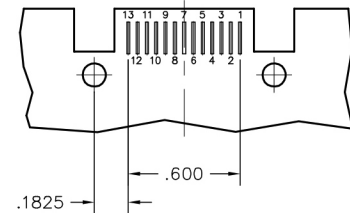
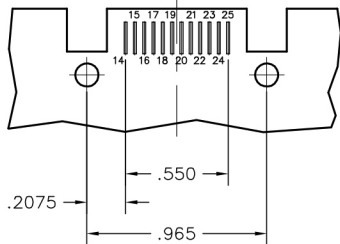

31 POSITION

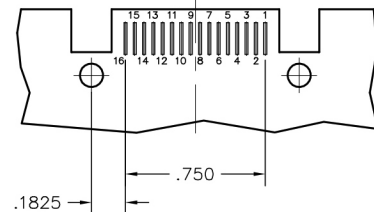
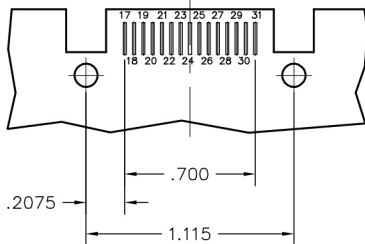

## Recommended PC Board Layout

Card Edge Mount  
Standard Polarization

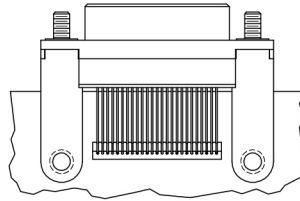
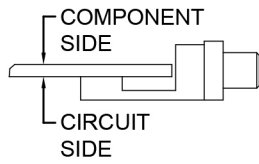

PLUG  
PC BOARD LAYOUT  
COMPONENT SIDE

PLUG  
PC BOARD LAYOUT  
CIRCUIT SIDE

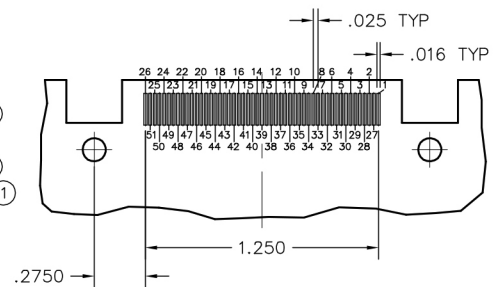
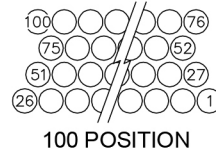
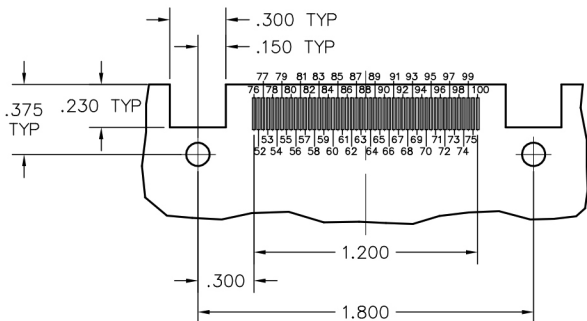
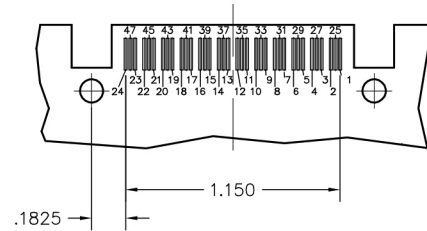
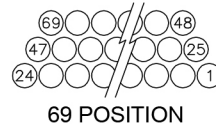
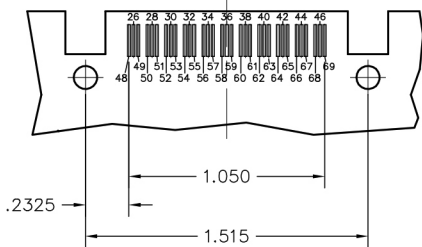
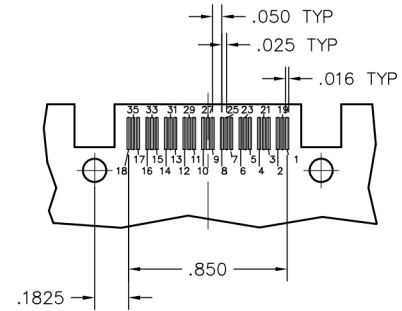
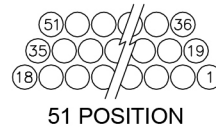
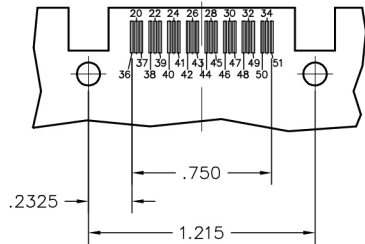
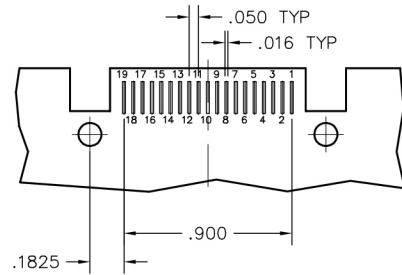
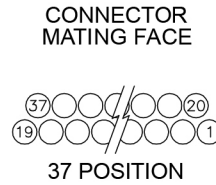
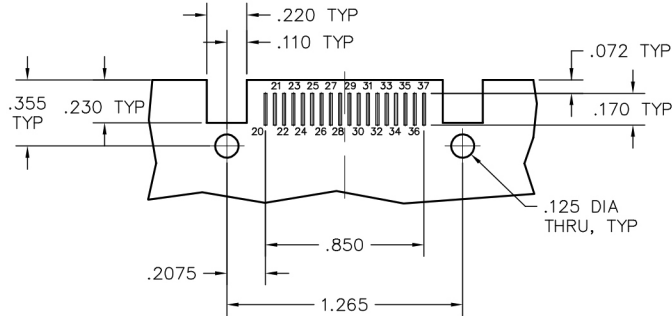



# Recommended PC Board Layout

Card Edge Mount  
Standard Polarization

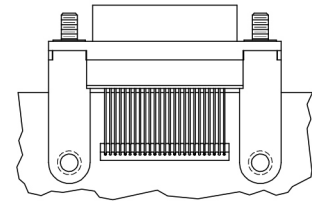
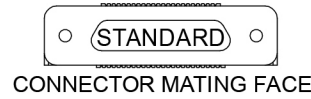
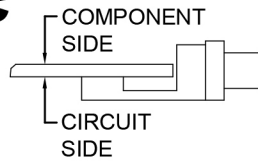

PC BOARD LAYOUT  
CIRCUIT SIDE  
RECEPTACLE  
PC BOARD LAYOUT  
CIRCUIT SIDE

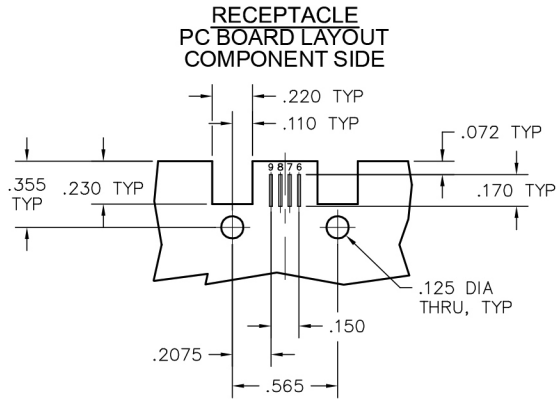

CONNECTOR  
MATING FACE

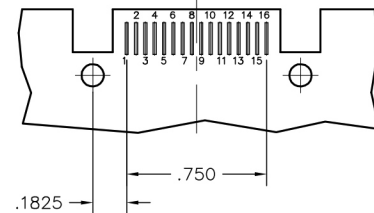
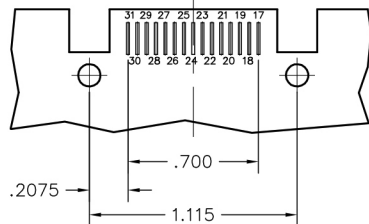
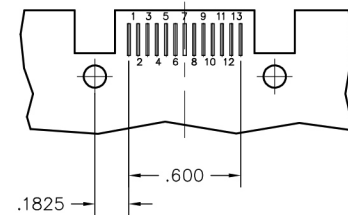
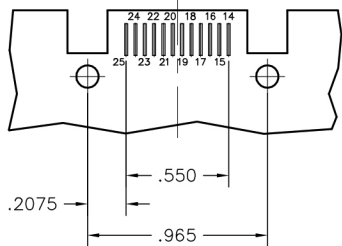
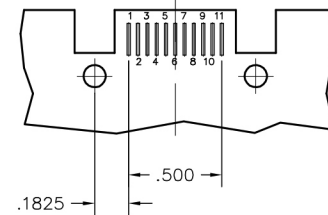
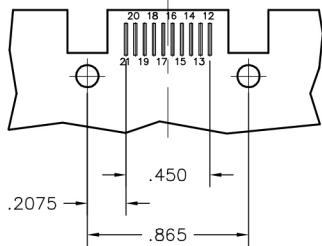
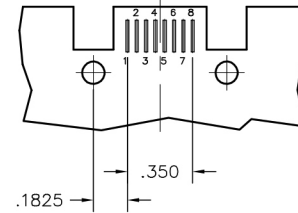
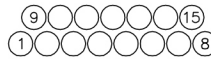
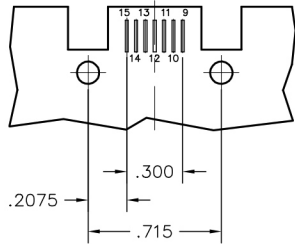
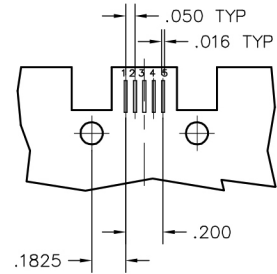

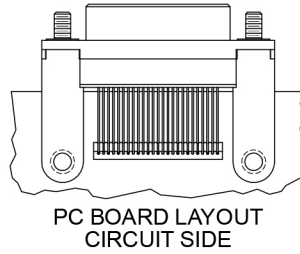
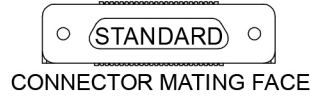
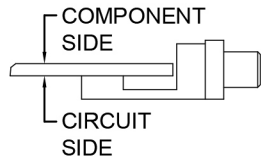

## Recommended PC Board Layout

Card Edge Mount  
Standard Polarization

RECEPTACLE  
PC BOARD LAYOUT  
COMPONENT SIDE

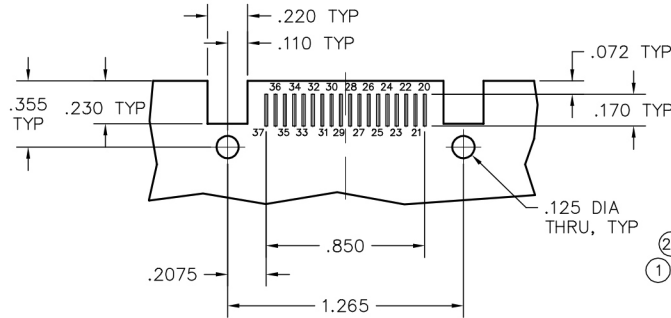

CONNECTOR  
MATING FACE



RECEPTACLE  
PC BOARD LAYOUT  
CIRCUIT SIDE

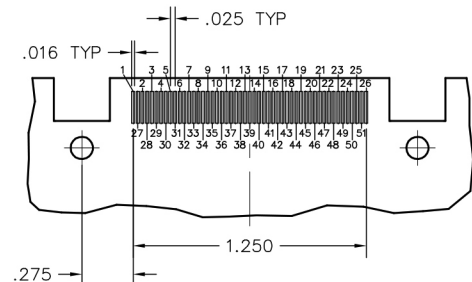
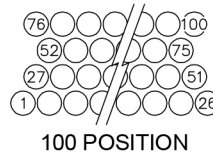
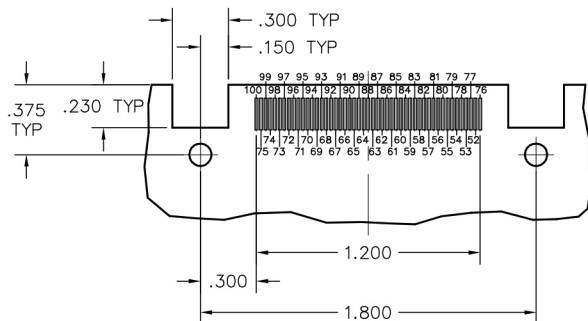
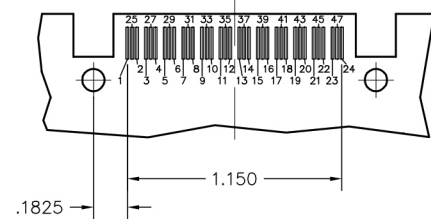
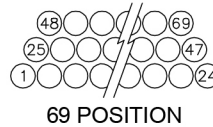
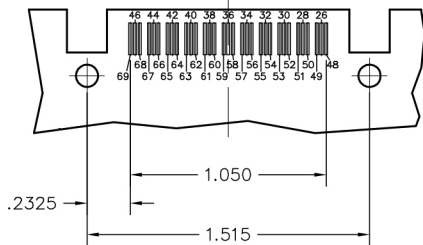
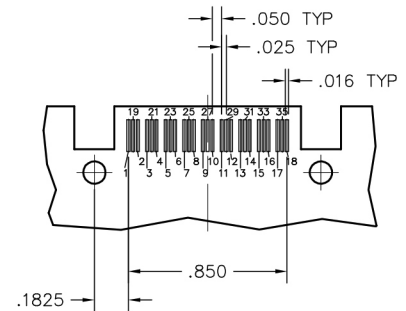
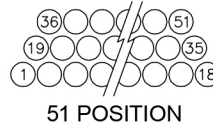
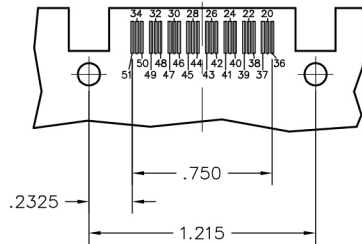
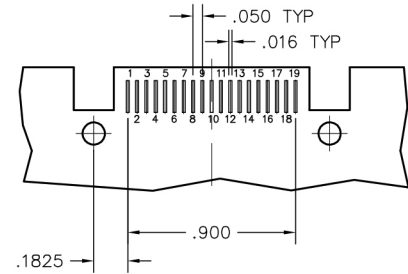



# Filtered Cable Connectors

**.050"**

**9 thru 37 Contacts**

**Rugged Metal**

**MF**

## Electrical Data

Dielectric Withstanding Voltage (DWV): 300 VDC  
 Insulation Resistance: 5000 Megohms @ 100 VDC  
 Working Voltage (WV): 100 VDC  
 Current Rating: 3 Amps

## Application Notes

1. Hipot voltage must not exceed working voltage.
2. Maximum solder tinning temperature is 275° C while maintaining a tinning dwell of 5 seconds max.
3. Maximum solder station temperature is 360° C while maintaining a soldering dwell of less than 5 seconds.
4. Temperature exceeding 150° C should never be applied to the entire connector. Failure to adhere to these guidelines may result in damage to connector or significantly reduced operating characteristics.

MF-222-015-261-22WS-CF3

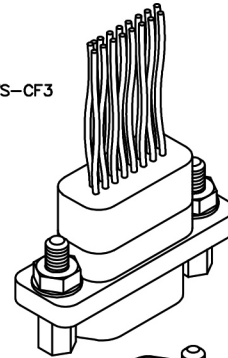

MF-212-015-145-4100-CF6

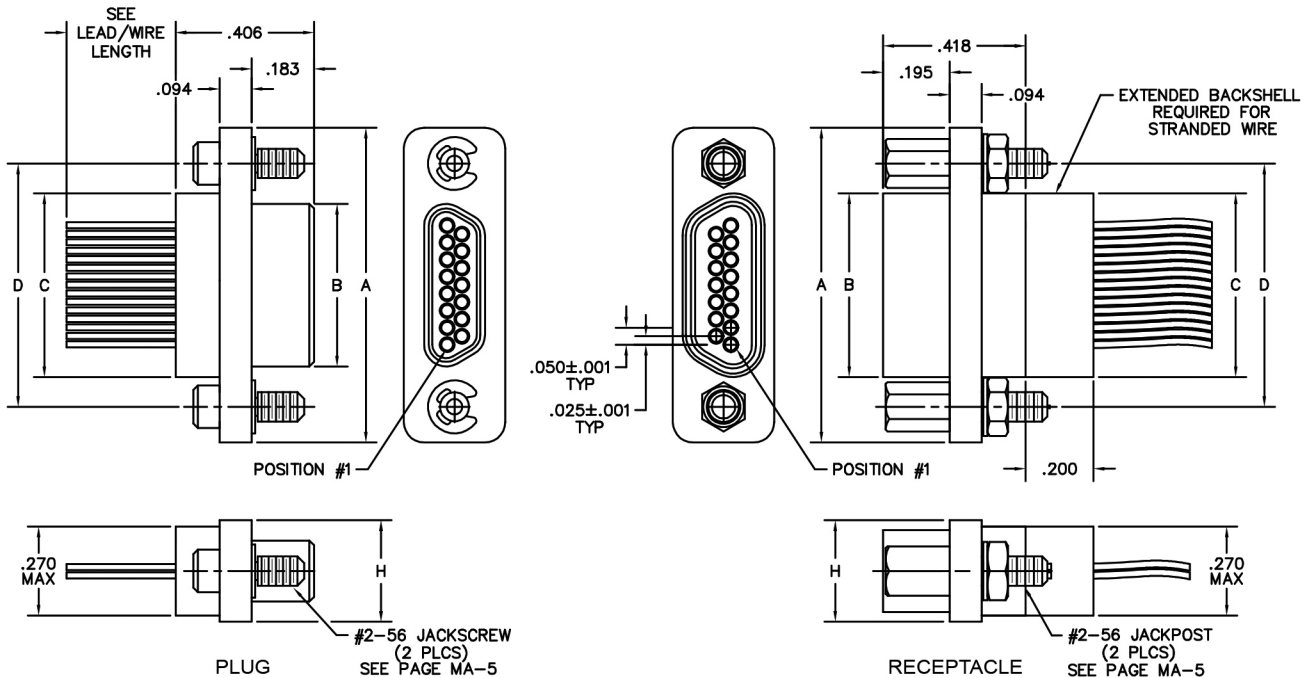
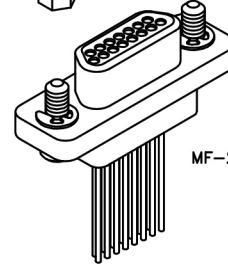

SIZE	CONTACT ROWS	DIMENSIONS					H	HARDWARE
		A	B		C	D		
			PLUG MAX	RCPT MAX				
9	2	.775	.334	.400	.390	.565	.298	#2-56 UNC THD (.092 DIA THRU)
15		.925	.484	.550	.540	.715		
21		1.075	.634	.700	.690	.865		
25		1.175	.734	.800	.790	.965		
31		1.325	.884	.950	.940	1.115		
37		1.475	1.034	1.100	1.090	1.265		



**PLUG:** MF-212-015-145-4100-CF6  
**RECEPTACLE:** MM-222-031-2G3-4500  
**PLUG:** MF-212-031-1G3-4500  
**RECEPTACLE:** MF-222-015-261-22WS-CF3  
 XX-XXX-XXX-XXX-XXXX-XXX

PLUG		RECEPTACLE	
<b>SERIES</b>			
MF .050" Rugged Metal I/O Connector (MF mates with MK, ML, MM, MN receptacles)		MF .050" Rugged Metal I/O Connector (MF mates with MK, ML, MM, MN plugs)	
<b>BODY</b>			
2 2-Row (Sizes 9 thru 37)		2 2-Row (Sizes 9 thru 37)	
BODY STYLE: 1 Plug, straight, with ears		BODY STYLE: 2 Receptacle, straight, with ears & interfacial seal	
BODY MATERIAL: 2 Polyphenylene Sulfide with electroless nickel shell		BODY MATERIAL: 2 Polyphenylene Sulfide with electroless nickel shell	
3 Polyphenylene Sulfide with electrodeposited cadmium shell <input checked="" type="checkbox"/>		3 Polyphenylene Sulfide with electrodeposited cadmium shell <input checked="" type="checkbox"/>	
<b>SIZE</b>			
XXX 009, 015, 021, 025, 031, 037		XXX 009, 015, 021, 025, 031, 037	
<b>CONTACTS</b>			
TYPE CONTACTS/TERMINATIONS:		TYPE CONTACTS/TERMINATIONS:	
1D Pin, straight, .109" Lead Length (.018 dia) SEE NOTE 1	2D Socket, straight, .109" Lead Length (.018 dia)	1E Pin, straight, .125" Lead Length (.018 dia) SEE NOTE 1	2E Socket, straight, .125" Lead Length (.018 dia)
1F Pin, straight, .140" Lead Length (.018 dia) SEE NOTE 1	2F Socket, straight, .140" Lead Length (.018 dia)	1G Pin, straight, .156" Lead Length (.018 dia) SEE NOTE 1	2G Socket, straight, .156" Lead Length (.018 dia)
12 Pin, straight, .150" Lead Length (.018 dia) SEE NOTE 1	22 Socket, straight, .150" Lead Length (.018 dia)	1H Pin, straight, .172" Lead Length (.018 dia) SEE NOTE 1	2H Socket, straight, .172" Lead Length (.018 dia)
1J Pin, straight, .187" Lead Length (.018 dia) SEE NOTE 1	2J Socket, straight, .187" Lead Length (.018 dia)	1K Pin, straight, .375" Lead Length (.018 dia) SEE NOTE 1	2K Socket, straight, .375" Lead Length (.018 dia)
13 Pin, straight, .250" Lead Length (.018 dia) SEE NOTE 1	23 Socket, straight, .250" Lead Length (.018 dia)	14 Pin, straight, .500" pigtails (.018 dia) SEE NOTE 1	2L Socket, straight, .500" Lead Length (.018 dia)
15 Pin, straight, .500" pigtails (.018 dia) SEE NOTE 1	2M Socket, straight, .500" Lead Length (.018 dia)	16 Pin, straight, 1.000" pigtails (.018 dia) SEE NOTE 1	24 Socket, straight, .500" pigtails (.018 dia) SEE NOTE 1
	25 Socket, straight, 1.000" pigtails (.018 dia) SEE NOTE 1		26 Socket, straight, 1.000" pigtails (.018 dia) SEE NOTE 1
PLATING OPTIONS:		PLATING OPTIONS:	
1 50 μ" Au contacts (stranded wire) <input checked="" type="checkbox"/>	1 50 μ" Au contacts (stranded wire) <input checked="" type="checkbox"/>	3 50 μ" Au contacts: 10 μ" Au terminations (pigtails)	3 50 μ" Au contacts: 10 μ" Au terminations (pigtails)
5 50 μ" Au contacts; Sn/Pb alloy terminations (pigtails) <input checked="" type="checkbox"/>	5 50 μ" Au contacts; Sn/Pb alloy terminations (pigtails) <input checked="" type="checkbox"/>		
<b>HARDWARE</b>			
STYLE OF HARDWARE:		STYLE OF HARDWARE:	
00 None	00 None	22 Two fixed jacknut assemblies	22 Two fixed jacknut assemblies
41 Two turning jackscrews, allen head, retaining ring	41 Two turning jackscrews, allen head, retaining ring	42 Two long turning jackscrews, allen head, retaining ring	42 Two long turning jackscrews, allen head, retaining ring
42 Two long turning jackscrews, allen head, retaining ring	42 Two long turning jackscrews, allen head, retaining ring	43 Two turning jackscrews, slot head, retaining ring	43 Two turning jackscrews, slot head, retaining ring
43 Two turning jackscrews, slot head, retaining ring	43 Two turning jackscrews, slot head, retaining ring	44 Two long turning jackscrews, slot head, retaining ring	44 Two long turning jackscrews, slot head, retaining ring
44 Two long turning jackscrews, slot head, retaining ring	44 Two long turning jackscrews, slot head, retaining ring	45 Two turning jackscrews, allen head, captivated**	45 Two turning jackscrews, allen head, captivated**
45 Two turning jackscrews, allen head, captivated**	45 Two turning jackscrews, allen head, captivated**		
WIRING:		WIRING:	
00 None	00 None	XX For wiring codes, see page MA-3 & MA-4	XX For wiring codes, see page MA-3 & MA-4
<b>CAPACITOR DESIGNATOR</b>			
XXX See tables below		XXX See tables below	

\*\* = Captive hardware is factory installed and non-removable. NOTE 1 = The leads on these contacts are soft copper suitable for forming.  
 = Option not RoHS compliant

**CERAMIC CHIP CAPACITOR FILTERS**

CAPACITOR DESIGNATOR	CAP RANGE (pF)	MINIMUM INSERTION LOSS (DECIBELS)			
		10 MHz	15 MHz	30 MHz	50 MHz
CF1 <input checked="" type="checkbox"/>	150-250	—	—	1	4
CF2 <input checked="" type="checkbox"/>	300-500	1	2	5	8
CF3 <input checked="" type="checkbox"/>	700-1000	3	5	10	10
CF4 <input checked="" type="checkbox"/>	1300-2000	6	10	15	20
CF5 <input checked="" type="checkbox"/>	4000-5400	13	15	20	27
CF6 <input checked="" type="checkbox"/>	8500-11500	18	20	25	30

**PLANAR CAPACITOR FILTERS**

CAPACITOR DESIGNATOR	CAP RANGE (pF)	MINIMUM INSERTION LOSS (DECIBELS)			
		10 MHz	100 MHz	500 MHz	1 GHz
PF1 <input checked="" type="checkbox"/>	150-250	—	8	33	36
PF2 <input checked="" type="checkbox"/>	300-500	—	13	37	44
PF3 <input checked="" type="checkbox"/>	700-1000	2	19	42	42
PF4 <input checked="" type="checkbox"/>	1300-2000	6	25	45	45
PF5 <input checked="" type="checkbox"/>	4000-5400	14	34	41	41
PF6 <input checked="" type="checkbox"/>	8500-11500	20	36	43	43

Minimum no load attenuation (in 50 Ohm system, 25° C)



## Specifications - Hybrid Connectors Materials and Finishes \*

<b>Contacts:</b>	Pins: BeCu alloy strip per ASTM B194 Sockets: Brass per ASTM B121 / B121M or ASTM B16 / B16M or ASTM B453 Power: Copper based alloy selected for power applications
<b>Contact Finish:</b>	Gold plate per ASTM B488
<b>Shells:</b>	Aluminum Alloy 6061-T6 per SAE AMS-QQ-A-250/11 or 6061-T6511 per SAE AMS-QQ-A-200/8
<b>Aluminum Shell Finishes:</b>	Electroless Nickel per SAE AMS2404, Class 3, 500 $\mu$ " min Electrodeposited Cadmium per SAE AMS-QQ-P-416, Type II, Class 3
<b>Molded Insulators:</b>	Glass filled polyphenylene sulfide per MIL-M-24519
<b>Embedment:</b>	Frey Engineering Co. insulating compound CF3003-80 and L-II-49 or equivalent
<b>Jackscrews, Jackposts and Nuts:</b>	Corrosion resistant steel per ASTM A320 or ASTM A484 / A484M and ASTM A582 / A582 Passivated per SAE AMS2700
<b>Clips and Washers:</b>	Corrosion resistant steel per ASME 18.24 or NASM35333 (For reference only: ASME 18.24 CRS per ASTM A693 and NASM35333 CRS per ASTM A240) Passivated per ASME 18.24 or NASM35333 (For reference only: ASME 18.24 and NASM35333 passivated per SAE AMS2700)
<b>Interfacial Seal Gaskets:</b>	Fluorosilicone per SAE AMS-R-25988
<b>Tolerances:</b>	Unless otherwise specified: Fractions = $\pm 1/64$ " Decimals = $\pm 0.010$ " Angles = $\pm 5^\circ$ Wire lengths: insulated/stranded = $+1.0"/-0.0$ "

Note: AirBorn can manufacture special configurations for your exact specifications.

\* = Reference the above listed specifications or an equivalent industry standard when applicable



## Performance - Hybrid Connectors Reference MIL-DTL-83513

<b>Contact Rating:</b>	3-amperes maximum for signal and coax contacts 13-amperes maximum for power contacts
<b>Solderability:</b>	Terminals (except crimp) tested in accordance with MIL-STD-202, Method 208
<b>Wire Size:</b>	Stranded #16 AWG standard for power contacts RG316 or RG178 standard for coax contacts Stranded #24-#28 AWG standard (consult factory for other sizes and types)
<b>Test Voltage:</b>	600 V, RMS, 60 Hz
<b>Operating Temperature:</b>	-55° C to +125° C
<b>Insulation Resistance:</b>	5,000 megohms minimum @ 500 VDC
<b>Durability:</b>	500 connector mating cycles
<b>Vibration:</b>	Tested in accordance with MIL-STD-1344, Method 2005, Condition IV, according to MIL-83513
<b>Shock:</b>	Tested in accordance with MIL-STD-1344, Method 2004, Condition E, according to MIL-83513
<b>Salt Spray:</b>	Mated connectors tested in accordance with MIL-STD-1344, Method 1001, Test Condition B
<b>Humidity:</b>	Mated connectors tested in accordance with MIL-STD-1344, Method 1002, Type II (except steps 7a and 7b)
<b>Thermal Shock:</b>	Tested to the temperature extremes of MIL-STD-1344, Method 1003, Test Condition A (except step 3, temperature shall be 125° C)



# Cable to Cable Hybrid

**.050"**

**7 or 24 Contacts**

**Rugged Metal**

**MM**

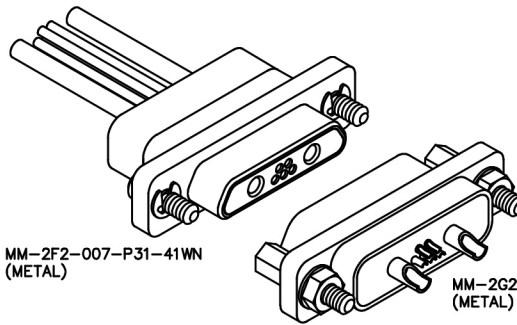

MM-2F2-007-P31-41WN  
(METAL)

MM-2G2-007-P23-2200  
(METAL)

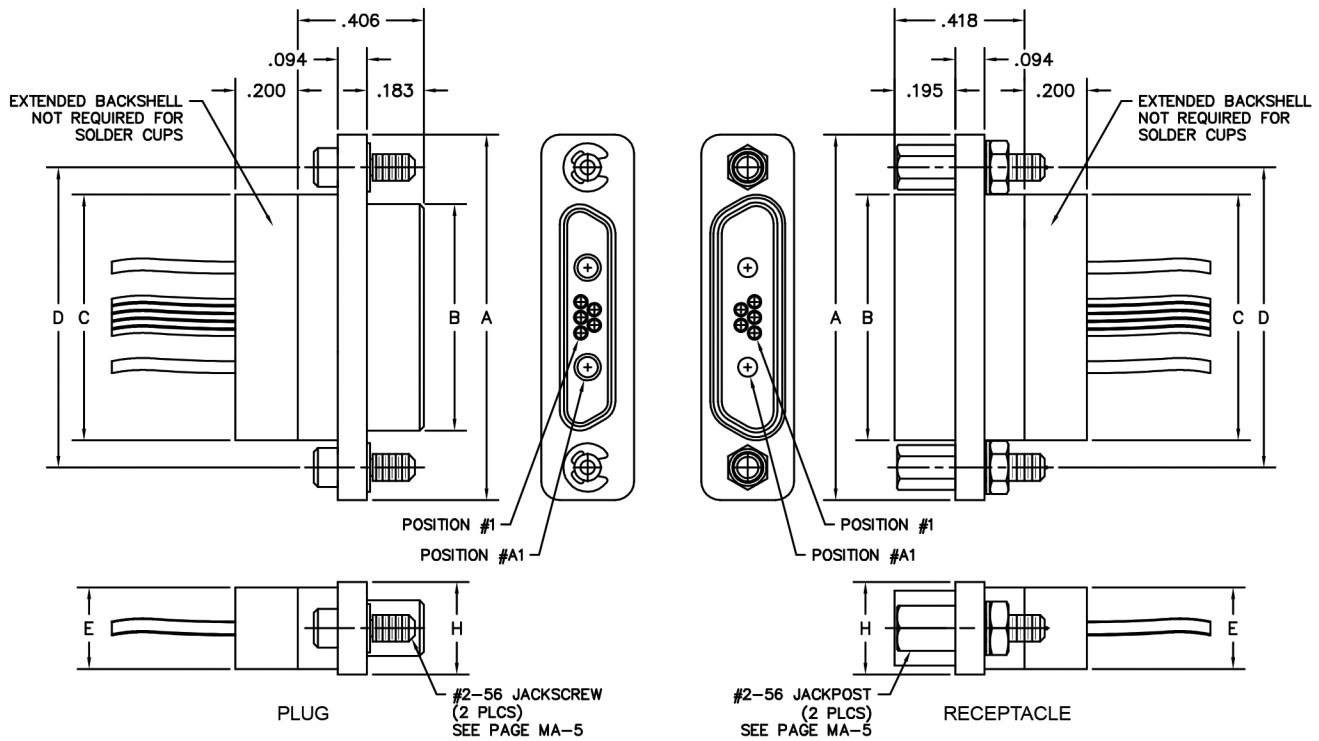

SIZE	CONTACT ROWS	A	B		C	D	E		H	HARDWARE
			PLUG MAX	RCPT MAX			POTTING WELL MAX			
7	2	1.175	.734	.800	.790	.965	.270	.298	#2-56 UNC THD (.092 DIA THRU)	
24	3	1.425	.984	1.050	1.040	1.215	.310	.341		

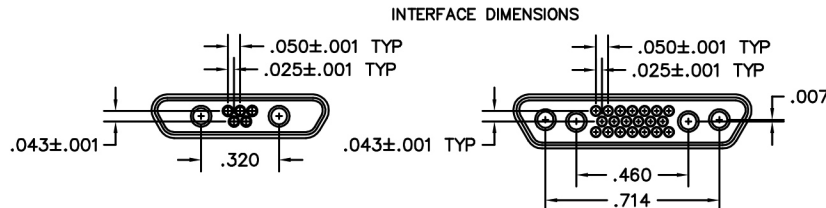



PLUG: MM-2F2-007-P31-41WN  
 RECEPTACLE: MM-2G2-007-P41-22WS  
 XX-XXX-XXX-XXX-XXXX

PLUG		RECEPTACLE	
<b>SERIES</b>			
MM .050" Rugged Metal Connector		MM .050" Rugged Metal Connector	
<b>BODY</b>			
2 2-Row (Size 7)	2 2-Row (Size 7)	3 3-Row (Size 24)	3 3-Row (Size 24)
<b>BODY STYLE:</b> F Plug, straight, with ears		<b>BODY STYLE:</b> G Receptacle, straight, with ears & interfacial seal	
<b>BODY MATERIAL:</b> 2 Polyphenylene Sulfide with electroless nickel shell 3 Polyphenylene Sulfide with electrodeposited cadmium shell <input checked="" type="checkbox"/>		<b>BODY MATERIAL:</b> 2 Polyphenylene Sulfide with electroless nickel shell 3 Polyphenylene Sulfide with electrodeposited cadmium shell <input checked="" type="checkbox"/>	
<b>SIZE</b>			
007 2 Power or Coax and 5 Signal 024 4 Power or Coax and 20 Signal		007 2 Power or Coax and 5 Signal 024 4 Power or Coax and 20 Signal	
<b>CONTACTS</b>			
<b>TYPE CONTACTS/TERMINATIONS:</b> P1 Solder cup, power connector P3 Crimped wire, Power contacts M16878/4-16-9, length per wire code.  C3 Crimped wire, Coax RG316, length per wire code C5 Crimped wire, Coax RG178, length per wire code  Note: Plug connector has pin signal contacts and socket power/coax contacts.		<b>TYPE CONTACTS/TERMINATIONS:</b> P2 Solder cup, power connector P4 Crimped wire, Power contacts M16878/4-16-9, length per wire code.  C4 Crimped wire, Coax RG316, length per wire code C6 Crimped wire, Coax RG178, length per wire code  Note: Receptacle connector has socket signal contacts and pin power/coax contacts.	
<b>PLATING OPTIONS:</b> 1 50 μ" Au contacts (crimp wire) 3 50 μ" Au contacts: 10 μ" Au terminations (solder cup, power connectors only)		<b>PLATING OPTIONS:</b> 1 50 μ" Au contacts (crimp wire) 3 50 μ" Au contacts: 10 μ" Au terminations (solder cup, power connectors only)	
<b>HARDWARE</b>			
<b>STYLE OF HARDWARE:</b> 00 None 22 Two fixed jacknut assemblies 41 Two turning jackscrews, allen head, retaining ring 42 Two long turning jackscrews, allen head, retaining ring 43 Two turning jackscrews, slot head, retaining ring 44 Two long turning jackscrews, slot head, retaining ring 45 Two turning jackscrews, allen head, captivated**		<b>STYLE OF HARDWARE:</b> 00 None 22 Two fixed jacknut assemblies 41 Two turning jackscrews, allen head, retaining ring 42 Two long turning jackscrews, allen head, retaining ring 43 Two turning jackscrews, slot head, retaining ring 44 Two long turning jackscrews, slot head, retaining ring 45 Two turning jackscrews, allen head, captivated**	
<b>WIRING:</b> 00 None XX For wiring codes, see page MA-3 & MA-4		<b>WIRING:</b> 00 None XX For wiring codes, see page MA-3 & MA-4	

\*\* = Captive hardware is factory installed and non-removable.

= Option not RoHS compliant



# Circular Cable Connectors

**.050"**  
**7 & 19 Contacts**

**Rugged Metal**

**MC**

MC-111-007-161-00WN

MC-121-007-261-00WN

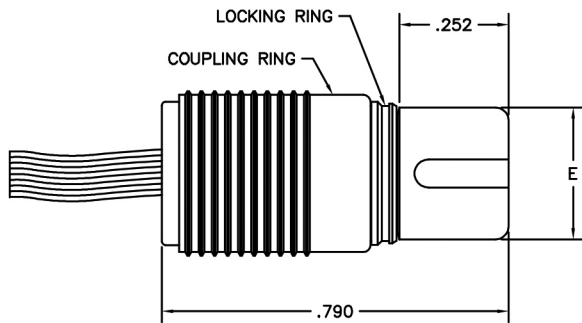
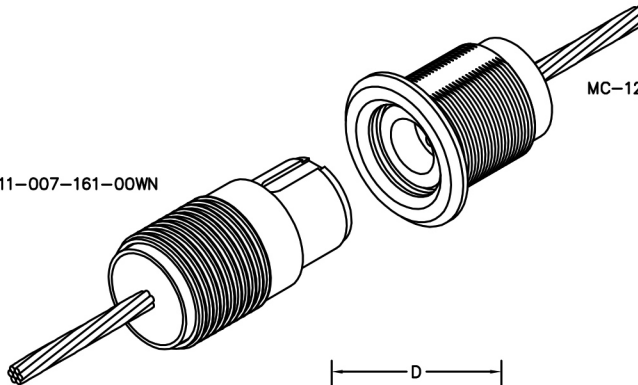

PLUG  
(Socket Contacts)

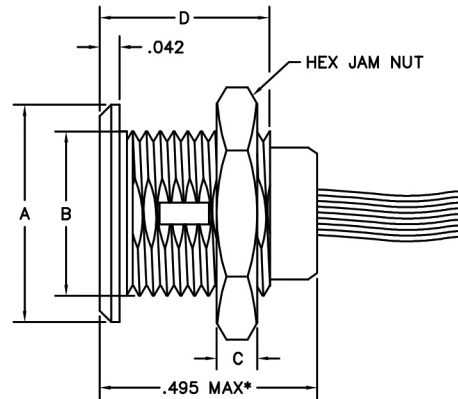

RECEPTACLE  
FRONT PANEL MOUNT  
(Pin Contacts)

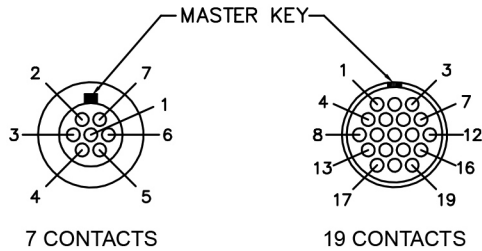

7 CONTACTS

19 CONTACTS

Contact Arrangements

Face view, receptacle (Pin contacts)  
Cavity identification numbers are for reference  
and do not appear on connector.

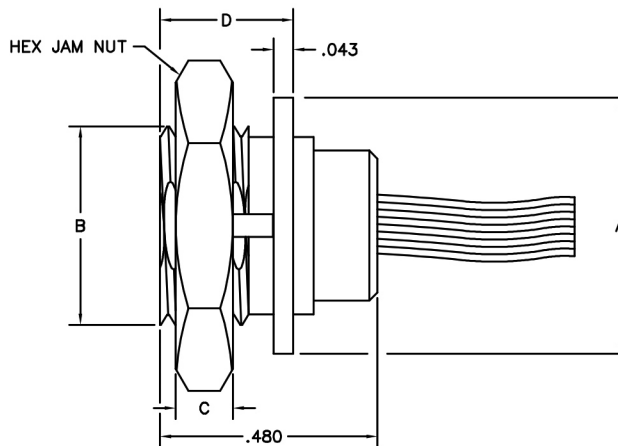

RECEPTACLE  
REAR PANEL MOUNT  
(Pin Contacts)

DIMENSIONS (RECEPTACLE)					
MOUNT	BODY	A MAX DIA	B THREAD	C NUT	D
FRONT PANEL	1 (7 POS)	.510	3/8-32 UNEF-2A	.093	.388
FRONT PANEL	2 (19 POS)	.575	1/2-28 UNEF-2A	.125	.340
REAR PANEL	1 (7 POS)	.575	7/16-28 UNEF-2A	.093	.293
REAR PANEL	2 (19 POS)	.575	1/2-28 UNEF-2A	.125	.305

DIMENSIONS (PLUG)	
BODY	E MAX DIA
1 (7 POS)	.305
2 (19 POS)	.405

\* = .530 MAX FOR SOLDER CUP CONNECTORS

PLUG: MC-111-007-161-00WN  
 RECEPTACLE: MC-121-007-261-00WN  
 XX-XXX-XXX-XXX-XXXX

PLUG		RECEPTACLE	
<b>SERIES</b>			
MC .050" Circular Connector		MC .050" Circular Connector	
<b>BODY</b>			
1 7 position shell	1 7 position shell	2 19 position shell	2 19 position shell
<b>BODY STYLE:</b>		<b>BODY STYLE:</b>	
1 Quick disconnect	2 Front mount, quick disconnect	4 Rear mount, quick disconnect	
<b>BODY MATERIAL:</b>		<b>BODY MATERIAL:</b>	
1 Polyphenylene Sulfide insulator, brass shell with electroless nickel plating	1 Polyphenylene Sulfide insulator, brass shell with electroless nickel plating		
<b>SIZE</b>			
XXX 007, 019		XXX 007, 019	
<b>CONTACTS</b>			
<b>TYPE CONTACTS/TERMINATIONS:</b>		<b>TYPE CONTACTS/TERMINATIONS:</b>	
14 Socket, straight, .500" pigtails (.018 dia)	21 Pin, straight, solder cup	24 Pin, straight, .500" pigtails (.018 dia)	25 Pin, straight, 1.000" pigtails (.018 dia)
15 Socket, straight, 1.000" pigtails (.018 dia)	26 Pin, straight, crimped wire		
16 Socket, straight, crimped wire			
<b>PLATING OPTIONS:</b>		<b>PLATING OPTIONS:</b>	
1 50 μ" Au contacts (crimp wire)	1 50 μ" Au contacts (crimp wire)	3 50 μ" Au contacts: 10 μ" Au terminations (pigtail)	5 50 μ" Au contacts; Sn/Pb alloy terminations (pigtail) <input checked="" type="checkbox"/>
3 50 μ" Au contacts: 10 μ" Au terminations (pigtail)	3 50 μ" Au contacts: 10 μ" Au terminations (solder cup, pigtail)	7 50 μ" Au contacts; SAC305 terminations (pigtail)	
5 50 μ" Au contacts; Sn/Pb alloy terminations (pigtail) <input checked="" type="checkbox"/>			
7 50 μ" Au contacts; SAC305 terminations (pigtail)			
<b>HARDWARE</b>			
<b>STYLE OF HARDWARE:</b>		<b>STYLE OF HARDWARE:</b>	
00 None	00 None		
<b>POLARIZATION / WIRING:</b>		<b>POLARIZATION / WIRING:</b>	
00 None	00 None	XX For wiring codes, see page MA-3 & MA-4	XX For wiring codes, see page MA-3 & MA-4

= Option not RoHS compliant

**PANEL MOUNTING DIMENSIONS**

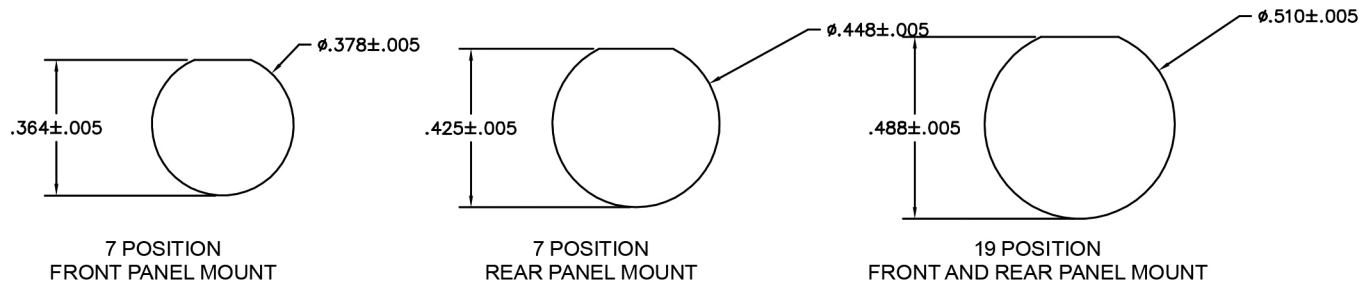



## Specifications - Rear Panel Mount Connectors Materials and Finishes \*

<b>Contacts:</b>	Pins: BeCu alloy strip per ASTM B194 Sockets: Brass per ASTM B121 / B121M or ASTM B453
<b>Contact Finish:</b>	Gold plate per ASTM B488
<b>Shells:</b>	Aluminum Alloy 6061-T6 per SAE AMS-QQ-A-250/11 or 6061-T6511 per SAE AMS-QQ-A-200/8
<b>Aluminum Shell Finishes:</b>	Electroless Nickel per SAE AMS2404, Class 3, 500 $\mu$ " min Electrodeposited Cadmium per SAE AMS-QQ-P-416, Type II, Class 3 Black Anodized per MIL-A-8625, Type III, Class 2
<b>Molded Insulators:</b>	Glass filled polyphenylene sulfide per MIL-M-24519
<b>Embedment:</b>	Frey Engineering Co. insulating compound CF3003-80 and L-II-49 or equivalent
<b>Jackscrews, Jackposts and Nuts:</b>	Corrosion resistant steel per ASTM A320 or ASTM A484 / A484M and ASTM A582 / A582M Passivated per SAE AMS2700
<b>Clips:</b>	Corrosion resistant steel per ASME 18.24 (For reference only: ASME 18.24 CRS per ASTM A693) Passivated per ASME 18.24 (For reference only: ASME 18.24 passivated per SAE AMS2700)
<b>Gaskets:</b>	Interfacial: Fluorosilicone per SAE AMS-R-25988 Flange: Fluorosilicone per SAE AMS-R-25988 Flange EMI: Conductive Elastomer per MIL-DTL-83528, Type D
<b>Tolerances:</b>	Unless otherwise specified: Fractions = $\pm 1/64$ " Decimals = $\pm 0.010$ " Angles = $\pm 5^\circ$ Wire lengths: insulated/stranded = $+1.0/-0.0$ " uninsulated/solid = $+0.2/-0.0$ "

Note: AirBorn can manufacture special configurations for your exact specifications.

\* = Reference the above listed specifications or an equivalent industry standard when applicable



## Performance - Rear Panel Mount Connectors

<b>Contact Rating:</b>	3-amperes maximum
<b>Solderability:</b>	Terminals (except crimp) tested in accordance with MIL-STD-202, Method 208
<b>Wire Size:</b>	Stranded #26 AWG or solid #25 AWG standard (consult factory for other sizes and types)
<b>Test Voltage:</b>	600 V, RMS, 60 Hz
<b>Operating Temperature:</b>	-55° C to +125° C
<b>Insulation Resistance:</b>	5,000 megohms minimum @ 500 VDC
<b>Durability:</b>	500 connector mating cycles
<b>Vibration:</b>	Tested in accordance with MIL-STD-1344, Method 2005, Condition IV, according to MIL-83513
<b>Shock:</b>	Tested in accordance with MIL-STD-1344, Method 2004, Condition E, according to MIL-83513
<b>Salt Spray:</b>	Mated connectors tested in accordance with MIL-STD-1344, Method 1001, Test Condition B
<b>Humidity:</b>	Mated connectors tested in accordance with MIL-STD-1344, Method 1002, Type II (except steps 7a and 7b)
<b>Thermal Shock:</b>	Tested to the temperature extremes of MIL-STD-1344, Method 1003, Test Condition A (except step 3, temperature shall be 125° C)
<b>Contact Resistance:</b>	0.065 volt maximum drop @ 2.5 amps (.026 ohms)
<b>Contact Engaging Force:</b>	6.0 ounce maximum, with .0221 diameter test sleeve
<b>Contact Separating Force:</b>	0.5 ounce minimum, with .0230 diameter test sleeve
<b>Crimp Strength:</b>	5 pound minimum tensile strength
<b>Sealing:</b>	When mated, AirBorn rear panel mount connectors provide an environmental seal to water, moisture and certain chemicals as well as a dust and dirt barrier.



# Cable to Cable (Rear Panel Mount)

.050"  
9 thru 100 Contacts

Rugged Metal    Rugged Plastic

**MM**

**MN**

MM-212-031-161-41WQ  
(METAL)

MN-211-031-161-41WQ  
(PLASTIC)

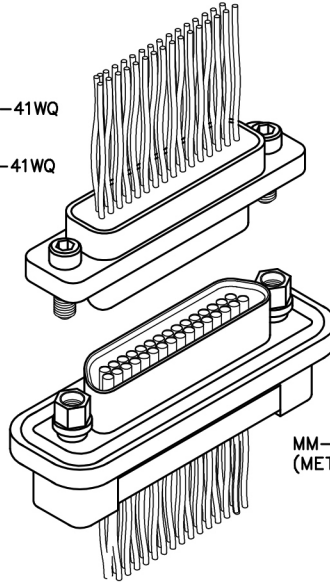

MM-2C2-031-261-26WA-EM  
(METAL)

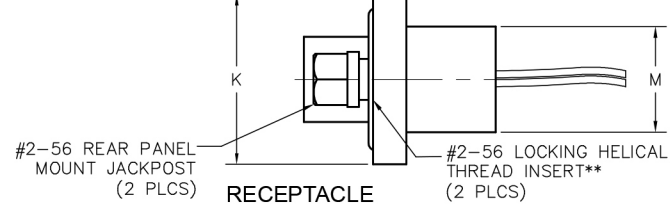
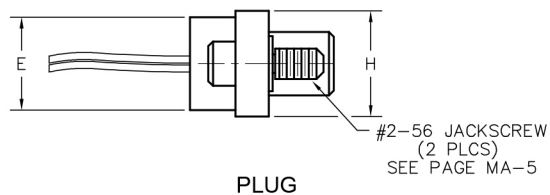
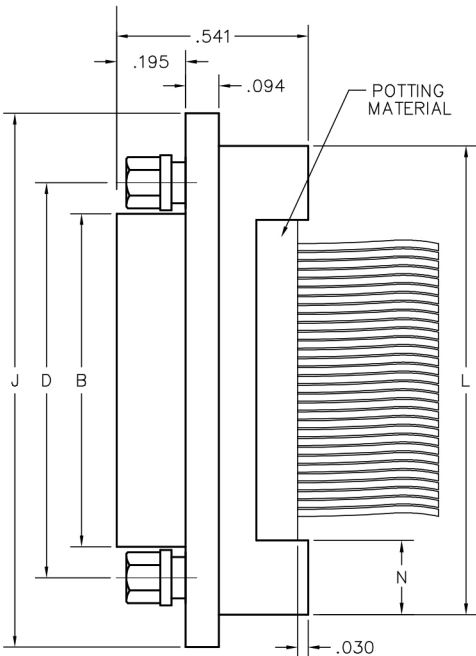
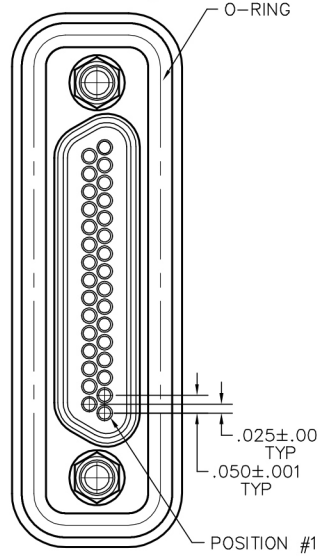
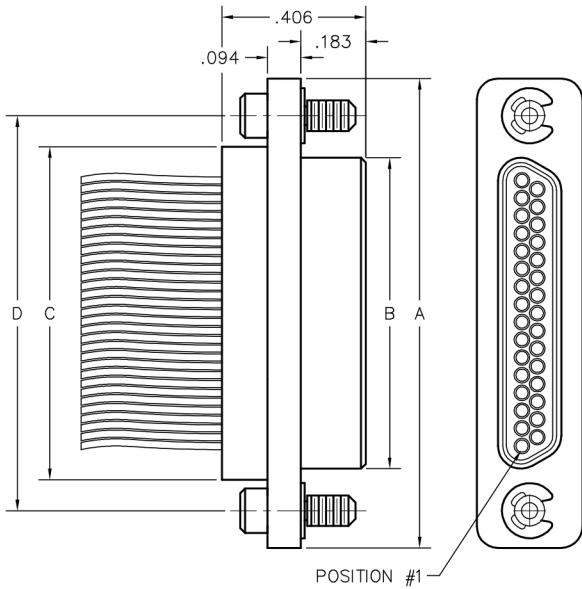

SIZE	CONTACT ROWS	DIMENSIONS												
		A	B		C	D	E	H	HARDWARE	J	K	L	M	N
			PLUG MAX	RCPT MAX										
9	2	.775	.334	.400	.390	.565	.270	.298	#2-56 UNC THD	.957	.480	.773	.298	.210
15		.925	.484	.550	.540	.715				1.107		.923		
21		1.075	.634	.700	.690	.865				1.257		1.073		
25		1.175	.734	.800	.790	.965				1.357		1.173		
31		1.325	.884	.950	.940	1.115				1.507		1.323		
37	1.475	1.034	1.100	1.090	1.265	1.657	1.473							
51	3	1.425	.984	1.050	1.040	1.215	.310	.341	#2-56 UNC THD	1.657	.523	1.477	.440	.239
69*		1.725	1.284	1.350	1.340	1.515				1.957		1.777		
100		2.160	1.384	1.508	1.432	1.800				2.383		.600		

\* = 69 POSITION CONNECTORS ARE AVAILABLE IN METAL ONLY.

\*\* = SHELL ACCEPTS .200 MAX #2-56 SCREW LENGTH (.295 MAX #4-40 SCREW LENGTH).



**PLUG:** MM-212-031-161-41WQ  
**RECEPTACLE:** MM-2C2-031-261-26WA-EMI  
**PLUG:** MN-211-031-161-41WQ  
**RECEPTACLE:** MM-2C2-031-261-26WA-EMI  
 XX-XXX-XXX-XXX-XXXX-XXX

PLUG		RECEPTACLE	
<b>SERIES</b>			
MM .050" Rugged Metal I/O Connector MN .050" Rugged Plastic I/O Connector (MM & MN mate with MK, ML, MM, MN receptacles)	MM .050" Rugged Metal I/O Connector (MM mates with MK, ML, MM, MN plugs)		
<b>BODY</b>			
2 2-Row (Sizes 9 thru 37) 3 3-Row (Size 51 or 69) 4 4-Row (Size 100)	2 2-Row (Sizes 9 thru 37) 3 3-Row (Size 51 or 69) 4 4-Row (Size 100)		
BODY STYLE: 1 Plug, straight, with ears	BODY STYLE: C Receptacle, straight, rear panel mount, with fluorosilicone o-ring and interfacial seal		
BODY MATERIAL: 1 Polyphenylene Sulfide (MN only) 2 Polyphenylene Sulfide with electroless nickel shell 3 Polyphenylene Sulfide with electrodeposited cadmium shell <input checked="" type="checkbox"/> 4 Polyphenylene Sulfide with hard anodized black shell	BODY MATERIAL: 2 Polyphenylene Sulfide with electroless nickel shell 3 Polyphenylene Sulfide with electrodeposited cadmium shell <input checked="" type="checkbox"/> 4 Polyphenylene Sulfide with hard anodized black shell		
<b>SIZE</b>			
XXX 009, 015, 021, 025, 031, 037, 051, 069, 100		XXX 009, 015, 021, 025, 031, 037, 051, 069, 100	
<b>CONTACTS</b>			
TYPE CONTACTS/TERMINATIONS: 11 Pin, straight, 26 awg solder cup 1A Pin, straight, 24 awg solder cup 14 Pin, straight, .500" pigtails (.018 dia) 15 Pin, straight, 1.000" pigtails (.018 dia) 16 Pin, straight, crimped wire		TYPE CONTACTS/TERMINATIONS: 21 Socket, straight, 26 awg solder cup 2A Socket, straight, 24 awg solder cup 24 Socket, straight, .500" pigtails (.018 dia) 25 Socket, straight, 1.000" pigtails (.018 dia) 26 Socket, straight, crimped wire	
PLATING OPTIONS: 1 50 μ" Au contacts (crimp wire) 3 50 μ" Au contacts: 10 μ" Au terminations (solder cup, pigtail) 5 50 μ" Au contacts; Sn/Pb alloy terminations (pigtail) <input checked="" type="checkbox"/> 7 50 μ" Au contacts; SAC305 terminations (pigtail)		PLATING OPTIONS: 1 50 μ" Au contacts (crimp wire) 3 50 μ" Au contacts: 10 μ" Au terminations (solder cup, pigtail) 5 50 μ" Au contacts; Sn/Pb alloy terminations (pigtail) <input checked="" type="checkbox"/> 7 50 μ" Au contacts; SAC305 terminations (pigtail)	
<b>HARDWARE</b>			
STYLE OF HARDWARE: 00 None 41 Two turning jackscrews, allen head, retaining ring (81*) 42 Two long turning jackscrews, allen head, retaining ring (82*) 43 Two turning jackscrews, slot head, retaining ring (83*) 44 Two long turning jackscrews, slot head, retaining ring (84*) 45 Two turning jackscrews, allen head, captivated** (85*)		STYLE OF HARDWARE: 00 None 24 Two fixed jacknuts, rear panel mount, .040" panel thickness (64*) 26 Two fixed jacknuts, rear panel mount, .060" panel thickness (66*) 28 Two fixed jacknuts, rear panel mount, .070" panel thickness (68*) 29 Two fixed jacknuts, rear panel mount, .080" panel thickness (69*)	
POLARIZATION / WIRING: 00 None XX For wiring codes, see page MA-3 & MA-4		POLARIZATION / WIRING: 00 None XX For wiring codes, see page MA-3 & MA-4	
<b>OPTIONS</b>			
EM I EMI o-ring (in lieu of fluorosilicone o-ring)			

\* = Use number in parenthesis when ordering size 100.  
 \*\* = Captive hardware is factory installed and non-removable.  
 = Option not RoHS compliant



# Cable to Cable (Rear Panel Mount)

.050"  
9 thru 100 Contacts

Rugged Metal

Rugged Plastic

**MM**

**MN**

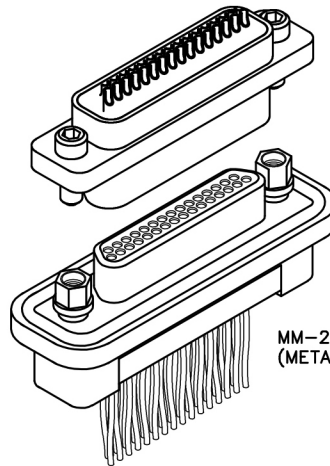

MM-222-031-2A3-2200  
(METAL)

MN-221-031-2A3-2200  
(PLASTIC)

MM-2A2-031-161-26WA-EMI  
(METAL)

3 AND 4 ROW SOLDER CUPS

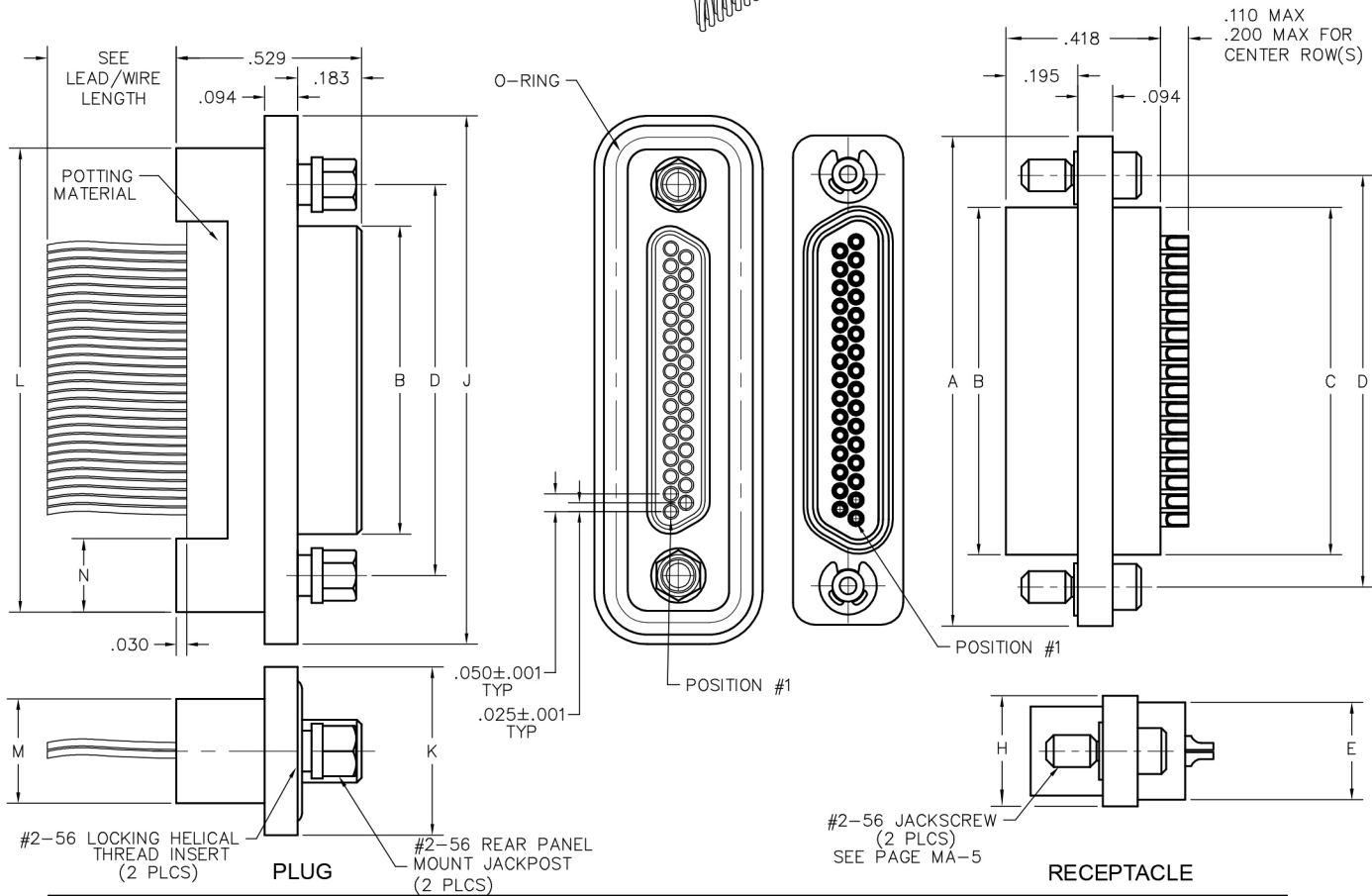

SIZE	CONTACT ROWS	DIMENSIONS												
		A	B		C	D	E	H	HARDWARE	J	K	L	M	N
			PLUG MAX	RCPT MAX										
9	2	.775	.334	.400	.390	.565	.270	.298	#2-56 UNC THD (.092 DIA THRU)	.957	.480	.773	.298	.210
15		.925	.484	.550	.540	.715				1.107		.923		
21		1.075	.634	.700	.690	.865				1.257		1.073		
25		1.175	.734	.800	.790	.965				1.357		1.173		
31		1.325	.884	.950	.940	1.115				1.507		1.323		
37		1.475	1.034	1.100	1.090	1.265				1.657		1.473		
51	3	1.425	.984	1.050	1.040	1.215	.310	.341	1.657	.523	1.477	.440	.239	
69*		1.725	1.284	1.350	1.340	1.515					1.957			1.777
100		2.160	1.384	1.508	1.432	1.800					.360			.384

\* = 69 POSITION CONNECTORS ARE AVAILABLE IN METAL ONLY.



**PLUG:** MM-2A2-031-161-26WA-EMI  
**RECEPTACLE:** MM-222-031-2G3-4500  
**PLUG:** MN-2A2-031-161-26WA-EMI  
**RECEPTACLE:** MN-221-031-2G3-4500

PLUG		RECEPTACLE	
<b>SERIES</b>			
MM .050" Rugged Metal I/O Connector (MM mateS with MK, ML, MM, MN receptacles)		MM .050" Rugged Metal I/O Connector MN .050" Rugged Plastic I/O Connector (MM & MN mate with MK, ML, MM, MN plugs)	
<b>BODY</b>			
2 2-Row (Sizes 9 thru 37)	3 3-Row (Size 51 & 69)	2 2-Row (Sizes 9 thru 37)	3 3-Row (Size 51 & 69)
4 4-Row (Size 100)		4 4-Row (Size 100)	
BODY STYLE: A Plug, straight, rear panel mount, with fluorosilicone o-ring		BODY STYLE: 2 Receptacle, straight, with ears	
BODY MATERIAL: 2 Polyphenylene Sulfide with electroless nickel shell 3 Polyphenylene Sulfide with electrodeposited cadmium shell ☒ 4 Polyphenylene Sulfide with hard anodized black shell A Pure Electro-Deposited Aluminum K Zinc Nickel Plating T Nickel Polymer Plating		BODY MATERIAL: 1 Polyphenylene Sulfide (MN only) 2 Polyphenylene Sulfide with electroless nickel shell 3 Polyphenylene Sulfide with electrodeposited cadmium shell ☒ 4 Polyphenylene Sulfide with hard anodized black shell A Pure Electro-Deposited Aluminum K Zinc Nickel Plating T Nickel Polymer Plating	
<b>SIZE</b>			
XXX 009, 015, 021, 025, 031, 037, 051, 069, 100		XXX 009, 015, 021, 025, 031, 037, 051, 069, 100	
<b>CONTACTS</b>			
TYPE CONTACTS/TERMINATIONS: 11 Pin, straight, 26 awg solder cup 1A Pin, straight, 24 awg solder cup 1D Pin, straight, .109" Lead Length (.018 dia) SEE NOTE 1 1E Pin, straight, .125" Lead Length (.018 dia) SEE NOTE 1 1F Pin, straight, .140" Lead Length (.018 dia) SEE NOTE 1 12 Pin, straight, .150" Lead Length (.018 dia) SEE NOTE 1 1G Pin, straight, .156" Lead Length (.018 dia) SEE NOTE 1 1H Pin, straight, .172" Lead Length (.018 dia) SEE NOTE 1 1J Pin, straight, .187" Lead Length (.018 dia) SEE NOTE 1 13 Pin, straight, .250" Lead Length (.018 dia) SEE NOTE 1 1K Pin, straight, .375" Lead Length (.018 dia) SEE NOTE 1 14 Pin, straight, .500" Lead Length (.018 dia) SEE NOTE 1 15 Pin, straight, 1.000" Lead Length (.018 dia) SEE NOTE 1 16 Pin, straight, crimped wire		TYPE CONTACTS/TERMINATIONS: 21 Socket, straight, 26 awg solder cup 2A Socket, straight, 24 awg solder cup 2D Socket, straight, .109" Lead Length (.018 dia) 2E Socket, straight, .125" Lead Length (.018 dia) 2F Socket, straight, .140" Lead Length (.018 dia) 22 Socket, straight, .150" Lead Length (.018 dia) 2G Socket, straight, .156" Lead Length (.018 dia) 2H Socket, straight, .172" Lead Length (.018 dia) 2J Socket, straight, .187" Lead Length (.018 dia) 23 Socket, straight, .250" Lead Length (.018 dia) 2K Socket, straight, .375" Lead Length (.018 dia) 2L Socket, straight, .500" Lead Length (.018 dia) 2M Socket, straight, 1.000" Lead Length (.018 dia) 24 Socket, straight, .500" Lead Length (.018 dia) SEE NOTE 1 25 Socket, straight, 1.000" Lead Length (.018 dia) SEE NOTE 1 26 Socket, straight, crimped wire	
PLATING OPTIONS: 1 50 μ" Au contacts (crimp wire) 3 50 μ" Au contacts: 10 μ" Au Terminations (solder cup, pigtail) 5 50 μ" Au contacts; Sn/Pb alloy terminations (pigtail) ☒ 7 50 μ" Au contacts; SAC305 terminations (pigtail)		PLATING OPTIONS: 1 50 μ" Au contacts (crimp wire) 3 50 μ" Au contacts: 10 μ" Au Terminations (solder cup, pigtail) 5 50 μ" Au contacts; Sn/Pb alloy terminations (pigtail) ☒ 7 50 μ" Au contacts; SAC305 terminations (pigtail)	
<b>HARDWARE</b>			
STYLE OF HARDWARE: 00 None 24 Two fixed jacknuts, rear panel mount, .040" panel thickness (64*) 26 Two fixed jacknuts, rear panel mount, .060" panel thickness (66*) 28 Two fixed jacknuts, rear panel mount, .070" panel thickness (68*) 29 Two fixed jacknuts, rear panel mount, .080" panel thickness (69*)		STYLE OF HARDWARE: 00 None 41 Two turning jackscrews, allen head, retaining ring (81*) 42 Two long turning jackscrews, allen head, retaining ring (82*) 43 Two turning jackscrews, slot head, retaining ring (83*) 44 Two long turning jackscrews, slot head, retaining ring (84*) 45 Two turning jackscrews, allen head, captivated** (85*)	
POLARIZATION / WIRING 00 None XX For wiring codes, see page MA-3 & MA-4		POLARIZATION / WIRING 00 None XX For wiring codes, see page MA-3 & MA-4	
<b>OPTIONS</b>			
EMI EMI o-ring (in lieu of fluorosilicone o-ring)		900 Interfacial sealing gasket	

\* = Use number in parenthesis when ordering size 100.  
 \*\* = Captive hardware is factory installed and non-removable.  
 ☒ = Option not RoHS compliant

NOTE 1 = The leads on these contacts are soft copper suitable for forming.



# Cable to Board (Rear Panel Mount)

**.050"**  
**9 thru 100 Contacts**

## Rugged Board Mount

**MK**

## Rugged Cable

**MM, MN**

MM-212-031-161-41WQ  
(METAL)  
MN-211-031-161-41WQ  
(PLASTIC)

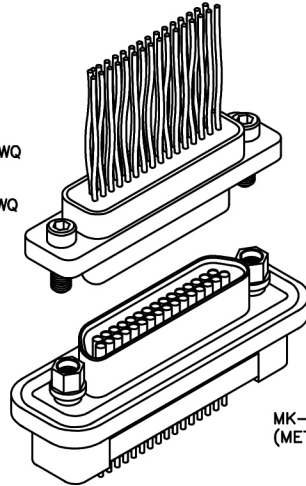

MK-2C2-031-235-2600  
(METAL)

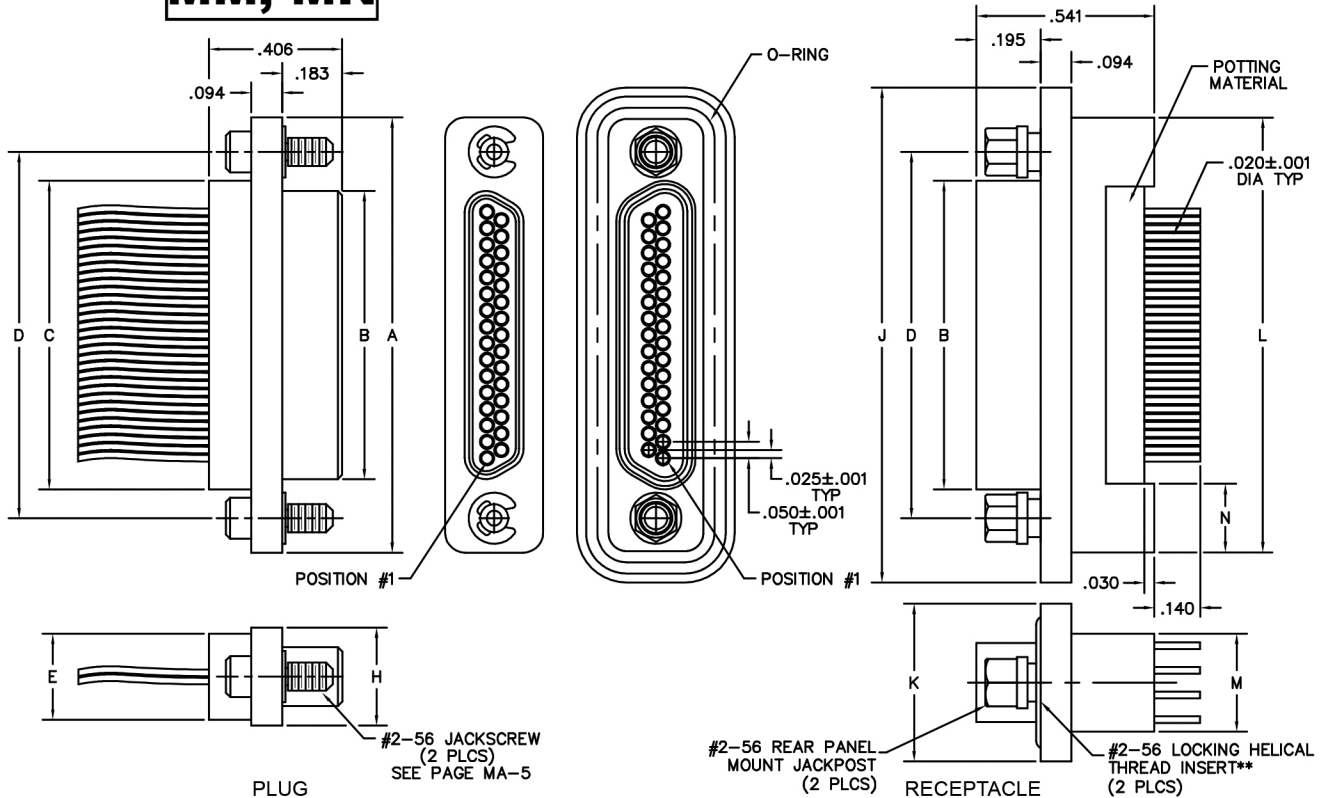

SIZE	CONTACT ROWS	DIMENSIONS												
		A	B		C	D	E		H	HARDWARE	J	K	L	M
		PLUG MAX	RCPT MAX			POTTING WELL MAX								
9	2	.775	.334	.400	.390	.565	.270	.298	#2-56 UNC THD	.957	.480	.773	.298	.210
15		.925	.484	.550	.540	.715				1.107		.923		
21		1.075	.634	.700	.690	.865				1.257		1.073		
25		1.175	.734	.800	.790	.965				1.357		1.173		
31		1.325	.884	.950	.940	1.115				1.507		1.323		
37		1.475	1.034	1.100	1.090	1.265				1.657		1.473		
51	3	1.425	.984	1.050	1.040	1.215	.310	.341	#2-56 UNC THD	1.657	.523	1.477	.440	.239
69*		1.725	1.284	1.350	1.340	1.515				1.957		1.777		
100		2.160	1.384	1.508	1.432	1.800				.360		.384		

\* = 69 POSITION CONNECTORS ARE AVAILABLE IN METAL ONLY.  
\*\* = SHELL ACCEPTS .200 MAX #2-56 SCREW LENGTH (.295 MAX #4-40 SCREW LENGTH).



**PLUG:** MM-212-031-161-41WQ  
**RECEPTACLE:** MK-2C2-031-235-2600-EMI  
**PLUG:** MN-211-031-161-41WQ  
**RECEPTACLE:** MK-2C2-031-235-2600-EMI  
 XX-XXX-XXX-XXX-XXXX-XXX

PLUG		RECEPTACLE	
<b>SERIES</b>			
MM .050" Rugged Metal I/O Connector	MN .050" Rugged Plastic I/O Connector (MM & MN mate with MK, ML, MM, MN receptacles)	MK .050" Rugged Metal PC Board Mount Connector (MK mates with MK, ML, MM, MN plugs)	
<b>BODY</b>			
2 2-Row (Sizes 9 thru 37)	3 3-Row (Size 51 or 69)	4 4-Row (Size 100)	
<b>BODY STYLE:</b>		<b>BODY STYLE:</b>	
1 Plug, straight, with ears	C Receptacle, straight, standard footprint, rear panel mount with fluorosilicone o-ring and interfacial seal		
<b>BODY MATERIAL:</b>		<b>BODY MATERIAL:</b>	
1 Polyphenylene Sulfide (MN only)	2 Polyphenylene Sulfide with electroless nickel shell	3 Polyphenylene Sulfide with electrodeposited cadmium shell <input checked="" type="checkbox"/>	4 Polyphenylene Sulfide with hard anodized black shell
A Pure Electro-Deposited Aluminum	K Zinc Nickel Plating	T Nickel Polymer Plating	
<b>SIZE</b>			
XXX 009, 015, 021, 025, 031, 037, 051, 069, 100		XXX 009, 015, 021, 025, 031, 037, 051, 069, 100	
<b>CONTACTS</b>			
<b>TYPE CONTACTS/TERMINATIONS:</b>		<b>TYPE CONTACTS/TERMINATIONS:</b>	
11 Pin, straight, solder cup	14 Pin, straight, .500" pigtails (.018 dia)	15 Pin, straight, 1.000" pigtails (.018 dia)	16 Pin, straight, crimped wire
<b>PLATING OPTIONS:</b>		<b>PLATING OPTIONS:</b>	
1 50 μ" Au contacts (crimp wire)	3 50 μ" Au contacts; 10 u" Au terminations (solder cup, pigtail)	5 50 μ" Au contacts; Sn/Pb alloy terminations (pigtail) <input checked="" type="checkbox"/>	7 50 μ" Au contacts; SAC305 terminations (pigtail)
<b>HARDWARE</b>			
<b>STYLE OF HARDWARE:</b>		<b>STYLE OF HARDWARE:</b>	
00 None	41 Two turning jackscrews, allen head, retaining ring (81*)	42 Two long turning jackscrews, allen head, retaining ring (82*)	43 Two turning jackscrews, slot head, retaining ring (83*)
44 Two long turning jackscrews, slot head, retaining ring (84*)	45 Two turning jackscrews, allen head, captivated** (85*)	00 None	24 Two fixed jacknuts, rear panel mount, .040" panel thickness (64*)
		26 Two fixed jacknuts, rear panel mount, .060" panel thickness (66*)	28 Two fixed jacknuts, rear panel mount, .070" panel thickness (68*)
		29 Two fixed jacknuts, rear panel mount, .080" panel thickness (69*)	
<b>POLARIZATION / WIRING:</b>		<b>POLARIZATION / WIRING:</b>	
00 None	XX For wiring codes, see page MA-3 & MA-4	00 None	
<b>OPTIONS</b>			
		EMI EMI o-ring (in lieu of fluorosilicone o-ring)	

\* = Use number in parenthesis when ordering size 100.  
 \*\* = Captive hardware is factory installed and non-removable.  
 = Option not RoHS compliant



# Cable to Board (Rear Panel Mount)

**.050"**

**9 thru 100 Contacts**

**Rugged Board Mount**

**MK**

**Rugged Cable**

**MM, MN**

MM-222-031-261-41WQ  
(METAL)

MN-221-031-261-41WQ  
(PLASTIC)

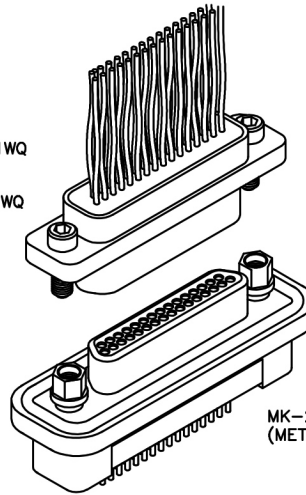

MK-2A2-031-135-2600-EMI  
(METAL)

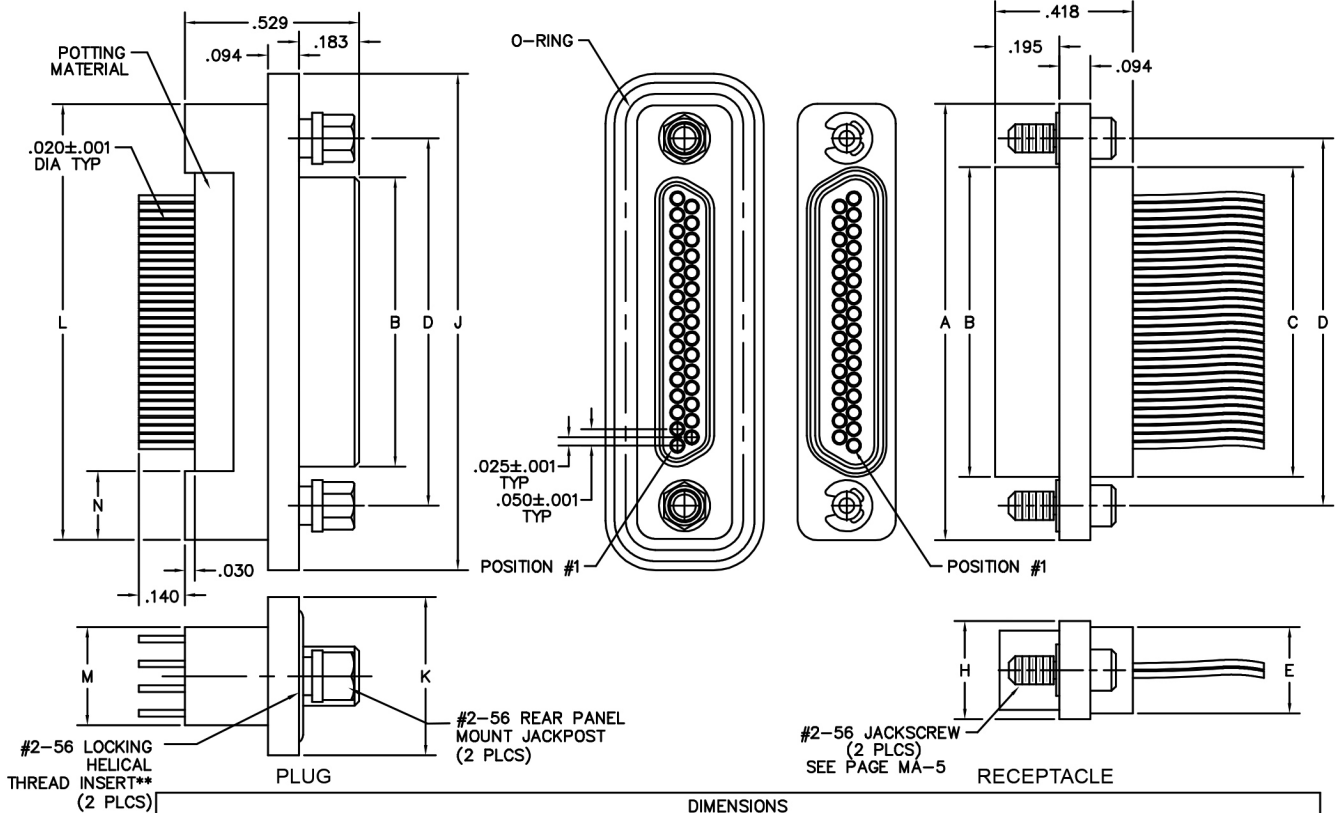

SIZE	CONTACT ROWS	DIMENSIONS												
		A	B		C	D	E	H	HARDWARE	J	K	L	M	N
			PLUG MAX	RCPT MAX			POTTING WELL MAX							
9	2	.775	.334	.400	.390	.565	.270	.298	#2-56 UNC THD	.957	.480	.773	.298	.210
15		.925	.484	.550	.540	.715				1.107		.923		
21		1.075	.634	.700	.690	.865				1.257		1.073		
25		1.175	.734	.800	.790	.965				1.357		1.173		
31		1.325	.884	.950	.940	1.115				1.507		1.323		
37		1.475	1.034	1.100	1.090	1.265	1.657	1.473						
51	3	1.425	.984	1.050	1.040	1.215	.310	.341	#2-56 UNC THD	1.657	.523	1.477	.440	.239
69*		1.725	1.284	1.350	1.340	1.515				1.957		1.777		
100		4	2.160	1.384	1.508	1.432				1.800		.360		

\* = 69 POSITION CONNECTORS ARE AVAILABLE IN METAL ONLY.

\*\* = SHELL ACCEPTS .200 MAX #2-56 SCREW LENGTH (.295 MAX #4-40 SCREW LENGTH).



**PLUG:** MK- 2A2-031 - 135-2600-EMI  
**RECEPTACLE:** MM- 222-031 - 261-41WQ  
**PLUG:** MK- 2A2-031 - 135-2600-EMI  
**RECEPTACLE:** MN- 221-031 - 261-41WQ  
 XX-XXX-XXX-XXX-XXXX-XXX

**PLUG**

**RECEPTACLE**

SERIES	
MK .050" Rugged Metal PC Board Mount Connector (MK mates with MK, ML, MM, MN receptacles)	MM .050" Rugged Metal I/O Connector MN .050" Rugged Plastic I/O Connector (MM & MN mate with MK, ML, MM, MN plugs)
BODY	
2 2-Row (Sizes 9 thru 37) 3 3-Row (Size 51 or 69) 4 4-Row (Size 100)	2 2-Row (Sizes 9 thru 37) 3 3-Row (Size 51 or 69) 4 4-Row (Size 100)
<b>BODY STYLE:</b> A Plug, straight, standard footprint, rear panel mount with fluorosilicone o-ring	<b>BODY STYLE:</b> 2 Receptacle, straight, with ears
<b>BODY MATERIAL:</b> 2 Polyphenylene Sulfide with electroless nickel shell 3 Polyphenylene Sulfide with electrodeposited cadmium shell <input checked="" type="checkbox"/> 4 Polyphenylene Sulfide with hard anodized black shell	<b>BODY MATERIAL:</b> 1 Polyphenylene Sulfide (MN only) 2 Polyphenylene Sulfide with electroless nickel shell 3 Polyphenylene Sulfide with electrodeposited cadmium shell <input checked="" type="checkbox"/> 4 Polyphenylene Sulfide with hard anodized black shell
SIZE	
XXX 009, 015, 021, 025, 031, 037, 051, 069, 100	XXX 009, 015, 021, 025, 031, 037, 051, 069, 100
CONTACTS	
<b>TYPE CONTACTS/TERMINATIONS:</b> 12 Pin, straight, PCB leads, .109" 13 Pin, straight, PCB leads, .140" 14 Pin, straight, PCB leads, .172"	<b>TYPE CONTACTS/TERMINATIONS:</b> 21 Socket, straight, solder cup 24 Socket, straight, .500" pigtails (.018 dia) 25 Socket, straight, 1.000" pigtails (.018 dia) 26 Socket, straight, crimped wire
<b>PLATING OPTIONS:</b> 3 50 μ" Au contacts; 10 μ" Au terminations 5 50 μ" Au contacts; Sn/Pb alloy terminations <input checked="" type="checkbox"/> 7 50 μ" Au contacts; SAC305 terminations	<b>PLATING OPTIONS:</b> 1 50 μ" Au contacts (crimp wire) 3 50 μ" Au contacts; 10 μ" Au terminations (solder cup, pigtail) 5 50 μ" Au contacts; Sn/Pb alloy terminations (pigtail) <input checked="" type="checkbox"/> 7 50 μ" Au contacts; SAC305 terminations (pigtail)
HARDWARE	
<b>STYLE OF HARDWARE:</b> 00 None 24 Two fixed jacksnuts, rear panel mount, .040" panel thickness (64*) 26 Two fixed jacksnuts, rear panel mount, .060" panel thickness (66*) 28 Two fixed jacksnuts, rear panel mount, .070" panel thickness (68*) 29 Two fixed jacksnuts, rear panel mount, .080" panel thickness (69*)	<b>STYLE OF HARDWARE:</b> 00 None 41 Two turning jackscrews, allen head, retaining ring (81*) 42 Two long turning jackscrews, allen head, retaining ring (82*) 43 Two turning jackscrews, slot head, retaining ring (83*) 44 Two long turning jackscrews, slot head, retaining ring (84*) 45 Two turning jackscrews, allen head, captivated** (85*)
<b>POLARIZATION / WIRING:</b> 00 None	<b>POLARIZATION / WIRING:</b> 00 None XX For wiring codes, see page MA-3 & MA-4
OPTIONS	
EMI EMI o-ring (in lieu of fluorosilicone o-ring)	900 Interfacial sealing gasket

\* = Use number in parenthesis when ordering size 100.  
 \*\* = Captive hardware is factory installed and non-removable.  
 = Option not RoHS compliant

# Recommended PC Board Layout

## Straight, Standard Footprint

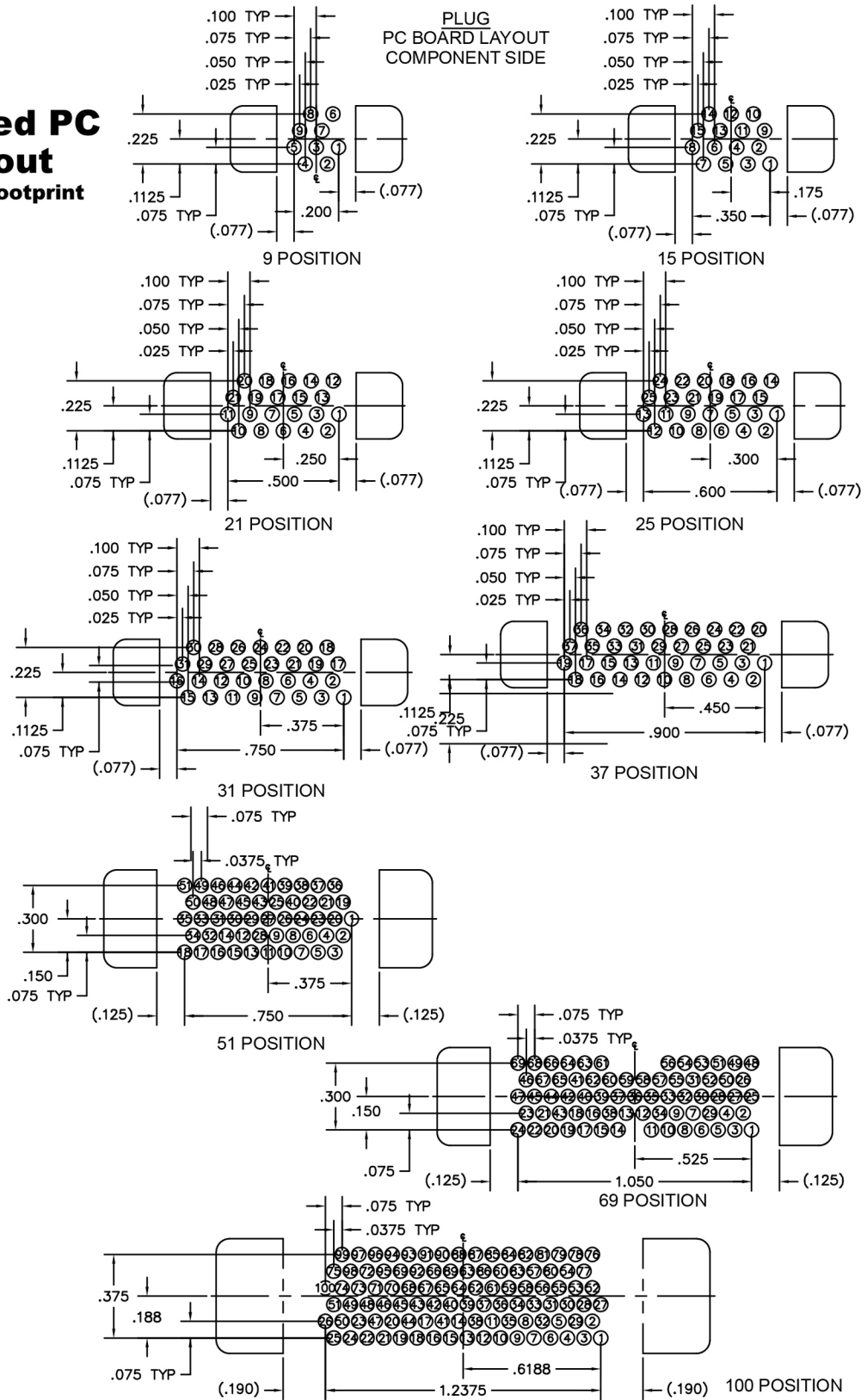
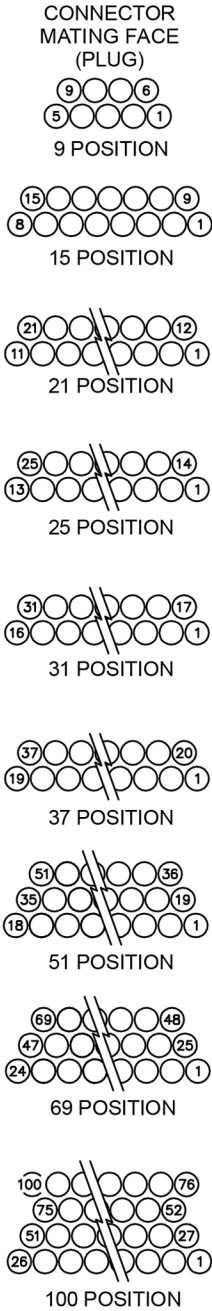

## Recommended PC Board Layout

Straight, Standard Footprint

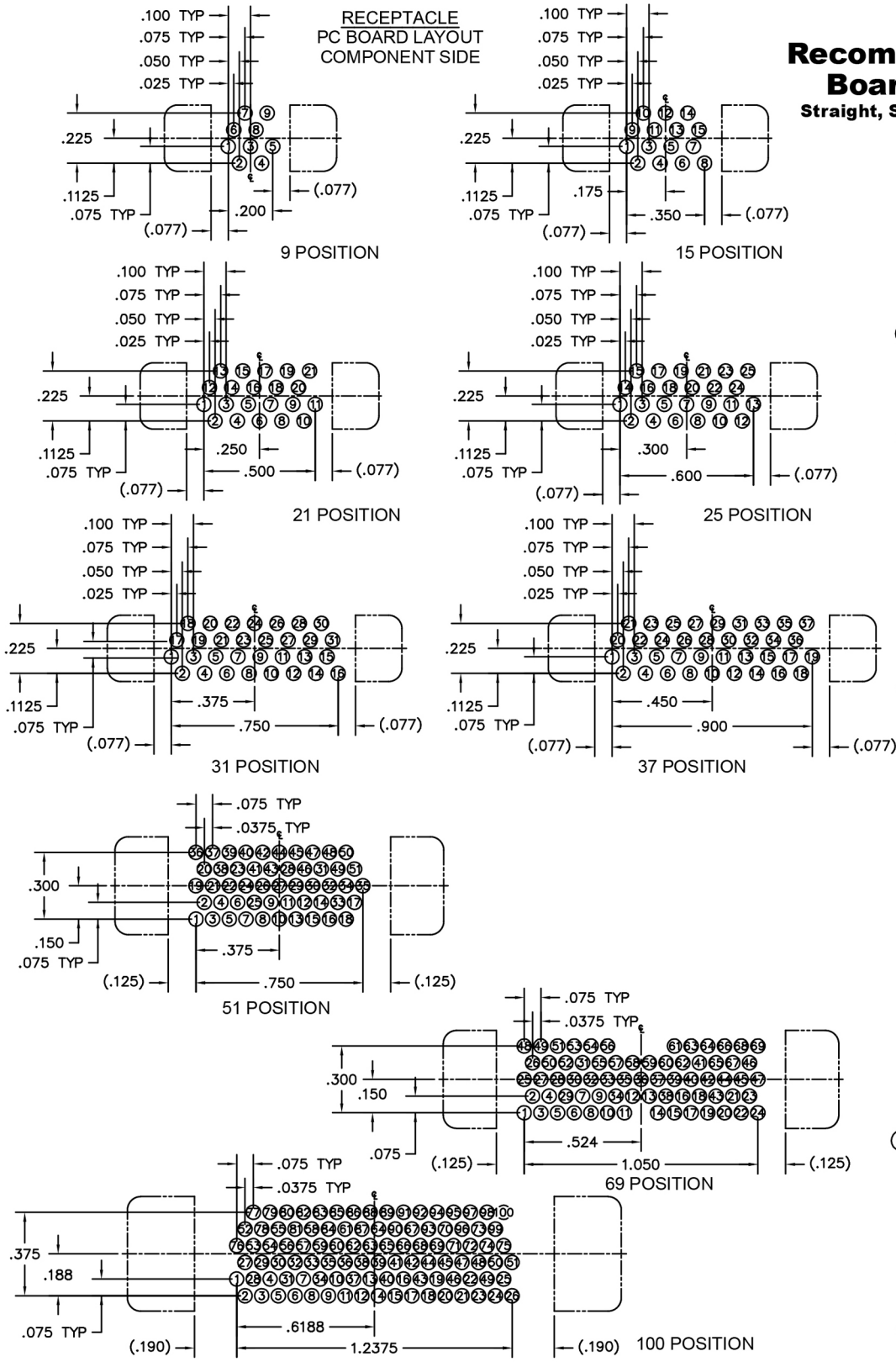

CONNECTOR  
MATING FACE  
(RECEPTACLE)



9 POSITION



15 POSITION



21 POSITION



25 POSITION



31 POSITION



37 POSITION



51 POSITION



69 POSITION



100 POSITION



**Rear Panel Mount,  
Right Angle  
Boardmount  
.050"  
9 thru 100 Contacts**

**MK**

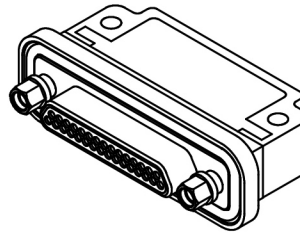

MK-2D2-031-335-260S  
(PLUG)

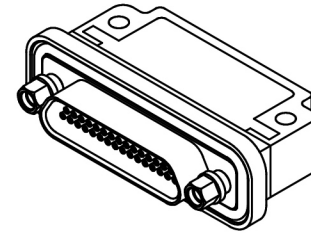

MK-2E2-031-445-260S  
(RECEPTACLE)

MATING MATRIX	
CONNECTOR	MATES WITH
MK-2D...	MK, ML, MM, MN receptacles
MK-2E...	MK, ML, MM, MN plugs

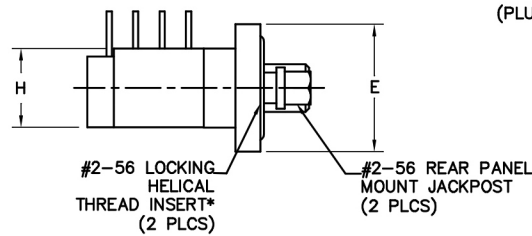
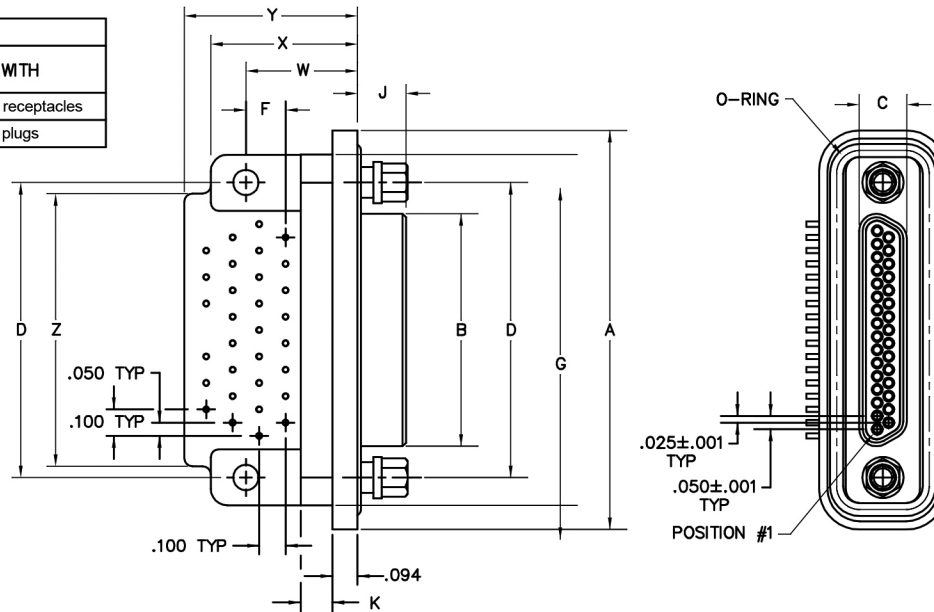

(PLUG SHOWN)

SIZE	CONTACT ROWS	DIMENSIONS															HARDWARE	MOUNTING HOLE				
		A	B		C		D	E	F	G	H	J		K	W	X MAX			Y MAX	Z		
			PLUG MAX	RCPT MAX	PLUG MAX	RCPT MAX						PLUG	RCPT									
9	2	.957	.334	.400	.185	.251	.565	.480	.150	.020	.775	.183	.195	.120	.421	.560	.540	.540	.775			
15		1.107	.484	.550			.715													.925	.660	1.075
21		1.257	.634	.700			.865													1.075	1.175	1.030
25		1.357	.734	.800			.965													1.175	1.325	1.180
31		1.507	.884	.950			1.115													1.325	1.475	1.180
37		1.657	1.034	1.100	1.265	1.475																
51	3	1.657	.984	1.050	.228	.294	1.215	.523	.150	.1425	.341					.550	.770	1.220				
69		1.957	1.284	1.350			1.515													1.725	.870	1.450
100	4	2.383	1.384	1.508	.271	.394	1.800	.600	.200	2.160	.381			.176	.577	.775	1.180	1.810	#4-40 UNC THD	.125 DIA OR #4-40 UNC THREADED INSERT		

\*\* = SHELL ACCEPTS .190 MAX #2-56 SCREW LENGTH (.220 MAX #4-40 SCREW LENGTH).



**PLUG:** MK 2D2-031-335-260S  
**RECEPTACLE:** MK 2E2-031-445-260S  
 XX-XXX-XXX-XXX-XXXX-XXX  
 | BODY | CONTACTS | OPTIONS  
 SERIES SIZE HARDWARE

**PLUG**

**SERIES**

MK .050" Rugged Metal PC Board Mount Connector

**BODY**

- 2 2-Row (Sizes 9 thru 37)
- 3 3-Row (Size 51 & 69)
- 4 4-Row (Size 100)

**BODY STYLE:**

- D Plug, right angle, rear panel mount with fluorosilicone o-ring

**BODY MATERIAL:**

- 2 Electroless nickel shell w/ PPS insulator
- 3 Electrodeposited cadmium shell w/ PPS insulator
- 4 Hard anodized black shell w/ PPS insulator

**SIZE**

XXX 009, 015, 021, 025, 031, 037, 051, 069, 100

**CONTACTS**

**TYPE CONTACTS/TERMINATIONS:**

- 32 Pin, right angle, PCB leads, .109"
- 33 Pin, right angle, PCB leads, .140"
- 34 Pin, right angle, PCB leads, .172"

**PLATING OPTIONS:**

- 3 50 μ" Au contacts
- 5 50 μ" Au contacts; Sn/Pb alloy terminations
- 7 50,μ" Au contacts; SAC305 terminations

**HARDWARE**

**STYLE OF HARDWARE:**

- 00 None
- 24 Two fixed jacknuts, rear panel mount, .040" panel thickness (64\*)
- 26 Two fixed jacknuts, rear panel mount, .060" panel thickness (66\*)
- 28 Two fixed jacknuts, rear panel mount, .070" panel thickness (68\*)
- 29 Two fixed jacknuts, rear panel mount, .080" panel thickness (69\*)

**POLARIZATION:**

- 0S Standard body polarization

**OPTIONS**

- EMI EMI gasket (in lieu of fluorosilicone o-ring)
- OB7 Threaded inserts in mounting holes
- OFW Threaded inserts in mounting holes and EMI gasket (in lieu of fluorosilicone o-ring)

**NOTES**

See page MA-10 for rear panel mounting dimensions.  
See page MA-7 for rear panel hardware dimensions.

\* = Use numbers in parenthesis when ordering size 100.  
 = Option not RoHS compliant

**RECEPTACLE**

**SERIES**

MK .050" Rugged Metal PC Board Mount Connector

**BODY**

- 2 2-Row (Sizes 9 thru 37)
- 3 3-Row (Size 51 & 69)
- 4 4-Row (Size 100)

**BODY STYLE:**

- E Receptacle, right angle, rear panel mount with fluorosilicone o-ring and interfacial seal

**BODY MATERIAL:**

- 2 Electroless nickel shell w/ PPS insulator
- 3 Electrodeposited cadmium shell w/ PPS insulator
- 4 Hard anodized black shell w/ PPS insulator

**SIZE**

XXX 009, 015, 021, 025, 031, 037, 051, 069, 100

**CONTACTS**

**TYPE CONTACTS/TERMINATIONS:**

- 43 Socket, right angle, PCB leads, .109"
- 44 Socket, right angle, PCB leads, .140"
- 45 Socket, right angle, PCB leads, .172"

**PLATING OPTIONS:**

- 3 50 μ" Au contacts
- 5 50 μ" Au contacts; Sn/Pb alloy terminations
- 7 50,μ" Au contacts; SAC305 terminations

**HARDWARE**

**STYLE OF HARDWARE:**

- 00 None
- 24 Two fixed jacknuts, rear panel mount, .040" panel thickness (64\*)
- 26 Two fixed jacknuts, rear panel mount, .060" panel thickness (66\*)
- 28 Two fixed jacknuts, rear panel mount, .070" panel thickness (68\*)
- 29 Two fixed jacknuts, rear panel mount, .080" panel thickness (69\*)

**POLARIZATION:**

- 0S Standard body polarization

**OPTIONS**

- EMI EMI gasket (in lieu of fluorosilicone o-ring)
- OB7 Threaded inserts in mounting holes
- OFW Threaded inserts in mounting holes and EMI gasket (in lieu of fluorosilicone o-ring)

**NOTES**

See page MA-10 for rear panel mounting dimensions.  
See page MA-7 for rear panel hardware dimensions.



# Recommended PC Board Layout

**Right Angle, Narrow Footprint  
Rear Panel Mount  
Standard Polarization**

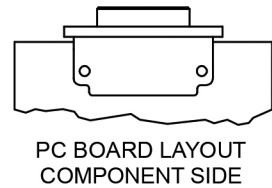
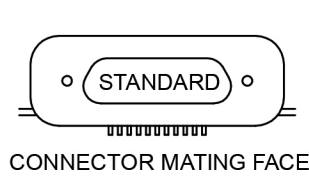
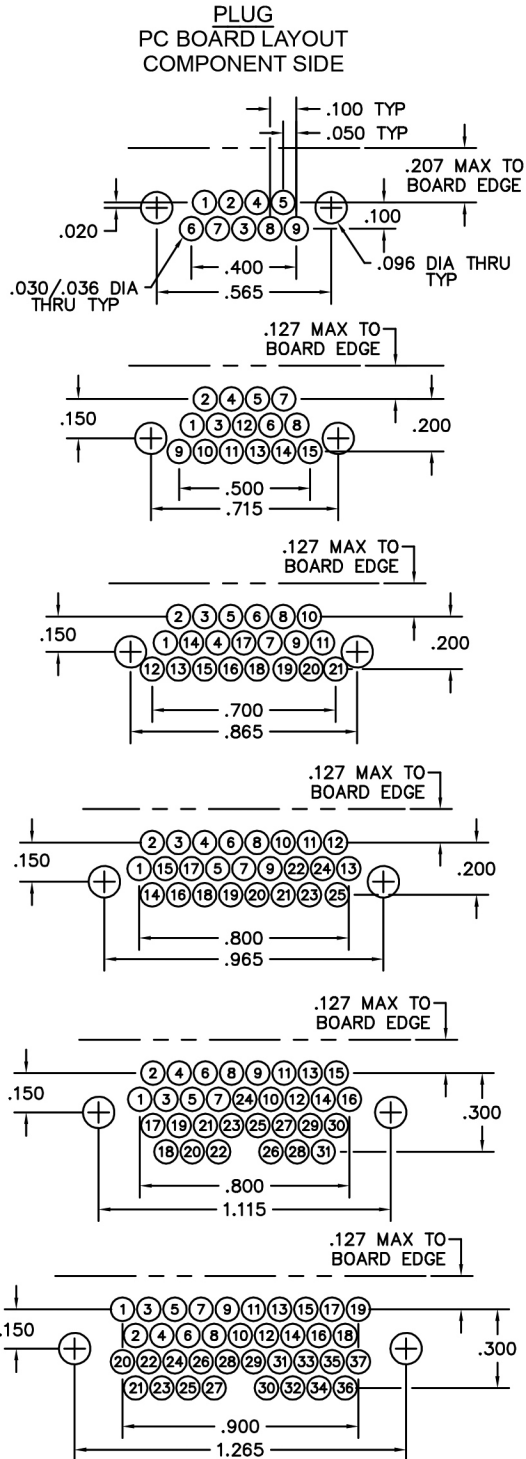

**CONNECTOR  
MATING FACE\*  
(RECEPTACLE)**

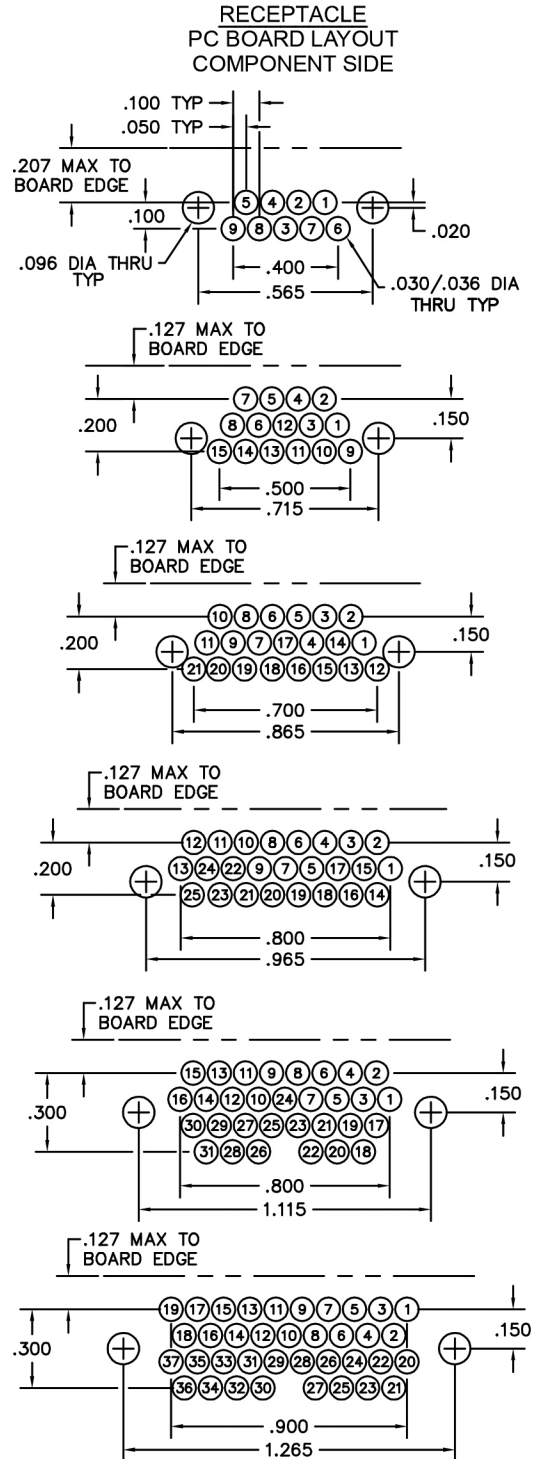
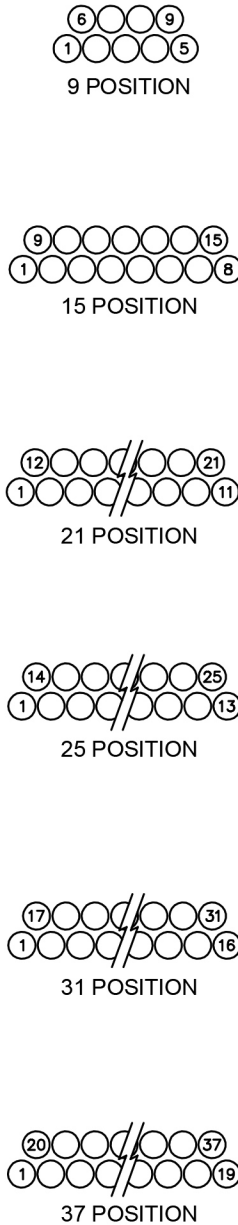

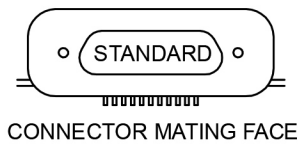

CONNECTOR MATING FACE

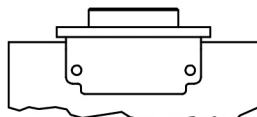

PC BOARD LAYOUT COMPONENT SIDE

## Recommended PC Board Layout

### Right Angle, Narrow Footprint Rear Panel Mount Standard Polarization

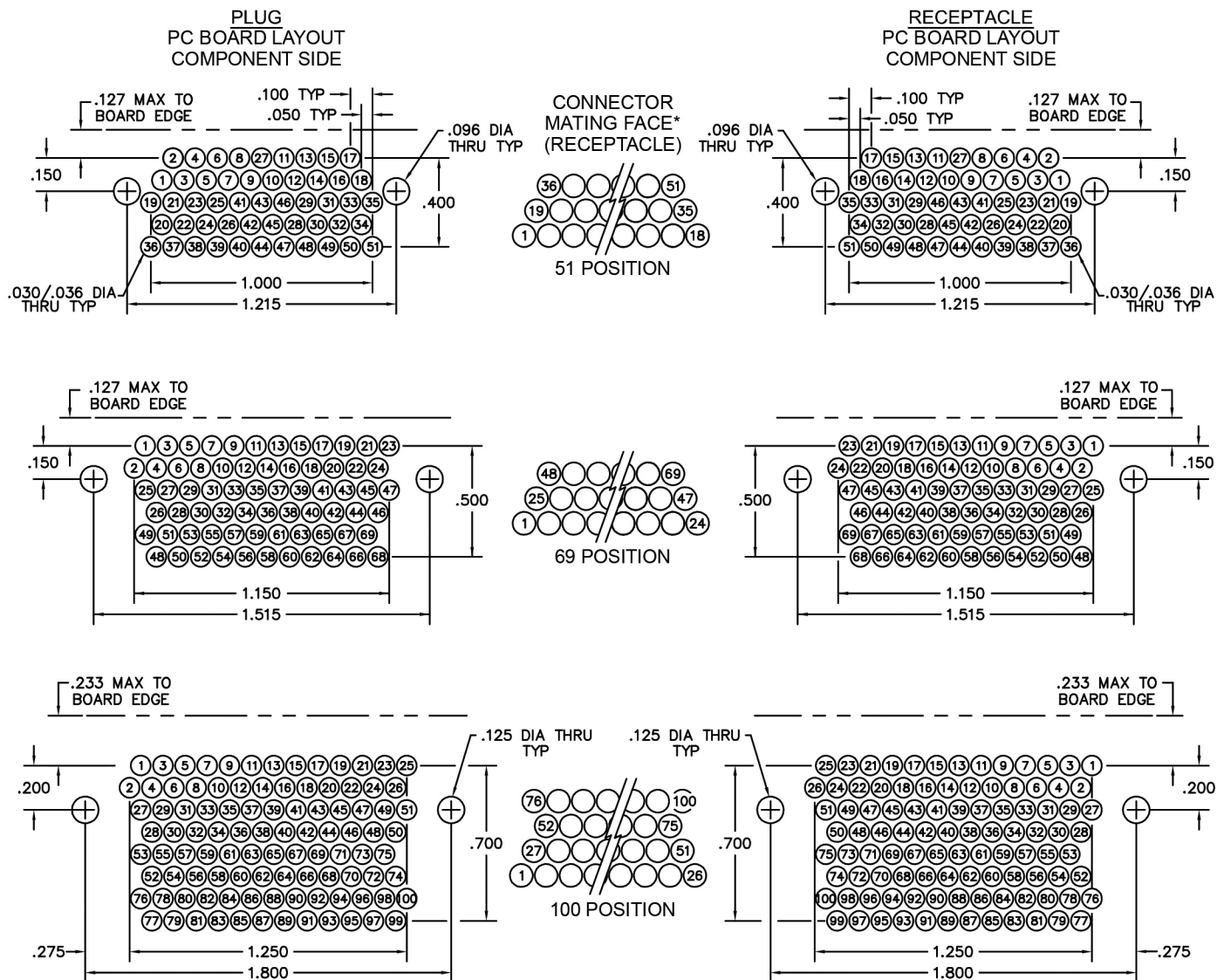

\* For pin (plug) connectors, the contact numbers are reversed left to right.



## Specifications - Sealed Connectors Materials and Finishes \*

<b>Contacts:</b>	Pins: BeCu alloy strip per ASTM B194 Sockets: Brass per ASTM B16 / B16M or ASTM B453 Uninsulated/solid wire tails: Brass per ASTM B16 / B16M or ASTM B453
<b>Contact Finish:</b>	Gold plate per ASTM B488
<b>Shells:</b>	Aluminum Alloy 6061-T6 per SAE AMS-QQ-A-250/11 or 6061-T6511 per SAE AMS-QQ-A-200/8
<b>Aluminum Shell Finishes:</b>	Electroless Nickel per SAE AMS2404, Class 3, 500 $\mu$ " min Electrodeposited Cadmium per SAE AMS-QQ-P-416, Type II, Class 3 Black Anodized per MIL-A-8625, Type III, Class 2
<b>Molded Insulators:</b>	Glass filled polyphenylene sulfide per MIL-M-24519
<b>Embedment:</b>	Frey Engineering Co. insulating compound CF3003-80 and L-II-49 or equivalent
<b>Jackposts:</b>	Corrosion resistant steel per ASTM A320 or ASTM A484 / A484M and ASTM A582 / A582M Passivated per SAE AMS2700
<b>Gaskets:</b>	Interfacial: Fluorosilicone per SAE AMS-R-25988 Flange: Butyl per SAE AMS3238** Internal: EPDM per ASTM D2000**
<b>Tolerances:</b>	Unless otherwise specified: Fractions = $\pm 1/64$ " Decimals = $\pm .010$ " Angles = $\pm 5^\circ$ Wire lengths: insulated/stranded = $+1.0"/-0.0$ " uninsulated/solid = $+0.2"/-0.0$ "

Note: AirBorn can manufacture special configurations for your exact specifications.

\* Reference the above listed specifications or an equivalent industry standard when applicable.

\*\* Chemical compatibility of gasket materials must be considered for each application.

Contact AirBorn for specific application questions.

## Performance

<b>Interface:</b>	Per M83513
<b>Contact Rating:</b>	3-amperes maximum
<b>Solderability:</b>	Terminals (except crimp) tested in accordance with MIL-STD-202, Method 208
<b>Wire Size:</b>	Stranded #24, #26, #28 AWG or solid #25 AWG standard (consult factory for other sizes and types)
<b>Test Voltage:</b>	600 V, RMS, 60 Hz
<b>Operating Temperature:</b>	-55° C to +100° C
<b>Insulation Resistance:</b>	5,000 megohms minimum @ 500 VDC
<b>Durability:</b>	500 connector mating cycles
<b>Vibration:</b>	Tested in accordance with EIA-364-28, Condition IV, according to MIL-83513
<b>Shock:</b>	Tested in accordance with EIA-364-27, Condition E, according to MIL-83513
<b>Salt Spray:</b>	Mated connectors tested in accordance with EIA-364-26, Test Condition B, according to M83513
<b>Humidity:</b>	Mated connectors tested in accordance with EIA-364-31, Method IV (except steps 7a and 7b)
<b>Thermal Shock:</b>	Tested to the temperature extremes of EIA-364-32, Method A, Test Condition I (except step 3, temperature shall be 100° C)
<b>Contact Resistance:</b>	0.065 volt maximum drop @ 2.5 amps (.026 ohms), according to M83513
<b>Contact Engaging Force:</b>	6.0 ounce maximum, with .0221 diameter test sleeve
<b>Contact Separating Force:</b>	0.5 ounce minimum, with .0230 diameter test sleeve
<b>Crimp Strength:</b>	5 pound minimum tensile strength
<b>Sealing:</b>	15 PSI per EIA-364-02 at room temperature, 5 minutes with no visible air leaks, positive pressure from wire (back side) of connector. (Body Styles E & H)  30 PSI per EIA-364-02 at room temperature, 5 minutes with no visible air leaks, positive pressure from wire (back side) of connector. (Body Styles K & L)



# Rugged Metal I/O (Sealed Connector)

.050"  
9 thru 100 Contacts

**MM**

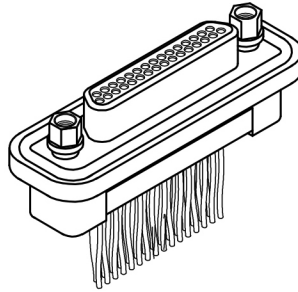

MM-2E2-031-161-26WA  
(PLUG)

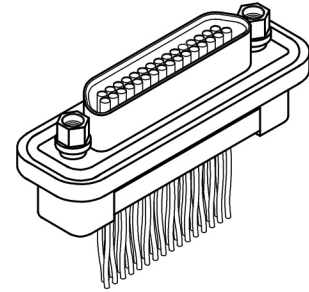

MM-2H2-031-261-26WA  
(RECEPTACLE)

MATING MATRIX	
CONNECTOR	MATES WITH
MM-2E...	MK, ML, MM, MN receptacles
MM-2H...	MK, ML, MM, MN plugs
MM-2K...	MK, ML, MM, MN receptacles
MM-2L...	MK, ML, MM, MN plugs

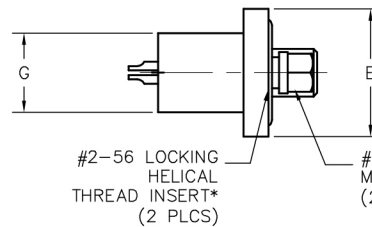
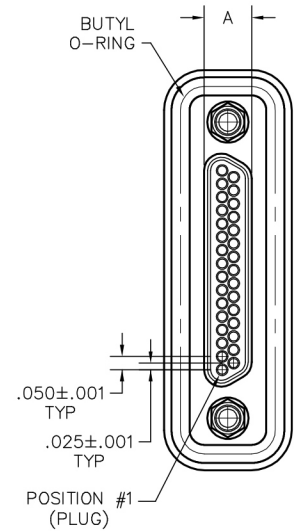
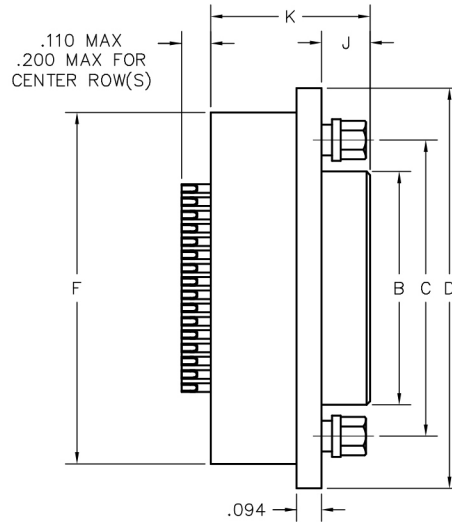
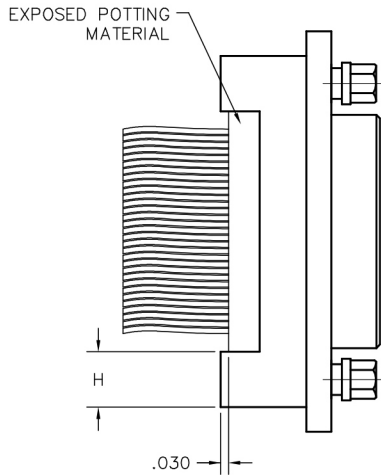

STRANDED WIRE TERMINATION  
(PLUG SHOWN)

SOLDER CUP OR PIGTAIL TERMINATION  
(PLUG WITH SOLDER CUP TERMINATION SHOWN)

DIMENSIONS																
SIZE	CONTACT ROWS	A		B		C	HARDWARE	D	E	F	G	H	J		K	
		PLUG MAX	RCPT MAX	PLUG MAX	RCPT MAX								PLUG	RCPT	PLUG	RCPT
9	2	.185	.251	.334	.400	.565	#2-56 UNC THD	.957	.480	.773	.298	.210	.183	.195	.598	.610
15				.484	.550	.715		1.107		.923						
21				.634	.700	.865		1.257		1.073						
25				.734	.800	.965		1.357		1.173						
31				.884	.950	1.115		1.507		1.323						
37				1.034	1.100	1.265		1.657		1.473						
51	3	.228	.294	.984	1.050	1.215	#4-40 UNC THD	1.657	.523	1.477	.440	.239	.183	.195	.598	.610
69				1.284	1.350	1.515		1.957		1.777						
100	4	.271	.394	1.384	1.508	1.800	#4-40 UNC THD	2.383	.600	2.219	.515	.301	.183	.195	.598	.610

\*\* = SHELL ACCEPTS .200 MAX #2-56 SCREW LENGTH (.295 MAX #4-40 SCREW LENGTH).



PLUG: MM-2E2-031-161-26WA

RECEPTACLE: MM-2H2-031-261-26WA

XX-XXX-XXX-XXX-XXXX  
 SERIES | SIZE | HARDWARE & WIRING  
 BODY CONTACTS

PLUG

**SERIES**

MM .050" Rugged Metal I/O Connector

**BODY**

- 2 2-Row (Sizes 9 thru 37)
- 3 3-Row (Sizes 51 thru 69)
- 4 4-Row (Size 100)

**BODY STYLE:**

- E Plug, straight, rear panel mount.  
Sealed to 15 PSI pressure differential.
- K Plug, straight, rear panel mount.  
Sealed to 30 PSI pressure differential.

**All seal ratings are in the unmated condition**

**BODY MATERIAL:**

- 2 Polyphenylene Sulfide with electroless nickel shell
- 3 Polyphenylene Sulfide with electrodeposited cadmium shell
- 4 Polyphenylene Sulfide with hard anodized black shell

**SIZE**

XXX 009, 015, 021, 025, 031, 037, 051, 069, 100

**CONTACTS**

**TYPE CONTACTS/TERMINATIONS:**

- 11 Pin, straight, solder cup
- 14 Pin, straight, .500" pigtails (.018 dia)
- 16 Pin, straight, stranded wire

**PLATING OPTIONS:**

- 1 50 μ" Au contacts (stranded wire)
- 3 50 μ" Au contacts; Au terminations (solder cup, pigtail)
- 5 50 u" Au contacts; Sn/Pb alloy terminations (pigtail)
- 7 50 u" Au contacts; SAC305 terminations (pigtail)

**HARDWARE & WIRING**

**STYLE OF HARDWARE:**

- 00 None
- 24 Two fixed jacknuts, rear panel mount, .040" panel thickness (64\*)
- 26 Two fixed jacknuts, rear panel mount, .060" panel thickness (66\*)
- 28 Two fixed jacknuts, rear panel mount, .070" panel thickness (68\*)
- 29 Two fixed jacknuts, rear panel mount, .080" panel thickness (69\*)

**WIRING:**

- 00 None (solder cup and pigtail only)
- XX For wiring codes, see page MA-3 & MA-4

**NOTES**

See page MA-10 for rear panel mounting dimensions.  
 See page MA-7 for hardware dimensions.  
 See Product Technical Bulletin #43 for soldering to solder cups.

RECEPTACLE

**SERIES**

MM .050" Rugged Metal I/O Connector

**BODY**

- 2 2-Row (Sizes 9 thru 37)
- 3 3-Row (Sizes 51 thru 69)
- 4 4-Row (Size 100)

**BODY STYLE:**

- H Receptacle, straight, rear panel mount, with fluorosilicone interfacial seal.  
Sealed to 15 PSI pressure differential.
- L Receptacle, straight, rear panel mount, with fluorosilicone interfacial seal.  
Sealed to 30 PSI pressure differential.

**All seal ratings are in the unmated condition**

**BODY MATERIAL:**

- 2 Polyphenylene Sulfide with electroless nickel shell
- 3 Polyphenylene Sulfide with electrodeposited cadmium shell
- 4 Polyphenylene Sulfide with hard anodized black shell

**SIZE**

XXX 009, 015, 021, 025, 031, 037, 051, 069, 100

**CONTACTS**

**TYPE CONTACTS/TERMINATIONS:**

- 21 Socket, straight, solder cup
- 24 Socket, straight, .500" pigtails (.018 dia)
- 26 Socket, straight, crimped wire

**PLATING OPTIONS:**

- 1 50 μ" Au contacts (stranded wire)
- 3 50 μ" Au contacts; Au terminations (solder cup, pigtail)
- 5 50 u" Au contacts; Sn/Pb alloy terminations (pigtail)
- 7 50 u" Au contacts; SAC305 terminations (pigtail)

**HARDWARE & WIRING**

**STYLE OF HARDWARE:**

- 00 None
- 24 Two fixed jacknuts, rear panel mount, .040" panel thickness (64\*)
- 26 Two fixed jacknuts, rear panel mount, .060" panel thickness (66\*)
- 28 Two fixed jacknuts, rear panel mount, .070" panel thickness (68\*)
- 29 Two fixed jacknuts, rear panel mount, .080" panel thickness (69\*)

**WIRING:**

- 00 None (solder cup and pigtail only)
- XX For wiring codes, see page MA-3 & MA-4

**NOTES**

See page MA-10 for rear panel mounting dimensions.  
 See page MA-7 for hardware dimensions.  
 See Product Technical Bulletin #43 for soldering to solder cups.

\* = Use numbers or letters in parenthesis when ordering size 100.

= Option not RoHS compliant



# Cable to Cable (1 Row)

**.050"**  
**4 thru 25 Contacts**

**MM**

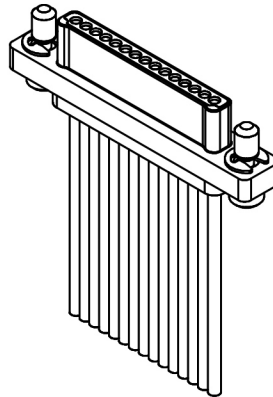

MM-112-015-161-41WQ  
(PLUG)

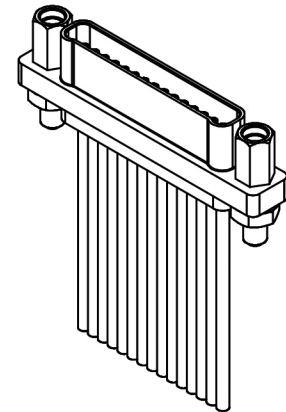

MM-122-015-261-22WQ  
(RECEPTACLE)

MATING MATRIX	
CONNECTOR	MATES WITH
MM-11...	MM-12, MK-16, MK-18 receptacles
MM-12...	MM-11, MK-15, MK-17 plugs

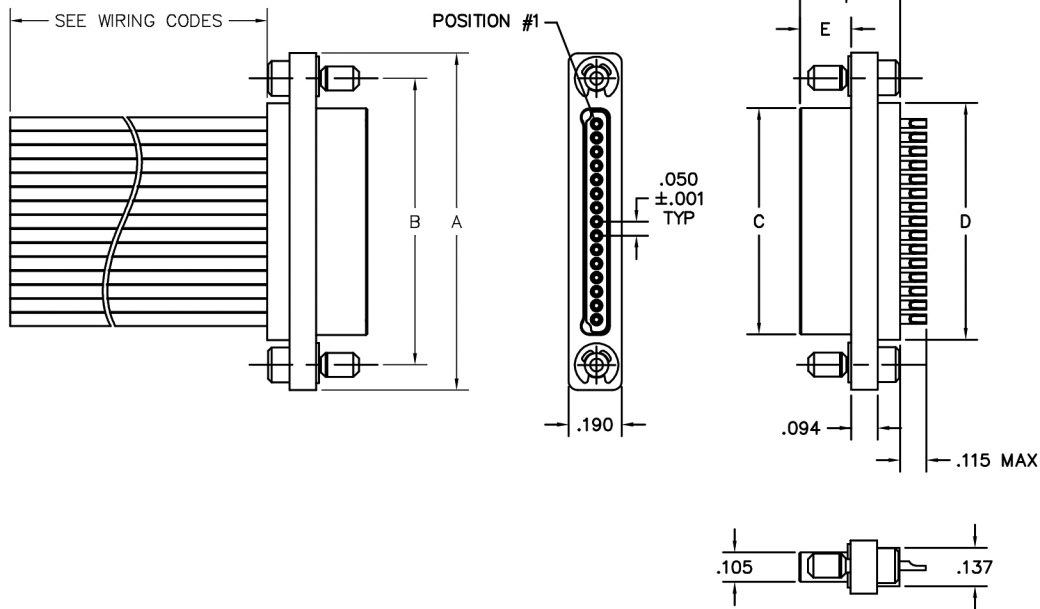

PLUG SHOWN

SIZE	DIMENSIONS								HARDWARE	
	A	B	C		D	E		F		
			PLUG MAX	RCPT MAX		PLUG MAX	RCPT MAX	PLUG MAX		RCPT MAX
4	.655	.475	.260	.297	.297	.186	.198	.358	.370	#2-56 UNC THD (Ø.092 THRU)
5	.705	.525	.310	.347	.347					
6	.755	.575	.360	.397	.397					
9	.905	.725	.510	.547	.547					
12	1.055	.875	.660	.697	.697					
15	1.205	1.025	.810	.847	.847					
21	1.505	1.325	1.110	1.147	1.147					
25	1.705	1.525	1.310	1.347	1.347					



**PLUG:** MM-112-006-113-2200  
**RECEPTACLE:** MM-122-006-2A3-4100  
 XX-XXX-XXX-XXX-XXXX-XXX  
 |     |     |     |     |  
 BODY CONTACTS OPTIONS  
 SERIES   SIZE   HARDWARE

**PLUG**

**RECEPTACLE**

**SERIES**

MM .050" Rugged Metal I/O Connector  
(MM mates to MK & MM)

**SERIES**

MM .050" Rugged Metal I/O Connector  
(MM mates to MK & MM)

**BODY**

- 1 1-Row (Sizes 4 thru 25)
- BODY STYLE:
- 1 Plug, straight
- BODY MATERIAL:
- 2 Electroless nickel shell w/ PPS insert
- 3 Electrodeposited cadmium shell w/ PPS insert
- 5 Stainless Steel shell w/ PPS insert
- A Pure Electro-Deposited Aluminum
- K Zinc Nickel Plating
- T Nickel Polymer Plating

**BODY**

- 1 1-Row (Sizes 4 thru 25)
- BODY STYLE:
- 2 Receptacle, straight
- BODY MATERIAL:
- 2 Electroless nickel shell w/ PPS insert
- 3 Electrodeposited cadmium shell w/ PPS insert
- 5 Stainless Steel shell w/ PPS insert
- A Pure Electro-Deposited Aluminum
- K Zinc Nickel Plating
- T Nickel Polymer Plating

**SIZE**

XXX 004, 005, 006, 009, 012, 015, 021, 025

**SIZE**

XXX 004, 005, 006, 009, 012, 015, 021, 025

**CONTACTS**

- TYPE CONTACTS/TERMINATIONS:
- 11 Pin, straight, 26 awg solder cup
  - 1A Pin, straight, 24 awg solder cup
  - 12 Pin, straight, 0.150" pigtails (.018 dia)
  - 13 Pin, straight, 0.250" pigtails (.018 dia)
  - 14 Pin, straight, 0.500" pigtails (.018 dia)
  - 16 Pin, straight, crimped wire
- PLATING OPTIONS:
- 1 50 u" Au contacts (Crimped Wire)
  - 3 50 u" Au contacts; Au terminations (solder cup, pigtail)
  - 5 50 u" Au contacts; Sn/Pb alloy terminations (pigtail)
  - 7 50 u" Au contacts; SAC305 terminations (pigtail)

**CONTACTS**

- TYPE CONTACTS/TERMINATIONS:
- 21 Skt, straight, 26 awg solder cup
  - 2A Skt, straight, 24 awg solder cup
  - 22 Skt, straight, 0.150" pigtails (.018 dia)
  - 23 Skt, straight, 0.250" pigtails (.018 dia)
  - 24 Skt, straight, 0.500" pigtails (.018 dia)
  - 26 Skt, straight, crimped wire
- PLATING OPTIONS:
- 1 50 u" Au contacts (Crimped Wire)
  - 3 50 u" Au contacts; Au terminations (solder cup, pigtail)
  - 5 50 u" Au contacts; Sn/Pb alloy terminations (pigtail)
  - 7 50 u" Au contacts; SAC305 terminations (pigtail)

**HARDWARE**

- STYLE OF HARDWARE:
- 00 None
  - 22 Two fixed jacknut assemblies
  - 41 Two turning jackscrews, allen head, retaining ring
  - 45 Two turning jackscrews, allen head, captivated\*\*

**HARDWARE**

- STYLE OF HARDWARE:
- 00 None
  - 22 Two fixed jacknut assemblies
  - 41 Two turning jackscrews, allen head, retaining ring
  - 45 Two turning jackscrews, allen head, captivated\*\*

**WIRING**

XX For wiring codes, see page MA-3 & MA-4

**WIRING**

XX For wiring codes, see page MA-3 & MA-4

**OPTIONS**

900 Interfacial Seal

\*\* = Captive hardware is factory installed and non-removable.  
 = Option not RoHS compliant



# Right Angle Boardmount (1 Row)

**.050"**  
**4 thru 25 Contacts**

**MK**

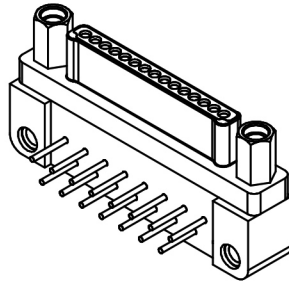

MK-152-015-325-220S  
(PLUG)

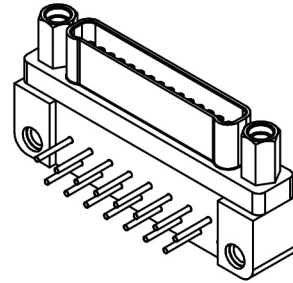

MK-162-015-435-220S  
(RECEPTACLE)

MATING MATRIX	
CONNECTOR	MATES WITH
MK-15...	MM-12, MK-18 receptacles
MK-16...	MM-11, MK-17 plugs

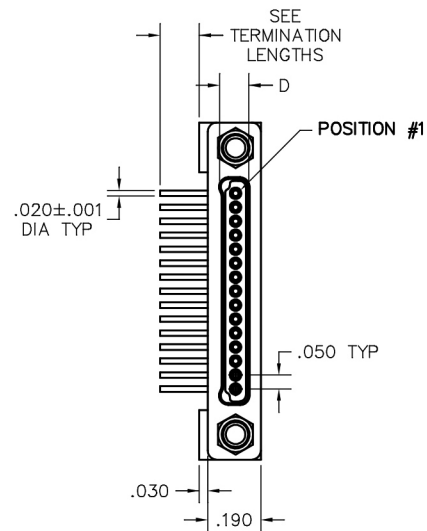
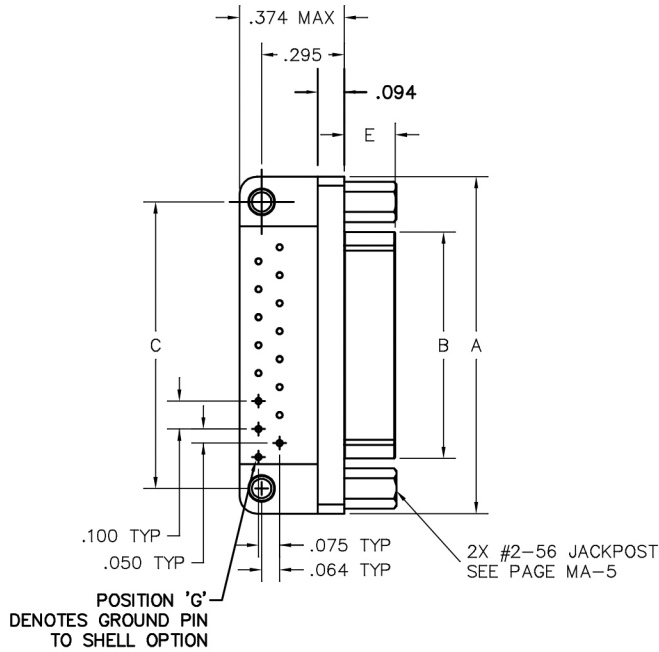

PLUG SHOWN

SIZE	DIMENSIONS								MOUNTING HOLE
	A	B		C	D		E		
		PLUG MAX	RCPT MAX		PLUG MAX	RCPT MAX	PLUG MAX	RCPT MAX	
4	.655	.260	.297	.475	.110	.142	.186	.198	#2-56 CLEARANCE THRU OR #2-56 UNC THREADED INSERT
5	.705	.310	.347	.525					
6	.755	.360	.397	.575					
9	.905	.510	.547	.725					
12	1.055	.660	.697	.875					
15	1.205	.810	.847	1.025					
21	1.505	1.110	1.147	1.325					
25	1.705	1.310	1.347	1.525					



**PLUG:** MK-152-006-325-220S  
**RECEPTACLE:** MK-162-006-425-220S  
XX-XXX-XXX-XXX-XXXX-XXX  
 |       |       |       |  
 BODY CONTACTS OPTIONS  
 SERIES       SIZE       HARDWARE

**PLUG**

**SERIES**

MK .050" Rugged Metal Right Angle PTH Connector  
(MK mates to MK & MM)

**BODY**

- 1 1-Row (Sizes 4 thru 25)  
   BODY STYLE:  
 5 Plug, right angle, standard footprint, with mounting holes  
   BODY MATERIAL:  
 2 Electroless nickel shell w/ PPS insert  
 3 Electrodeposited cadmium shell w/ PPS insert   
 5 Stainless Steel shell w/ PPS insert  
 A Pure Electro-Deposited Aluminum  
 K Zinc Nickel Plating  
 T Nickel Polymer Plating

**SIZE**

XXX 004, 005, 006, 009, 012, 015, 021, 025

**CONTACTS**

- TYPE CONTACTS/TERMINATIONS:  
 32 Pin, right angle, pcb leads, .109"  
 33 Pin, right angle, pcb leads, .140"  
 34 Pin, right angle, pcb leads, .172"  
 A2 Pin, right angle, pcb leads, .109" w/ ground pin option  
 A3 Pin, right angle, pcb leads, .140" w/ ground pin option  
 A4 Pin, right angle, pcb leads, .172" w/ ground pin option  
 PLATING OPTIONS:  
 3 50 u" Au contacts; Au terminations  
 5 50 u" Au contacts; Sn/Pb alloy terminations   
 7 50 u" Au contacts; SAC305 terminations

**HARDWARE**

- STYLE OF HARDWARE:  
 00 None  
 22 Two fixed jacknut assemblies  
 POLARIZATION:  
 0S Standard body polarization

**OPTIONS**

- 0B7 Threaded inserts, standard body polarization
- 900 Interfacial Seal
- 0B7 Threaded inserts and interfacial sealing gasket, standard body polarization

= Option not RoHS compliant

**RECEPTACLE**

**SERIES**

MK .050" Rugged Metal Right Angle PTH Connector  
(MM mates to MK & MM)

**BODY**

- 1 1-Row (Sizes 4 thru 25)  
   BODY STYLE:  
 6 Receptacle, right angle, standard footprint, with mounting holes  
   BODY MATERIAL:  
 2 Electroless nickel shell w/ PPS insert  
 3 Electrodeposited cadmium shell w/ PPS insert   
 5 Stainless Steel shell w/ PPS insert  
 A Pure Electro-Deposited Aluminum  
 K Zinc Nickel Plating  
 T Nickel Polymer Plating

**SIZE**

XXX 004, 005, 006, 009, 012, 015, 021, 025

**CONTACTS**

- TYPE CONTACTS/TERMINATIONS:  
 43 Socket, right angle, pcb leads, .109"  
 44 Socket, right angle, pcb leads, .140"  
 45 Socket, right angle, pcb leads, .172"  
 B3 Socket, right angle, pcb leads, .109" w/ ground pin option  
 B4 Socket, right angle, pcb leads, .140" w/ ground pin option  
 B5 Socket, right angle, pcb leads, .172" w/ ground pin option  
 PLATING OPTIONS:  
 3 50 u" Au contacts; Au terminations  
 5 50 u" Au contacts; Sn/Pb alloy terminations   
 7 50 u" Au contacts; SAC305 terminations

**HARDWARE**

- STYLE OF HARDWARE:  
 00 None  
 22 Two fixed jacknut assemblies  
 POLARIZATION:  
 0S Standard body polarization

## Recommended PC Board Layout

RIGHT ANGLE  
Standard Polarization  
Pos 4 thru 9

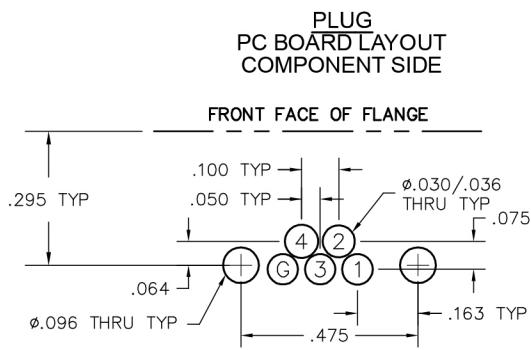
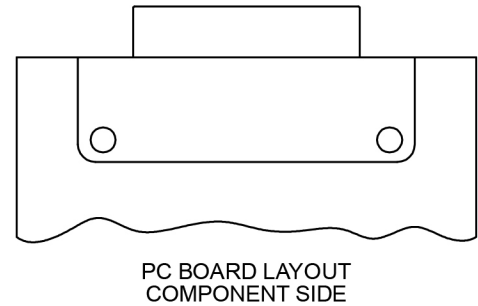
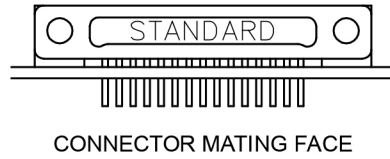

CONNECTOR  
MATING FACE\*  
(RECEPTACLE)

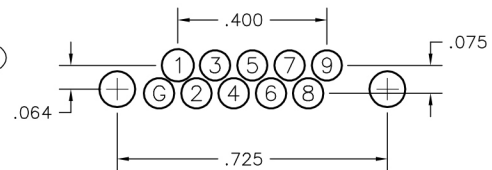
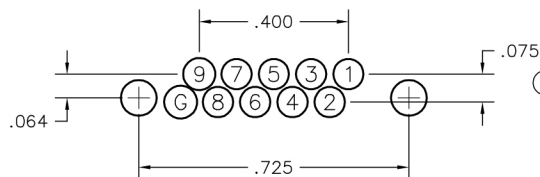
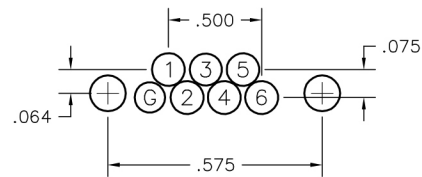
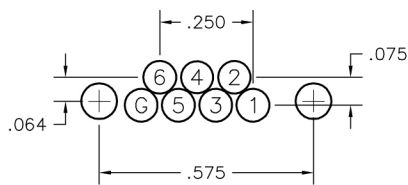
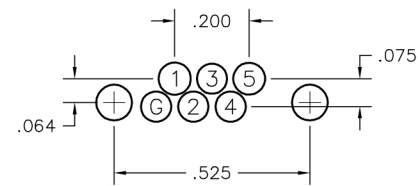
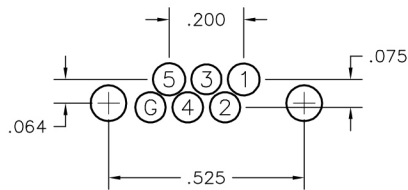
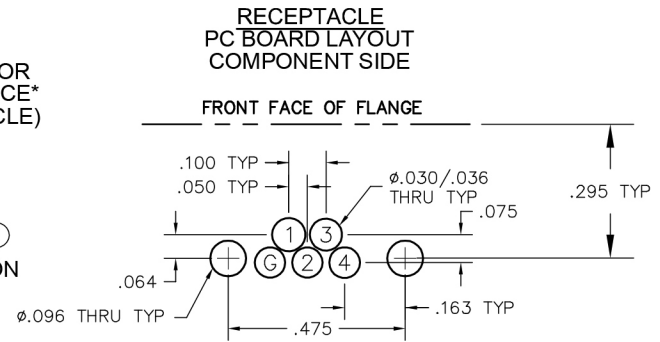

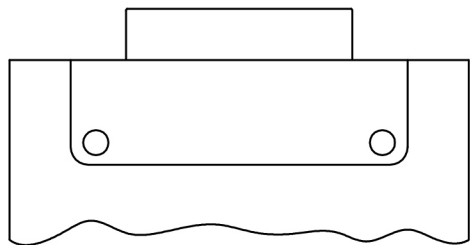

PC BOARD LAYOUT  
COMPONENT SIDE



CONNECTOR MATING FACE

## Recommended PC Board Layout

RIGHT ANGLE  
Standard Polarization  
Pos 12 thru 25

RECEPTACLE  
PC BOARD LAYOUT  
COMPONENT SIDE

FRONT FACE OF FLANGE

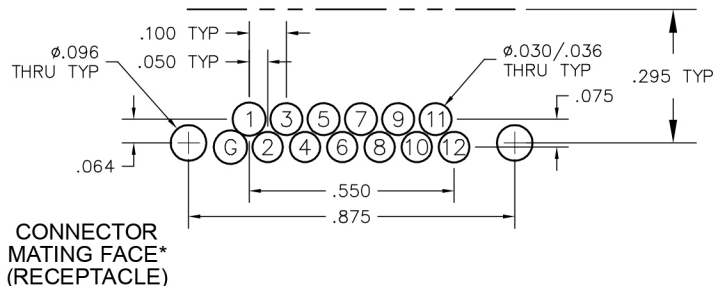

CONNECTOR MATING FACE\*  
(RECEPTACLE)



12 POSITION

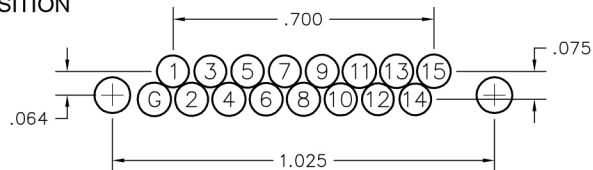
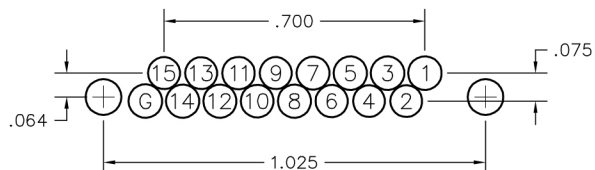
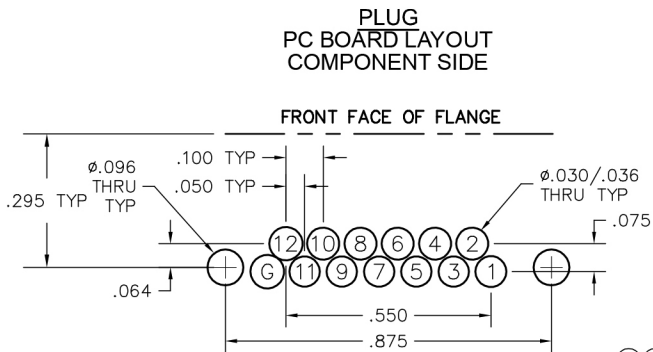

15 POSITION

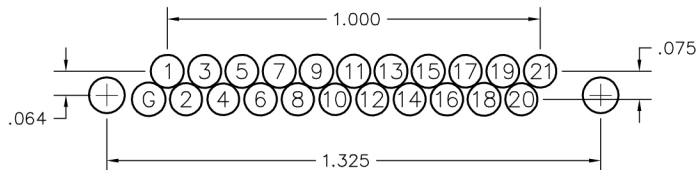
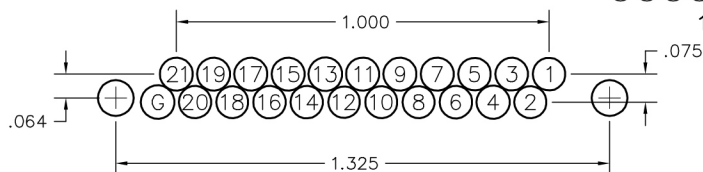

21 POSITION

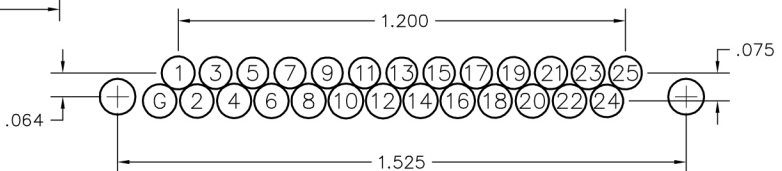
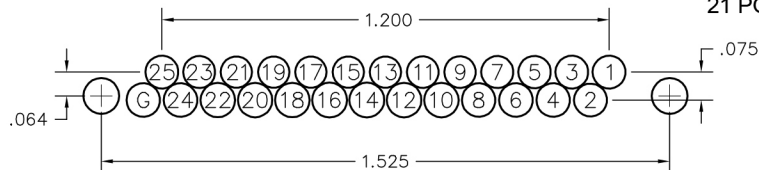

25 POSITION



# Horizontal Surface Mount (1 Row)

**.050"**  
**4 thru 25 Contacts**

**MK**

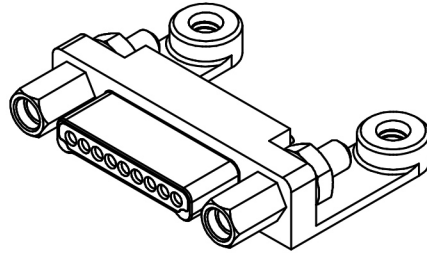

MK-172-009-175-220S  
(PLUG)

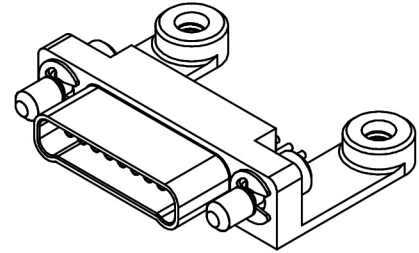

MK-182-009-275-410S  
(RECEPTACLE)

MATING MATRIX	
CONNECTOR	MATES WITH
MK-17...	MM-12, MK-18 receptacles
MK-18...	MM-11, MK-17 plugs

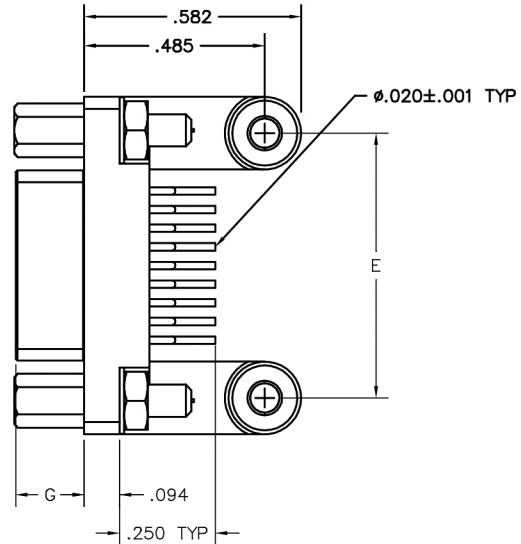
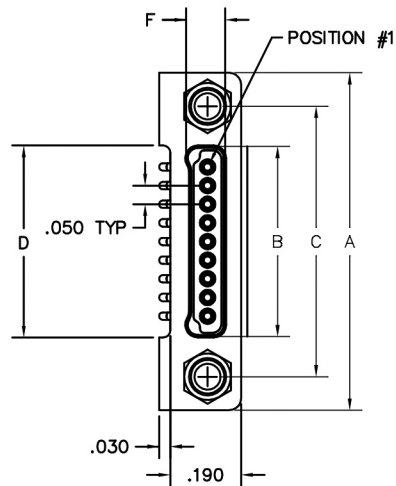

2X #2-56 JACKPOST  
SEE PAGE MA-5

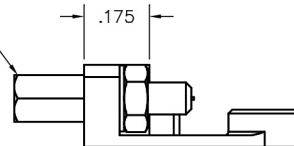

PLUG SHOWN

SIZE	DIMENSIONS										
	A	B		C	D	E	F		G		MOUNTING HOLE
		PLUG MAX	RCPT MAX				PLUG MAX	RCPT MAX	PLUG MAX	RCPT MAX	
4	.655	.260	.297	.475	.265	.460					#2-56 THREAD THRU
5	.705	.310	.347	.525	.315	.510					
6	.755	.360	.397	.575	.365	.560					
9	.905	.510	.547	.725	.515	.710	.110	.142	.186	.198	
12	1.055	.660	.697	.875	.665	.860					
15	1.205	.810	.847	1.025	.815	1.010					
21	1.505	1.110	1.147	1.325	1.115	1.310					
25	1.705	1.310	1.347	1.525	1.315	1.510					



**PLUG:** MK-172-006-175-220S  
**RECEPTACLE:** MK-182-006-275-410S  
XX-XXX-XXX-XXX-XXXX-XXX  
 |    |    |    |    |  
 BODY CONTACTS OPTIONS  
 SERIES    SIZE    HARDWARE

**PLUG**

**SERIES**

MK .050" Rugged Metal Horizontal SMT Connector  
(MK mates to MK & MM)

**BODY**

- 1 1-Row (Sizes 4 thru 25)  
  BODY STYLE:  
7 Plug, Horizontal SMT  
  BODY MATERIAL:  
2 Electroless nickel shell w/ PPS insert  
3 Electrodeposited cadmium shell w/ PPS insert
- 5 Stainless Steel shell w/ PPS insert  
A Pure Electro-Deposited Aluminum  
K Zinc Nickel Plating  
T Nickel Polymer Plating

**SIZE**

XXX 004, 005, 006, 009, 012, 015, 021, 025

**CONTACTS**

- TYPE CONTACTS/TERMINATIONS:  
17 Pin, surface mount  
PLATING OPTIONS:  
3 50 u" Au contacts; Au terminations  
5 50 u" Au contacts; Sn/Pb alloy terminations
- 7 50 u" Au contacts; SAC305 terminations

**HARDWARE**

- STYLE OF HARDWARE:  
00 None  
22 Two fixed jacknut assemblies  
41 Two turning jackscrews, allen head, retaining ring  
POLARIZATION:  
0S Standard body polarization

**OPTIONS**

= Option not RoHS compliant

**RECEPTACLE**

**SERIES**

MK .050" Rugged Metal Horizontal SMT Connector  
(MK mates to MK & MM)

**BODY**

- 1 1-Row (Sizes 4 thru 25)  
  BODY STYLE:  
8 Receptacle, Horizontal SMT  
  BODY MATERIAL:  
2 Electroless nickel shell w/ PPS insert  
3 Electrodeposited cadmium shell w/ PPS insert
- 5 Stainless Steel shell w/ PPS insert  
A Pure Electro-Deposited Aluminum  
K Zinc Nickel Plating  
T Nickel Polymer Plating

**SIZE**

XXX 004, 005, 006, 009, 012, 015, 021, 025

**CONTACTS**

- TYPE CONTACTS/TERMINATIONS:  
27 Socket, surface mount  
PLATING OPTIONS:  
3 50 u" Au contacts; Au terminations  
5 50 u" Au contacts; Sn/Pb alloy terminations
- 7 50 u" Au contacts; SAC305 terminations

**HARDWARE**

- STYLE OF HARDWARE:  
00 None  
22 Two fixed jacknut assemblies  
41 Two turning jackscrews, allen head, retaining ring  
POLARIZATION:  
0S Standard body polarization

900 Interfacial Seal



# Recommended PC Board Layout

Horizontal SMT  
1 ROW  
Pos 4 thru 9



CONNECTOR MATING FACE

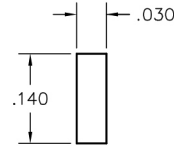

FOOTPRINT/PAD CONFIGURATION

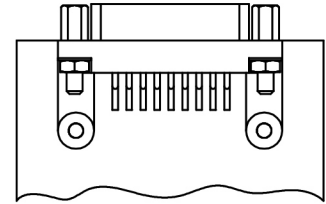

PC BOARD LAYOUT COMPONENT SIDE

PLUG  
PC BOARD LAYOUT COMPONENT SIDE

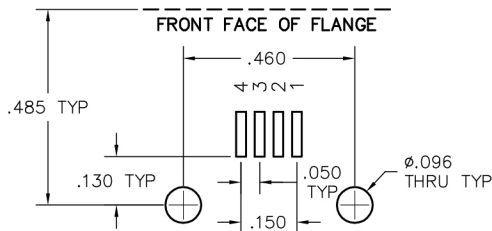

CONNECTOR MATING FACE\* (RECEPTACLE)



RECEPTACLE  
PC BOARD LAYOUT COMPONENT SIDE

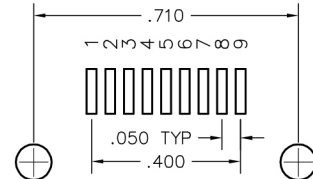
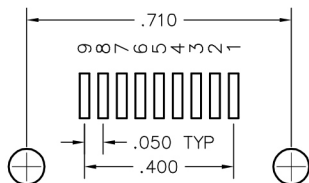
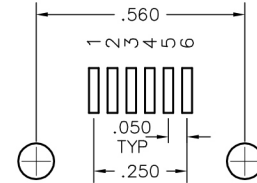
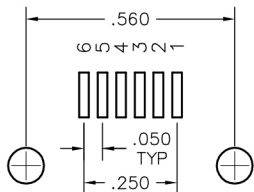
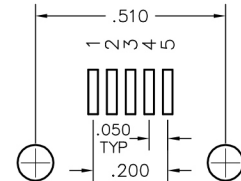
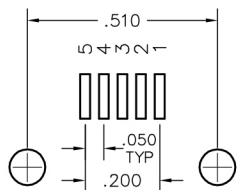
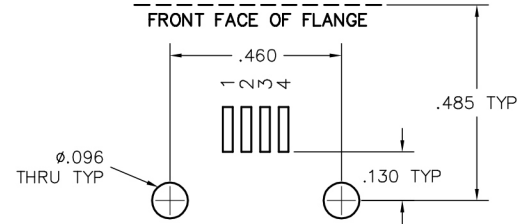

# Recommended PC Board Layout

Horizontal SMT  
1 ROW  
Pos 12 thru 25



CONNECTOR MATING FACE

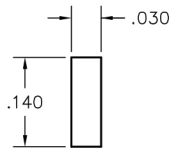

FOOTPRINT/PAD CONFIGURATION

PLUG  
PC BOARD LAYOUT  
COMPONENT SIDE

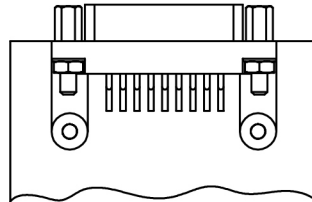

PC BOARD LAYOUT  
COMPONENT SIDE

RECEPTACLE  
PC BOARD LAYOUT  
COMPONENT SIDE

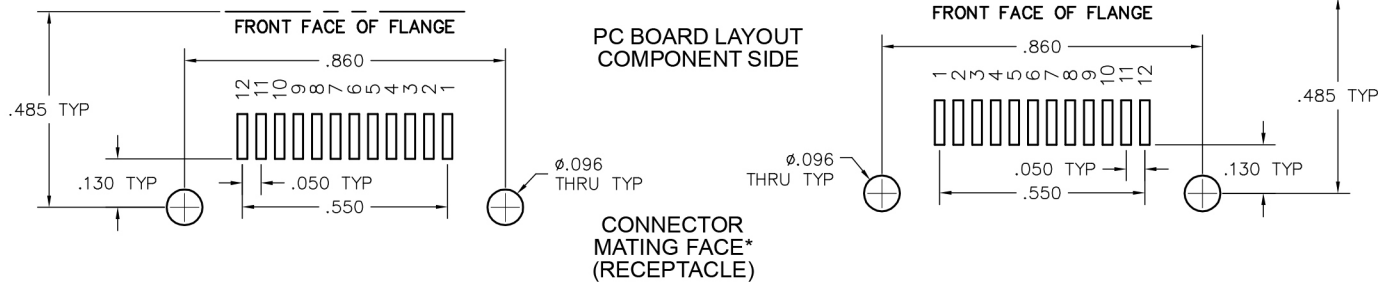

CONNECTOR  
MATING FACE\*  
(RECEPTACLE)

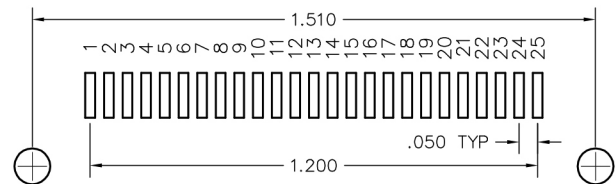
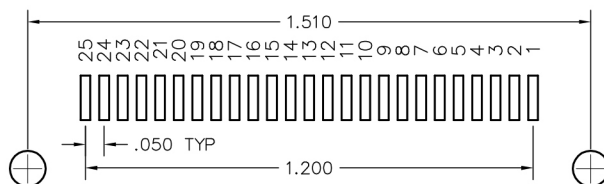
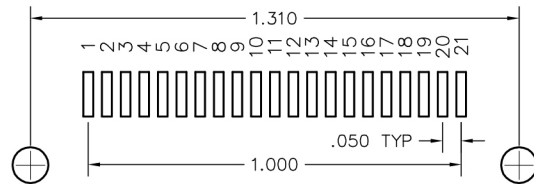
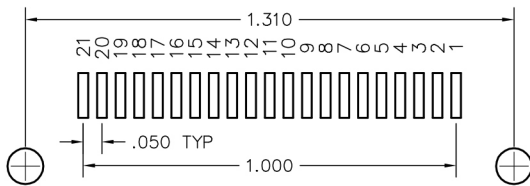
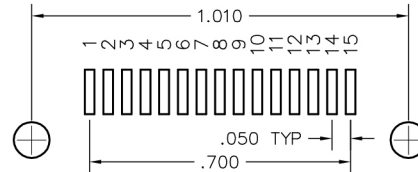
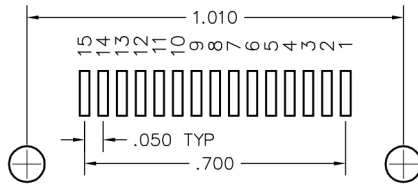



**"MHT" SERIES - .050"**  
**High Temperature**



# Contents

## "MHT" Series

### .050" Microminiature PCB and I/O Connectors, High Temperature

MHT-1	Contents
MHT-2	Specifications
MHT-3	Performance
MHT-4	Part number description
<b>Micro-D, High Temperature, Cable to Cable Connectors (Metal)</b>	
MHT-5	MMHT - MMHT Rugged
MHT-7	MQHT - MQHT Low profile
<b>Micro-D, High Temperature, Board to Cable Connectors (Metal)</b>	
MHT-9, 11	MKHT - MMHT Rugged right angle, narrow footprint
MHT-13	MKHT Board layouts - right angle, narrow footprint
MHT-15, 17	MSHT - MQHT Low profile right angle, narrow footprint
MHT-19	MSHT Board layouts - right angle, narrow footprint
MHT-21	MTHT - MTHT Low Profile right angle, radius, four mounting holes
MHT-23	MTHT Board layouts - right angle, radius, four mounting holes

## Specifications

### Materials and Finishes \*

<b>Contacts:</b>	Pins: Copper based alloy selected for high temperature applications Sockets: Brass per ASTM B121 / B121M or ASTM B16 / B16M or ASTM B453
<b>Contact Finish:</b>	Gold plate per ASTM B488
<b>Shells:</b>	Aluminum Alloy 6061-T6 per SAE AMS-QQ-A-250/11 or 6061-T6511 per SAE AMS-QQ-A-200/8 Electroless Nickel per SAE AMS2404, Class 3, 500 $\mu$ " min
<b>Molded Insulators:</b>	High temperature thermoplastic
<b>Embedment:</b>	High temperature epoxy
<b>Jackscrews, Jackposts and Nuts:</b>	Corrosion resistant steel per ASTM A320 or ASTM A484 / A484M and ASTM A582 / A582M Passivated per SAE AMS2700
<b>Clips and Washers:</b>	Corrosion resistant steel per ASME 18.24 or NASM35333 (For reference only: ASME 18.24 CRS per ASTM A693 and NASM35333 CRS per ASTM A240) Passivated per ASME 18.24 or NASM35333 (For reference only: ASME 18.24 and NASM35333 passivated per SAE AMS2700)
<b>Interfacial Seal Gaskets:</b>	Fluorosilicone per SAE AMS-R-25988
<b>Tolerances:</b>	Unless otherwise specified: Fractions = $\pm 1/64$ " Decimals = $\pm 0.010$ " Angles = $\pm 5^\circ$ Wire lengths: insulated/stranded = $+1.0"/-0.0$ " uninsulated/solid = $+0.2"/-0.0$ "

Note: AirBorn can manufacture special configurations for your exact specifications.

\* = Reference the above listed specifications or an equivalent industry standard when applicable



## Performance Reference MIL-DTL-83513

AirBorn "M" Series meets or exceeds MIL-DTL-83513 Performance Specifications

<b>Contact Rating:</b>	3-amperes maximum
<b>Solderability:</b>	Terminals (except crimp) tested in accordance with MIL-STD-202, Method 208
<b>Wire Size:</b>	Stranded #24, #26, #28 AWG or solid #25 AWG standard (consult factory for other sizes and types)
<b>Test Voltage:</b>	600 V, RMS, 60 Hz
<b>Operating Temperature:</b>	-55° C to +205° C
<b>Insulation Resistance:</b>	5,000 megohms minimum @ 500 VDC
<b>Durability:</b>	500 connector mating cycles
<b>Salt Spray:</b>	Mated connectors tested in accordance with MIL-STD-1344, Method 1001, Test Condition B
<b>Humidity:</b>	Mated connectors tested in accordance with MIL-STD-1344, Method 1002, Type II (except steps 7a and 7b)
<b>Thermal Shock:</b>	Tested to the temperature extremes of MIL-STD-1344, Method 1003, Test Condition A (except step 3, temperature shall be 205° C)
<b>Contact Resistance:</b>	0.065 volt maximum drop @ 2.5 amps (.026 ohms)
<b>Contact Engaging Force:</b>	6.0 ounce maximum, with .0221 diameter test sleeve
<b>Contact Separating Force:</b>	0.5 ounce minimum, with .0230 diameter test sleeve
<b>Crimp Strength:</b>	5 pound minimum tensile strength

## Part Number Description

Each part number consists of at least five elements: series, body description, size (number of contacts), type of contacts, and type of hardware. A sixth element is added whenever special modifications or options are available.

Each catalog page shows the choices available for each of these elements. By selecting one option from each category on the page, you can build a set of connectors to meet your requirements.

Each element is identified by a combination of letters and/or numbers in fixed field lengths, and separated by a hyphen (-). Each space must be filled in to complete the number. When the size, for example, is less than 100, indicate as 009, 051, etc.

### **Series:**

This will always be a four letter designator which will identify the connector series. All .050" connectors begin with the letter "M". The second letter designates the various styles of .050" connectors. "HT" designates high temperature.

### **Body:**

Each digit of the Body Designator will normally identify (1) the number of rows, (2) the style of body, and (3) the body materials. The three digit number to identify the body consists of one digit from each group.

### **Size:**

The size is determined by the number of contacts in the connector, and is an integral part of the part number. Order only sizes shown on the catalog page unless otherwise noted.

### **Contacts:**

Each page also identifies all contact options for a given connector. The first two digits designate the type of contacts and terminations; the third digit designates the plating option.

### **Hardware:**

The hardware designator is four digits; two for style of hardware and two for polarization or wiring instruction. Follow the choices for each connector.

### **Special Instructions (Options):**

Special instructions are referenced by a three digit number added to the end of the part number. The last three digits are included only when applicable. AirBorn will provide individual code numbers as needed.

### **Note:**

Each page is as comprehensive as possible. However, if you do not find a particular connector size or option, please contact the factory for further assistance.



**Cable to Cable**  
**.050"**  
**9 thru 100 Contacts**  
**Rugged Metal**  
**High Temperature**

**MMHT**

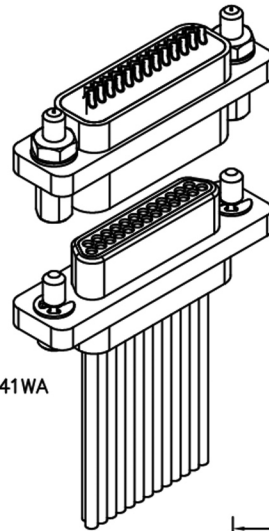

MMHT-223-025-2A3-2200  
(METAL)

MMHT-212-025-161-41WA  
(METAL)

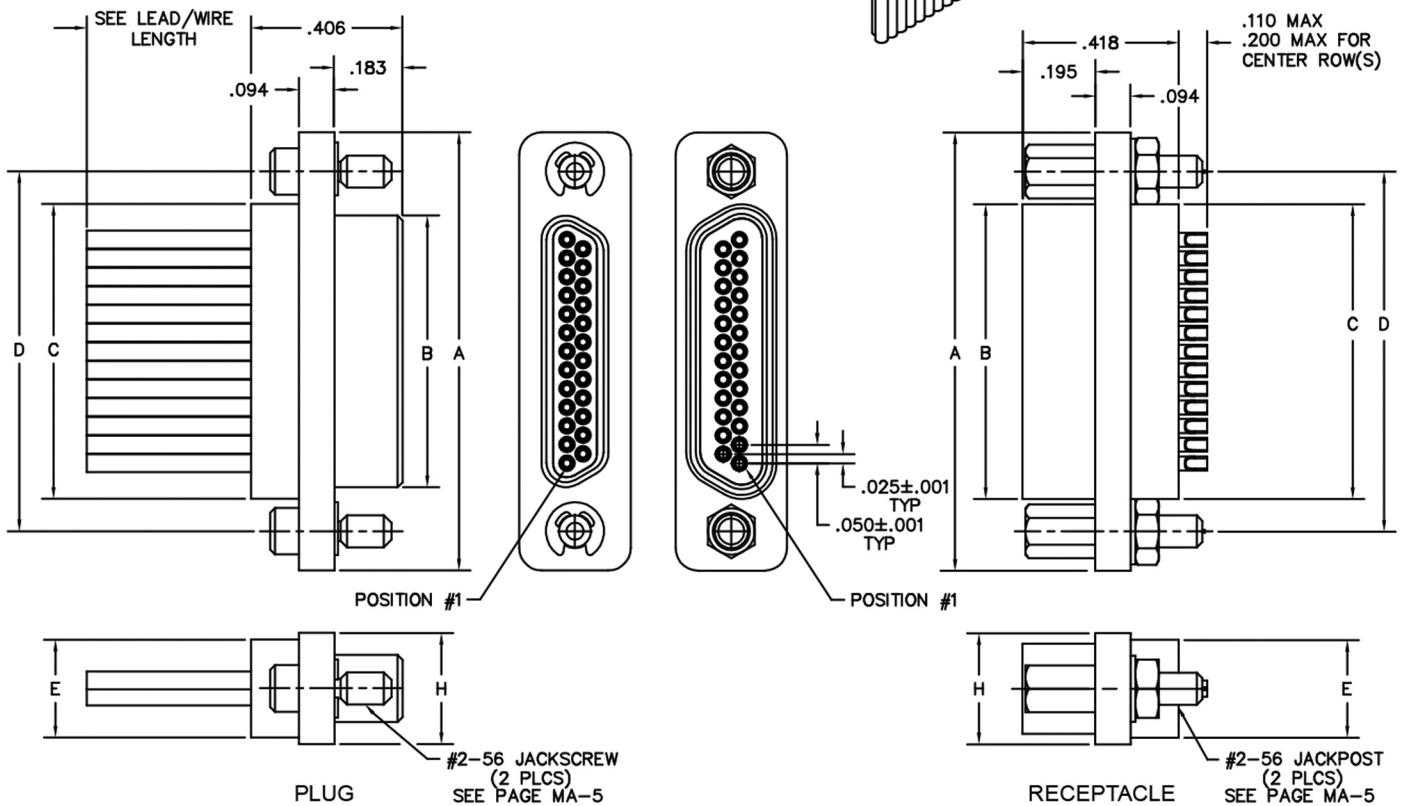

SIZE	CONTACT ROWS	DIMENSIONS						H	HARDWARE
		A	B		C	D	E		
			PLUG MAX	RCPT MAX			POTTING WELL MAX		
9	2	.775	.334	.400	.390	.565	.270	.298	#2-56 UNC THD (.092 DIA THRU)
15		.925	.484	.550	.540	.715			
21		1.075	.634	.700	.690	.865			
25		1.175	.734	.800	.790	.965			
31		1.325	.884	.950	.940	1.115			
37		1.475	1.034	1.100	1.090	1.265			
51	3	1.425	.984	1.050	1.040	1.215	.310	.341	
100	4	2.160	1.384	1.508	1.432	1.800	.360	.384	#4-40 UNC THD (.147 DIA THRU)



PLUG: MMHT-212-031-161-41WA  
 RECEPTACLE: MMHT-222-031-2G3-4500  
 XXXX-XXX-XXX-XXX-XXXX

PLUG		RECEPTACLE	
<b>SERIES</b>			
MMHT .050" Rugged Metal I/O Connector (MMHT mates with MMHT & MKHT receptacles)		MMHT .050" Rugged Metal I/O Connector (MMHT mates with MMHT & MKHT plugs)	
<b>BODY</b>			
2 2-Row (Sizes 9 thru 51****)	3 3-Row (Size 51 & 69***)	2 2-Row (Sizes 9 thru 51****)	3 3-Row (Size 51 & 69***)
4 4-Row (Size 100)		4 4-Row (Size 100)	
<b>BODY STYLE:</b>		<b>BODY STYLE:</b>	
1 Plug, straight, with ears		2 Receptacle, straight, with ears and interfacial seal High temperature.	
<b>BODY MATERIAL:</b>		<b>BODY MATERIAL:</b>	
2 High temperature thermoplastic with electroless nickel shell		2 High temperature thermoplastic with electroless nickel shell	
<b>SIZE</b>			
XXX 009, 015, 021, 025, 031, 037, 051, 100		XXX 009, 015, 021, 025, 031, 037, 051, 100	
<b>CONTACTS</b>			
<b>TYPE CONTACTS/TERMINATIONS:</b>		<b>TYPE CONTACTS/TERMINATIONS:</b>	
11 Pin, straight, 26 awg solder cup	1A Pin, straight, 24 awg solder cup	21 Socket, straight, 26 awg solder cup	2A Socket, straight, 24 awg solder cup
1D Pin, straight, .109" Lead Length (.018 dia) SEE NOTE 1	1E Pin, straight, .125" Lead Length (.018 dia) SEE NOTE 1	2D Socket, straight, .109" Lead Length (.018 dia)	2E Socket, straight, .125" Lead Length (.018 dia)
1F Pin, straight, .140" Lead Length (.018 dia) SEE NOTE 1	12 Pin, straight, .150" Lead Length (.018 dia) SEE NOTE 1	2F Socket, straight, .140" Lead Length (.018 dia)	22 Socket, straight, .150" Lead Length (.018 dia)
1G Pin, straight, .156" Lead Length (.018 dia) SEE NOTE 1	1H Pin, straight, .172" Lead Length (.018 dia) SEE NOTE 1	2G Socket, straight, .156" Lead Length (.018 dia)	2H Socket, straight, .172" Lead Length (.018 dia)
1J Pin, straight, .187" Lead Length (.018 dia) SEE NOTE 1	13 Pin, straight, .250" Lead Length (.018 dia) SEE NOTE 1	2J Socket, straight, .187" Lead Length (.018 dia)	23 Socket, straight, .250" Lead Length (.018 dia)
1K Pin, straight, .375" Lead Length (.018 dia) SEE NOTE 1	14 Pin, straight, .500" Lead Length (.018 dia) SEE NOTE 1	2K Socket, straight, .375" Lead Length (.018 dia)	2L Socket, straight, .500" Lead Length (.018 dia)
15 Pin, straight, 1.000" Lead Length (.018 dia) SEE NOTE 1	16 Pin, straight, crimped wire	2M Socket, straight, 1.000" Lead Length (.018 dia)	24 Socket, straight, .500" Lead Length (.018 dia) SEE NOTE 1
		25 Socket, straight, 1.000" Lead Length (.018 dia) SEE NOTE 1	26 Socket, straight, crimped wire
<b>PLATING OPTIONS:</b>		<b>PLATING OPTIONS:</b>	
1 50 μ" Au contacts (crimp wire)	3 50 μ" Au contacts (solder cup, pigtail)	1 50 μ" Au contacts (crimp wire)	3 50 μ" Au contacts (solder cup, pigtail)
<b>HARDWARE</b>			
<b>STYLE OF HARDWARE:</b>		<b>STYLE OF HARDWARE:</b>	
00 None	22 Two fixed jacknut assemblies (62°)	00 None	22 Two fixed jacknut assemblies (62°)
41 Two turning jackscrews, allen head, retaining ring (81°)	42 Two long turning jackscrews, allen head, retaining ring (82°)	41 Two turning jackscrews, allen head, retaining ring (81°)	42 Two long turning jackscrews, allen head, retaining ring (82°)
43 Two turning jackscrews, slot head, retaining ring (83°)	44 Two long turning jackscrews, slot head, retaining ring (84°)	43 Two turning jackscrews, slot head, retaining ring (83°)	44 Two long turning jackscrews, slot head, retaining ring (84°)
45 Two turning jackscrews, allen head, captivated** (85°)		45 Two turning jackscrews, allen head, captivated** (85°)	
<b>POLARIZATION / WIRING</b>		<b>POLARIZATION / WIRING</b>	
00 None	XX For wiring codes, see page MA-3 & MA-4	00 None	XX For wiring codes, see page MA-3 & MA-4

\* = Use numbers or letters in parenthesis when ordering size 100.  
 \*\* = Captive hardware is factory installed and non-removable.

NOTE 1 = The leads on these contacts are soft copper suitable for forming.



**Cable to Cable**  
**.050"**  
**9 thru 51 Contacts**  
**Low Profile Metal**  
**High Temperature**

**MQHT**

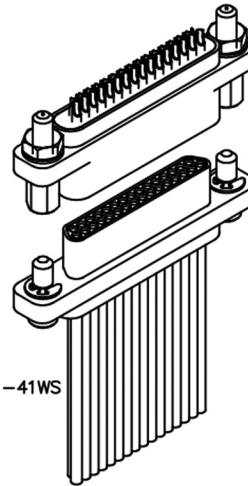

MQHT-222-031-2A3-2200  
(METAL)

MQHT-212-031-161-41WS  
(METAL)

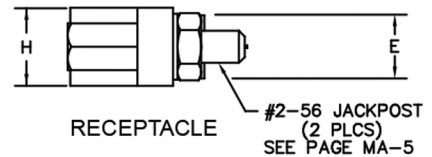
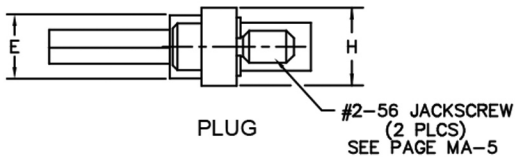
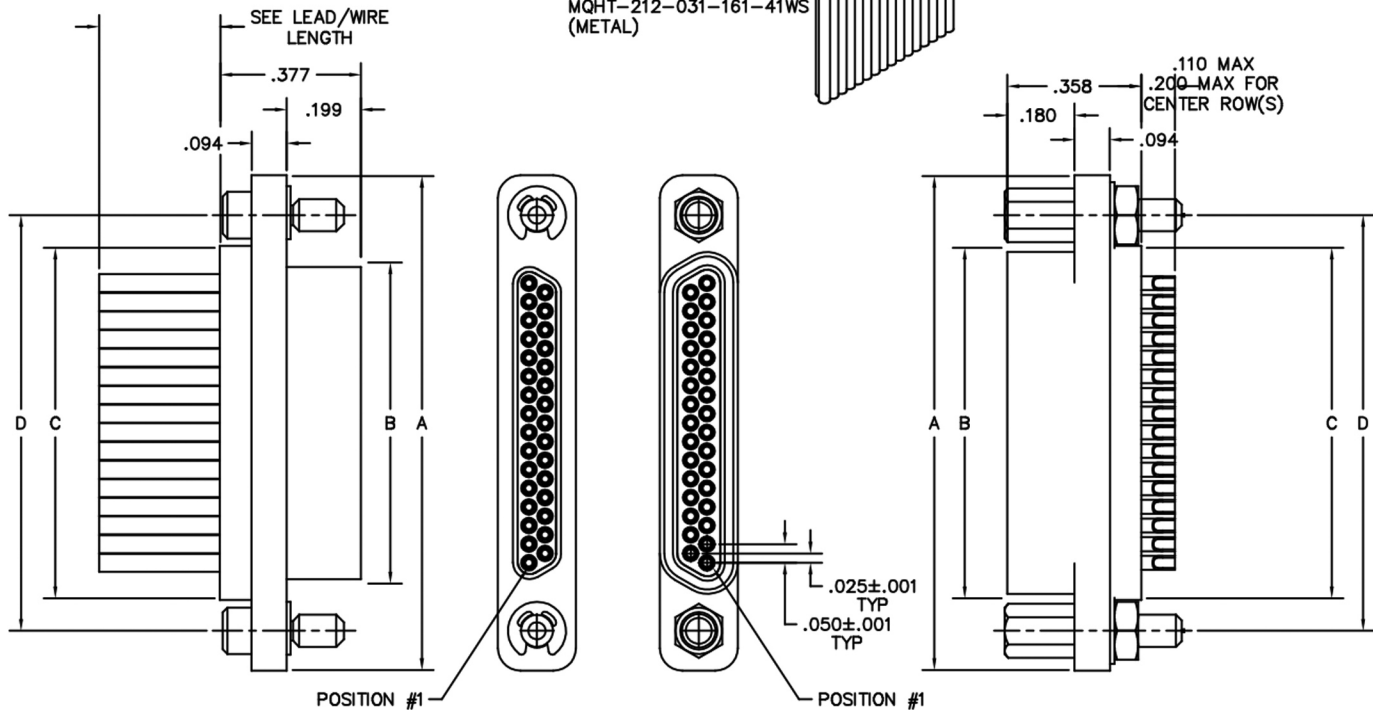

SIZE	CONTACT ROWS	DIMENSIONS							
		A	B		C	D	E	H	HARDWARE
			PLUG MAX	RCPT MAX					
9	2	.778	.292	.378	.398	.565	.173	.208	#2-56 UNC THD (.092 DIA THRU)
15		.928	.442	.528	.548	.715			
21		1.078	.592	.678	.698	.865			
25		1.178	.692	.778	.798	.965			
31		1.328	.842	.928	.948	1.115			
37		1.478	.992	1.078	1.098	1.265			
51	3	1.428	.942	1.028	1.048	1.215	.220	.250	



PLUG: MQHT-212-031-161-41WS  
 RECEPTACLE: MQHT-222-031-2G3-4500  
 XXXX-XXX-XXX-XXX-XXXX

PLUG		RECEPTACLE	
<b>SERIES</b>			
MQHT .050" Low Profile Metal I/O Connector (MQHT mates with MQHT & MSHT receptacles)		MQHT .050" Low Profile Metal I/O Connector (MQHT mates with MQHT & MSHT receptacles)	
<b>BODY</b>			
2 2-Row (Sizes 9 thru 37)		2 2-Row (Sizes 9 thru 37)	
3 3-Row (Size 51)		3 3-Row (Size 51)	
<b>BODY STYLE:</b>		<b>BODY STYLE:</b>	
1 Plug, straight, with ears. High Temperature.		2 Receptacle, straight, with ears. High temperature.	
<b>BODY MATERIAL:</b>		<b>BODY MATERIAL:</b>	
2 High temperature thermoplastic with electroless nickel shell		2 High temperature thermoplastic with electroless nickel shell	
<b>SIZE</b>			
XXX 009, 015, 021, 025, 031, 037, 051		XXX 009, 015, 021, 025, 031, 037, 051	
<b>CONTACTS</b>			
<b>TYPE CONTACTS/TERMINATIONS:</b>		<b>TYPE CONTACTS/TERMINATIONS:</b>	
11 Pin, straight, 26 awg solder cup		21 Socket, straight, 26 awg solder cup	
1A Pin, straight, 24 awg solder cup		2A Socket, straight, 24 awg solder cup	
1D Pin, straight, .109" Lead Length (.018 dia) SEE NOTE 1		2D Socket, straight, .109" Lead Length (.018 dia)	
1E Pin, straight, .125" Lead Length (.018 dia) SEE NOTE 1		2E Socket, straight, .125" Lead Length (.018 dia)	
1F Pin, straight, .140" Lead Length (.018 dia) SEE NOTE 1		2F Socket, straight, .140" Lead Length (.018 dia)	
1G Pin, straight, .150" Lead Length (.018 dia) SEE NOTE 1		22 Socket, straight, .150" Lead Length (.018 dia)	
1H Pin, straight, .156" Lead Length (.018 dia) SEE NOTE 1		2G Socket, straight, .156" Lead Length (.018 dia)	
1I Pin, straight, .172" Lead Length (.018 dia) SEE NOTE 1		2H Socket, straight, .172" Lead Length (.018 dia)	
1J Pin, straight, .187" Lead Length (.018 dia) SEE NOTE 1		2J Socket, straight, .187" Lead Length (.018 dia)	
1K Pin, straight, .250" Lead Length (.018 dia) SEE NOTE 1		23 Socket, straight, .250" Lead Length (.018 dia)	
1L Pin, straight, .375" Lead Length (.018 dia) SEE NOTE 1		2K Socket, straight, .375" Lead Length (.018 dia)	
1M Pin, straight, .500" Lead Length (.018 dia) SEE NOTE 1		2L Socket, straight, .500" Lead Length (.018 dia)	
1N Pin, straight, 1.000" Lead Length (.018 dia) SEE NOTE 1		2M Socket, straight, 1.000" Lead Length (.018 dia)	
16 Pin, straight, crimped wire		24 Socket, straight, .500" Lead Length (.018 dia) SEE NOTE 1	
		25 Socket, straight, 1.000" Lead Length (.018 dia) SEE NOTE 1	
		26 Socket, straight, crimped wire	
<b>PLATING OPTIONS:</b>		<b>PLATING OPTIONS:</b>	
1 50 μ" Au contacts (crimp wire)		1 50 μ" Au contacts (crimp wire)	
3 50 μ" Au contacts: 10 μ" Au terminations (solder cup, pigtail)		3 50 μ" Au contacts: 10 μ" Au terminations (solder cup, pigtail)	
<b>HARDWARE</b>			
<b>STYLE OF HARDWARE:</b>		<b>STYLE OF HARDWARE:</b>	
00 None		00 None	
22 Two fixed jacknut assemblies		22 Two fixed jacknut assemblies	
41 Two turning jackscrews, allen head, retaining ring		41 Two turning jackscrews, allen head, retaining ring	
42 Two long turning jackscrews, allen head, retaining ring		42 Two long turning jackscrews, allen head, retaining ring	
43 Two turning jackscrews, slot head, retaining ring		43 Two turning jackscrews, slot head, retaining ring	
44 Two long turning jackscrews, slot head, retaining ring		44 Two long turning jackscrews, slot head, retaining ring	
45 Two turning jackscrews, allen head, captivated*		45 Two turning jackscrews, allen head, captivated*	
<b>POLARIZATION / WIRING</b>		<b>POLARIZATION / WIRING</b>	
00 None		00 None	
XX For wiring codes, see page MA-3 & MA-4		XX For wiring codes, see page MA-3 & MA-4	

XX

\* = Captive hardware is factory installed and non-removable.

NOTE 1 = The leads on these contacts are soft copper suitable for forming.



**Board (Narrow Footprint) to Cable**  
**.050"**

9 thru 100 Contacts

**Rugged Board Mount**  
**High Temperature**

**MKHT**

**Rugged Cable**  
**High Temperature**

**MMHT**

MKHT-262-031-443-220S  
(METAL)

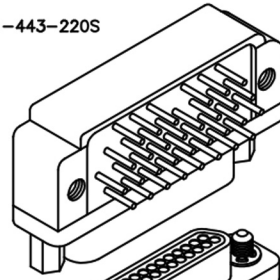

MMHT-212-031-113-4300  
(METAL)

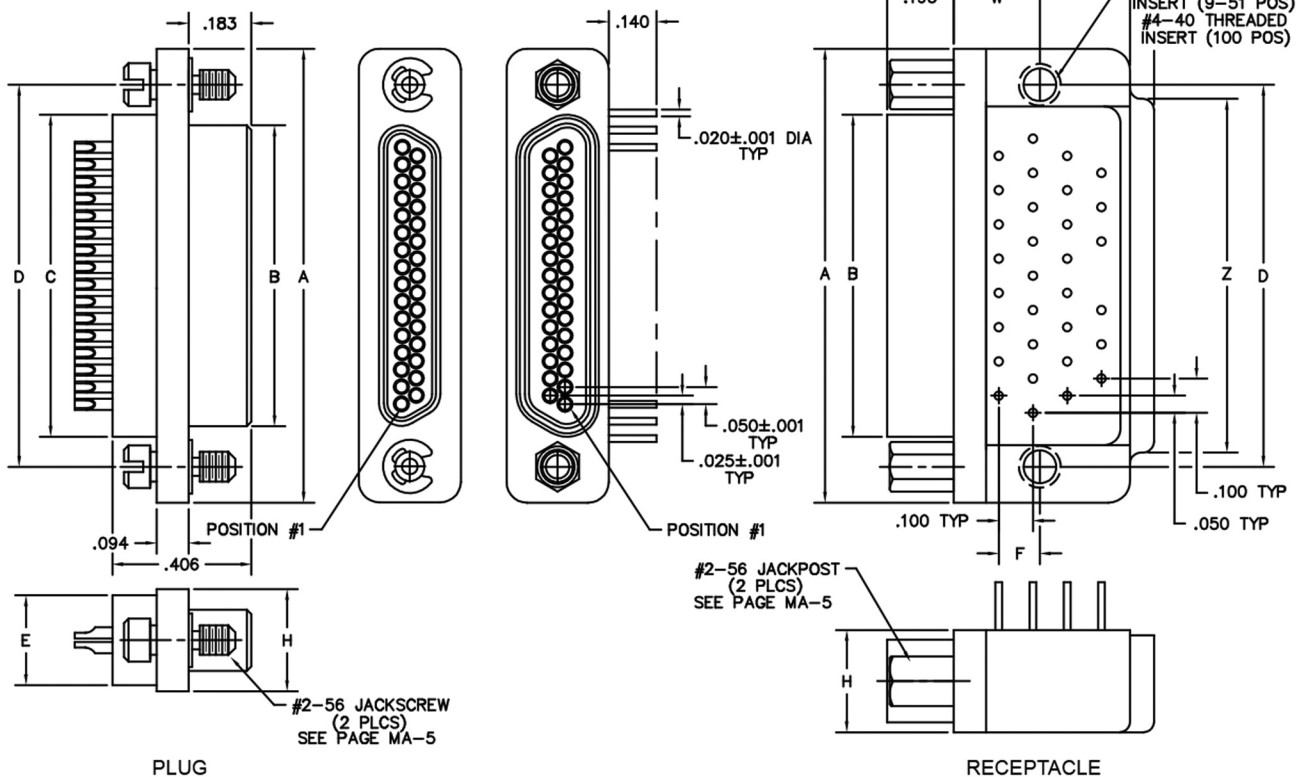
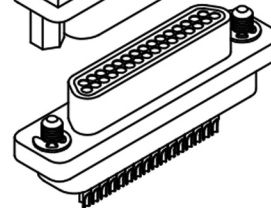

SIZE	CONTACT ROWS	DIMENSIONS											HARDWARE			
		A	B		C	D	E		F	H	W	X MAX		Y MAX	Z	
			PLUG MAX	RCPT MAX			POTTING WELL MAX									
9	2	.775	.334	.400	.390	.565	.270	.120	.298	.250		.420	.420	1.175	#2-56 UNC THD	
15		.925	.484	.550	.540	.715										.775
21		1.075	.634	.700	.690	.865										1.075
25		1.175	.734	.800	.790	.965										1.175
31		1.325	.884	.950	.940	1.115										1.175
37	1.475	1.034	1.100	1.090	1.265	1.180										
51	3	1.425	.984	1.050	1.040	1.215	.310	.150	.341	.300	.430	.650	1.220	#4-40 UNC THD		
100	4	2.160	1.384	1.508	1.432	1.800	.360	.200	.384	.400	.590	1.000	1.810			



PLUG: MMHT- 212 - 031 - 113 - 4300  
 RECEPTACLE: MKHT- 262 - 031 - 443 - 220S  
 XXXX - XXX - XXX - XXX - XXXX

PLUG	RECEPTACLE
<b>SERIES</b>	
MMHT .050" Rugged Metal I/O Connector (MMHT mates with MMHT & MKHT receptacles)	MKHT .050" Rugged Metal PC Board Mount Connector (MKHT mates with MMHT plugs)
<b>BODY</b>	
2 2-Row (Sizes 9 thru 37) 3 3-Row (Size 51) 4 4-Row (Size 100)	2 2-Row (Sizes 9 thru 37) 3 3-Row (Size 51) 4 4-Row (Size 100)
<b>BODY STYLE:</b> 1 Plug, straight, with ears. High temperature.	<b>BODY STYLE:</b> 6 Receptacle, right angle, narrow footprint, w/ threaded inserts and interfacial seal. High temperature.
<b>BODY MATERIAL:</b> 2 High temperature thermoplastic with electroless nickel shell	<b>BODY MATERIAL:</b> 2 High temperature thermoplastic with electroless nickel shell
<b>SIZE</b>	
XXX 009, 015, 021, 025, 031, 037, 051, 100	XXX 009, 015, 021, 025, 031, 037, 051, 100
<b>CONTACTS</b>	
<b>TYPE CONTACTS/TERMINATIONS:</b> 11 Pin, straight, solder cup 14 Pin, straight, .500" pigtails (.018 dia) 15 Pin, straight, 1.000" pigtails (.018 dia) 16 Pin, straight, crimped wire	<b>TYPE CONTACTS/TERMINATIONS:</b> 43 Socket, right angle, dip solder, .109" x .020" dia 44 Socket, right angle, dip solder, .140" x .020" dia 45 Socket, right angle, dip solder, .172" x .020" dia
<b>PLATING OPTIONS:</b> 1 50 μ" Au contacts (crimp wire) 3 50 μ" Au contacts: 10 μ" Au terminations (solder cup, pigtail)	<b>PLATING OPTIONS:</b> 3 50 μ" Au contacts: 10 μ" Au terminations
<b>HARDWARE</b>	
<b>STYLE OF HARDWARE:</b> 00 None 41 Two turning jackscrews, allen head, retaining ring (81*) 42 Two long turning jackscrews, allen head, retaining ring (82*) 43 Two turning jackscrews, slot head, retaining ring (83*) 44 Two long turning jackscrews, slot head, retaining ring (84*) 45 Two turning jackscrews, allen head, captivated** (85*)	<b>STYLE OF HARDWARE:</b> 00 None 22 Two fixed jacknut assemblies (62*)
<b>POLARIZATION / WIRING:</b> 00 None XX For wiring codes, see page MA-3 & MA-4	<b>POLARIZATION / WIRING</b> 0S Standard body polarization

\* = Use number in parenthesis when ordering size 100.  
 \*\* = Captive hardware is factory installed and non-removable.



MKHT-252-031-335-220S  
(METAL)

# Board (Narrow Footprint) to Cable .050"

9 thru 100 Contacts

**Rugged Board Mount**      **Rugged Cable**  
**High Temperature**      **High Temperature**

**MKHT**

**MMHT**

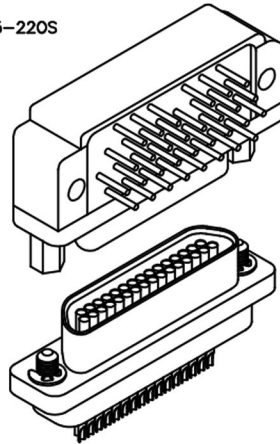

MMHT-222-031-213-4100  
(METAL)

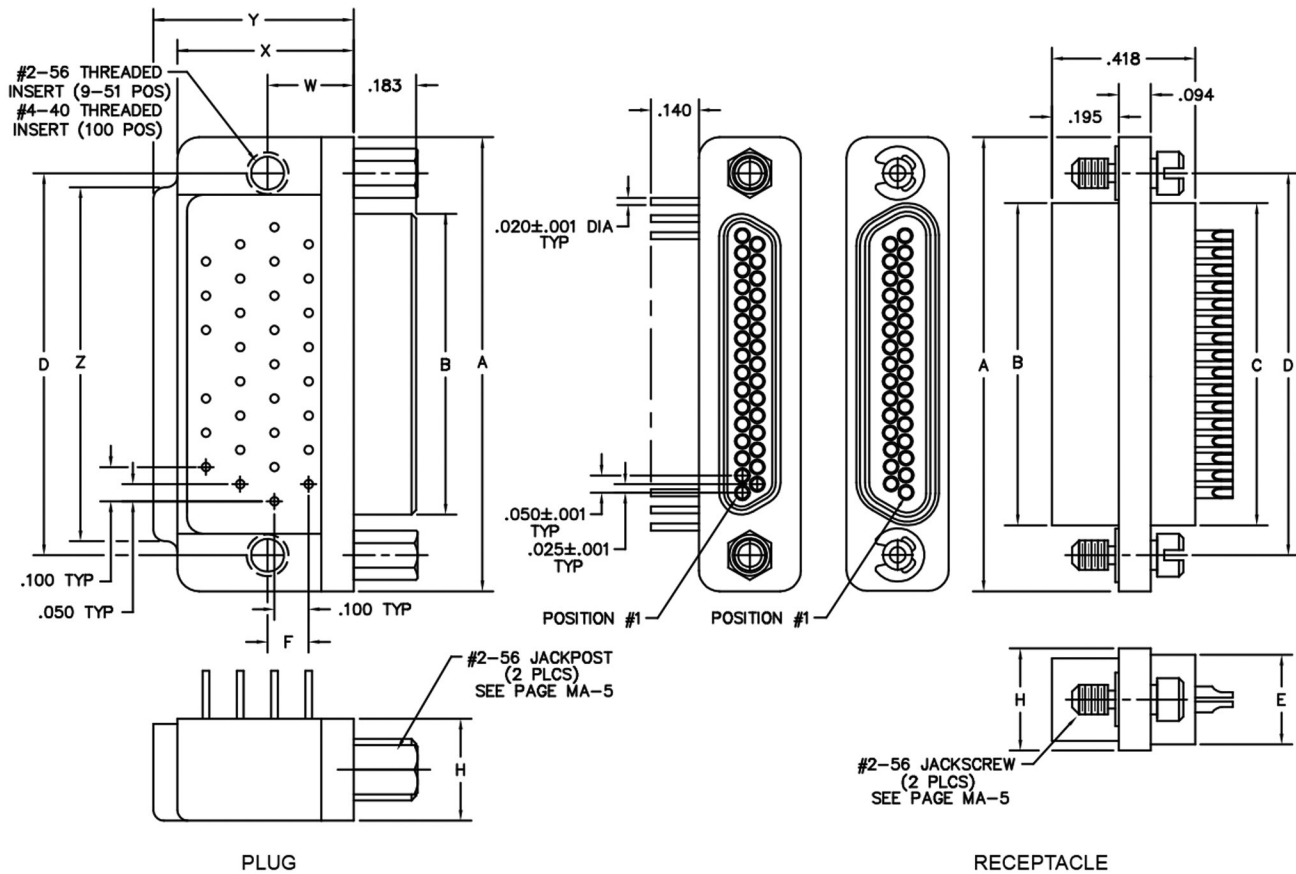

DIMENSIONS														
SIZE	CONTACT ROWS	A	B		C	D	E	F	H	W	X MAX	Y MAX	Z	HARDWARE
			PLUG MAX	RCPT MAX										
9	2	.775	.334	.400	.390	.565	.270	.020	.298	.250	.420	.420	.775	#2-56 UNC THD
15		.925	.484	.550	.540	.715							.925	
21		1.075	.634	.700	.690	.865							1.075	
25		1.175	.734	.800	.790	.965							1.175	
31		1.325	.884	.950	.940	1.115							1.325	
37		1.475	1.034	1.100	1.090	1.265							1.475	
51	3	1.425	.984	1.050	1.040	1.215	.310	.150	.341	.300	.430	.650	1.220	#4-40 UNC THD
100	4	2.160	1.384	1.508	1.432	1.800	.360	.200	.384	.400	.590	1.000	1.810	



**PLUG:** MKHT-252-031-335-220S  
**RECEPTACLE:** MMHT-222-031-213-4100  
 XXXX-XXX-XXX-XXX-XXXX-XXX

PLUG		RECEPTACLE	
<b>SERIES</b>			
MKHT .050" Rugged Metal PC Board Mount Connector (MKHT mates with MMHT receptacles)		MMHT .050" Rugged Metal I/O Connector (MMHT mates with MKHT & MMHT plugs)	
<b>BODY</b>			
2 2-Row (Sizes 9 thru 37)	2 2-Row (Sizes 9 thru 37)	3 3-Row (Size 51)	3 3-Row (Size 51)
3 3-Row (Size 51)	4 4-Row (Size 100)	4 4-Row (Size 100)	
<b>BODY STYLE:</b> 5 Plug, right angle, narrow footprint, w/ threaded inserts. High temperature.		<b>BODY STYLE:</b> 2 Receptacle, straight, with ears. High temperature.	
<b>BODY MATERIAL:</b> 2 High temperature thermoplastic with electroless nickel shell		<b>BODY MATERIAL:</b> 2 High temperature thermoplastic with electroless nickel shell	
<b>SIZE</b>			
XXX 009, 015, 021, 025, 031, 037, 051, 100		XXX 009, 015, 021, 025, 031, 037, 051, 100	
<b>CONTACTS</b>			
<b>TYPE CONTACTS/TERMINATIONS:</b> 32 Pin, right angle, dip solder, .109" 33 Pin, right angle, dip solder, .140" 34 Pin, right angle, dip solder, .172"		<b>TYPE CONTACTS/TERMINATIONS:</b> 21 Socket, straight, solder cup 24 Socket, straight, .500" pigtails (.018 dia) 25 Socket, straight, 1.000" pigtails (.018 dia) 26 Socket, straight, crimped wire	
<b>PLATING OPTIONS:</b> 3 50 μ" Au contacts: 10 μ" Au terminations		<b>PLATING OPTIONS:</b> 1 50 μ" Au contacts (crimp wire) 3 50 μ" Au contacts: 10 μ" Au terminations (solder cup, pigtail)	
<b>HARDWARE</b>			
<b>STYLE OF HARDWARE:</b> 00 None 22 Two fixed jacknut assemblies (62*)		<b>STYLE OF HARDWARE:</b> 00 None 41 Two turning jackscrews, allen head, retaining ring (81*) 42 Two long turning jackscrews, allen head, retaining ring (82*) 43 Two turning jackscrews, slot head, retaining ring (83*) 44 Two long turning jackscrews, slot head, retaining ring (84*) 45 Two turning jackscrews, allen head, captivated** (85*)	
<b>POLARIZATION / WIRING:</b> 0S Standard body polarization		<b>POLARIZATION / WIRING:</b> 00 None XX For wiring codes, see page MA-3 & MA-4	
<b>OPTIONS</b>			
		900 Interfacial sealing gasket	

\* = Use number in parenthesis when ordering size 100.  
 \*\* = Captive hardware is factory installed and non-removable.



**Recommended PC  
Board Layout**  
Right Angle, Narrow Footprint  
Standard Polarization

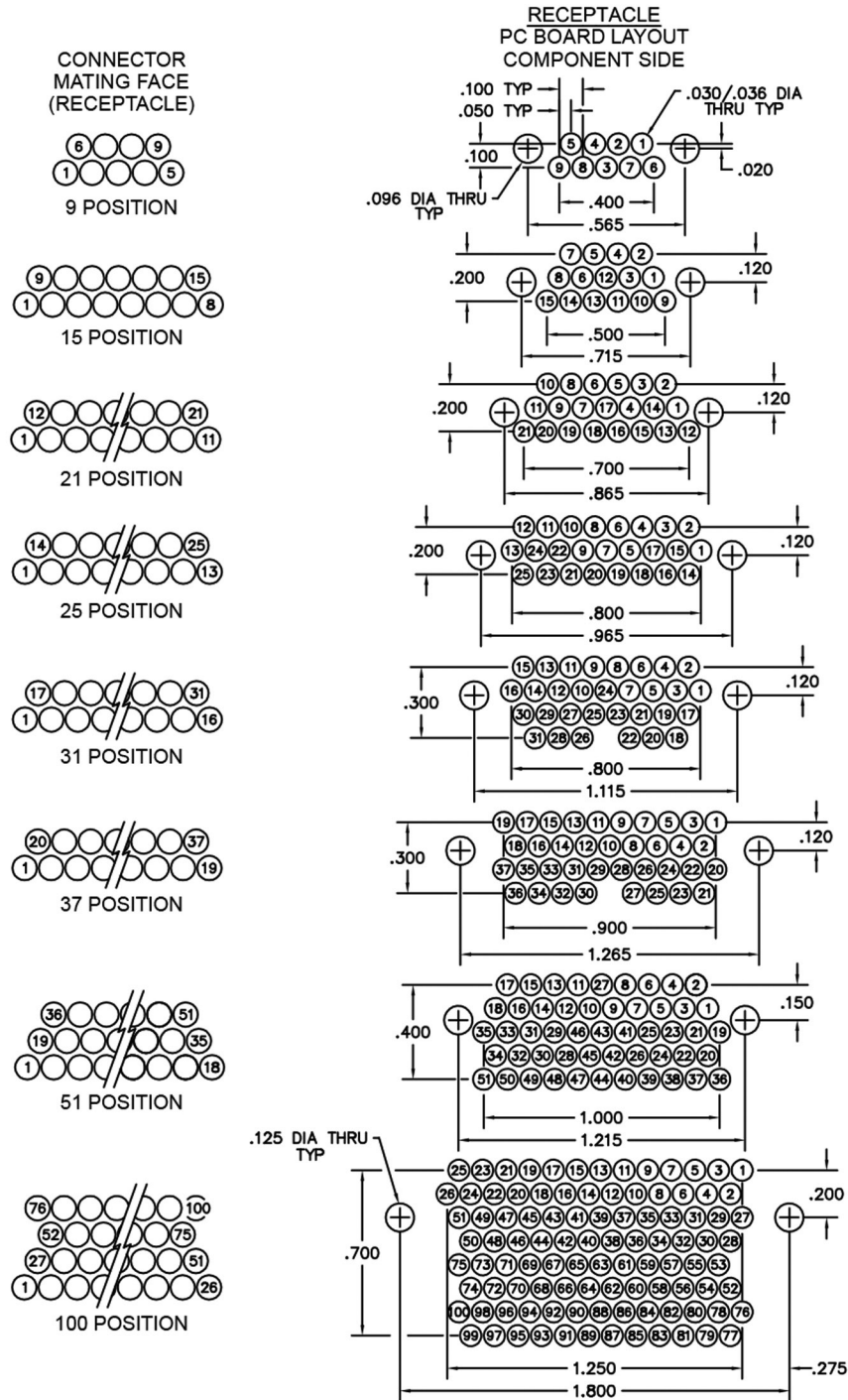
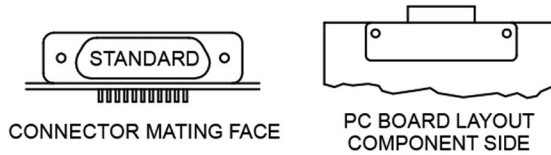

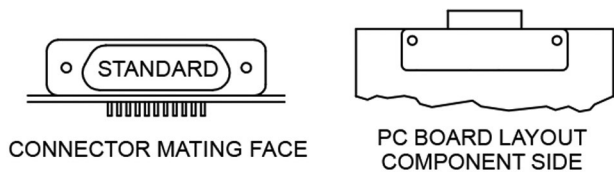

## Recommended PC Board Layout

Right Angle, Narrow Footprint  
Standard Polarization

CONNECTOR MATING FACE (PLUG)

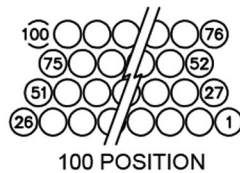

PLUG PC BOARD LAYOUT COMPONENT SIDE

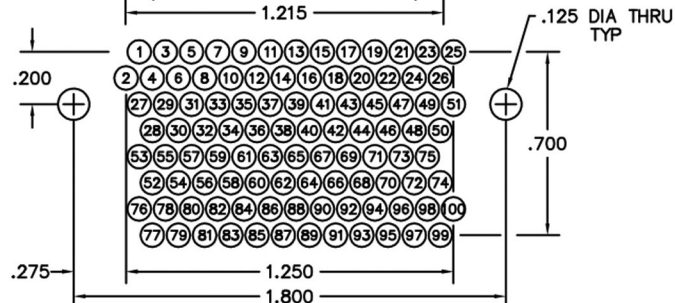
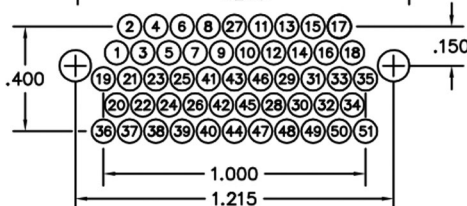
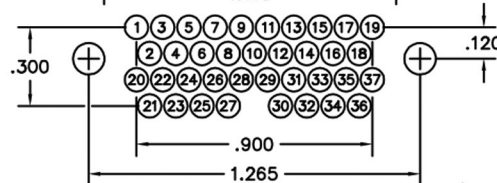
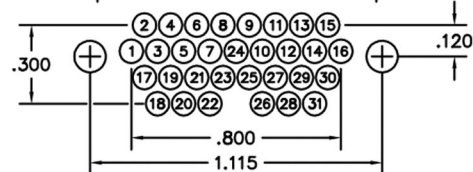
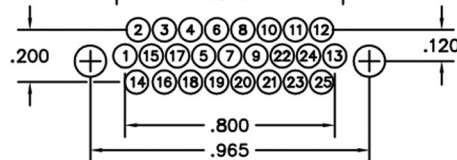
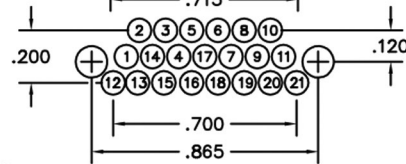
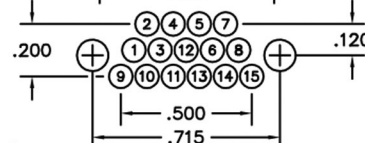
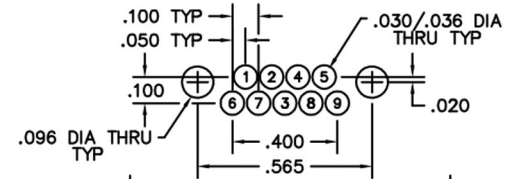



**Board (Narrow Footprint) to Cable**  
**.050"**

9 thru 51 Contacts

**Low Profile Board Mount**  
**High Temperature**

**MSHT**

**Low Profile Cable**  
**High Temperature**

**MQHT**

MSHT-262-037-435-220S  
(METAL)

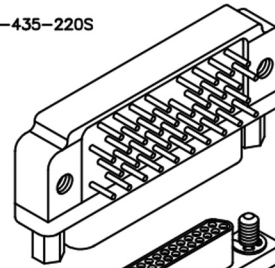

MQHT-212-037-161-41WS  
(METAL)

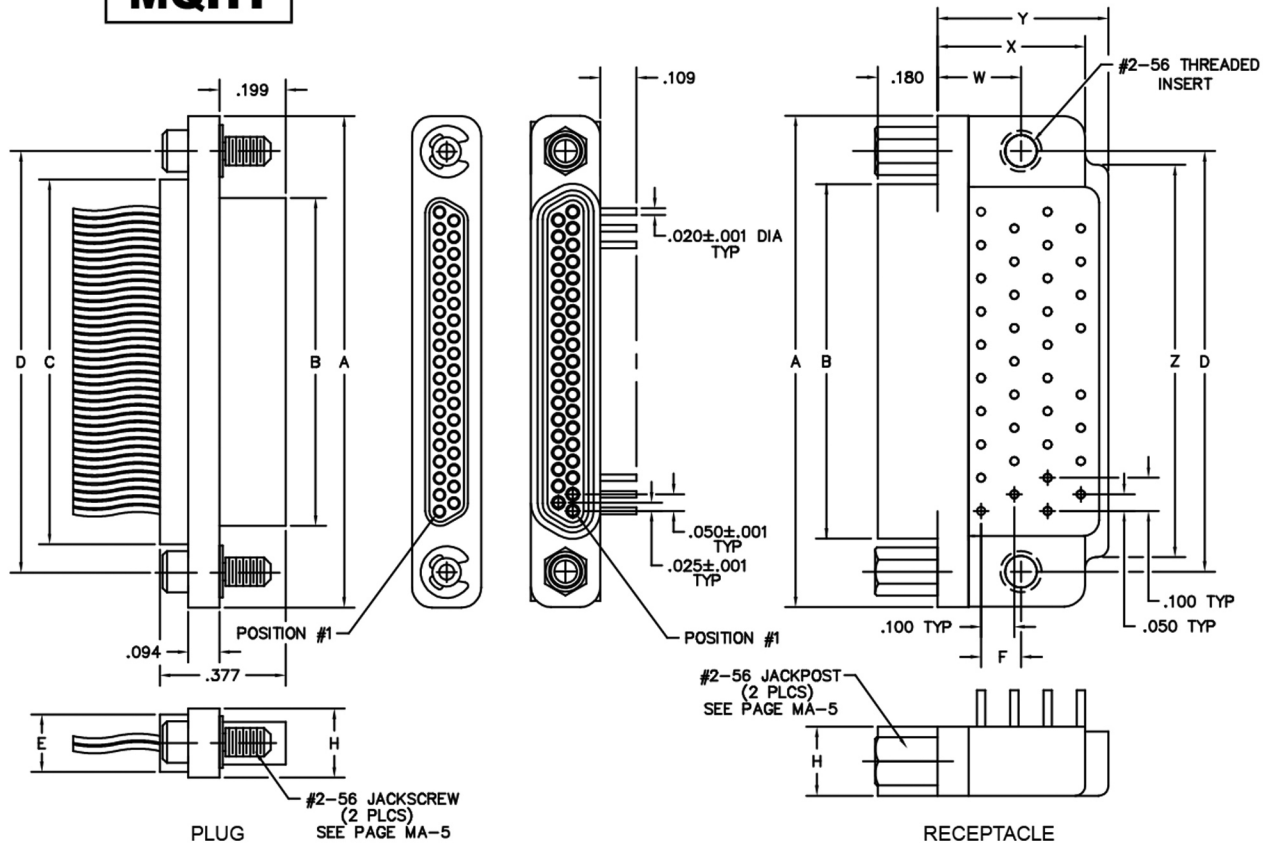
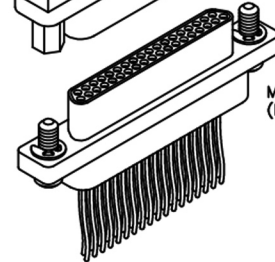

SIZE	CONTACT ROWS	DIMENSIONS											HARDWARE	
		A	B		C	D	E		F	H	W	X MAX		Y MAX
		PLUG MAX	RCPT MAX			POTTING WELL MAX								
9	2	.778	.292	.378	.398	.565	.173	.020		.208	.250			.775
15		.928	.442	.528	.548	.715								.925
21		1.078	.592	.678	.698	.865								1.075
25		1.178	.692	.778	.798	.965								1.175
31		1.328	.842	.928	.948	1.115								1.080
37	1.478	.992	1.078	1.098	1.265	1.180								
51	3	1.428	.942	1.028	1.048	1.215	.220	.150	.250	.300	.425	.650	1.220	#2-56 UNC THD



**PLUG:** MQHT-212-037-161-41WS  
**RECEPTACLE:** MSHT-262-037-433-220S  
 XXXX-XXX-XXX-XXX-XXXX

**PLUG**

**RECEPTACLE**

SERIES	
MQHT .050" Low Profile Metal I/O Connector (MQHT mates with MQHT & MSHT receptacles)	MSHT .050" Low Profile Metal PC Board Mount Connector (MSHT mates with MQHT plugs)
BODY	
2 2-Row (Sizes 9 thru 37) 3 3-Row (Size 51)	2 2-Row (Sizes 9 thru 37) 3 3-Row (Size 51)
<b>BODY STYLE:</b> 1 Plug, straight, with ears. High temperature.	<b>BODY STYLE:</b> 6 Receptacle, right angle, narrow footprint, w/ threaded inserts. High temperature.
<b>BODY MATERIAL:</b> 2 High temperature thermoplastic with electroless nickel shell	<b>BODY MATERIAL:</b> 2 High temperature thermoplastic with electroless nickel shell
SIZE	
XXX 009, 015, 021, 025, 031, 037, 051	XXX 009, 015, 021, 025, 031, 037, 051
CONTACTS	
<b>TYPE CONTACTS/TERMINATIONS:</b> 11 Pin, straight, solder cup 14 Pin, straight, .500" pigtails (.018 dia) 15 Pin, straight, 1.000" pigtails (.018 dia) 16 Pin, straight, crimped wire	<b>TYPE CONTACTS/TERMINATIONS:</b> 43 Socket, right angle, dip solder, .109" x .020" dia 44 Socket, right angle, dip solder, .140" x .020" dia 45 Socket, right angle, dip solder, .172" x .020" dia
<b>PLATING OPTIONS:</b> 1 50 μ" Au contacts (crimp wire) 3 50 μ" Au contacts: 10 μ" Au terminations (solder cup, pigtail)	<b>PLATING OPTIONS:</b> 3 50 μ" Au contacts: 10 μ" Au terminations
HARDWARE	
<b>STYLE OF HARDWARE:</b> 00 None 41 Two turning jackscrews, allen head, retaining ring 42 Two long turning jackscrews, allen head, retaining ring 43 Two turning jackscrews, slot head, retaining ring 44 Two long turning jackscrews, slot head, retaining ring 45 Two turning jackscrews, allen head, captivated*	<b>STYLE OF HARDWARE:</b> 00 None 22 Two fixed jacknut assemblies
<b>POLARIZATION / WIRING:</b> 00 None XX For wiring codes, see page MA-3 & MA-4	<b>POLARIZATION / WIRING:</b> 0S Standard body polarization

\* = Captive hardware is factory installed and non-removable.



**Low Profile Cable  
Board (Narrow  
Footprint) to Cable  
.050"  
9 thru 51 Contacts  
Low Profile Board Mount  
High Temperature**

**MQHT**

**MSHT**

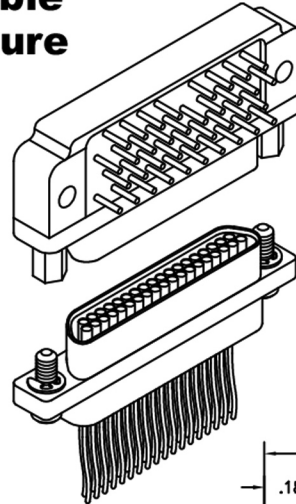

MSHT-252-037-325-220S  
(METAL)

MQHT-222-037-261-41WS  
(METAL)

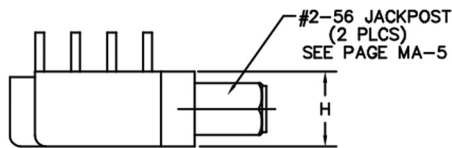
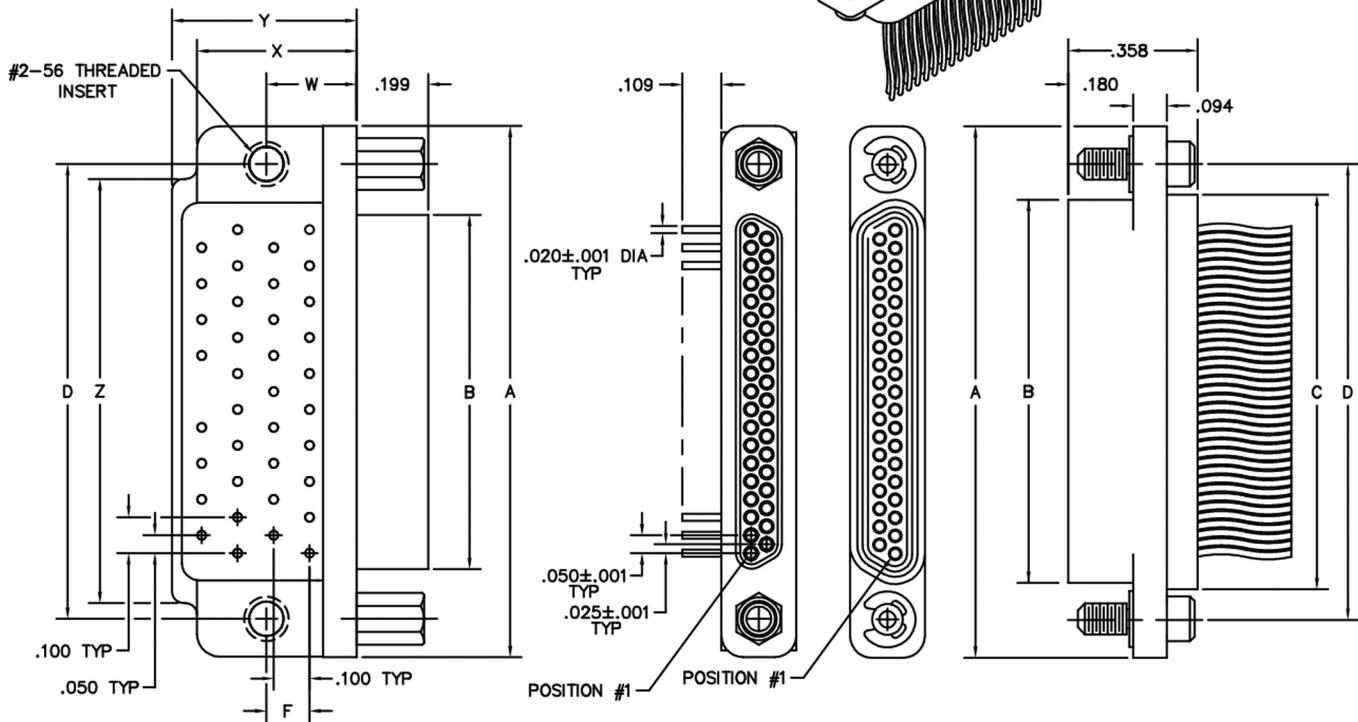

PLUG

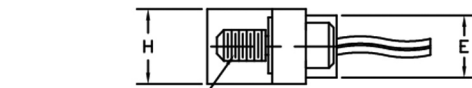

RECEPTACLE

SIZE	CONTACT ROWS	DIMENSIONS											HARDWARE		
		A	B		C	D	E	F	H	W	X MAX	Y MAX		Z	
			PLUG MAX	RCPT MAX			POTTING WELL MAX								
9	2	.778	.292	.378	.398	.565	.173	.120	.208	.250	.420	.420	.775	#2-56 UNC THD	
15		.928	.442	.528	.548	.715							.925		
21		1.078	.592	.678	.698	.865							1.075		
25		1.178	.692	.778	.798	.965							1.175		
31		1.328	.842	.928	.948	1.115							1.080		
37		1.478	.992	1.078	1.098	1.265							1.180		
51	3	1.428	.942	1.028	1.048	1.215	.220	.150	.250	.300	.425	.650	1.220		



**PLUG:** MSHT-252-037-323-220S  
**RECEPTACLE:** MQHT-222-037-261-41WS  
 XXXX-XXX-XXX-XXX-XXXX

**PLUG**

**RECEPTACLE**

<b>SERIES</b>	
MSHT .050" Low Profile Metal PC Board Mount Connector (MSHT mates with MQHT receptacles)	MQHT .050" Low Profile Metal I/O Connector (MQHT mates with MQHT & MSHT plugs)
<b>BODY</b>	
2 2-Row (Sizes 9 thru 37) 3 3-Row (Size 51)	2 2-Row (Sizes 9 thru 37) 3 3-Row (Size 51)
<b>BODY STYLE:</b> 5 Plug, right angle, narrow footprint, w/ threaded inserts. High temperature.	<b>BODY STYLE:</b> 2 Receptacle, straight, with ears. High temperature.
<b>BODY MATERIAL:</b> 2 High temperature thermoplastic with electroless nickel shell	<b>BODY MATERIAL:</b> 2 High temperature thermoplastic with electroless nickel shell
<b>SIZE</b>	
XXX 009, 015, 021, 025, 031, 037, 051	XXX 009, 015, 021, 025, 031, 037, 051
<b>CONTACTS</b>	
<b>TYPE CONTACTS/TERMINATIONS:</b> 32 Pin, right angle, dip solder, .109" 33 Pin, right angle, dip solder, .140" 34 Pin, right angle, dip solder, .172"	<b>TYPE CONTACTS/TERMINATIONS:</b> 21 Socket, straight, solder cup 24 Socket, straight, .500" pigtails (.018 dia) 25 Socket, straight, 1.000" pigtails (.018 dia) 26 Socket, straight, crimped wire
<b>PLATING OPTIONS:</b> 3 50 μ" Au contacts: 10 μ" Au terminations	<b>PLATING OPTIONS:</b> 1 50 μ" Au contacts (crimp wire) 3 50 μ" Au contacts: 10 μ" Au terminations (solder cup, pigtail)
<b>HARDWARE</b>	
<b>STYLE OF HARDWARE:</b> 00 None 22 Two fixed jacknut assemblies	<b>STYLE OF HARDWARE:</b> 00 None 41 Two turning jackscrews, allen head, retaining ring 42 Two long turning jackscrews, allen head, retaining ring 43 Two turning jackscrews, slot head, retaining ring 44 Two long turning jackscrews, slot head, retaining ring 45 Two turning jackscrews, allen head, captivated*
<b>POLARIZATION / WIRING:</b> 0S Standard body polarization	<b>POLARIZATION / WIRING</b> 00 None XX For wiring codes, see page MA-3 & MA-4

\* = Captive hardware is factory installed and non-removable.



# Recommended PC Board Layout

Right Angle, Narrow Footprint  
Standard Polarization



CONNECTOR MATING FACE

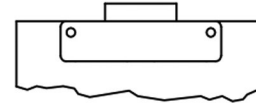

PC BOARD LAYOUT COMPONENT SIDE

CONNECTOR MATING FACE (RECEPTACLE)



9 POSITION



15 POSITION



21 POSITION



25 POSITION



31 POSITION



37 POSITION



51 POSITION

RECEPTACLE  
PC BOARD LAYOUT  
COMPONENT SIDE

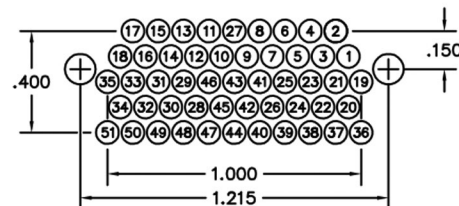
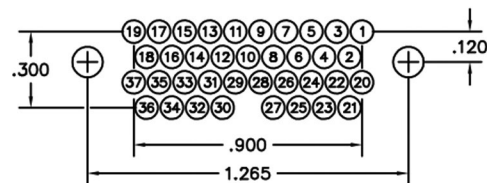
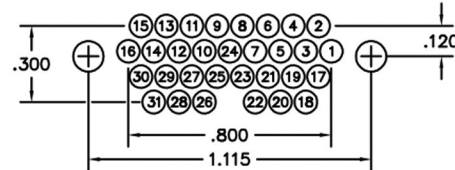
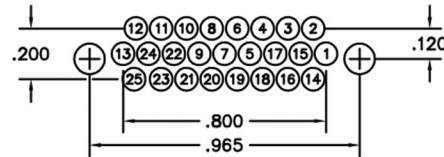
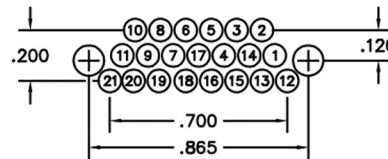
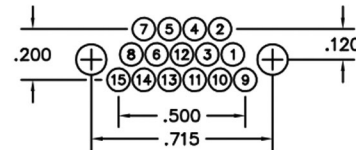
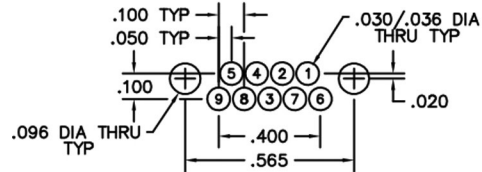

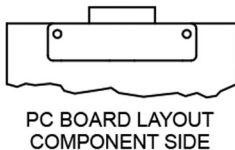
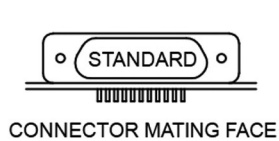

## Recommended PC Board Layout

Right Angle, Narrow Footprint  
Standard Polarization

CONNECTOR  
MATING FACE  
(PLUG)



PLUG  
PC BOARD LAYOUT  
COMPONENT SIDE

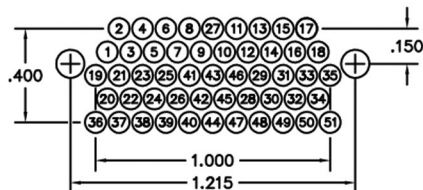
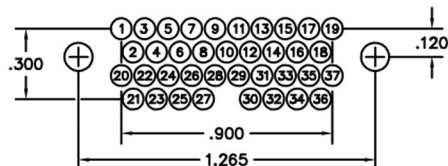
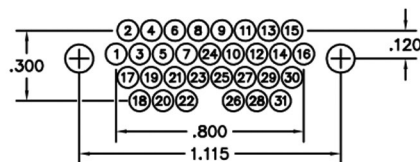
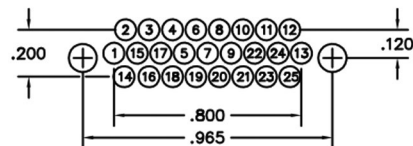
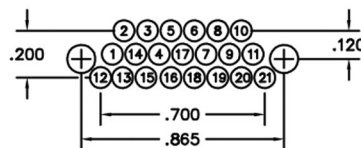
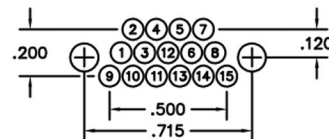
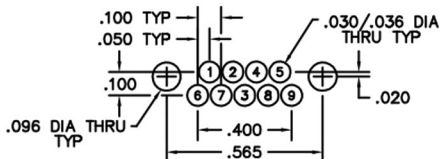



# Cable to Board

**.050"**

9 thru 51 Contacts

**Low Profile Cable  
High Temperature**

**MTHT**

**Low Profile Board Mount  
High Temperature**

**MTHT**

MHT-212-021-161-43WQ  
(METAL)

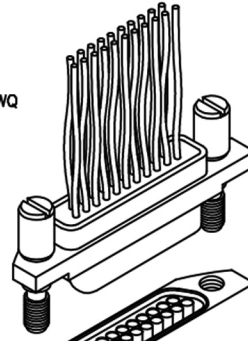

MHT-2E2-021-433-000S  
(METAL)

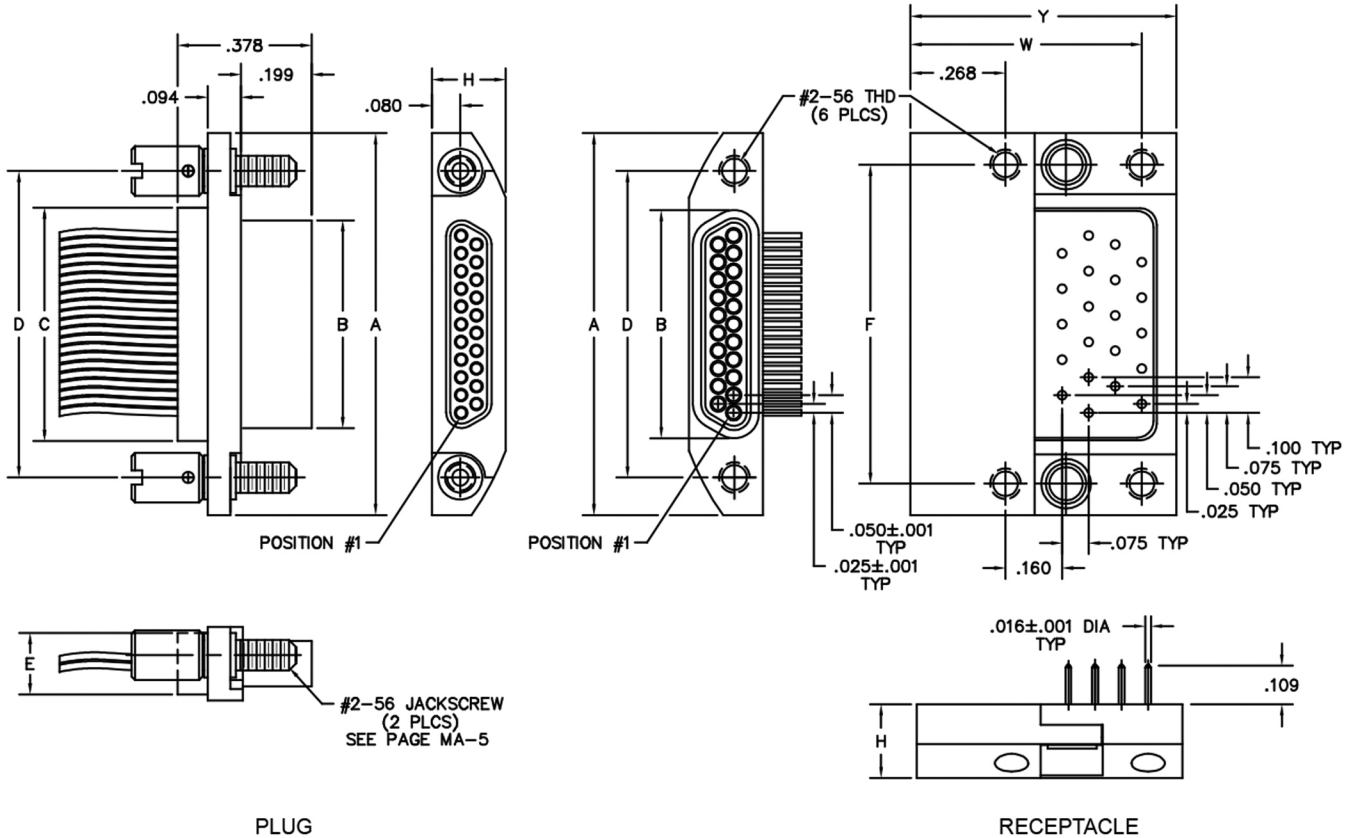
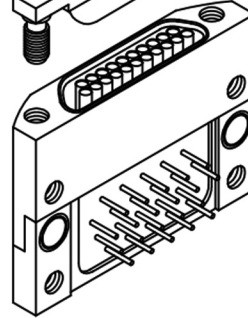

SIZE	CONTACT ROWS	DIMENSIONS										
		A	B		C	D	E POTTING WELL MAX	F	H	HARDWARE	W	Y
			PLUG MAX	RCPT MAX								
9	2	.778	.292	.378	.398	.565	.173	.600	.208	#2-56 UNC THD (.092 DIA THRU)	.608	.690
15		.928	.442	.528	.548	.715		.750				
21		1.078	.592	.678	.698	.865		.900				
25		1.178	.692	.778	.798	.965		1.000				
31		1.328	.842	.928	.948	1.115		1.150				
37		1.478	.992	1.078	1.098	1.265		1.300				
51	3	1.428	.942	1.028	1.048	1.215	.220	1.250	.250		.728	.825



**PLUG:** MTHT-212-021-161-43WQ  
**RECEPTACLE:** MTHT-2E2-021-433-000S  
 XXXX-XXX-XXX-XXX-XXXX

PLUG		RECEPTACLE	
<b>SERIES</b>			
MTHT .050" Low Profile Metal I/O Connector (MTHT mates with MTHT receptacles)		MTHT .050" Low Profile Metal PC Board Mount Connector (MTHT mates with MTHT plugs)	
<b>BODY</b>			
2 2-Row (Sizes 9 thru 37)	3 3-Row (Size 51)	2 2-Row (Sizes 9 thru 37)	3 3-Row (Size 51)
<b>BODY STYLE:</b> 1 Plug, straight, with ears. Low profile, radius. High temperature.		<b>BODY STYLE:</b> E Receptacle, right angle, with four mounting holes. Low profile, radius. High temperature.	
<b>BODY MATERIAL:</b> 2 High temperature thermoplastic with electroless nickel shell		<b>BODY MATERIAL:</b> 2 High temperature thermoplastic with electroless nickel shell	
<b>SIZE</b>			
XXX 009, 015, 021, 025, 031, 037, 051		XXX 009, 015, 021, 025, 031, 037, 051	
<b>CONTACTS</b>			
<b>TYPE CONTACTS/TERMINATIONS:</b> 11 Pin, straight, solder cup 14 Pin, straight, .500" pigtails (.018 dia) 15 Pin, straight, 1.000" pigtails (.018 dia) 16 Pin, straight, crimped wire		<b>TYPE CONTACTS/TERMINATIONS:</b> 43 Socket, right angle, gold plated, .109" x .016" dia 44 Socket, right angle, gold plated, .140" x .016" dia 45 Socket, right angle, gold plated, .172" x .016" dia	
<b>PLATING OPTIONS:</b> 1 50 μ" Au contacts (crimp wire) 3 50 μ" Au contacts: 10 μ" Au terminations (solder cup, pigtail)		<b>PLATING OPTIONS:</b> 3 50 μ" Au contacts: 10 μ" Au terminations	
<b>HARDWARE</b>			
<b>STYLE OF HARDWARE:</b> 00 None 41 Two turning jackscrews, allen head 43 Two turning jackscrews, slot head		<b>STYLE OF HARDWARE:</b> 00 Integrated jacknuts	
<b>POLARIZATION / WIRING:</b> 00 None XX For wiring codes, see page MA-3 & MA-4		<b>POLARIZATION / WIRING:</b> 0S Standard body polarization	



CONNECTOR MATING FACE



PC BOARD LAYOUT COMPONENT SIDE

## Recommended PC Board Layout

Low Profile, Right Angle  
Standard Polarization

CONNECTOR MATING FACE (RECEPTACLE)

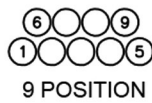

RECEPTACLE  
PC BOARD LAYOUT  
COMPONENT SIDE

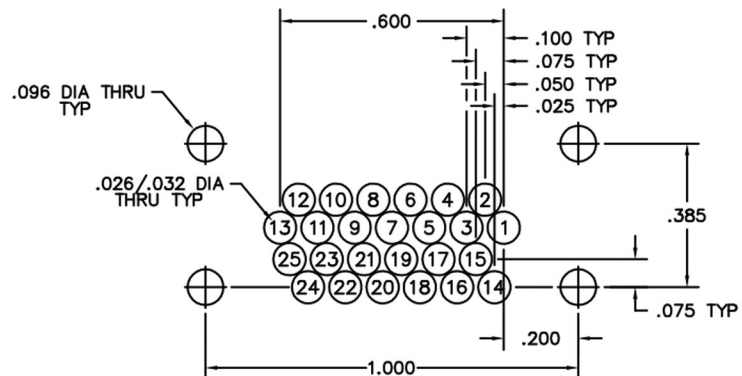
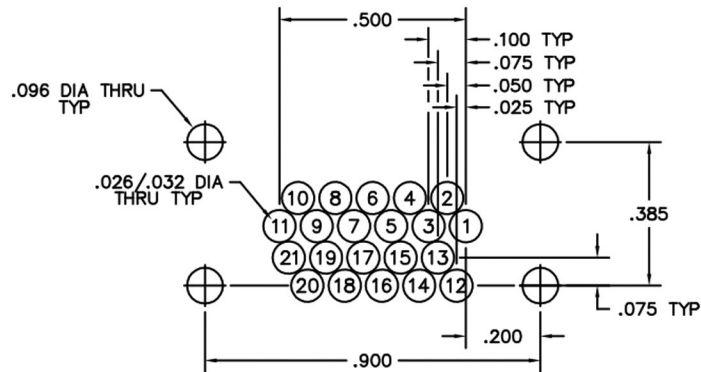
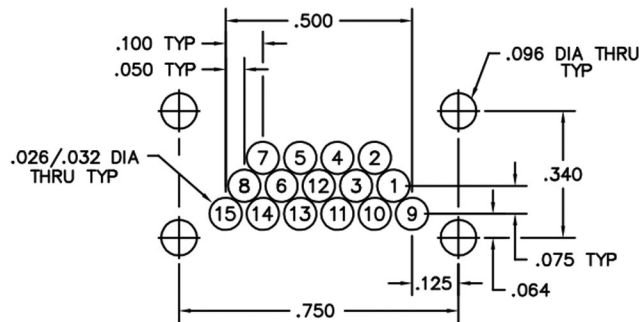
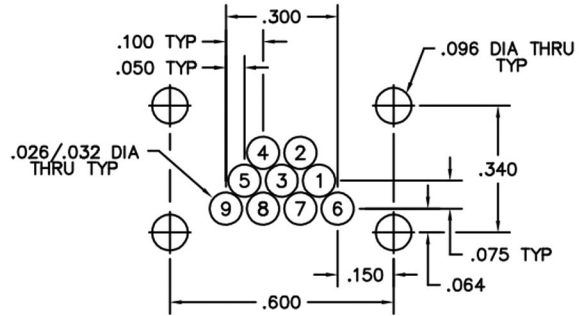

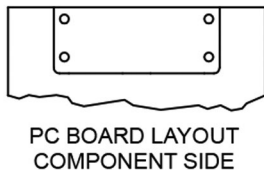
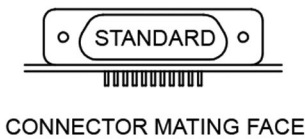

## Recommended PC Board Layout

Low Profile, Right Angle  
Standard Polarization

CONNECTOR MATING FACE (RECEPTACLE)



RECEPTACLE  
PC BOARD LAYOUT  
COMPONENT SIDE

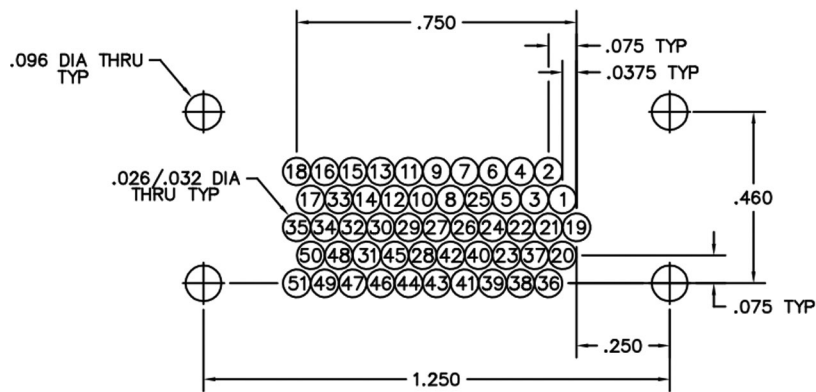
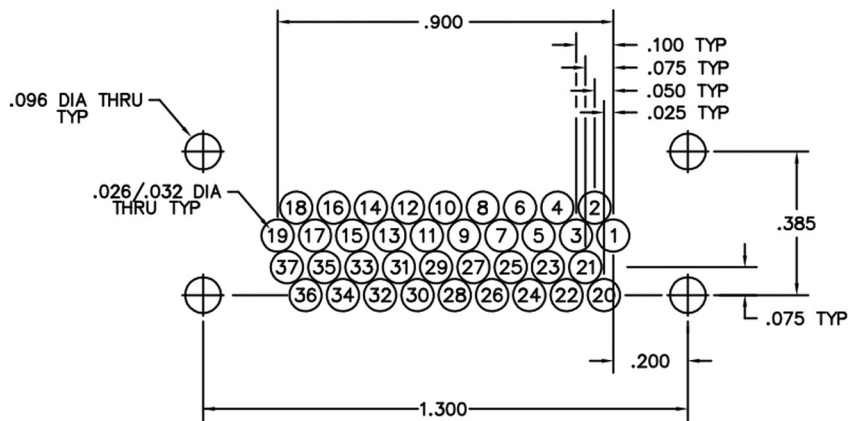
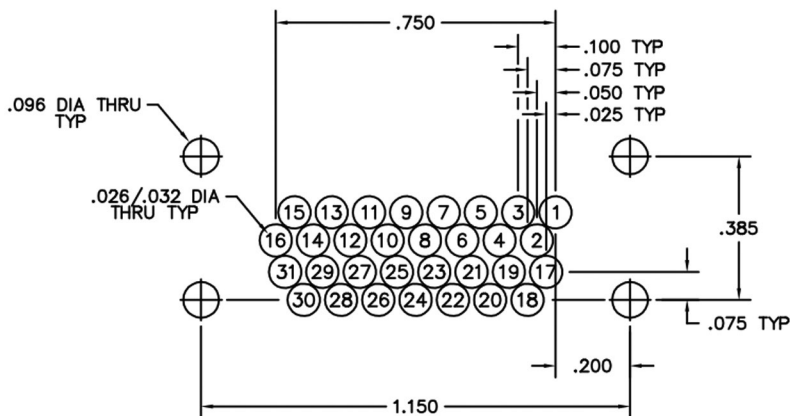





## **"M" SERIES ACCESSORIES**



## Contents

### "M" Series

#### Hardware, Contacts and Accessories

##### Wire Codes, Contacts and Hardware

MA-2	Contacts, contact positions and connector polarization
MA-3, MA-4	Wire codes (24 awg, 26 awg, 28 awg and twisted pairs)
MA-5	Hardware - MM, MN, MP, MQ, MMHT and MQHT
MA-6	Keying hardware
MA-7	Hardware - MM, MQ, EMI and Rear Panel Mount (MM and MK)
MA-8	Hardware - Miscellaneous

##### Accessories

MA-11	Connector savers, rugged (metal - MQ and plastic - MN)
MA-13	Connector savers, low profile (metal - MQ and plastic - MN)
MA-15	EMI/RFI backshells, straight exit, rugged (metal - MM)
MA-17	EMI/RFI backshells, 45° exit, rugged (metal - MM)
MA-19	EMI/RFI backshells, 90° exit, rugged (metal - MM)
MA-21	EMI/RFI backshells, straight exit, low profile (metal - MQ)
MA-23	Dust covers, rugged (metal - MD)
MA-25	ESD dust covers, rugged and low profile (plastic - MD)
MA-26	O-rings and gaskets
MA-27	Rear Panel Mount Hardware
MA-28	Panel cut-outs, MM connectors with grounding fingers

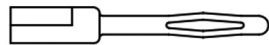

PIN CONTACT  
WITH CRIMP BARREL

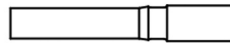

SOCKET CONTACT  
WITH CRIMP BARREL

## Contacts

## Contact Positions

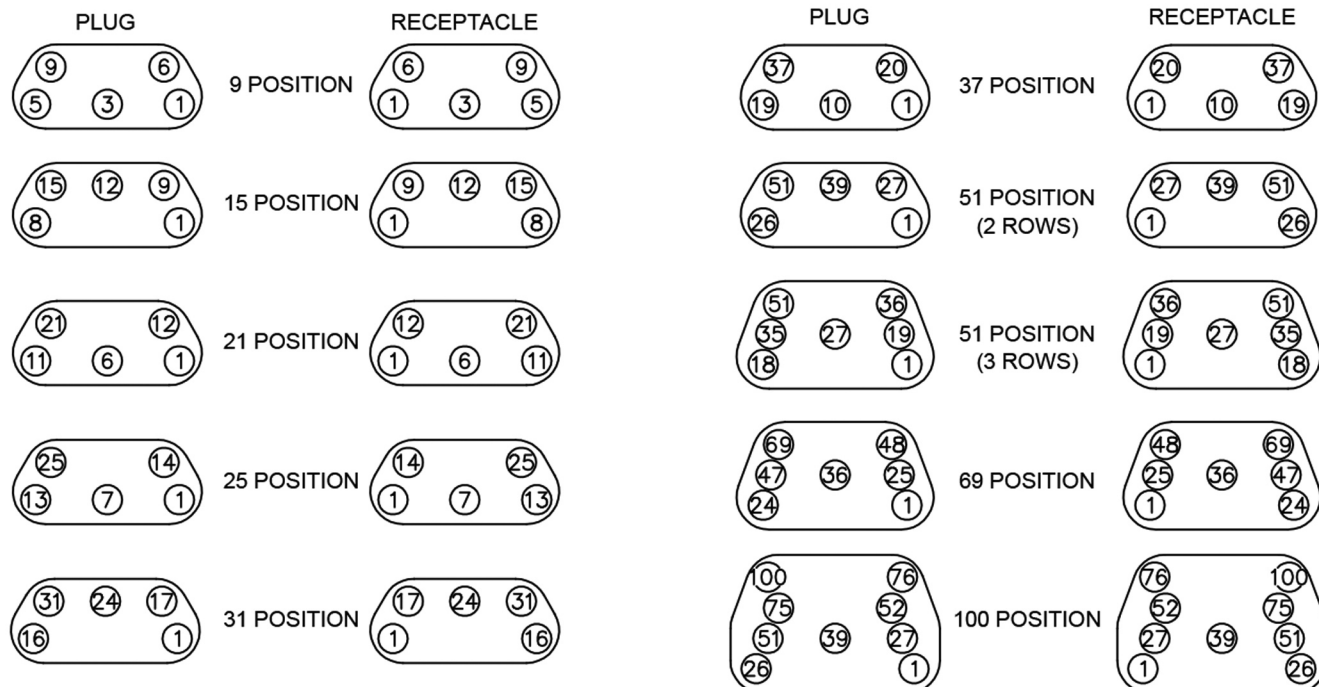

## Hybrid Connectors

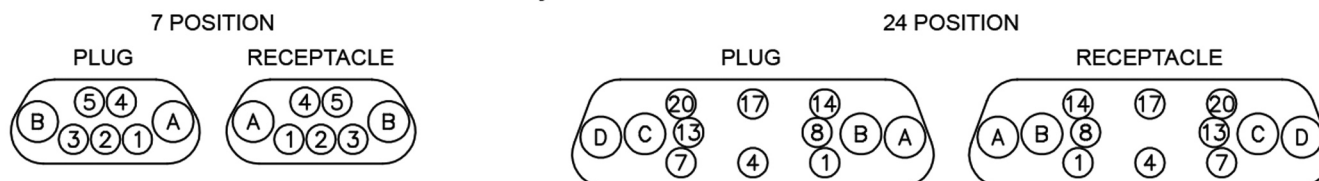

Note: Numbers indicate corner and centermost contacts. Views shown are mating face.

## Connector Polarization



Note: Polarization option applies to PC board mounted, right angle connectors.  
(Series MK, ML, MR & MS)  
Only standard polarization option applies to PC board mounted, right angle,  
high temperature connectors. (Series MKHT, MSHT & MTHT)



## Wire Codes

### NEMA HP3-EXBEB (Formerly M16878/4-24 TFE 7 strand)

	6"	12"	18"	24"	30"	36"	42"	48"	54"	60"	66"	72"	84"	96"	108"	120"
MIL-STD-681*	WA	WB	WC	UD	UE	WD	UG	UH	UJ	UK	UL	UM	UN	UP	UQ	UR
WHITE	WE	WF	WG	VD	VE	WH	VG	VH	VJ	VK	VL	VM	VN	VP	VQ	VR
YELLOW	WJ	WK	WL			WM										

### NEMA HP3-EXBDB (Formerly M16878/4-26 TFE 7 strand)

	6"	12"	18"	24"	30"	36"	42"	48"	54"	60"	66"	72"	84"	96"	108"	120"
MIL-STD-681*	WN	WP	WQ	YD	YE	WR	YG	YH	YJ	YK	YL	YM	YN	YP	YQ	YR
WHITE	WS	WT	WU	ZD	ZE	WV	ZG	ZH	ZJ	ZK	ZL	ZM	ZN	ZP	ZQ	ZR
YELLOW	WW	WX	WY			WZ										

### NEMA HP3-EXBCB (Formerly M16878/4-28 TFE 7 strand)

	6"	12"	18"	24"	30"	36"	42"	48"	54"	60"	66"	72"	84"	96"	108"	120"
MIL-STD-681*	XA	XB	XC	1D	1E	XD	1G	1H	1J	1K	1L	1M	1N	1P	1Q	1R
WHITE	XE	XF	XG	2D	2E	XH	2G	2H	2J	2K	2L	2M	2N	2P	2Q	2R
YELLOW	XJ	XK	XL			XM										

### TWISTED PAIR per NEMA WC27500-XXRC2U00 (SAE AS22759/11)

	6"	12"	18"	24"	30"	36"	42"	48"	54"	60"	66"	72"	84"	96"	108"	120"
24 AWG	AA	AB	AC	AD	AE	AF	AG	AH	AJ	AK	AL	AM	AN	AP	AQ	AR
26 AWG	BA	BB	BC	BD	BE	BF	BG	BH	BJ	BK	BL	BM	BN	BP	BQ	BR

### TWISTED PAIR per NEMA WC27500-XXSC2U00 (SAE AS22759/33)\*\*\* ☒

	6"	12"	18"	24"	30"	36"	42"	48"	54"	60"	66"	72"	84"	96"	108"	120"
24 AWG	JA	JB	JC	JD	JE	JF	JG	JH	JJ	JK	JL	JM	JN	JP	JQ	JR
26 AWG	KA	KB	KC	KD	KE	KF	KG	KH	KJ	KK	KL	KM	KN	KP	KQ	KR

For twisted pair wire connect charts, see page MA-9  
 Twisted pair wire not available on MA, MC or Hybrid connectors

\* = Connectors with more than 100 contacts will repeat color code after 100 colors.

\*\*\* = Per M83513, corrosion has been experienced on connectors that are pre-wired with 22759/33 and stored in sealed environments.  
 Caution should be exercised when using this wire.

☒ = Option not RoHS compliant

## Wire Codes

### SAE AS22759/11-24

	6"	12"	18"	24"	30"	36"	42"	48"	54"	60"	66"	72"	84"	96"	108"	120"
M83513**	5A	5B	5C	5D	5E	5F	5G	5H	5J	5K	5L	5M	5N	5P	5Q	5R
MIL-STD-681*	CA	CB	CC	CD	CE	CF	CG	CH	CJ	CK	CL	CM	CN	CP	CQ	CR
WHITE	DA	DB	DC	DD	DE	DF	DG	DH	DJ	DK	DL	DM	DN	DP	DQ	DR

### SAE AS22759/11-26

	6"	12"	18"	24"	30"	36"	42"	48"	54"	60"	66"	72"	84"	96"	108"	120"
M83513**	6A	6B	V1	6D	6E	V2	6G	6H	6J	6K	6L	Y6	6N	6P	6Q	6R
MIL-STD-681*	X3	X4	W3	ED	EE	W4	EG	EH	EJ	EK	EL	EM	EN	EP	EQ	ER
WHITE	X1	X2	W1	FD	FE	W2	FG	FH	FJ	FK	FL	Y5	FN	FP	FQ	FR

### SAE AS22759/33-24\*\*\* ☒

	6"	12"	18"	24"	30"	36"	42"	48"	54"	60"	66"	72"	84"	96"	108"	120"
M83513**	LA	LB	LC	LD	LE	LF	LG	LH	LJ	LK	LL	LM	LN	LP	LQ	LR
WHITE	MA	MB	MC	MD	ME	MF	MG	MH	MJ	MK	ML	MM	MN	MP	MQ	MR

### SAE AS22759/33-26\*\*\* ☒

	6"	12"	18"	24"	30"	36"	42"	48"	54"	60"	66"	72"	84"	96"	108"	120"
M83513**	NA	NB	Y3	ND	NE	Y4	NG	NH	NJ	NK	NL	Y8	NN	NP	NQ	NR
WHITE	PA	PB	Y1	PD	PE	Y2	PG	PH	PJ	PK	PL	Y7	PN	PP	PQ	PR

\* = Connectors with more than 100 contacts will repeat color code after 100 colors.

\*\* = Wire colors per M83513 are ten solid colors repeating.

\*\*\* = Per M83513, corrosion has been experienced on connectors that are pre-wired with 22759/33 and stored in sealed environments.  
Caution should be exercised when using this wire.

☒ = Option not RoHS compliant

# Hardware

## MM - MN - MQ - MP - MMHT - MQHT Jacking Hardware

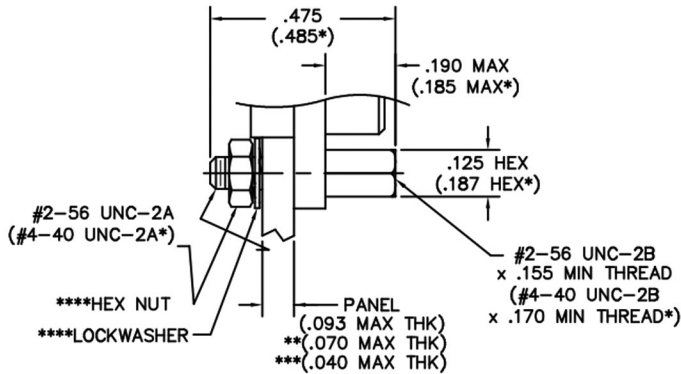

JACKPOST ASSEMBLY

#2-56 JACKPOST	00-000-000-000-2200
#4-40 JACKPOST	00-000-000-000-6200
<u>FOR RECEPTACLES WITH GROUNDING FINGERS</u>	
#2-56 JACKPOST	00-000-000-000-2200-0G7
#4-40 JACKPOST	00-000-000-000-6200-0G7

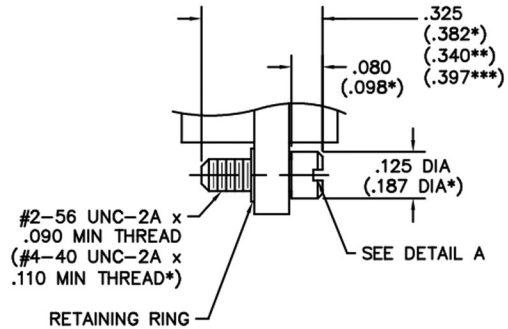

SHORT TURNING  
JACKSCREW ASSEMBLY

#2-56 JACKSCREW, ALLEN HEAD	00-000-000-000-4100
#2-56 JACKSCREW, SLOT HEAD	00-000-000-000-4300
#4-40 JACKSCREW, ALLEN HEAD	00-000-000-000-8100
#4-40 JACKSCREW, SLOT HEAD	00-000-000-000-8300

<u>FOR RECEPTACLES WITH GROUNDING FINGERS</u>	
#2-56 JACKSCREW, ALLEN HEAD	00-000-000-000-4100-0G7
#2-56 JACKSCREW, SLOT HEAD	00-000-000-000-4300-0G7
#4-40 JACKSCREW, ALLEN HEAD	00-000-000-000-8100-0G7
#4-40 JACKSCREW, SLOT HEAD	00-000-000-000-8300-0G7

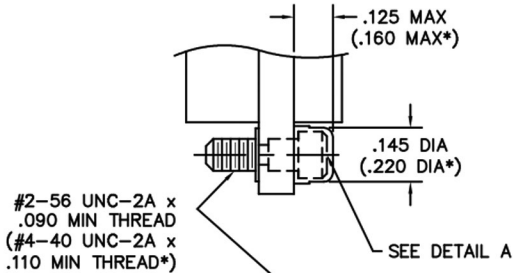

SHORT CAPTIVE  
JACKSCREW ASSEMBLY

JACKSCREW, ALLEN HEAD  
FACTORY INSTALLED ONLY

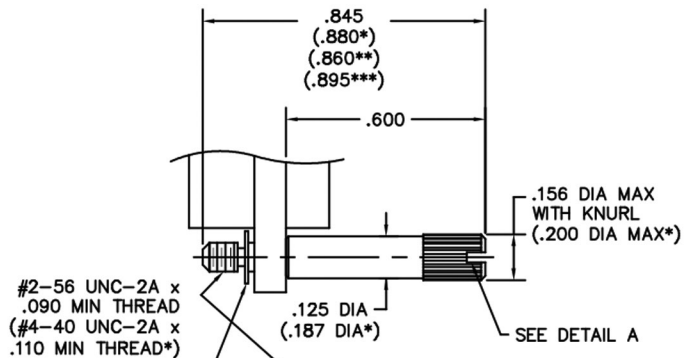

LONG TURNING  
JACKSCREW ASSEMBLY

#2-56 JACKSCREW, ALLEN HEAD	00-000-000-000-4200
#2-56 JACKSCREW, SLOT HEAD	00-000-000-000-4400
#4-40 JACKSCREW, ALLEN HEAD	00-000-000-000-8200
#4-40 JACKSCREW, SLOT HEAD	00-000-000-000-8400

<u>FOR RECEPTACLES WITH GROUNDING FINGERS</u>	
#2-56 JACKSCREW, ALLEN HEAD	00-000-000-000-4200-0G7
#2-56 JACKSCREW, SLOT HEAD	00-000-000-000-4400-0G7
#4-40 JACKSCREW, ALLEN HEAD	00-000-000-000-8200-0G7
#4-40 JACKSCREW, SLOT HEAD	00-000-000-000-8400-0G7

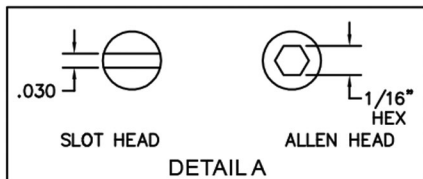

\* = Dimensions for 100 position connectors  
 \*\* = Applies to #2-56 hardware for receptacles with grounding fingers  
 \*\*\* = Applies to #4-40 hardware for receptacles with grounding fingers  
 \*\*\*\* = Hardware for Receptacles with Grounding Fingers will come with a flat washers, lockwashers, and spanner nuts

## Polarized Keying Hardware

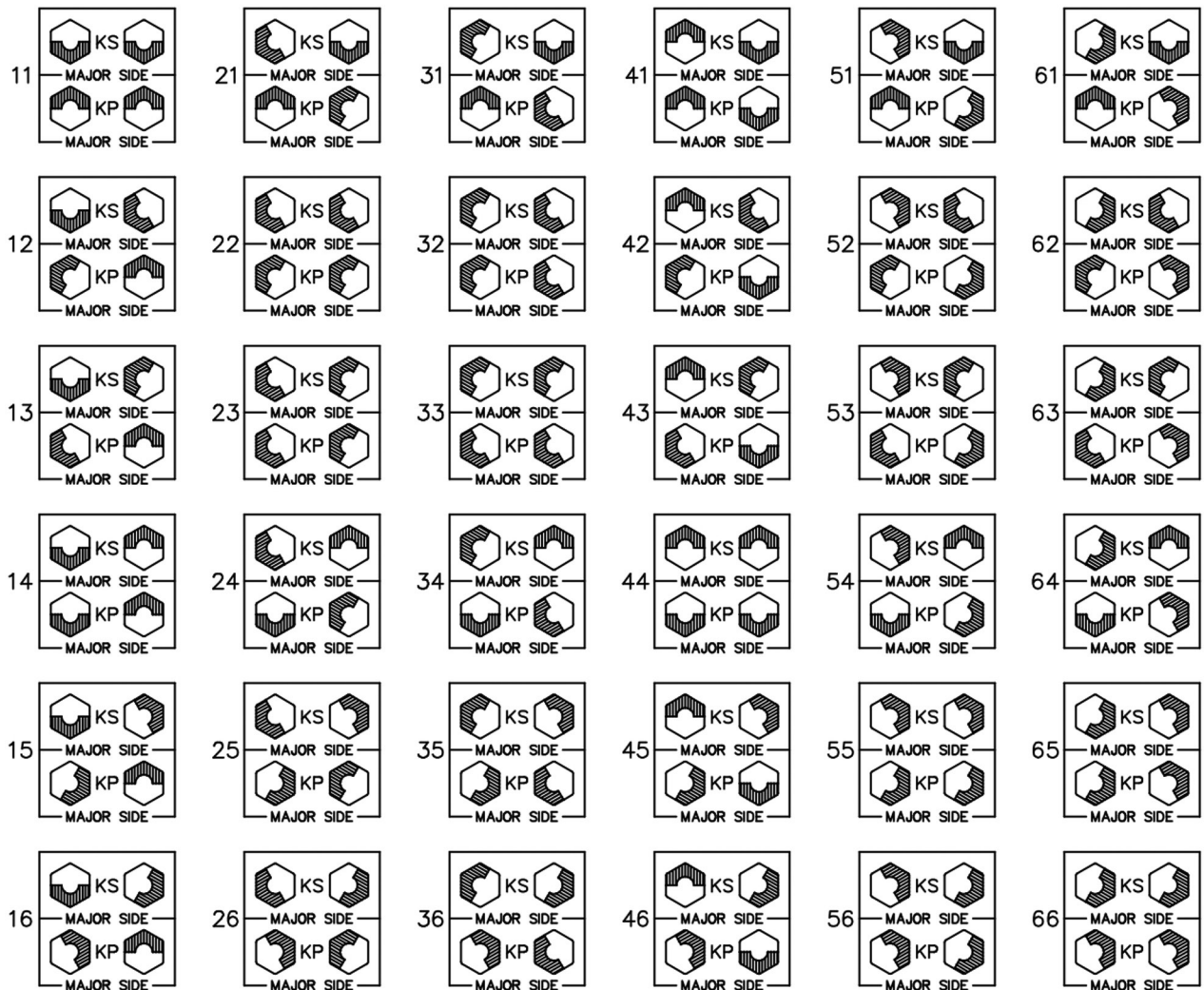

Select the appropriate two digit number above and include as the last two digits of the hardware code in the part number.  
(Keying hardware is factory installed and non-removable).

Example:

MM-213-025-161-99WA-KS11

MK-263-025-435-990S-KP11

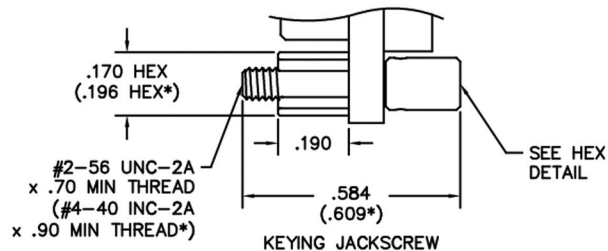
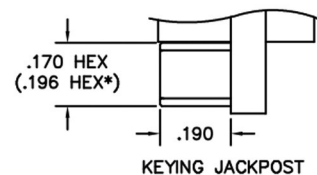
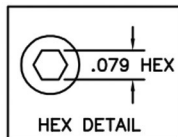
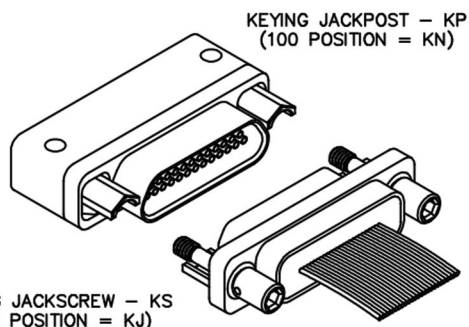

\* = Dimensions for 100 position connectors

## Hardware

### MM - MQ I/O with EMI/RFI Backshell

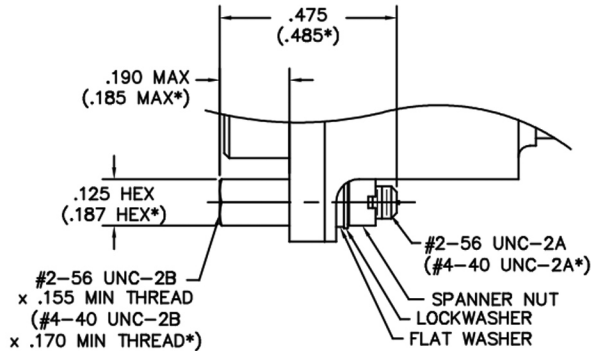

JACKPOST ASSEMBLY

- #2-56 JACKPOST 00-000-000-000-2200-01G
- #4-40 JACKPOST 00-000-000-000-6200-04A

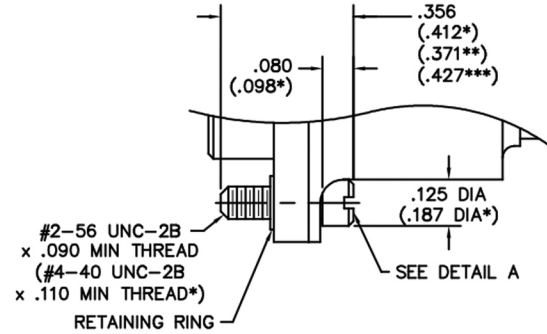

SHORT TURNING  
JACKSCREW ASSEMBLY

- #2-56 JACKSCREW, ALLEN HEAD 00-000-000-000-4100-01G
- #2-56 JACKSCREW, SLOT HEAD 00-000-000-000-4300-01G
- #4-40 JACKSCREW, ALLEN HEAD 00-000-000-000-8100-04A
- #4-40 JACKSCREW, SLOT HEAD 00-000-000-000-8300-04A

FOR RECEPTACLES WITH GROUNDING FINGERS

- #2-56 JACKSCREW, ALLEN HEAD 00-000-000-000-4100-0FZ
- #2-56 JACKSCREW, SLOT HEAD 00-000-000-000-4300-0FZ
- #4-40 JACKSCREW, ALLEN HEAD 00-000-000-000-8100-0FZ
- #4-40 JACKSCREW, SLOT HEAD 00-000-000-000-8300-0FZ

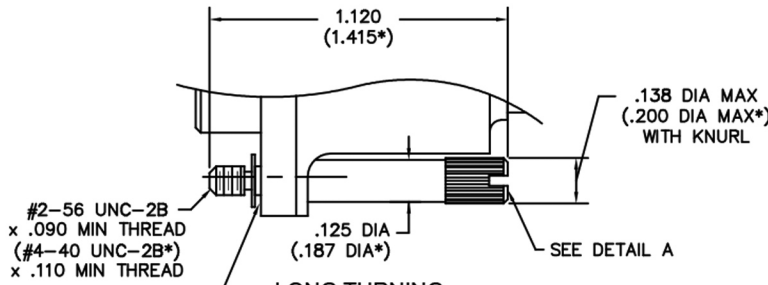

LONG TURNING  
JACKSCREW ASSEMBLY

- #2-56 JACKSCREW, SLOT HEAD 00-000-000-000-4400-01G
- #4-40 JACKSCREW, SLOT HEAD 00-000-000-000-8400-04A

FOR RECEPTACLES WITH GROUNDING FINGERS

- #2-56 JACKSCREW, SLOT HEAD 00-000-000-000-4400-0FZ
- #4-40 JACKSCREW, SLOT HEAD 00-000-000-000-8400-0FZ

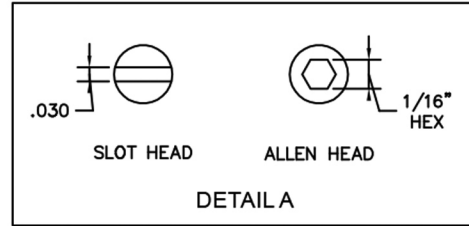

- \* = Dimensions for #4-40 hardware (100 position connectors)
- \*\* = Applies to #2-56 hardware for receptacles with grounding fingers
- \*\*\* = Applies to #4-40 hardware for receptacles with grounding fingers

### MM - MK Rear Panel Mount Jackposts for Body Styles "A", "C", "E", "H", "K", and "L"

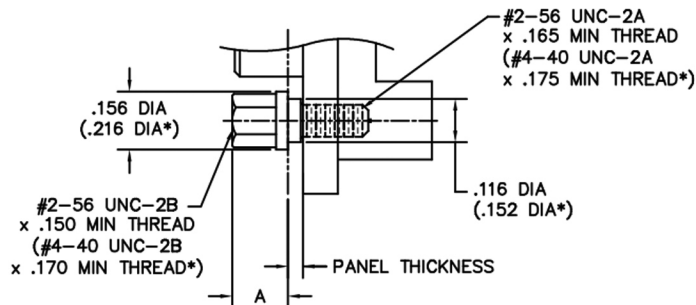

PANEL THK	THREAD SIZE	PART NUMBER	A MAX
.040	#2-56	MM-000-000-000-2400-0D1	.150
.060		MM-000-000-000-2600-0D3	.130
.070		MM-000-000-000-2800-0D5	.120
.080		MM-000-000-000-2900-0D7	.110
.040		MM-000-000-000-6400-0D2	.150
.060	#4-40	MM-000-000-000-6600-0D4	.130
.070		MM-000-000-000-6800-0D6	.120
.080		MM-000-000-000-6900-0D8	.110

\* = Dimensions for 100 position connectors

## Hardware

### MK Vertical SMT

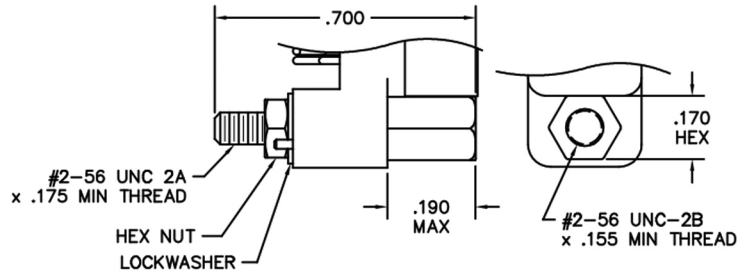

JACKPOST ASSEMBLY  
FACTORY INSTALLED ONLY

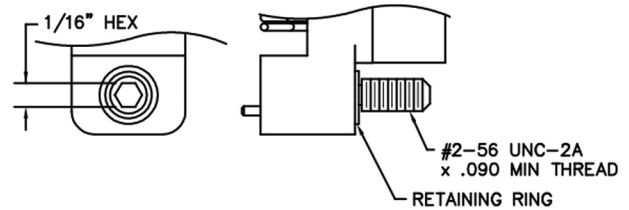

TURNING JACKSCREW ASSEMBLY  
FACTORY INSTALLED ONLY

### MK - MS MKHT - MSHT

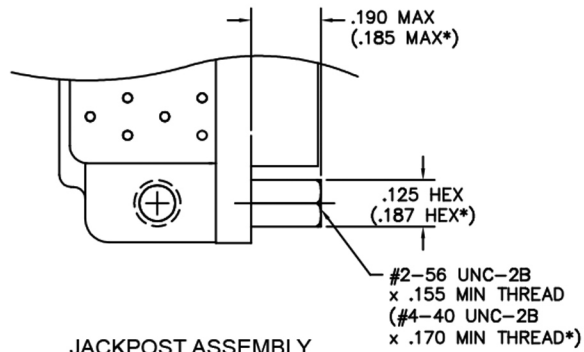

JACKPOST ASSEMBLY  
CONSULT FACTORY

### MTHT

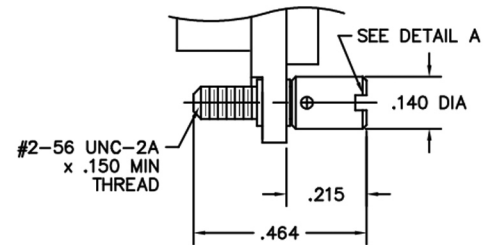

JACKSCREW ASSEMBLY  
FACTORY INSTALLED ONLY

\* = Dimensions for 100 position connectors

### MA

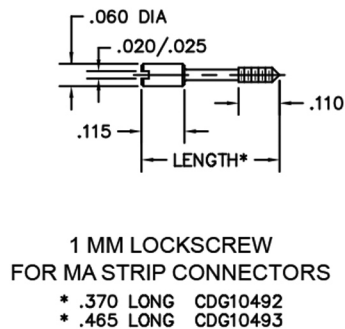

### Mounting Bracket

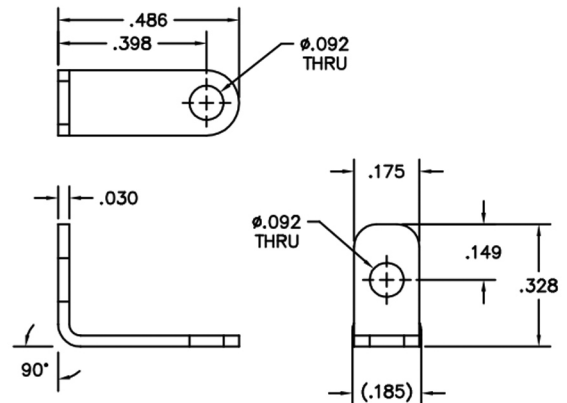

CDG12633 - 2 EACH

## Twisted Pair Wire Connect Charts

9 POSITION

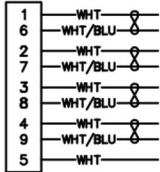

15 POSITION

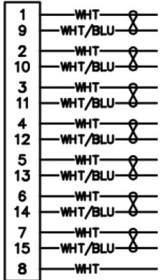

51 POSITION  
2 rows

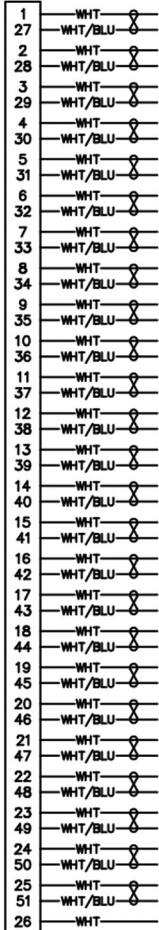

51 POSITION  
3 rows

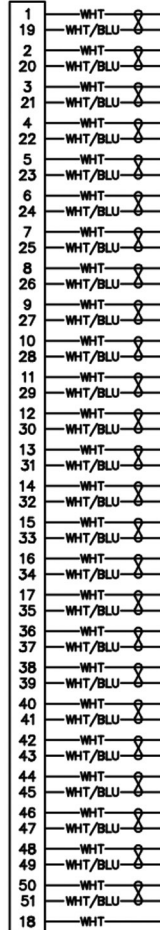

69 POSITION

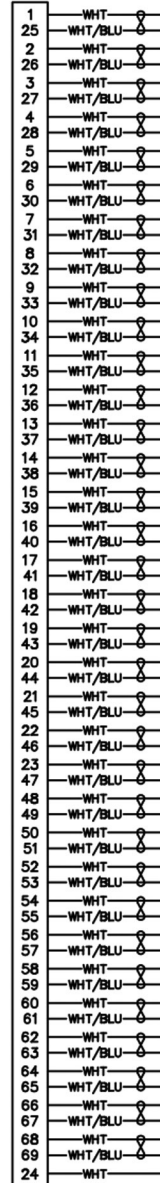

21 POSITION

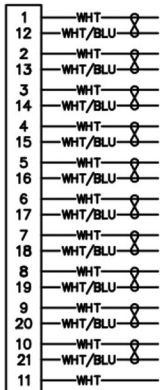

25 POSITION

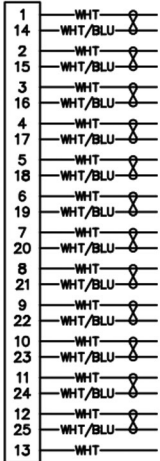

37 POSITION

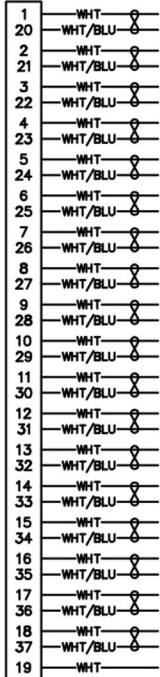

31 POSITION

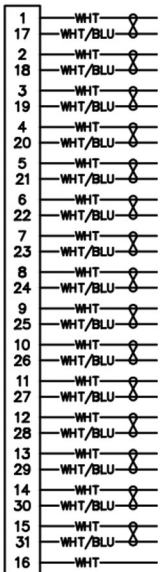

100 POSITION

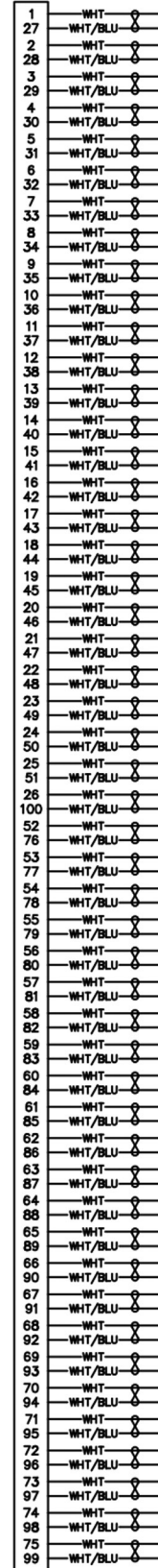

## Panel Mounting Dimensions

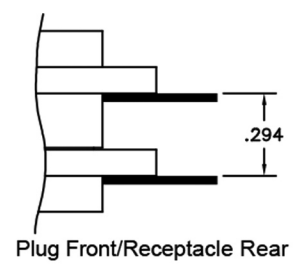
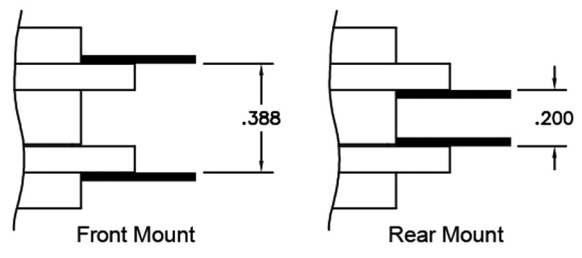

MOUNTING DIMENSIONS

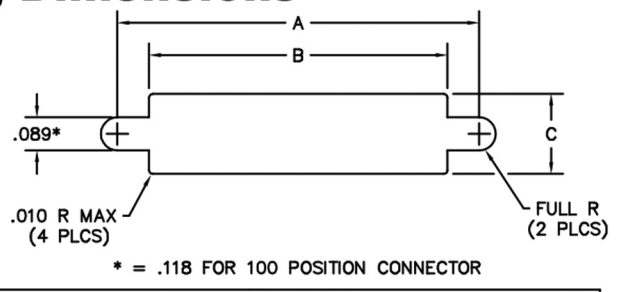

DIMENSIONS					
CONTACT ROWS	SIZE	A +.004 -.000	B +.005 -.000	C +.004 -.000	
				MP, MQ, MR, MS MQHT, MSHT	MK, ML, MM, MN MKHT, MMHT
2	9	.570	.400	.215	.273
	15	.720	.550		
	21	.870	.700		
	25	.970	.800		
	31	1.120	.950		
	37	1.270	1.100		
3	51	1.620	1.450	.256	.311
	69	1.520	1.350		
4	100	1.805	1.435	—	.383

## Panel Mounting Dimensions for Rear Panel Mount Connectors

RUGGED METAL  
MM, MN, MK, ML  
SIZES: 9 - 69

DIMENSIONS			
SIZE	A +.004 -.000	B +.005 -.000	C ±.005
9	.401	.252	.565
15	.551		.715
21	.701		.865
25	.801		.965
31	.951		1.115
37	1.101		1.265
51	1.451	.295	1.615
51	1.051		1.215
69	1.351		1.515

LOW PROFILE  
MQ, MP, MS, MR  
SIZES: 9 - 51

DIMENSIONS			
SIZE	A +.004 -.000	B +.005 -.000	C ±.005
9	.379	.219	.565
15	.529		.715
21	.679		.865
25	.779		.965
31	.929		1.115
37	1.079		1.265
51	1.029	.261	1.215

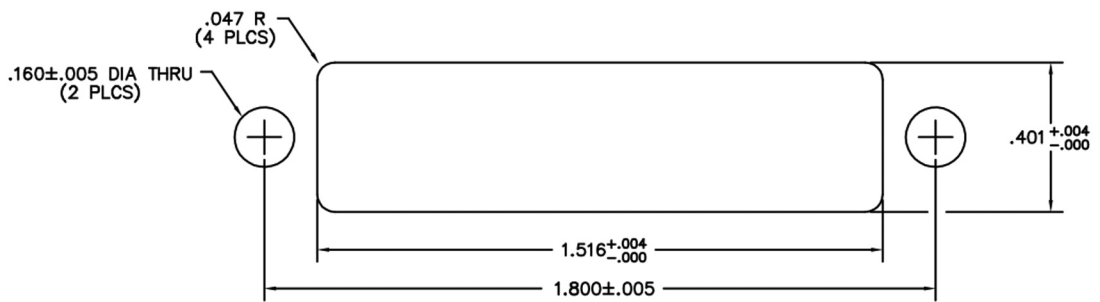
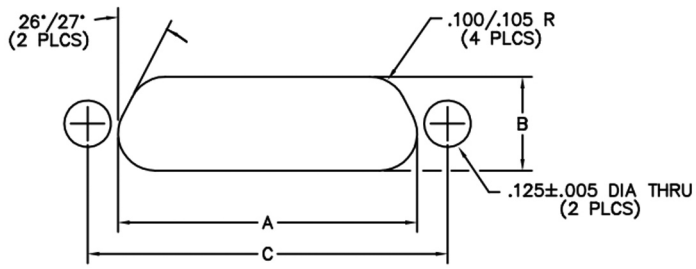

RUGGED METAL  
MM, MN, MK, ML  
SIZE 100



# Connector Saver

**.050"**

**9 thru 100 Contacts**

**Rugged Metal**

**MM**

**Rugged Plastic**

**MN**

MM-212-031-143-2200-93A  
(METAL)

MN-211-031-143-2200-93A  
(PLASTIC)

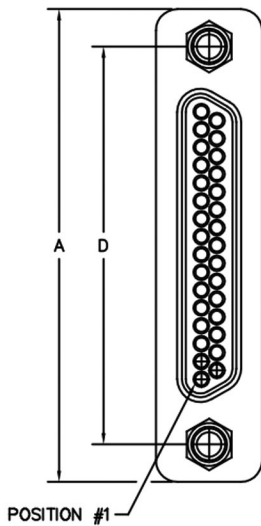
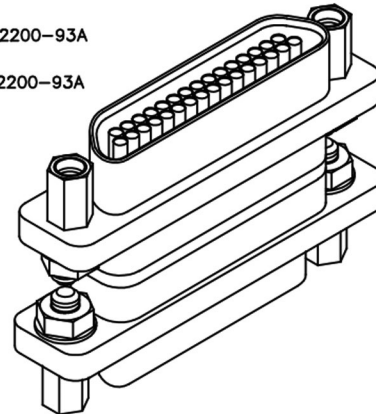

PLUG

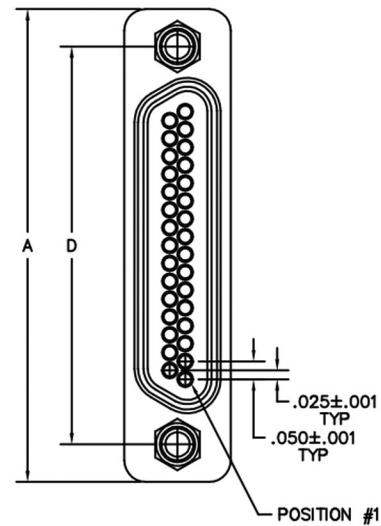
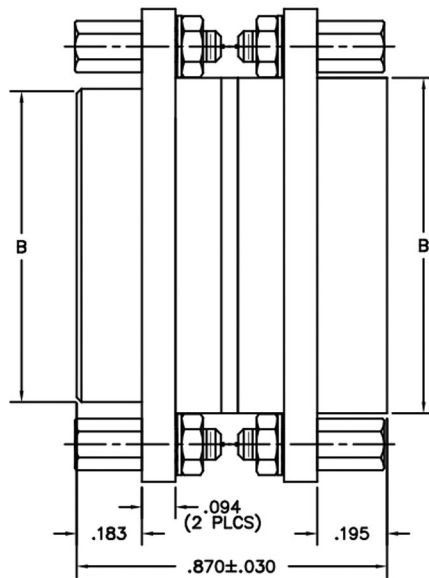

RECEPTACLE

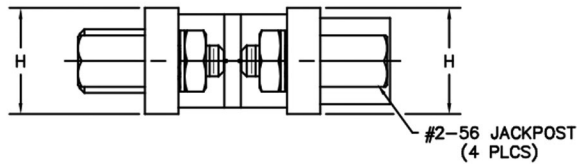

SIZE	CONTACT ROWS	DIMENSIONS					HARDWARE
		A	B		D	H	
			PLUG MAX	RCPT MAX			
9	2	.775	.334	.400	.565	.298	#2-56 UNC THD (.092 DIA THRU)
15		.925	.484	.550	.715		
21		1.075	.634	.700	.865		
25		1.175	.734	.800	.965		
31		1.325	.884	.950	1.115		
37		1.475	1.034	1.100	1.265		
51**	3	1.825	1.384	1.450	1.615	.341	#4-40 UNC THD (.147 DIA THRU)
51		1.425	.984	1.050	1.215		
69***		1.725	1.284	1.350	1.515		
100	4	2.160	1.384	1.508	1.800	.384	#4-40 UNC THD (.147 DIA THRU)

\*\* = 2 ROW, 51 POSITION CONNECTORS ARE AVAILABLE IN METAL ONLY (NON MIL-SPEC INTERFACE)  
\*\*\* = 69 POSITION CONNECTORS ARE AVAILABLE IN METAL ONLY.

PLUG/RECEPTACLE: MM-212-031-143-2200-93A  
 MN-211-031-143-2200-93A  
 XX-XXX-XXX-XXX-XXXX-XXX

<b>SERIES</b>	
MM	.050" Rugged Metal
MN	.050" Rugged Plastic
<b>BODY</b>	
2	2-Row (Sizes 9 thru 51**)
3	3-Row (Size 51 & 69***)
4	4-Row (Size 100)
BODY STYLE:	
1	Plug/Receptacle, straight with mounting ears, receptacle includes interfacial sealing gasket
BODY MATERIAL:	
1	Polyphenylene Sulfide (MN only)
2	Polyphenylene Sulfide with electroless nickel shell
3	Polyphenylene Sulfide with electrodeposited cadmium shell <input checked="" type="checkbox"/>
4	Polyphenylene Sulfide with hard anodized black shell
<b>SIZE</b>	
XXX	009, 015, 021, 025, 031, 037, 051**, 069***, 100
<b>CONTACTS</b>	
TYPE CONTACTS/TERMINATIONS:	
14	Pin/Socket, straight
PLATING OPTIONS:	
3	50 μ" Au contacts: 10 μ" Au terminations
<b>HARDWARE</b>	
STYLE OF HARDWARE:	
00	None
22	Two fixed jacknut assemblies (62*)
JA	Turning jackpost with retaining ring, uninstalled (PA*)
JP	Turning jackpost, internal thread on plug side (PP*)
JS	Turning jackpost, internal thread on receptacle side (PS*)
POLARIZATION / WIRING:	
00	None
<b>SPECIAL DESIGNATORS</b>	
93A	Connector saver designator

\* = Use number in parenthesis when ordering size 100.  
 \*\* = 2 row, 51 position connectors are available in metal only (non mil-spec interface)  
 \*\*\* = 69 position connectors are available in metal only.  
 = Option not RoHS compliant

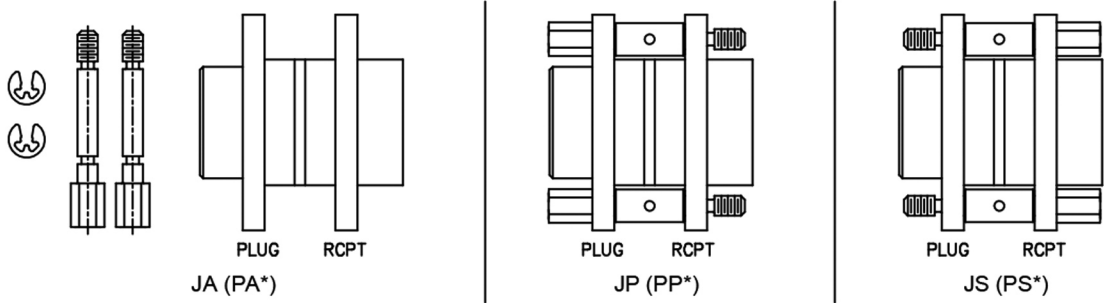



# Connector Saver

**.050"**

**9 thru 51 Contacts**

**Low Profile Metal**

**MQ**

**Low Profile Plastic**

**MP**

MQ-212-031-143-2200-93A  
(METAL)

MP-211-031-143-2200-93A  
(PLASTIC)

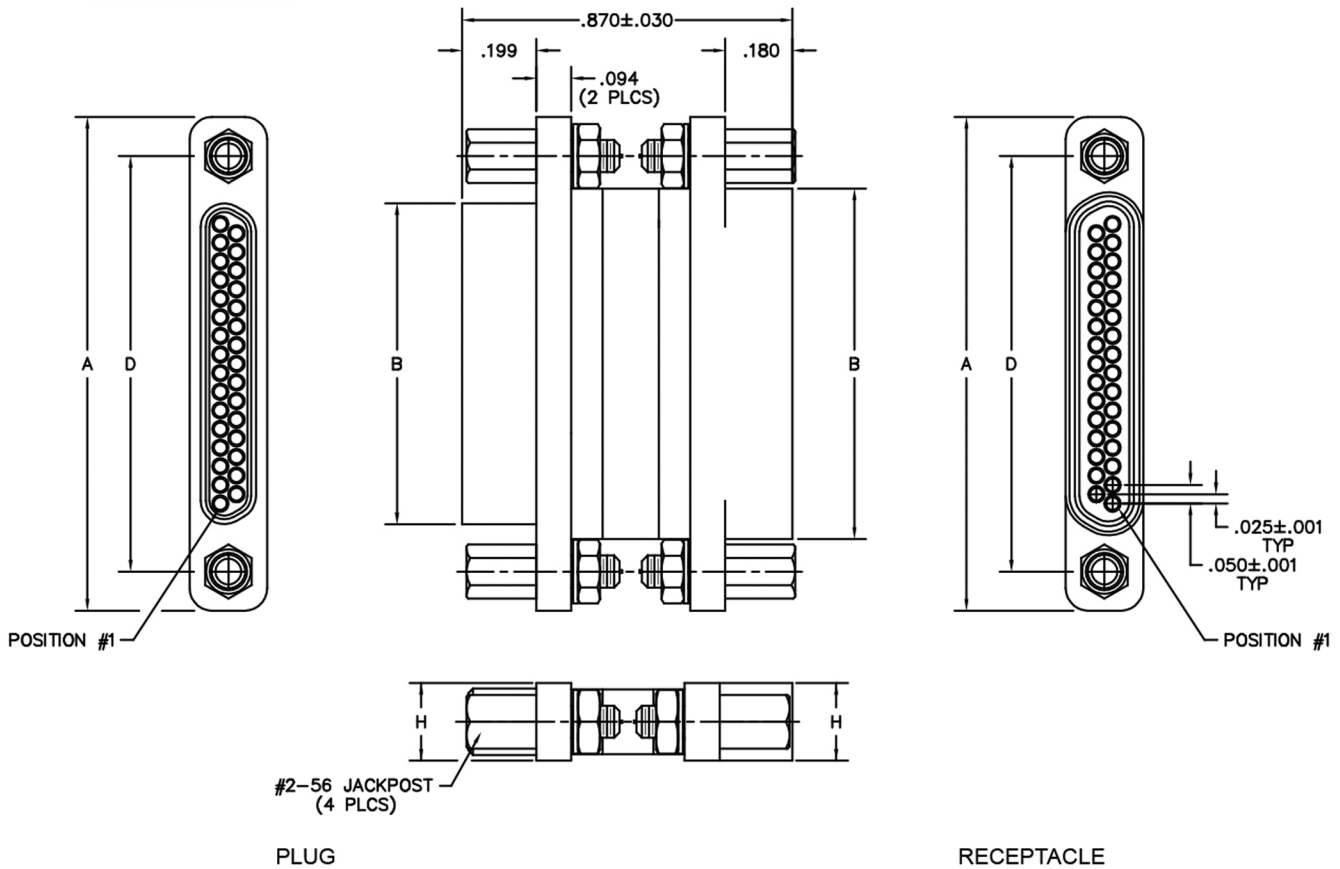
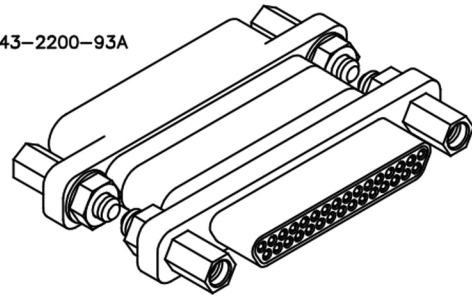

SIZE	CONTACT ROWS	DIMENSIONS					HARDWARE
		A	B		D	H ±.005	
			PLUG MAX	RCPT MAX			
9	2	.778	.292	.378	.565	.208	#2-56 UNC THD (.092 DIA THRU)
15		.928	.442	.528	.715		
21		1.078	.592	.678	.865		
25		1.178	.692	.778	.965		
31		1.328	.842	.928	1.115		
37		1.478	.992	1.078	1.265		
51	3	1.428	.942	1.028	1.215	.250	



PLUG/RECEPTACLE: MQ-212-031-143-2200-93A  
 MP-211-031-143-2200-93A  
 XX-XXX-XXX-XXX-XXXX-XXX

<b>SERIES</b>	
MQ	.050" Low Profile Metal
MP	.050" Low Profile Plastic
<b>BODY</b>	
2	2-Row (Sizes 9 thru 37)
3	3-Row (Size 51)
BODY STYLE:	
1	Plug/Receptacle, straight with mounting ears
BODY MATERIAL:	
1	Polyphenylene Sulfide (MN only)
2	Polyphenylene Sulfide with electroless nickel shell
3	Polyphenylene Sulfide with electrodeposited cadmium shell <input checked="" type="checkbox"/>
4	Polyphenylene Sulfide with hard anodized back shell
<b>SIZE</b>	
XXX	009, 015, 021, 025, 031, 037, 051
<b>CONTACTS</b>	
TYPE CONTACTS/TERMINATIONS:	
14	Pin/Socket, straight
PLATING OPTIONS:	
3	50 μ" Au contacts: 10 μ" Au terminations
<b>HARDWARE</b>	
STYLE OF HARDWARE:	
00	None
22	Two fixed jacknut assemblies
JA	Turning jackpost with retaining ring, uninstalled
JP	Turning jackpost, internal thread on plug side
JS	Turning jackpost, internal thread on receptacle side
POLARIZATION / WIRING:	
00	None
<b>SPECIAL DESIGNATORS</b>	
93A	Connector saver designator

= Option not RoHS compliant

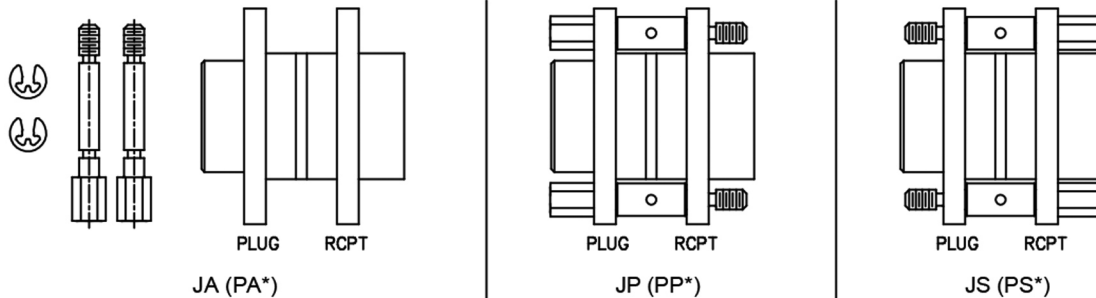



# EMI/RFI Straight Backshells

**.050"**  
**9 thru 100 Contacts**

**Rugged Metal**

**MM**

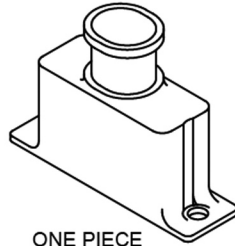

ONE PIECE  
(POSITIONS 9-100)

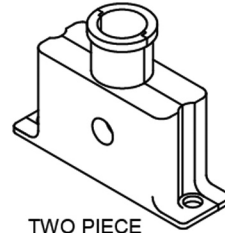

TWO PIECE  
(POSITIONS 9 & 15)

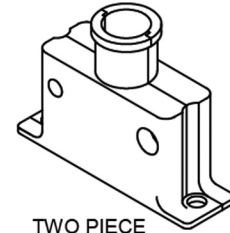

TWO PIECE  
(POSITIONS 21-100)

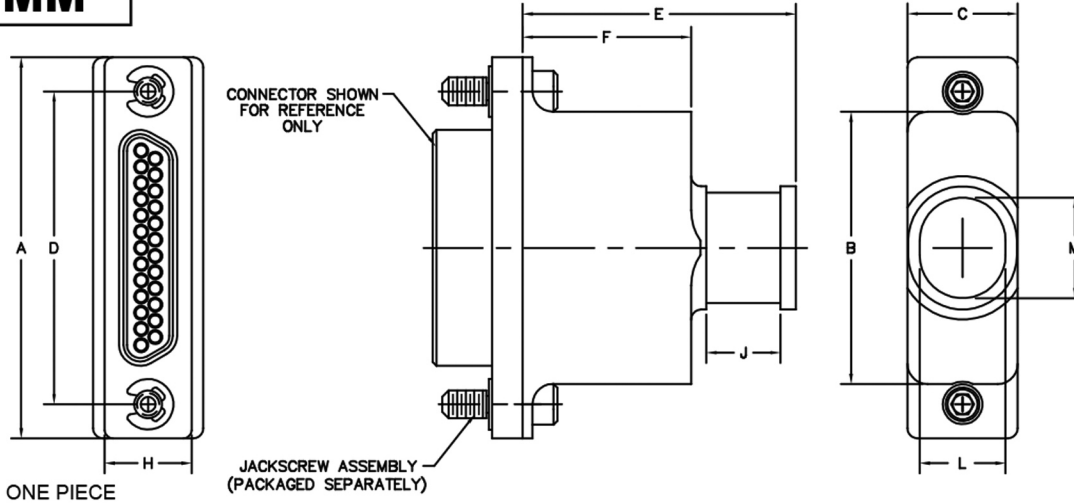

DIMENSIONS													
SIZE	CONTACT ROWS	A	B	C	D	E	F	H	J	L	M	HARDWARE	
9	2	.775	.440	.340	.565	.843	.520	.298	.229	SEE TABLE A ON PART# SHT		#2-56 UNC THD (.092 DIA THRU)	
15		.925	.590		.715								
21		1.075	.740		.865								
25		1.175	.840		.965								
31		1.325	.990		1.115								
37		1.475	1.140		1.265								
51	3	1.825	1.490	.380	1.615	.933	.610	.341				#4-40 UNC THD (.147 DIA THRU)	
51		1.425	1.090		1.215								
69		1.725	1.390		1.515								
100	4	2.160	1.522	.430	1.800	.953	.630	.384					

TWO PIECE

DIMENSIONS												
SIZE	CONTACT ROWS	A	B	C	D	E	F	H	J	L	M	HARDWARE
9	2	.775	.480	.340	.565	.843	.520	.298	.229	SEE TABLE B ON PART# SHT		#2-56 UNC THD (.092 DIA THRU)
15		.925	.630		.715							
21		1.075	.780		.865							
25		1.175	.880		.965							
31		1.325	1.030		1.115							
37		1.475	1.180		1.265							
51	3	1.825	1.530	.380	1.615	.933	.610	.341				#4-40 UNC THD (.147 DIA THRU)
51		1.425	1.130		1.215							
69		1.725	1.430		1.515							
100	4	2.160	1.528	.430	1.800	.953	.630	.384				



RUGGED: MM-252-031-000-4100  
XX-XXX-XXX-XXX-XXXX-XXX

<b>SERIES</b>	
MM	.050" Rugged Metal Backshell
<b>BODY</b>	
2	2-Row (Sizes 9 thru 51)
3	3-Row (Sizes 51 & 69)
4	4-Row (Size 100)
BODY STYLE:	
3	Straight, one piece
5	Straight, two piece***
BODY MATERIAL:	
2	Aluminum, with electroless nickel plating
3	Aluminum, with electrodeposited cadmium <input checked="" type="checkbox"/>
4	Aluminum, with hard anodized black plating
<b>SIZE</b>	
XXX	009, 015, 021, 025, 031, 037, 051, 069, 100
<b>EXIT</b>	
000	Standard exit, see Table A
AAA	Large exit, see Table A**
BBB	Small exit, see Table A**
<b>HARDWARE</b>	
STYLE OF HARDWARE:	
00	None
22	Two fixed jacknut assemblies (62*)
41	Two turning jackscrews, allen head, retaining ring (81*)
43	Two turning jackscrews, slot head, retaining ring (83*)
44	Two long turning jackscrews, slot head, retaining ring (84*)
POLARIZATION / WIRING:	
00	None
<b>OPTIONS</b>	
0FZ	Required for receptacles with grounding fingers when ordering hardware styles 41, 43, 44, 81, 83, & 84

\* = Use number in parenthesis when ordering size 100.  
 \*\* = Available with Body Style 3 (one piece) only.  
 \*\*\* = Sizes 9 and 15 not recommended for solder cup applications or 24 AWG wire applications.

Stainless steel micro band for shield termination - AirBorn part number CDG10026, shipped with each backshell  
 Band-it application tool - AirBorn part number CDG10027

= Option not ROHS compliant

TABLE A (ONE PIECE)

EXIT DIMENSIONS						
SIZE	000		AAA		BBB	
	L	M	L	M	L	M
9	—	.188	.265	.310	—	.129
15	—	.230		.458	—	.162
21	.265	.257		.608	—	.188
25		.310		.708	—	.206
31		.330		.858	—	.225
37		.375	1.008	—	.242	
51		.515	1.034	.265	.300	
51	.297	.470	.921	—	.290	
69		.620	1.158	.297	.361	
100		.344	.688	.344	1.342	.344

TABLE B (TWO PIECE)

EXIT DIMENSIONS		
SIZE	000	
	L	M
9	—	.188
15	—	.230
21	.240	.268
25		.325
31		.346
37		.396
51		.554
51	.280	.492
69		.635
100		.711



**EMI/RFI 45°  
Backshells**  
**.050"**  
**9 thru 100 Contacts**  
**Rugged Metal**

**MM**

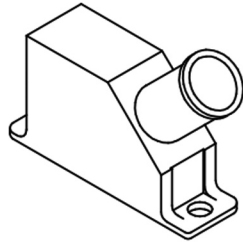

MM, 45°  
(ONE PIECE)

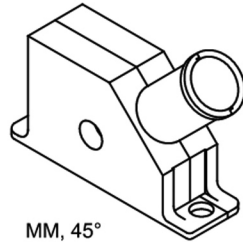

MM, 45°  
(TWO PIECE)  
(POSITIONS 9 & 15)

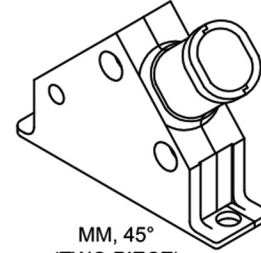

MM, 45°  
(TWO PIECE)  
(POSITIONS 21 - 100)

Note: 21 & 25 position, 2 piece backshells use two screw clamping configurations.

MM, 45° (ONE PIECE)

DIMENSIONS													
SIZE	CONTACT ROWS	A	B	C	D	E	F	H	J	K	L	M	HARDWARE
9	2	.775	.440	.340	.565	.696	.500	.298	.229	.804	—	.188	#2-56 UNC THD (.092 DIA THRU)
15		.925	.590		.715	.721	.525			.954	—	.230	
21		1.075	.740		.865	.746	.550			1.103	—	.257	
25		1.175	.840		.965	.796	.600			1.203	—	.310	
31		1.325	.990		1.115	.846	.650			1.353	.265	.330	
37		1.475	1.140		1.265	.921	.725			1.503	—	.375	
51	3	1.825	1.490	.380	1.615	1.144	.950	.341	.229	1.853	—	.510	#2-56 UNC THD (.092 DIA THRU)
51		1.425	1.090		1.215	.946	.750			1.453	.297	.470	
69		1.725	1.390		1.515	—	—			1.753	—	.620	
100	4	2.160	1.522	.430	1.800	1.146	.950	.384	—	2.036	.344	.688	#4-40 UNC THD (.147 DIA THRU)

MM, 45° (TWO PIECE)

DIMENSIONS													
SIZE	CONTACT ROWS	A	B	C	D	E	F	H	J	K	L	M	HARDWARE
9	2	.775	.480	.340	.565	.855	.650	.298	.229	.806	—	.188	#2-56 UNC THD (.092 DIA THRU)
15		.925	.630		.715	.831	.625			.944	—	.230	
21		1.075	.780		.865	.985	.421			1.059	—	.268	
25		1.175	.880		.965	1.031	—			1.159	—	.333	
31		1.325	1.030		1.115	1.046	.400			1.309	.240	.354	
37		1.475	1.180		1.265	1.081	—			1.459	—	.404	
51	3	1.825	1.530	.380	1.615	1.193	—	.341	.229	1.809	—	.559	#2-56 UNC THD (.092 DIA THRU)
51		1.425	1.130		1.215	1.233	.625			1.409	.280	.492	
69		1.725	1.430		1.515	1.378	.527			1.703	—	.642	
100	4	2.160	1.522	.430	1.800	1.403	.532	.384	—	1.973	.330	.711	#4-40 UNC THD (.147 DIA THRU)

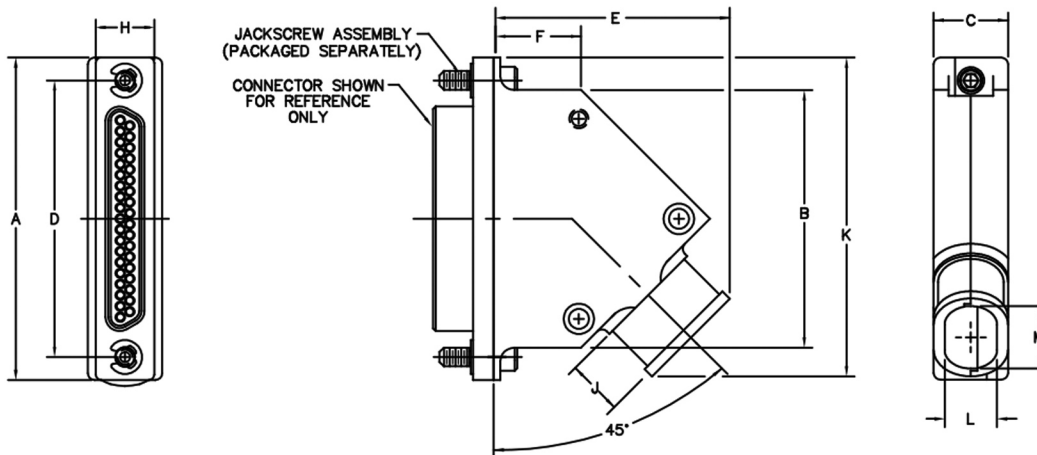



RUGGED: MM-242-031-000-4100  
 XX-XXX-XXX-XXX-XXXX-XXX

<b>SERIES</b>	
MM	.050" Rugged Metal Backshell
<b>BODY</b>	
2	2-Row (Sizes 9 thru 51)
3	3-Row (Sizes 51 & 69)
4	4-Row (Size 100)
BODY STYLE:	
4	45°, one piece
6	45°, two piece **
BODY MATERIAL:	
2	Aluminum, with electroless nickel plating
3	Aluminum, with electrodeposited cadmium ☒
4	Aluminum, with hard anodized black plating
<b>SIZE</b>	
XXX	009, 015, 021, 025, 031, 037, 051, 069, 100
<b>CONTACTS</b>	
TYPE CONTACTS/TERMINATIONS:	
000	None
<b>HARDWARE</b>	
STYLE OF HARDWARE:	
00	None
22	Two fixed jacknut assemblies (62*)
41	Two turning jackscrews, allen head, retaining ring (81*)
43	Two turning jackscrews, slot head, retaining ring (83*)
POLARIZATION / WIRING:	
00	None
<b>OPTIONS</b>	
0FZ	Required for receptacles with grounding fingers when ordering hardware styles 41, 43, 81, & 83

\* = Use number in parenthesis when ordering size 100.  
 \*\* = Sizes 9 and 15 not recommended for solder cup applications.

Stainless steel micro band for shield termination - AirBorn part number CDG10026  
 Band-it application tool - AirBorn part number CDG10027

☒ = Option not RoHS compliant

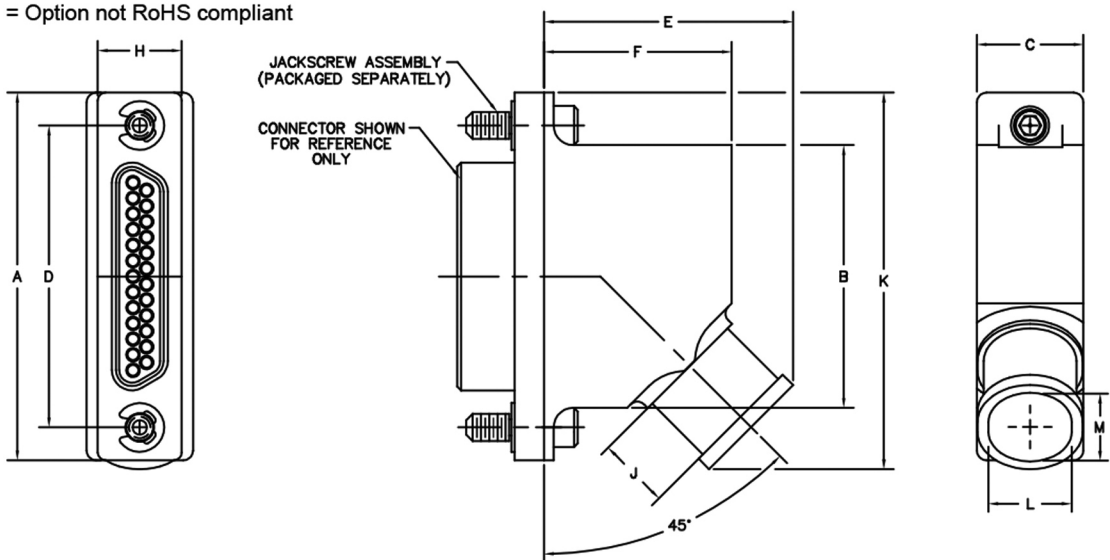



# EMI/RFI 90° Backshells

**.050"**  
**9 thru 100 Contacts**

**Rugged Metal**

**MM**

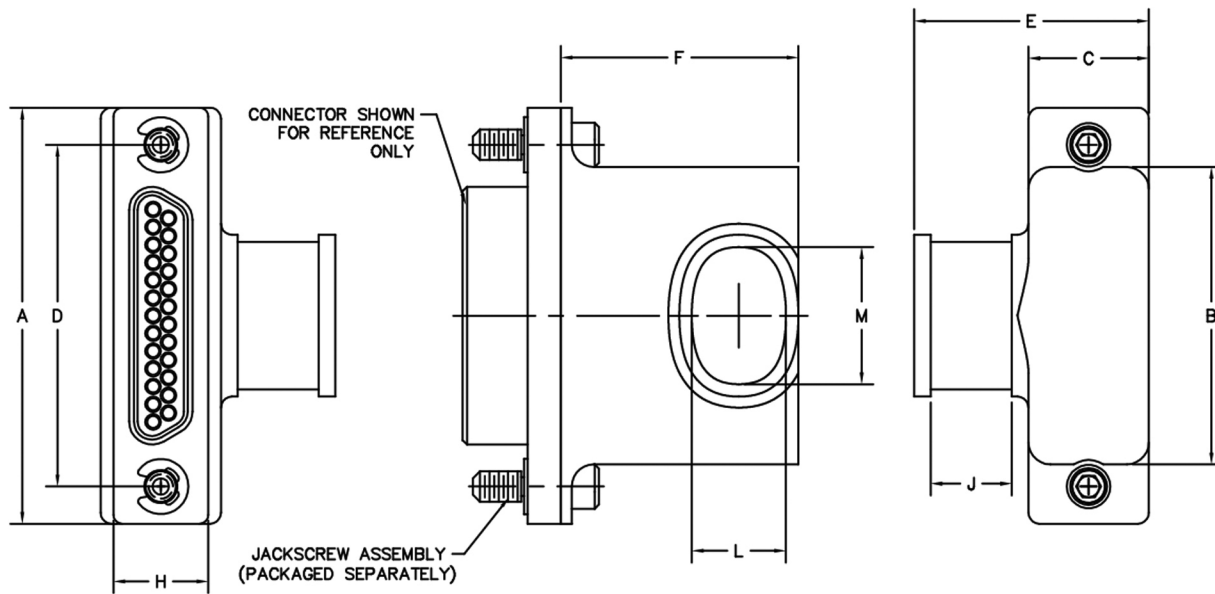
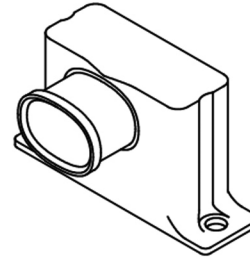

ONE PIECE

DIMENSIONS												
SIZE	CONTACT ROWS	A	B	C	D	E	F	H	J	L	M	HARDWARE
9	2	.775	.440	.340	.565	.663	.671	.298	.229	.266	.268	#2-56 UNC THD (.092 DIA THRU)
15		.925	.590		.715						.311	
21		1.075	.740		.865						.331	
25		1.175	.840		.965						.387	
31		1.325	.990		1.115						.450	
37		1.475	1.140		1.265						.511	
51		1.825	1.490		1.615						.678	
51	3	1.425	1.090	.380	1.215	.703	.703	.341	.298	.619	.823	
69		1.725	1.390		1.515							
100	4	2.160	1.522	.430	1.800	.753	.749	.384	.344	1.063	1.063	#4-40 UNC THD (.147 DIA THRU)



RUGGED: MM-272-031-000-4100  
 XX-XXX-XXX-XXX-XXXX

<b>SERIES</b>	
MM	.050" Rugged Metal Backshell
<b>BODY</b>	
2	2-Row (Sizes 9 thru 51)
3	3-Row (Sizes 51 & 69)
4	4-Row (Size 100)
BODY STYLE:	
7	90°, one piece
BODY MATERIAL:	
2	Aluminum, with electroless nickel plating
3	Aluminum, with electrodeposited cadmium <input checked="" type="checkbox"/>
4	Aluminum, with hard anodized black plating
<b>SIZE</b>	
XXX	009, 015, 021, 025, 031, 037, 051, 069, 100
<b>EXIT</b>	
000	Standard exit**
<b>HARDWARE</b>	
STYLE OF HARDWARE:	
00	None
22	Two fixed jacknut assemblies (62*)
41	Two turning jackscrews, allen head, retaining ring (81*)
43	Two turning jackscrews, slot head, retaining ring (83*)
44	Two long turning jackscrews, slot head, retaining ring (84*)
POLARIZATION / WIRING:	
00	None

\* = Use number in parenthesis when ordering size 100.  
 \*\* = Backshell exits are designed to accomodate 26AWG wire or smaller

Stainless steel micro band for shield termination - AirBorn part number CDG10026, shipped with each backshell  
 Band-it application tool - AirBorn part number CDG10027

= Option not ROHS compliant



# EMI/RFI Straight Backshells

**.050"**

**9 thru 51 Contacts**

**Low Profile Metal**

**MQ**

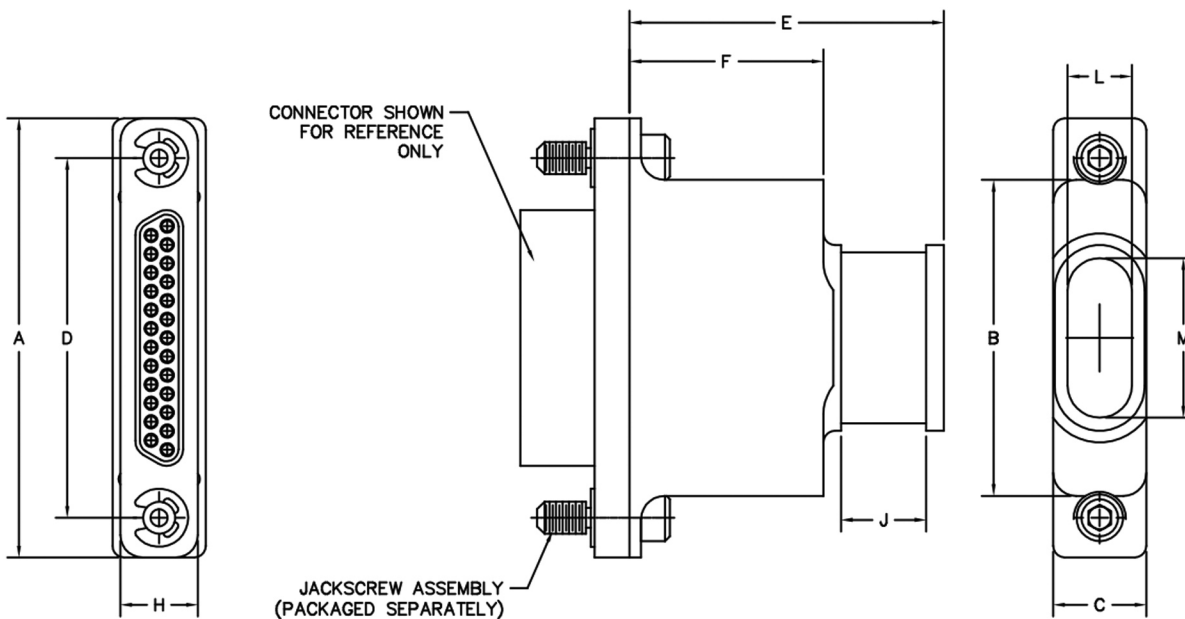
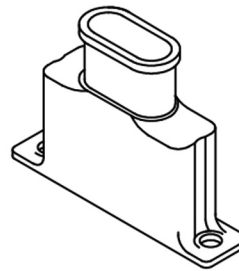

ONE PIECE

		DIMENSIONS										
SIZE	CONTACT ROWS	A	B	C	D	E	F	H	J	L	M	HARDWARE
9	2	.778	.448	.250	.565	.843	.520	.208	.229	.172	.197	#2-56 UNC THD (.092 DIA THRU)
15		.928	.598		.715						.279	
21		1.078	.748		.865						.339	
25		1.178	.848		.965						.428	
31		1.328	.998		1.115						.462	
37	1.478	1.148	1.265	.531								
51	3	1.428	1.098	.292	1.215	.933	.610	.250		.220	.596	

RUGGED: MQ-232-025-000-4100  
 XX-XXX-XXX-XXX-XXXX

<b>SERIES</b>	
MQ	.050" Low Profile Metal Backshell
<b>BODY</b>	
2	2-Row (Sizes 9 thru 37)
3	3-Row (Sizes 51)
<b>BODY STYLE:</b>	
3	Straight, one piece
<b>BODY MATERIAL:</b>	
2	Aluminum, with electroless nickel plating
3	Aluminum, with electrodeposited cadmium <input checked="" type="checkbox"/>
4	Aluminum, with hard anodized black plating
<b>SIZE</b>	
XXX	009, 015, 021, 025, 031, 037, 051
<b>EXIT</b>	
000	Standard exit
<b>HARDWARE</b>	
<b>STYLE OF HARDWARE:</b>	
00	None
22	Two fixed jacknut assemblies
41	Two turning jackscrews, allen head, retaining ring
43	Two turning jackscrews, slot head, retaining ring
44	Two long turning jackscrews, slot head, retaining ring
<b>POLARIZATION / WIRING:</b>	
00	None

Stainless steel micro band for shield termination - AirBorn part number CDG10026, shipped with each backshell  
 Band-it application tool - AirBorn part number CDG10027

= Option not ROHS compliant



## Dust Covers

**.050"**  
**9 thru 100 Contacts**

**Rugged Metal**

**MD**

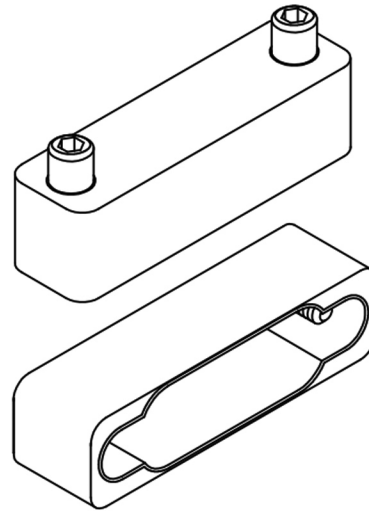

MD021RSM245

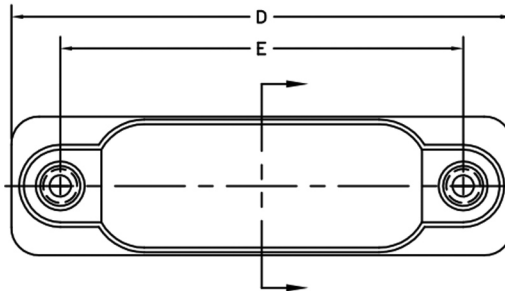
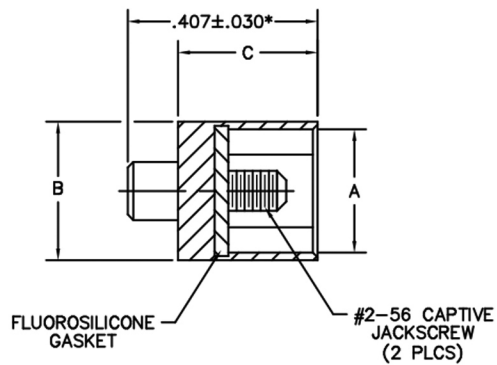

DIMENSIONS								
SIZE	A		B		C	D	E	HARDWARE
	PLUG	RCPT	PLUG	RCPT				
9					.299	.775	.565	#2-56 UNC THD
15						.925	.715	
21						1.075	.865	
25	.203	.265	.298	.298		1.175	.965	
31						1.325	1.115	
37						1.475	1.265	
51	.246	.308	.341	.341		1.425	1.215	
69					1.725	1.515		
100	.291	.394	.381	.434	2.152	<b>1.800</b>	#4-40 UNC THD	

\* = 100 POS DIMENSION .460±.030



PLUG		RECEPTACLE		RECEPTACLE: MD 021 RS M2 45 XX XXX XX XX XX				
<b>SERIES</b>		MD .050" Rugged Metal Dust Cover		MD .050" Rugged Metal Dust Cover				
<b>SIZE</b>		XXX 009, 015, 021, 025, 031, 037, 051, 069, 100		XXX 009, 015, 021, 025, 031, 037, 051, 069, 100				
<b>STYLE</b>		RP Plug, rugged metal		RS Receptacle, rugged metal				
<b>PLATING</b>		M2 Electroless nickel M3 Electrodeposited cadmium <input checked="" type="checkbox"/> M4 Hard anodized black		M2 Electroless nickel M3 Electrodeposited cadmium <input checked="" type="checkbox"/> M4 Hard anodized black				
<b>HARDWARE</b>		STYLE OF HARDWARE: 22 Two integrated jacknuts (62*) 45 Two turning jackscrews, allen head, captivated** (85*)		STYLE OF HARDWARE: 22 Two integrated jacknuts (62*) 45 Two turning jackscrews, allen head, captivated** (85*)				

\* = Use number in parenthesis when ordering size 100.  
 \*\* = Captive hardware is factory installed and non-removable.

Not for use with rear panel mount connectors  
 Not for use on receptacles with grounding fingers

= Option not RoHS compliant



# ESD Dust Covers

**.050"**  
9 thru 100 Contacts

**Rugged Metal**  
**Low Profile Plastic**

**MD**

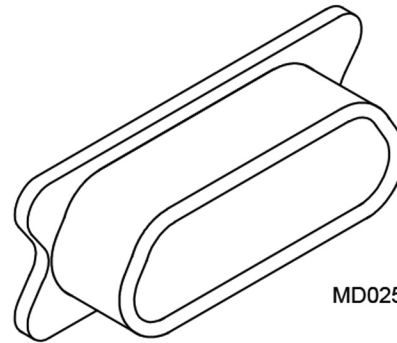
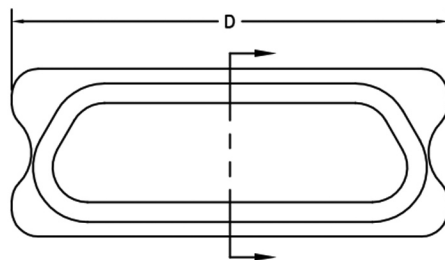
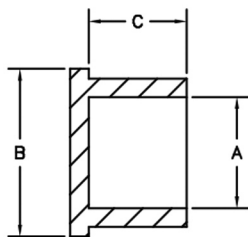

MD025RS

EXAMPLE: MD025RS  
MDXXXXX

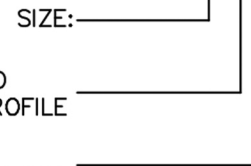

- R – RUGGED
- L – LOW PROFILE
- P – PLUG
- S – RECEPTACLE

Material: Carbon filled polypropylene  
 Static Decay meets MIL-PRF-81705D  
 Surface Resistivity per ASTM D 257-99(2005):  $<1.0 \times 10^{12}$  ohms/square

### RUGGED PLASTIC

SIZE	CONTACT ROWS	DIMENSIONS								PART NUMBER	
		A		B		C		D		PLUG	RCPT
		PLUG	RCPT	PLUG	RCPT	PLUG	RCPT	PLUG	RCPT		
9	2	.176	.238	.298	.360	.195	.215	.475	.460	MD009RP	MD009RS
15								.625	.610	MD015RP	MD015RS
21								.775	.760	MD021RP	MD021RS
25								.875	.860	MD025RP	MD025RS
31								1.025	1.010	MD031RP	MD031RS
37								1.175	1.160	MD037RP	MD037RS
51								1.525	1.510	MD051RP-2	MD051RS-2
51								1.125	1.110	MD051RP	MD051RS
69	3	.219	.281	.340	.400	1.425	1.410	MD069RP	MD069RS		
100	4	.265	.379	.385	.500	1.500	1.615	MD100RP	MD100RS		

### LOW PROFILE PLASTIC

SIZE	CONTACT ROWS	DIMENSIONS								PART NUMBER	
		A		B		C		D		PLUG	RCPT
		PLUG	RCPT	PLUG	RCPT	PLUG	RCPT	PLUG	RCPT		
9	2	.125	.205	.256	.315	.210	.195	.400	.430	MD009LP	MD009LS
15								.550	.580	MD015LP	MD015LS
21								.700	.730	MD021LP	MD021LS
25								.800	.830	MD025LP	MD025LS
31								.950	.980	MD031LP	MD031LS
37								1.100	1.130	MD037LP	MD037LS
51	3	.168	.247	.298	.360	1.050	1.080	MD051LP	MD051LS		

Not for use on receptacles with grounding fingers



## O-Rings, Fluorosilicone & Butyl

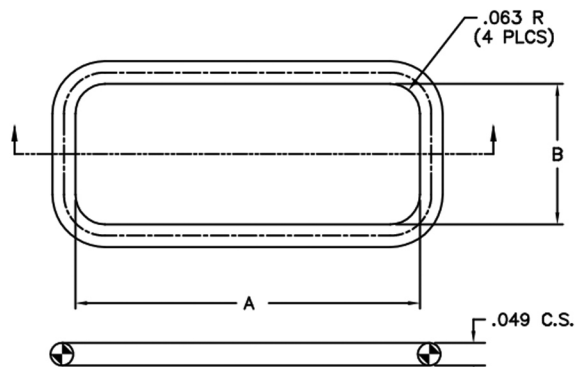

DIMENSIONS (Ref Only)			
SIZE	CONTACT ROWS	A	B
9	2	.739	.301
15		.889	
21		1.039	
25		1.139	
31		1.297	
37		1.439	
51	3	1.439	.344
69		1.731	
100	4	2.159	.421

FLUOROSILICONE	
SIZE	P/N
9	CDG17148
15	CDG17149
21	CDG17150
25	CDG17151
31	CDG17152
37	CDG17153
51	CDG17154
69	CDG17155
100	CDG17156

BUTYL	
SIZE	P/N
9	CDG17478
15	CDG17479
21	CDG17480
25	CDG17481
31	CDG17482
37	CDG17483
51	CDG17484
69	CDG17485
100	CDG17486

## EMI Gasket, Fluorosilicone

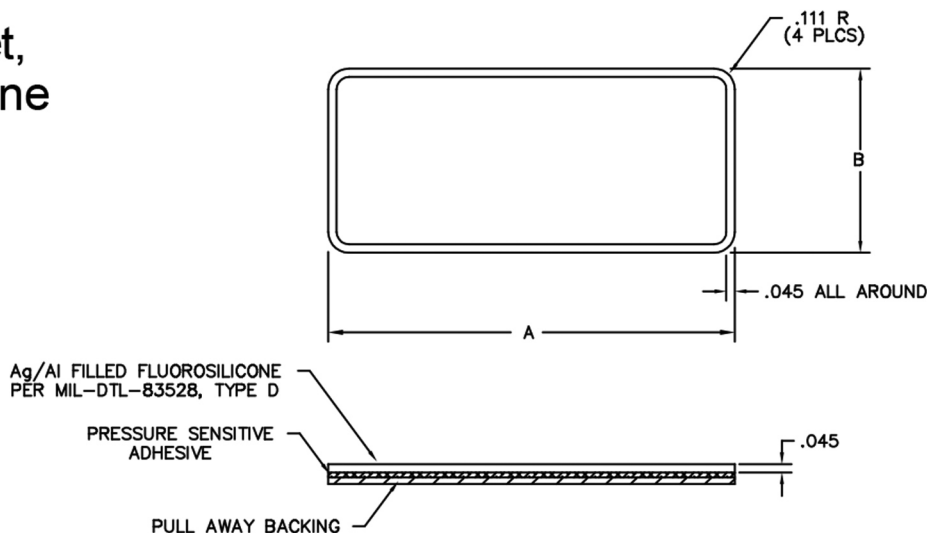

DIMENSIONS (Ref Only)			
SIZE	CONTACT ROWS	A	B
9	2	.872	.395
15		1.022	
21		1.172	
25		1.272	
31		1.422	
37		1.572	
51	3	1.572	.438
69		1.872	
100	4	2.298	.515

PART NUMBERS	
SIZE	P/N
9	CDG15933
15	CDG15934
21	CDG15935
25	CDG15936
31	CDG15937
37	CDG13044
51	CDG15938
69	CDG12978
100	CDG15939



## Hardware

### MM - MN - MQ - MP Rear Panel Mount Hardware for Standard I/O Connectors

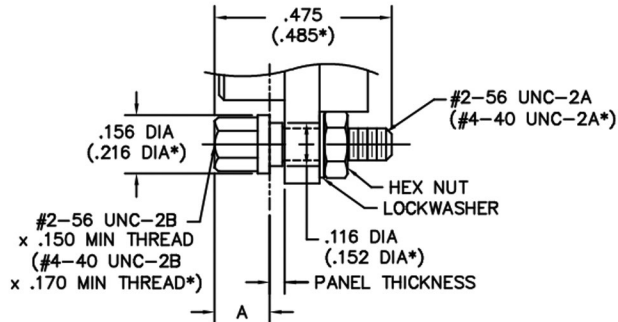

PANEL THK	THREAD SIZE	PART NUMBER	A MAX
.040	#2-56	MM-000-000-000-2400-0F4	.150
.050		MM-000-000-000-2500-0F5	.140
.060		MM-000-000-000-2600-0F6	.130
.070		MM-000-000-000-2800-0F7	.120
.080		MM-000-000-000-2900-0F8	.110
.040	#4-40	MM-000-000-000-6400-0F9	.150
.050		MM-000-000-000-6500-0FA	.140
.060		MM-000-000-000-6600-0FB	.130
.070		MM-000-000-000-6800-0FC	.120
.080		MM-000-000-000-6900-0FD	.110

\* = Dimensions for 100 position connectors

### MM - MN - MQ - MP Rear Panel Mount Hardware for I/O Connectors with Grounding Fingers, Integrated Shield Termination, or I/O with EMI/RFI Backshell

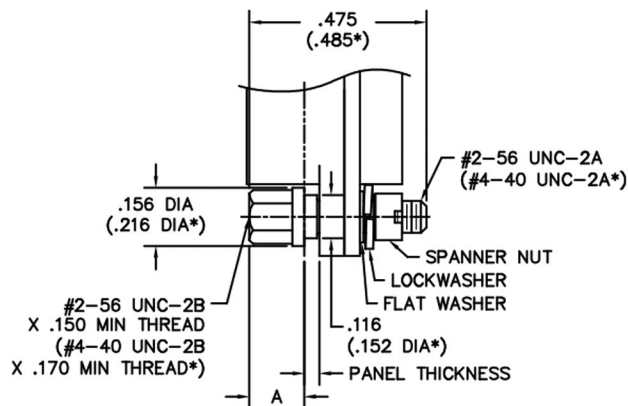

PANEL THK	THREAD SIZE	PART NUMBER	A MAX
.040	#2-56	MM-000-000-000-2400-0G7	.150
.050		MM-000-000-000-2500-0G7	.140
.060		MM-000-000-000-2600-0G7	.130
.070		MM-000-000-000-2800-0G7	.120
.080		MM-000-000-000-2900-0G7	.110
.040	#4-40	MM-000-000-000-6400-0G7	.150
.050		MM-000-000-000-6500-0G7	.140
.060		MM-000-000-000-6600-0G7	.130
.070		MM-000-000-000-6800-0G7	.120
.080		MM-000-000-000-6900-0G7	.110

\* = Dimensions for 100 position connectors

## Panel Mounting Dimensions for Receptacles With Grounding Fingers

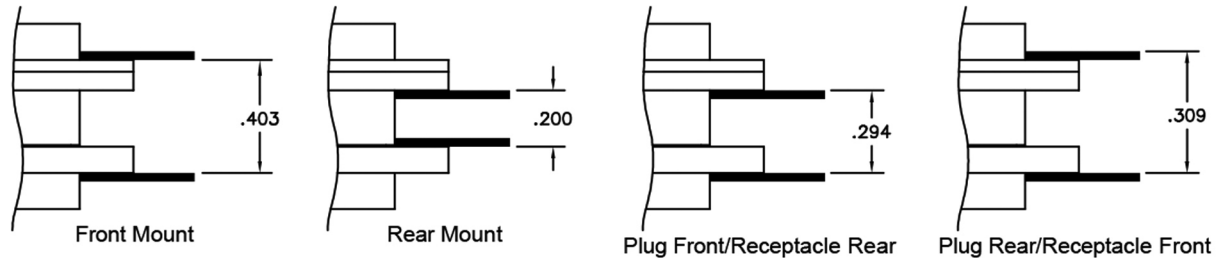

## Front Panel Mounting Receptacles With Grounding Fingers

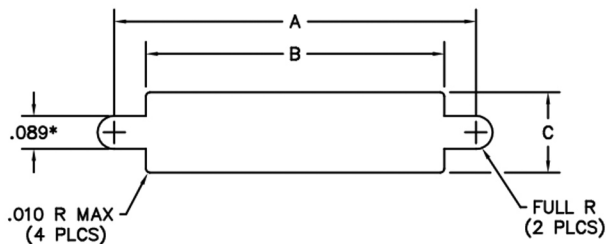

\* = .118 FOR 100 POSITION CONNECTOR

SIZE	DIMENSIONS			
	A +.004 -.000	B +.005 -.000	C +.004 -.000	
			MP, MQ, MR, MS MQHT, MSHT	MK, ML, MM, MN MKHT, MMHT
9	.570	.400	.215	.273
15	.720	.550		
21	.870	.700		
25	.970	.800		
31	1.120	.950		
37	1.270	1.100	.256	.311
51	1.220	1.050		
69	1.520	1.350		
100	1.805	1.442	—	.383

## Rear Panel Mounting Receptacles With Grounding Fingers

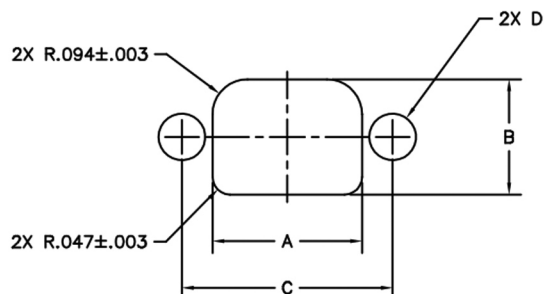

SIZE	DIMENSIONS			
	A +.004 -.000	B +.004 -.000	C ±.005	D ±.005 THRU
9	.401	.308	.565	.125
15	.551		.715	
21	.701		.865	
25	.801		.965	
31	.951		1.115	
37	1.101	.351	1.265	.160
51	1.051		1.215	
69	1.351		1.515	
100	1.505	.391	1.800	



## C-Clip Hardware

### MM - MN - MQ - MP - MMHT - MQHT Jacking Hardware

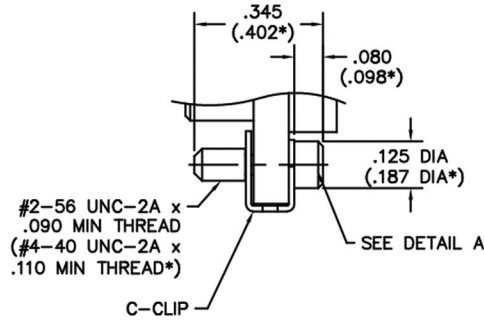

SHORT TURNING  
JACKSCREW ASSEMBLY  
C-CLIP RETAINER

#2-56 JACKSCREW, ALLEN HEAD 00-000-000-000-4A00  
#4-40 JACKSCREW, ALLEN HEAD 00-000-000-000-8A00

### MM - MQ I/O with EMI/RFI Backshell

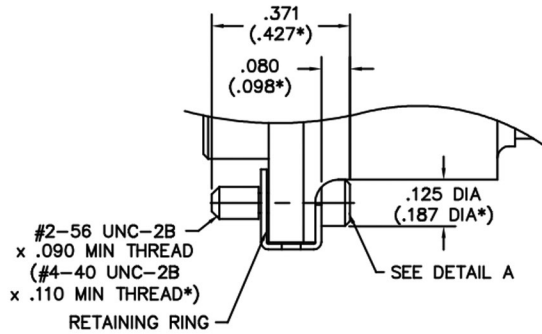

SHORT TURNING  
JACKSCREW ASSEMBLY  
C-CLIP RETAINER

#2-56 JACKSCREW, ALLEN HEAD 00-000-000-000-4A00-01G  
#4-40 JACKSCREW, ALLEN HEAD 00-000-000-000-8A00-04A

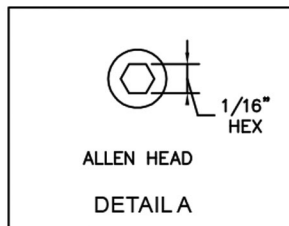

\* = Dimensions for #4-40 hardware (100 position connectors)

# MILITARY CROSS REFERENCE



## Military Cross Reference Chart

### M83513 / 01

M83513 / 01 - AC	MM-213-009-113-0000	M83513 / 01 - DC	MM-213-025-113-0000	M83513 / 01 - GC	MM-313-051-113-0000
M83513 / 01 - AN	MM-212-009-113-0000	M83513 / 01 - DN	MM-212-025-113-0000	M83513 / 01 - GN	MM-312-051-113-0000
M83513 / 01 - AP	MM-215-009-113-0000	M83513 / 01 - DP	MM-215-025-113-0000	M83513 / 01 - GP	MM-315-051-113-0000
M83513 / 01 - BC	MM-213-015-113-0000	M83513 / 01 - EC	MM-213-031-113-0000	M83513 / 01 - HC	MM-413-100-113-0000
M83513 / 01 - BN	MM-212-015-113-0000	M83513 / 01 - EN	MM-212-031-113-0000	M83513 / 01 - HN	MM-412-100-113-0000
M83513 / 01 - BP	MM-215-015-113-0000	M83513 / 01 - EP	MM-215-031-113-0000	M83513 / 01 - HP	MM-415-100-113-0000
M83513 / 01 - CC	MM-213-021-113-0000	M83513 / 01 - FC	MM-213-037-113-0000		
M83513 / 01 - CN	MM-212-021-113-0000	M83513 / 01 - FN	MM-212-037-113-0000		
M83513 / 01 - CP	MM-215-021-113-0000	M83513 / 01 - FP	MM-215-037-113-0000		

### M83513 / 02

M83513 / 02 - AC	MM-223-009-213-0000-900	M83513 / 02 - DC	MM-223-025-213-0000-900	M83513 / 02 - GC	MM-323-051-213-0000-900
M83513 / 02 - AN	MM-222-009-213-0000-900	M83513 / 02 - DN	MM-222-025-213-0000-900	M83513 / 02 - GN	MM-322-051-213-0000-900
M83513 / 02 - AP	MM-225-009-213-0000-900	M83513 / 02 - DP	MM-225-025-213-0000-900	M83513 / 02 - GP	MM-325-051-213-0000-900
M83513 / 02 - BC	MM-223-015-213-0000-900	M83513 / 02 - EC	MM-223-031-213-0000-900	M83513 / 02 - HC	MM-423-100-213-0000-900
M83513 / 02 - BN	MM-222-015-213-0000-900	M83513 / 02 - EN	MM-222-031-213-0000-900	M83513 / 02 - HN	MM-422-100-213-0000-900
M83513 / 02 - BP	MM-225-015-213-0000-900	M83513 / 02 - EP	MM-225-031-213-0000-900	M83513 / 02 - HP	MM-425-100-213-0000-900
M83513 / 02 - CC	MM-223-021-213-0000-900	M83513 / 02 - FC	MM-223-037-213-0000-900		
M83513 / 02 - CN	MM-222-021-213-0000-900	M83513 / 02 - FN	MM-222-037-213-0000-900		
M83513 / 02 - CP	MM-225-021-213-0000-900	M83513 / 02 - FP	MM-225-037-213-0000-900		

### M83513 / 03

M83513 / 03-A01C	MM-213-009-161-00W1	M83513 / 03-A12C	MM-213-009-161-00Y4	M83513 / 03-B06P	MM-215-015-153-0000
M83513 / 03-A01N	MM-212-009-161-00W1	M83513 / 03-A12N	MM-212-009-161-00Y4	M83513 / 03-B07C	MM-213-015-145-0000
M83513 / 03-A01P	MM-215-009-161-00W1	M83513 / 03-A12P	MM-215-009-161-00Y4	M83513 / 03-B07N	MM-212-015-145-0000
M83513 / 03-A02C	MM-213-009-161-00W2	M83513 / 03-A13C	MM-213-009-161-00Y5	M83513 / 03-B07P	MM-215-015-145-0000
M83513 / 03-A02N	MM-212-009-161-00W2	M83513 / 03-A13N	MM-212-009-161-00Y5	M83513 / 03-B08C	MM-213-015-155-0000
M83513 / 03-A02P	MM-215-009-161-00W2	M83513 / 03-A13P	MM-215-009-161-00Y5	M83513 / 03-B08N	MM-212-015-155-0000
M83513 / 03-A03C	MM-213-009-161-00V1	M83513 / 03-A14C	MM-213-009-161-00Y6	M83513 / 03-B08P	MM-215-015-155-0000
M83513 / 03-A03N	MM-212-009-161-00V1	M83513 / 03-A14N	MM-212-009-161-00Y6	M83513 / 03-B09C	MM-213-015-161-00Y1
M83513 / 03-A03P	MM-215-009-161-00V1	M83513 / 03-A14P	MM-215-009-161-00Y6	M83513 / 03-B09N	MM-212-015-161-00Y1
M83513 / 03-A04C	MM-213-009-161-00V2	M83513 / 03-A15C	MM-213-009-161-00Y7	M83513 / 03-B09P	MM-215-015-161-00Y1
M83513 / 03-A04N	MM-212-009-161-00V2	M83513 / 03-A15N	MM-212-009-161-00Y7	M83513 / 03-B10C	MM-213-015-161-00Y2
M83513 / 03-A04P	MM-215-009-161-00V2	M83513 / 03-A15P	MM-215-009-161-00Y7	M83513 / 03-B10N	MM-212-015-161-00Y2
M83513 / 03-A05C	MM-213-009-143-0000	M83513 / 03-A16C	MM-213-009-161-00Y8	M83513 / 03-B10P	MM-215-015-161-00Y2
M83513 / 03-A05N	MM-212-009-143-0000	M83513 / 03-A16N	MM-212-009-161-00Y8	M83513 / 03-B11C	MM-213-015-161-00Y3
M83513 / 03-A05P	MM-215-009-143-0000	M83513 / 03-A16P	MM-215-009-161-00Y8	M83513 / 03-B11N	MM-212-015-161-00Y3
M83513 / 03-A06C	MM-213-009-153-0000			M83513 / 03-B11P	MM-215-015-161-00Y3
M83513 / 03-A06N	MM-212-009-153-0000	M83513 / 03-B01C	MM-213-015-161-00W1	M83513 / 03-B12C	MM-213-015-161-00Y4
M83513 / 03-A06P	MM-215-009-153-0000	M83513 / 03-B01N	MM-212-015-161-00W1	M83513 / 03-B12N	MM-212-015-161-00Y4
M83513 / 03-A07C	MM-213-009-145-0000	M83513 / 03-B01P	MM-215-015-161-00W1	M83513 / 03-B12P	MM-215-015-161-00Y4
M83513 / 03-A07N	MM-212-009-145-0000	M83513 / 03-B02C	MM-213-015-161-00W2	M83513 / 03-B13C	MM-213-015-161-00Y5
M83513 / 03-A07P	MM-215-009-145-0000	M83513 / 03-B02N	MM-212-015-161-00W2	M83513 / 03-B13N	MM-212-015-161-00Y5
M83513 / 03-A08C	MM-213-009-155-0000	M83513 / 03-B02P	MM-215-015-161-00W2	M83513 / 03-B13P	MM-215-015-161-00Y5
M83513 / 03-A08N	MM-212-009-155-0000	M83513 / 03-B03C	MM-213-015-161-00V1	M83513 / 03-B14C	MM-213-015-161-00Y6
M83513 / 03-A08P	MM-215-009-155-0000	M83513 / 03-B03N	MM-212-015-161-00V1	M83513 / 03-B14N	MM-212-015-161-00Y6
M83513 / 03-A09C	MM-213-009-161-00Y1	M83513 / 03-B03P	MM-215-015-161-00V1	M83513 / 03-B14P	MM-215-015-161-00Y6
M83513 / 03-A09N	MM-212-009-161-00Y1	M83513 / 03-B04C	MM-213-015-161-00V2	M83513 / 03-B15C	MM-213-015-161-00Y7
M83513 / 03-A09P	MM-215-009-161-00Y1	M83513 / 03-B04N	MM-212-015-161-00V2	M83513 / 03-B15N	MM-212-015-161-00Y7
M83513 / 03-A10C	MM-213-009-161-00Y2	M83513 / 03-B04P	MM-215-015-161-00V2	M83513 / 03-B15P	MM-215-015-161-00Y7
M83513 / 03-A10N	MM-212-009-161-00Y2	M83513 / 03-B05C	MM-213-015-143-0000	M83513 / 03-B16C	MM-213-015-161-00Y8
M83513 / 03-A10P	MM-215-009-161-00Y2	M83513 / 03-B05N	MM-212-015-143-0000	M83513 / 03-B16N	MM-212-015-161-00Y8
M83513 / 03-A11C	MM-213-009-161-00Y3	M83513 / 03-B05P	MM-215-015-143-0000	M83513 / 03-B16P	MM-215-015-161-00Y8
M83513 / 03-A11N	MM-212-009-161-00Y3	M83513 / 03-B06C	MM-213-015-153-0000		
M83513 / 03-A11P	MM-215-009-161-00Y3	M83513 / 03-B06N	MM-212-015-153-0000		

## Military Cross Reference Chart

– Continued from previous page

### M83513 / 03 (continued)

M83513 / 03-C01C	MM-213-021-161-00W1	M83513 / 03-D03N	MM-212-025-161-00V1	M83513 / 03-E05P	MM-215-031-143-0000
M83513 / 03-C01N	MM-212-021-161-00W1	M83513 / 03-D03P	MM-215-025-161-00V1	M83513 / 03-E06C	MM-213-031-153-0000
M83513 / 03-C01P	MM-215-021-161-00W1	M83513 / 03-D04C	MM-213-025-161-00V2	M83513 / 03-E06N	MM-212-031-153-0000
M83513 / 03-C02C	MM-213-021-161-00W2	M83513 / 03-D04N	MM-212-025-161-00V2	M83513 / 03-E06P	MM-215-031-153-0000
M83513 / 03-C02N	MM-212-021-161-00W2	M83513 / 03-D04P	MM-215-025-161-00V2	M83513 / 03-E07C	MM-213-031-145-0000
M83513 / 03-C02P	MM-215-021-161-00W2	M83513 / 03-D05C	MM-213-025-143-0000	M83513 / 03-E07N	MM-212-031-145-0000
M83513 / 03-C03C	MM-213-021-161-00V1	M83513 / 03-D05N	MM-212-025-143-0000	M83513 / 03-E07P	MM-215-031-145-0000
M83513 / 03-C03N	MM-212-021-161-00V1	M83513 / 03-D05P	MM-215-025-143-0000	M83513 / 03-E08C	MM-213-031-155-0000
M83513 / 03-C03P	MM-215-021-161-00V1	M83513 / 03-D06C	MM-213-025-153-0000	M83513 / 03-E08N	MM-212-031-155-0000
M83513 / 03-C04C	MM-213-021-161-00V2	M83513 / 03-D06N	MM-212-025-153-0000	M83513 / 03-E08P	MM-215-031-155-0000
M83513 / 03-C04N	MM-212-021-161-00V2	M83513 / 03-D06P	MM-215-025-153-0000	M83513 / 03-E09C	MM-213-031-161-00Y1
M83513 / 03-C04P	MM-215-021-161-00V2	M83513 / 03-D07C	MM-213-025-145-0000	M83513 / 03-E09N	MM-212-031-161-00Y1
M83513 / 03-C05C	MM-213-021-143-0000	M83513 / 03-D07N	MM-212-025-145-0000	M83513 / 03-E09P	MM-215-031-161-00Y1
M83513 / 03-C05N	MM-212-021-143-0000	M83513 / 03-D07P	MM-215-025-145-0000	M83513 / 03-E10C	MM-213-031-161-00Y2
M83513 / 03-C05P	MM-215-021-143-0000	M83513 / 03-D08C	MM-213-025-155-0000	M83513 / 03-E10N	MM-212-031-161-00Y2
M83513 / 03-C06C	MM-213-021-153-0000	M83513 / 03-D08N	MM-212-025-155-0000	M83513 / 03-E10P	MM-215-031-161-00Y2
M83513 / 03-C06N	MM-212-021-153-0000	M83513 / 03-D08P	MM-215-025-155-0000	M83513 / 03-E11C	MM-213-031-161-00Y3
M83513 / 03-C06P	MM-215-021-153-0000	M83513 / 03-D09C	MM-213-025-161-00Y1	M83513 / 03-E11N	MM-212-031-161-00Y3
M83513 / 03-C07C	MM-213-021-145-0000	M83513 / 03-D09N	MM-212-025-161-00Y1	M83513 / 03-E11P	MM-215-031-161-00Y3
M83513 / 03-C07N	MM-212-021-145-0000	M83513 / 03-D09P	MM-215-025-161-00Y1	M83513 / 03-E12C	MM-213-031-161-00Y4
M83513 / 03-C07P	MM-215-021-145-0000	M83513 / 03-D10C	MM-213-025-161-00Y2	M83513 / 03-E12N	MM-212-031-161-00Y4
M83513 / 03-C08C	MM-213-021-155-0000	M83513 / 03-D10N	MM-212-025-161-00Y2	M83513 / 03-E12P	MM-215-031-161-00Y4
M83513 / 03-C08N	MM-212-021-155-0000	M83513 / 03-D10P	MM-215-025-161-00Y2	M83513 / 03-E13C	MM-213-031-161-00Y5
M83513 / 03-C08P	MM-215-021-155-0000	M83513 / 03-D11C	MM-212-025-161-00Y3	M83513 / 03-E13N	MM-212-031-161-00Y5
M83513 / 03-C09C	MM-213-021-161-00Y1	M83513 / 03-D11N	MM-212-025-161-00Y3	M83513 / 03-E13P	MM-215-031-161-00Y5
M83513 / 03-C09N	MM-212-021-161-00Y1	M83513 / 03-D11P	MM-215-025-161-00Y3	M83513 / 03-E14C	MM-213-031-161-00Y6
M83513 / 03-C09P	MM-215-021-161-00Y1	M83513 / 03-D12C	MM-213-025-161-00Y4	M83513 / 03-E14N	MM-212-031-161-00Y6
M83513 / 03-C10C	MM-213-021-161-00Y2	M83513 / 03-D12N	MM-212-025-161-00Y4	M83513 / 03-E14P	MM-215-031-161-00Y6
M83513 / 03-C10N	MM-212-021-161-00Y2	M83513 / 03-D12P	MM-215-025-161-00Y4	M83513 / 03-E15C	MM-213-031-161-00Y7
M83513 / 03-C10P	MM-215-021-161-00Y2	M83513 / 03-D13C	MM-213-025-161-00Y5	M83513 / 03-E15N	MM-212-031-161-00Y7
M83513 / 03-C11C	MM-213-021-161-00Y3	M83513 / 03-D13N	MM-212-025-161-00Y5	M83513 / 03-E15P	MM-212-031-161-00Y7
M83513 / 03-C11N	MM-212-021-161-00Y3	M83513 / 03-D13P	MM-215-025-161-00Y5	M83513 / 03-E16C	MM-213-031-161-00Y8
M83513 / 03-C11P	MM-215-021-161-00Y3	M83513 / 03-D14C	MM-213-025-161-00Y6	M83513 / 03-E16N	MM-212-031-161-00Y8
M83513 / 03-C12C	MM-213-021-161-00Y4	M83513 / 03-D14N	MM-212-025-161-00Y6	M83513 / 03-E16P	MM-215-031-161-00Y8
M83513 / 03-C12N	MM-212-021-161-00Y4	M83513 / 03-D14P	MM-215-025-161-00Y6		
M83513 / 03-C12P	MM-215-021-161-00Y4	M83513 / 03-D15C	MM-213-025-161-00Y7	M83513 / 03-F01C	MM-213-037-161-00W1
M83513 / 03-C13C	MM-213-021-161-00Y5	M83513 / 03-D15N	MM-212-025-161-00Y7	M83513 / 03-F01N	MM-212-037-161-00W1
M83513 / 03-C13N	MM-212-021-161-00Y5	M83513 / 03-D15P	MM-215-025-161-00Y7	M83513 / 03-F01P	MM-215-037-161-00W1
M83513 / 03-C13P	MM-215-021-161-00Y5	M83513 / 03-D16C	MM-213-025-161-00Y8	M83513 / 03-F02C	MM-213-037-161-00W2
M83513 / 03-C14C	MM-213-021-161-00Y6	M83513 / 03-D16N	MM-212-025-161-00Y8	M83513 / 03-F02N	MM-212-037-161-00W2
M83513 / 03-C14N	MM-212-021-161-00Y6	M83513 / 03-D16P	MM-215-025-161-00Y8	M83513 / 03-F02P	MM-215-037-161-00W2
M83513 / 03-C14P	MM-215-021-161-00Y6			M83513 / 03-F03C	MM-213-037-161-00V1
M83513 / 03-C15C	MM-213-021-161-00Y7	M83513 / 03-E01C	MM-213-031-161-00W1	M83513 / 03-F03N	MM-212-037-161-00V1
M83513 / 03-C15N	MM-212-021-161-00Y7	M83513 / 03-E01N	MM-212-031-161-00W1	M83513 / 03-F03P	MM-215-037-161-00V1
M83513 / 03-C15P	MM-215-021-161-00Y7	M83513 / 03-E01P	MM-215-031-161-00W1	M83513 / 03-F04C	MM-213-037-161-00V2
M83513 / 03-C16C	MM-213-021-161-00Y8	M83513 / 03-E02C	MM-213-031-161-00W2	M83513 / 03-F04N	MM-212-037-161-00V2
M83513 / 03-C16N	MM-212-021-161-00Y8	M83513 / 03-E02N	MM-212-031-161-00W2	M83513 / 03-F04P	MM-215-037-161-00V2
M83513 / 03-C16P	MM-215-021-161-00Y8	M83513 / 03-E02P	MM-215-031-161-00W2	M83513 / 03-F05C	MM-213-037-143-0000
		M83513 / 03-E03C	MM-213-031-161-00V1	M83513 / 03-F05N	MM-212-037-143-0000
M83513 / 03-D01C	MM-213-025-161-00W1	M83513 / 03-E03N	MM-212-031-161-00V1	M83513 / 03-F05P	MM-215-037-143-0000
M83513 / 03-D01N	MM-212-025-161-00W1	M83513 / 03-E03P	MM-215-031-161-00V1	M83513 / 03-F06C	MM-213-037-153-0000
M83513 / 03-D01P	MM-215-025-161-00W1	M83513 / 03-E04C	MM-213-031-161-00V2	M83513 / 03-F06N	MM-212-037-153-0000
M83513 / 03-D02C	MM-213-025-161-00W2	M83513 / 03-E04N	MM-212-031-161-00V2	M83513 / 03-F06P	MM-215-037-153-0000
M83513 / 03-D02N	MM-212-025-161-00W2	M83513 / 03-E04P	MM-215-031-161-00V2	M83513 / 03-F07C	MM-213-037-145-0000
M83513 / 03-D02P	MM-215-025-161-00W2	M83513 / 03-E05C	MM-213-031-143-0000	M83513 / 03-F07N	MM-212-037-145-0000
M83513 / 03-D03C	MM-213-025-161-00V1	M83513 / 03-E05N	MM-212-031-143-0000	M83513 / 03-F07P	MM-215-037-145-0000



# Military Cross Reference Chart

-- Continued from previous page

## M83513 / 03 (continued)

M83513 / 03-F08C	MM-213-037-155-0000	M83513 / 03-G05P	MM-315-051-143-0000	M83513 / 03-H03N	MM-412-100-161-00V1
M83513 / 03-F08N	MM-212-037-155-0000	M83513 / 03-G06C	MM-313-051-153-0000	M83513 / 03-H03P	MM-415-100-161-00V1
M83513 / 03-F08P	MM-215-037-155-0000	M83513 / 03-G06N	MM-312-051-153-0000	M83513 / 03-H04C	MM-413-100-161-00V2
M83513 / 03-F09C	MM-213-037-161-00Y1	M83513 / 03-G06P	MM-315-051-153-0000	M83513 / 03-H04N	MM-412-100-161-00V2
M83513 / 03-F09N	MM-212-037-161-00Y1	M83513 / 03-G07C	MM-313-051-145-0000	M83513 / 03-H04P	MM-415-100-161-00V2
M83513 / 03-F09P	MM-215-037-161-00Y1	M83513 / 03-G07N	MM-312-051-145-0000	M83513 / 03-H05C	MM-413-100-143-0000
M83513 / 03-F10C	MM-213-037-161-00Y2	M83513 / 03-G07P	MM-315-051-145-0000	M83513 / 03-H05N	MM-412-100-143-0000
M83513 / 03-F10N	MM-212-037-161-00Y2	M83513 / 03-G08C	MM-313-051-155-0000	M83513 / 03-H05P	MM-415-100-143-0000
M83513 / 03-F10P	MM-215-037-161-00Y2	M83513 / 03-G08N	MM-312-051-155-0000	M83513 / 03-H06C	MM-413-100-153-0000
M83513 / 03-F11C	MM-213-037-161-00Y3	M83513 / 03-G08P	MM-315-051-155-0000	M83513 / 03-H06N	MM-412-100-153-0000
M83513 / 03-F11N	MM-212-037-161-00Y3	M83513 / 03-G09C	MM-313-051-161-00Y1	M83513 / 03-H06P	MM-415-100-153-0000
M83513 / 03-F11P	MM-215-037-161-00Y3	M83513 / 03-G09N	MM-312-051-161-00Y1	M83513 / 03-H07C	MM-413-100-145-0000
M83513 / 03-F12C	MM-213-037-161-00Y4	M83513 / 03-G09P	MM-315-051-161-00Y1	M83513 / 03-H07N	MM-412-100-145-0000
M83513 / 03-F12N	MM-212-037-161-00Y4	M83513 / 03-G10C	MM-313-051-161-00Y2	M83513 / 03-H07P	MM-415-100-145-0000
M83513 / 03-F12P	MM-215-037-161-00Y4	M83513 / 03-G10N	MM-312-051-161-00Y2	M83513 / 03-H08C	MM-413-100-155-0000
M83513 / 03-F13C	MM-213-037-161-00Y5	M83513 / 03-G10P	MM-315-051-161-00Y2	M83513 / 03-H08N	MM-412-100-155-0000
M83513 / 03-F13N	MM-212-037-161-00Y5	M83513 / 03-G11C	MM-313-051-161-00Y3	M83513 / 03-H08P	MM-415-100-155-0000
M83513 / 03-F13P	MM-215-037-161-00Y5	M83513 / 03-G11N	MM-312-051-161-00Y3	M83513 / 03-H09C	MM-413-100-161-00Y1
M83513 / 03-F14C	MM-213-037-161-00Y6	M83513 / 03-G11P	MM-315-051-161-00Y3	M83513 / 03-H09N	MM-412-100-161-00Y1
M83513 / 03-F14N	MM-212-037-161-00Y6	M83513 / 03-G12C	MM-313-051-161-00Y4	M83513 / 03-H09P	MM-415-100-161-00Y1
M83513 / 03-F14P	MM-215-037-161-00Y6	M83513 / 03-G12N	MM-312-051-161-00Y4	M83513 / 03-H10C	MM-413-100-161-00Y2
M83513 / 03-F15C	MM-213-037-161-00Y7	M83513 / 03-G12P	MM-315-051-161-00Y4	M83513 / 03-H10N	MM-412-100-161-00Y2
M83513 / 03-F15N	MM-212-037-161-00Y7	M83513 / 03-G13C	MM-313-051-161-00Y5	M83513 / 03-H10P	MM-415-100-161-00Y2
M83513 / 03-F15P	MM-215-037-161-00Y7	M83513 / 03-G13N	MM-312-051-161-00Y5	M83513 / 03-H11C	MM-413-100-161-00Y3
M83513 / 03-F16C	MM-213-037-161-00Y8	M83513 / 03-G13P	MM-315-051-161-00Y5	M83513 / 03-H11N	MM-412-100-161-00Y3
M83513 / 03-F16N	MM-212-037-161-00Y8	M83513 / 03-G14C	MM-313-051-161-00Y6	M83513 / 03-H11P	MM-415-100-161-00Y3
M83513 / 03-F16P	MM-215-037-161-00Y8	M83513 / 03-G14N	MM-312-051-161-00Y6	M83513 / 03-H12C	MM-413-100-161-00Y4
		M83513 / 03-G14P	MM-315-051-161-00Y6	M83513 / 03-H12N	MM-412-100-161-00Y4
M83513 / 03-G01C	MM-313-051-161-00W1	M83513 / 03-G15C	MM-313-051-161-00Y7	M83513 / 03-H12P	MM-415-100-161-00Y4
M83513 / 03-G01N	MM-312-051-161-00W1	M83513 / 03-G15N	MM-312-051-161-00Y7	M83513 / 03-H13C	MM-413-100-161-00Y5
M83513 / 03-G01P	MM-315-051-161-00W1	M83513 / 03-G15P	MM-315-051-161-00Y7	M83513 / 03-H13N	MM-412-100-161-00Y5
M83513 / 03-G02C	MM-313-051-161-00W2	M83513 / 03-G16C	MM-313-051-161-00Y8	M83513 / 03-H13P	MM-415-100-161-00Y5
M83513 / 03-G02N	MM-312-051-161-00W2	M83513 / 03-G16N	MM-312-051-161-00Y8	M83513 / 03-H14C	MM-413-100-161-00Y6
M83513 / 03-G02P	MM-315-051-161-00W2	M83513 / 03-G16P	MM-315-051-161-00Y8	M83513 / 03-H14N	MM-412-100-161-00Y6
M83513 / 03-G03C	MM-313-051-161-00V1			M83513 / 03-H14P	MM-415-100-161-00Y6
M83513 / 03-G03N	MM-312-051-161-00V1	M83513 / 03-H01C	MM-413-100-161-00W1	M83513 / 03-H15C	MM-413-100-161-00Y7
M83513 / 03-G03P	MM-315-051-161-00V1	M83513 / 03-H01N	MM-412-100-161-00W1	M83513 / 03-H15N	MM-412-100-161-00Y7
M83513 / 03-G04C	MM-313-051-161-00V2	M83513 / 03-H01P	MM-415-100-161-00W1	M83513 / 03-H15P	MM-415-100-161-00Y7
M83513 / 03-G04N	MM-312-051-161-00V2	M83513 / 03-H02C	MM-413-100-161-00W2	M83513 / 03-H16C	MM-413-100-161-00Y8
M83513 / 03-G04P	MM-315-051-161-00V2	M83513 / 03-H02N	MM-412-100-161-00W2	M83513 / 03-H16N	MM-412-100-161-00Y8
M83513 / 03-G05C	MM-313-051-143-0000	M83513 / 03-H02P	MM-415-100-161-00W2	M83513 / 03-H16P	MM-415-100-161-00Y8
M83513 / 03-G05N	MM-312-051-143-0000	M83513 / 03-H03C	MM-413-100-161-00V1		

## M83513 / 04

M83513 / 04-A01C	MM-223-009-261-00W1-900	M83513 / 04-A05C	MM-223-009-243-0000-900	M83513 / 04-A09C	MM-223-009-261-00Y1-900
M83513 / 04-A01N	MM-222-009-261-00W1-900	M83513 / 04-A05N	MM-222-009-243-0000-900	M83513 / 04-A09N	MM-222-009-261-00Y1-900
M83513 / 04-A01P	MM-225-009-261-00W1-900	M83513 / 04-A05P	MM-225-009-243-0000-900	M83513 / 04-A09P	MM-225-009-261-00Y1-900
M83513 / 04-A02C	MM-223-009-261-00W2-900	M83513 / 04-A06C	MM-223-009-253-0000-900	M83513 / 04-A10C	MM-223-009-261-00Y2-900
M83513 / 04-A02N	MM-222-009-261-00W2-900	M83513 / 04-A06N	MM-222-009-253-0000-900	M83513 / 04-A10N	MM-222-009-261-00Y2-900
M83513 / 04-A02P	MM-225-009-261-00W2-900	M83513 / 04-A06P	MM-225-009-253-0000-900	M83513 / 04-A10P	MM-225-009-261-00Y2-900
M83513 / 04-A03C	MM-223-009-261-00V1-900	M83513 / 04-A07C	MM-223-009-245-0000-900	M83513 / 04-A11C	MM-223-009-261-00Y3-900
M83513 / 04-A03N	MM-222-009-261-00V1-900	M83513 / 04-A07N	MM-222-009-245-0000-900	M83513 / 04-A11N	MM-222-009-261-00Y3-900
M83513 / 04-A03P	MM-225-009-261-00V1-900	M83513 / 04-A07P	MM-225-009-245-0000-900	M83513 / 04-A11P	MM-225-009-261-00Y3-900
M83513 / 04-A04C	MM-223-009-261-00V2-900	M83513 / 04-A08C	MM-223-009-255-0000-900	M83513 / 04-A12C	MM-223-009-261-00Y4-900
M83513 / 04-A04N	MM-222-009-261-00V2-900	M83513 / 04-A08N	MM-222-009-255-0000-900	M83513 / 04-A12N	MM-222-009-261-00Y4-900
M83513 / 04-A04P	MM-225-009-261-00V2-900	M83513 / 04-A08P	MM-225-009-255-0000-900	M83513 / 04-A12P	MM-225-009-261-00Y4-900





## Military Cross Reference Chart

-- Continued from previous page

### M83513 / 04 (continued)

M83513 / 04-H09C	MM-423-100-261-00Y1-900	M83513 / 04-H11P	MM-425-100-261-00Y3-900	M83513 / 04-H14N	MM-422-100-261-00Y6-900
M83513 / 04-H09N	MM-422-100-261-00Y1-900	M83513 / 04-H12C	MM-423-100-261-00Y4-900	M83513 / 04-H14P	MM-425-100-261-00Y6-900
M83513 / 04-H09P	MM-425-100-261-00Y1-900	M83513 / 04-H12N	MM-422-100-261-00Y4-900	M83513 / 04-H15C	MM-423-100-261-00Y7-900
M83513 / 04-H10C	MM-423-100-261-00Y2-900	M83513 / 04-H12P	MM-425-100-261-00Y4-900	M83513 / 04-H15N	MM-422-100-261-00Y7-900
M83513 / 04-H10N	MM-422-100-261-00Y2-900	M83513 / 04-H13C	MM-423-100-261-00Y5-900	M83513 / 04-H15P	MM-425-100-261-00Y7-900
M83513 / 04-H10P	MM-425-100-261-00Y2-900	M83513 / 04-H13N	MM-422-100-261-00Y5-900	M83513 / 04-H16C	MM-423-100-261-00Y8-900
M83513 / 04-H11C	MM-423-100-261-00Y3-900	M83513 / 04-H13P	MM-425-100-261-00Y5-900	M83513 / 04-H16N	MM-422-100-261-00Y8-900
M83513 / 04-H11N	MM-422-100-261-00Y3-900	M83513 / 04-H14C	MM-423-100-261-00Y6-900	M83513 / 04-H16P	MM-425-100-261-00Y8-900

### M83513 / 05

M83513 / 05-02	00-000-000-000-4100
M83513 / 05-03	00-000-000-000-4200
M83513 / 05-05	00-000-000-000-4300
M83513 / 05-06	00-000-000-000-4400
M83513 / 05-07	00-000-000-000-2200
M83513 / 05-12	00-000-000-000-8100
M83513 / 05-13	00-000-000-000-8200
M83513 / 05-15	00-000-000-000-8300
M83513 / 05-16	00-000-000-000-8400
M83513 / 05-17	00-000-000-000-6200

### M83513 / 06

M83513 / 06-A	MP-211-009-113-0000
M83513 / 06-B	MP-211-015-113-0000
M83513 / 06-C	MP-211-021-113-0000
M83513 / 06-D	MP-211-025-113-0000
M83513 / 06-E	MP-211-031-113-0000
M83513 / 06-F	MP-211-037-113-0000
M83513 / 06-G	MP-311-051-113-0000

### M83513 / 07

M83513 / 07-A	MP-221-009-213-0000
M83513 / 07-B	MP-221-015-213-0000
M83513 / 07-C	MP-221-021-213-0000
M83513 / 07-D	MP-221-025-213-0000
M83513 / 07-E	MP-221-031-213-0000
M83513 / 07-F	MP-221-037-213-0000
M83513 / 07-G	MP-321-051-213-0000

### M83513 / 08

M83513 / 08-A01	MP-211-009-161-00W1	M83513 / 08-C01	MP-211-021-161-00W1	M83513 / 08-E01	MP-211-031-161-00W1
M83513 / 08-A02	MP-211-009-161-00W2	M83513 / 08-C02	MP-211-021-161-00W2	M83513 / 08-E02	MP-211-031-161-00W2
M83513 / 08-A03	MP-211-009-161-00V1	M83513 / 08-C03	MP-211-021-161-00V1	M83513 / 08-E03	MP-211-031-161-00V1
M83513 / 08-A04	MP-211-009-161-00V2	M83513 / 08-C04	MP-211-021-161-00V2	M83513 / 08-E04	MP-211-031-161-00V2
M83513 / 08-A05	MP-211-009-143-0000	M83513 / 08-C05	MP-211-021-143-0000	M83513 / 08-E05	MP-211-031-143-0000
M83513 / 08-A06	MP-211-009-153-0000	M83513 / 08-C06	MP-211-021-153-0000	M83513 / 08-E06	MP-211-031-153-0000
M83513 / 08-A07	MP-211-009-145-0000	M83513 / 08-C07	MP-211-021-145-0000	M83513 / 08-E07	MP-211-031-145-0000
M83513 / 08-A08	MP-211-009-155-0000	M83513 / 08-C08	MP-211-021-155-0000	M83513 / 08-E08	MP-211-031-155-0000
M83513 / 08-A09	MP-211-009-161-00Y1	M83513 / 08-C09	MP-211-021-161-00Y1	M83513 / 08-E09	MP-211-031-161-00Y1
M83513 / 08-A10	MP-211-009-161-00Y2	M83513 / 08-C10	MP-211-021-161-00Y2	M83513 / 08-E10	MP-211-031-161-00Y2
M83513 / 08-A11	MP-211-009-161-00Y3	M83513 / 08-C11	MP-211-021-161-00Y3	M83513 / 08-E11	MP-211-031-161-00Y3
M83513 / 08-A12	MP-211-009-161-00Y4	M83513 / 08-C12	MP-211-021-161-00Y4	M83513 / 08-E12	MP-211-031-161-00Y4
M83513 / 08-A13	MP-211-009-161-00Y5	M83513 / 08-C13	MP-211-021-161-00Y5	M83513 / 08-E13	MP-211-031-161-00Y5
M83513 / 08-A14	MP-211-009-161-00Y6	M83513 / 08-C14	MP-211-021-161-00Y6	M83513 / 08-E14	MP-211-031-161-00Y6
M83513 / 08-A15	MP-211-009-161-00Y7	M83513 / 08-C15	MP-211-021-161-00Y7	M83513 / 08-E15	MP-211-031-161-00Y7
M83513 / 08-A16	MP-211-009-161-00Y8	M83513 / 08-C16	MP-211-021-161-00Y8	M83513 / 08-E16	MP-211-031-161-00Y8

M83513 / 08-B01	MP-211-015-161-00W1
M83513 / 08-B02	MP-211-015-161-00W2
M83513 / 08-B03	MP-211-015-161-00V1
M83513 / 08-B04	MP-211-015-161-00V2
M83513 / 08-B05	MP-211-015-143-0000
M83513 / 08-B06	MP-211-015-153-0000
M83513 / 08-B07	MP-211-015-145-0000
M83513 / 08-B08	MP-211-015-155-0000
M83513 / 08-B09	MP-211-015-161-00Y1
M83513 / 08-B10	MP-211-015-161-00Y2
M83513 / 08-B11	MP-211-015-161-00Y3
M83513 / 08-B12	MP-211-015-161-00Y4
M83513 / 08-B13	MP-211-015-161-00Y5
M83513 / 08-B14	MP-211-015-161-00Y6
M83513 / 08-B15	MP-211-015-161-00Y7
M83513 / 08-B16	MP-211-015-161-00Y8

M83513 / 08-D01	MP-211-025-161-00W1
M83513 / 08-D02	MP-211-025-161-00W2
M83513 / 08-D03	MP-211-025-161-00V1
M83513 / 08-D04	MP-211-025-161-00V2
M83513 / 08-D05	MP-211-025-143-0000
M83513 / 08-D06	MP-211-025-153-0000
M83513 / 08-D07	MP-211-025-145-0000
M83513 / 08-D08	MP-211-025-155-0000
M83513 / 08-D09	MP-211-025-161-00Y1
M83513 / 08-D10	MP-211-025-161-00Y2
M83513 / 08-D11	MP-211-025-161-00Y3
M83513 / 08-D12	MP-211-025-161-00Y4
M83513 / 08-D13	MP-211-025-161-00Y5
M83513 / 08-D14	MP-211-025-161-00Y6
M83513 / 08-D15	MP-211-025-161-00Y7
M83513 / 08-D16	MP-211-025-161-00Y8

M83513 / 08-F01	MP-211-037-161-00W1
M83513 / 08-F02	MP-211-037-161-00W2
M83513 / 08-F03	MP-211-037-161-00V1
M83513 / 08-F04	MP-211-037-161-00V2
M83513 / 08-F05	MP-211-037-143-0000
M83513 / 08-F06	MP-211-037-153-0000
M83513 / 08-F07	MP-211-037-145-0000
M83513 / 08-F08	MP-211-037-155-0000
M83513 / 08-F09	MP-211-037-161-00Y1
M83513 / 08-F10	MP-211-037-161-00Y2
M83513 / 08-F11	MP-211-037-161-00Y3
M83513 / 08-F12	MP-211-037-161-00Y4
M83513 / 08-F13	MP-211-037-161-00Y5
M83513 / 08-F14	MP-211-037-161-00Y6
M83513 / 08-F15	MP-211-037-161-00Y7
M83513 / 08-F16	MP-211-037-161-00Y8



## Military Cross Reference Chart

-- Continued from previous page

### M83513 / 08 (continued)

M83513 / 08-G01	MP-311-051-161-00W1	M83513 / 08-G07	MP-311-051-145-0000	M83513 / 08-G13	MP-311-051-161-00Y5
M83513 / 08-G02	MP-311-051-161-00W2	M83513 / 08-G08	MP-311-051-155-0000	M83513 / 08-G14	MP-311-051-161-00Y6
M83513 / 08-G03	MP-311-051-161-00V1	M83513 / 08-G09	MP-311-051-161-00Y1	M83513 / 08-G15	MP-311-051-161-00Y7
M83513 / 08-G04	MP-311-051-161-00V2	M83513 / 08-G10	MP-311-051-161-00Y2	M83513 / 08-G16	MP-311-051-161-00Y8
M83513 / 08-G05	MP-311-051-143-0000	M83513 / 08-G11	MP-311-051-161-00Y3		
M83513 / 08-G06	MP-311-051-153-0000	M83513 / 08-G12	MP-311-051-161-00Y4		

### M83513 / 09

M83513 / 09-A01	MP-221-009-261-00W1	M83513 / 09-C07	MP-221-021-245-0000	M83513 / 09-E12	MP-221-031-261-00Y4
M83513 / 09-A02	MP-221-009-261-00W2	M83513 / 09-C08	MP-221-021-255-0000	M83513 / 09-E13	MP-221-031-261-00Y5
M83513 / 09-A03	MP-221-009-261-00V1	M83513 / 09-C09	MP-221-021-261-00Y1	M83513 / 09-E14	MP-221-031-261-00Y6
M83513 / 09-A04	MP-221-009-261-00V2	M83513 / 09-C10	MP-221-021-261-00Y2	M83513 / 09-E15	MP-221-031-261-00Y7
M83513 / 09-A05	MP-221-009-243-0000	M83513 / 09-C11	MP-221-021-261-00Y3	M83513 / 09-E16	MP-221-031-261-00Y8
M83513 / 09-A06	MP-221-009-253-0000	M83513 / 09-C12	MP-221-021-261-00Y4		
M83513 / 09-A07	MP-221-009-245-0000	M83513 / 09-C13	MP-221-021-261-00Y5	M83513 / 09-F01	MP-221-037-261-00W1
M83513 / 09-A08	MP-221-009-255-0000	M83513 / 09-C14	MP-221-021-261-00Y6	M83513 / 09-F02	MP-221-037-261-00W2
M83513 / 09-A09	MP-221-009-261-00Y1	M83513 / 09-C15	MP-221-021-261-00Y7	M83513 / 09-F03	MP-221-037-261-00V1
M83513 / 09-A10	MP-221-009-261-00Y2	M83513 / 09-C16	MP-221-021-261-00Y8	M83513 / 09-F04	MP-221-037-261-00V2
M83513 / 09-A11	MP-221-009-261-00Y3			M83513 / 09-F05	MP-221-037-243-0000
M83513 / 09-A12	MP-221-009-261-00Y4	M83513 / 09-D01	MP-221-025-261-00W1	M83513 / 09-F06	MP-221-037-253-0000
M83513 / 09-A13	MP-221-009-261-00Y5	M83513 / 09-D02	MP-221-025-261-00W2	M83513 / 09-F07	MP-221-037-245-0000
M83513 / 09-A14	MP-221-009-261-00Y6	M83513 / 09-D03	MP-221-025-261-00V1	M83513 / 09-F08	MP-221-037-255-0000
M83513 / 09-A15	MP-221-009-261-00Y7	M83513 / 09-D04	MP-221-025-261-00V2	M83513 / 09-F09	MP-221-037-261-00Y1
M83513 / 09-A16	MP-221-009-261-00Y8	M83513 / 09-D05	MP-221-025-243-0000	M83513 / 09-F10	MP-221-037-261-00Y2
		M83513 / 09-D06	MP-221-025-253-0000	M83513 / 09-F11	MP-221-037-261-00Y3
M83513 / 09-B01	MP-221-015-261-00W1	M83513 / 09-D07	MP-221-025-245-0000	M83513 / 09-F12	MP-221-037-261-00Y4
M83513 / 09-B02	MP-221-015-261-00W2	M83513 / 09-D08	MP-221-025-255-0000	M83513 / 09-F13	MP-221-037-261-00Y5
M83513 / 09-B03	MP-221-015-261-00V1	M83513 / 09-D09	MP-221-025-261-00Y1	M83513 / 09-F14	MP-221-037-261-00Y6
M83513 / 09-B04	MP-221-015-261-00V2	M83513 / 09-D10	MP-221-025-261-00Y2	M83513 / 09-F15	MP-221-037-261-00Y7
M83513 / 09-B05	MP-221-015-243-0000	M83513 / 09-D11	MP-221-025-261-00Y3	M83513 / 09-F16	MP-221-037-261-00Y8
M83513 / 09-B06	MP-221-015-253-0000	M83513 / 09-D12	MP-221-025-261-00Y4		
M83513 / 09-B07	MP-221-015-245-0000	M83513 / 09-D13	MP-221-025-261-00Y5	M83513 / 09-G01	MP-321-051-261-00W1
M83513 / 09-B08	MP-221-015-255-0000	M83513 / 09-D14	MP-221-025-261-00Y6	M83513 / 09-G02	MP-321-051-261-00W2
M83513 / 09-B09	MP-221-015-261-00Y1	M83513 / 09-D15	MP-221-025-261-00Y7	M83513 / 09-G03	MP-321-051-261-00V1
M83513 / 09-B10	MP-221-015-261-00Y2	M83513 / 09-D16	MP-221-025-261-00Y8	M83513 / 09-G04	MP-321-051-261-00V2
M83513 / 09-B11	MP-221-015-261-00Y3			M83513 / 09-G05	MP-321-051-243-0000
M83513 / 09-B12	MP-221-015-261-00Y4	M83513 / 09-E01	MP-221-031-261-00W1	M83513 / 09-G06	MP-321-051-253-0000
M83513 / 09-B13	MP-221-015-261-00Y5	M83513 / 09-E02	MP-221-031-261-00W2	M83513 / 09-G07	MP-321-051-245-0000
M83513 / 09-B14	MP-221-015-261-00Y6	M83513 / 09-E03	MP-221-031-261-00V1	M83513 / 09-G08	MP-321-051-255-0000
M83513 / 09-B15	MP-221-015-261-00Y7	M83513 / 09-E04	MP-221-031-261-00V2	M83513 / 09-G09	MP-321-051-261-00Y1
M83513 / 09-B16	MP-221-015-261-00Y8	M83513 / 09-E05	MP-221-031-243-0000	M83513 / 09-G10	MP-321-051-261-00Y2
		M83513 / 09-E06	MP-221-031-253-0000	M83513 / 09-G11	MP-321-051-261-00Y3
M83513 / 09-C01	MP-221-021-261-00W1	M83513 / 09-E07	MP-221-031-245-0000	M83513 / 09-G12	MP-321-051-261-00Y4
M83513 / 09-C02	MP-221-021-261-00W2	M83513 / 09-E08	MP-221-031-255-0000	M83513 / 09-G13	MP-321-051-261-00Y5
M83513 / 09-C03	MP-221-021-261-00V1	M83513 / 09-E09	MP-221-031-261-00Y1	M83513 / 09-G14	MP-321-051-261-00Y6
M83513 / 09-C04	MP-221-021-261-00V2	M83513 / 09-E10	MP-221-031-261-00Y2	M83513 / 09-G15	MP-321-051-261-00Y7
M83513 / 09-C05	MP-221-021-243-0000	M83513 / 09-E11	MP-221-031-261-00Y3	M83513 / 09-G16	MP-321-051-261-00Y8
M83513 / 09-C06	MP-221-021-253-0000				

### M83513 / 10

M83513 / 10-A01CN	MK-2R3-009-325-000S	M83513 / 10-A01NT	MK-2R2-009-325-000S-0B7	M83513 / 10-A02CN	MK-2R3-009-335-000S
M83513 / 10-A01CP	MK-2R3-009-325-220S	M83513 / 10-A01NW	MK-2R2-009-325-220S-0B7	M83513 / 10-A02CP	MK-2R3-009-335-220S
M83513 / 10-A01CT	MK-2R3-009-325-000S-0B7	M83513 / 10-A01PN	MK-2R5-009-325-000S	M83513 / 10-A02CT	MK-2R3-009-335-000S-0B7
M83513 / 10-A01CW	MK-2R3-009-325-220S-0B7	M83513 / 10-A01PP	MK-2R5-009-325-220S	M83513 / 10-A02CW	MK-2R3-009-335-220S-0B7
M83513 / 10-A01NN	MK-2R2-009-325-000S	M83513 / 10-A01PT	MK-2R5-009-325-000S-0B7	M83513 / 10-A02NN	MK-2R2-009-335-000S
M83513 / 10-A01NP	MK-2R2-009-325-220S	M83513 / 10-A01PW	MK-2R5-009-325-220S-0B7	M83513 / 10-A02NP	MK-2R2-009-335-220S

## Military Cross Reference Chart

– Continued from previous page

### M83513 / 10 (continued)

M83513 / 10-A02NT	MK-2R2-009-335-000S-OB7	M83513 / 10-C01CN	MK-2R3-021-325-000S	M83513 / 10-D02NW	MK-2R2-025-335-220S-OB7
M83513 / 10-A02NW	MK-2R2-009-335-220S-OB7	M83513 / 10-C01CP	MK-2R3-021-325-220S	M83513 / 10-D02PN	MK-2R5-025-335-000S
M83513 / 10-A02PN	MK-2R5-009-335-000S	M83513 / 10-C01CT	MK-2R3-021-325-000S-OB7	M83513 / 10-D02PP	MK-2R5-025-335-220S
M83513 / 10-A02PP	MK-2R5-009-335-220S	M83513 / 10-C01CW	MK-2R3-021-325-220S-OB7	M83513 / 10-D02PT	MK-2R5-025-335-000S-OB7
M83513 / 10-A02PT	MK-2R5-009-335-000S-OB7	M83513 / 10-C01NN	MK-2R2-021-325-000S	M83513 / 10-D02PW	MK-2R5-025-335-220S-OB7
M83513 / 10-A02PW	MK-2R5-009-335-220S-OB7	M83513 / 10-C01NP	MK-2R2-021-325-220S	M83513 / 10-D03CN	MK-2R3-025-345-000S
M83513 / 10-A03CN	MK-2R3-009-345-000S	M83513 / 10-C01NT	MK-2R2-021-325-000S-OB7	M83513 / 10-D03CP	MK-2R3-025-345-220S
M83513 / 10-A03CP	MK-2R3-009-345-220S	M83513 / 10-C01NW	MK-2R2-021-325-220S-OB7	M83513 / 10-D03CT	MK-2R3-025-345-000S-OB7
M83513 / 10-A03CT	MK-2R3-009-345-000S-OB7	M83513 / 10-C01PN	MK-2R5-021-325-000S	M83513 / 10-D03CW	MK-2R3-025-345-220S-OB7
M83513 / 10-A03CW	MK-2R3-009-345-220S-OB7	M83513 / 10-C01PP	MK-2R5-021-325-220S	M83513 / 10-D03NN	MK-2R2-025-345-000S
M83513 / 10-A03NN	MK-2R2-009-345-000S	M83513 / 10-C01PT	MK-2R5-021-325-000S-OB7	M83513 / 10-D03NP	MK-2R2-025-345-220S
M83513 / 10-A03NP	MK-2R2-009-345-220S	M83513 / 10-C01PW	MK-2R5-021-325-220S-OB7	M83513 / 10-D03NT	MK-2R2-025-345-000S-OB7
M83513 / 10-A03NT	MK-2R2-009-345-000S-OB7	M83513 / 10-C02CN	MK-2R3-021-335-000S	M83513 / 10-D03NW	MK-2R2-025-345-220S-OB7
M83513 / 10-A03NW	MK-2R2-009-345-220S-OB7	M83513 / 10-C02CP	MK-2R3-021-335-220S	M83513 / 10-D03PN	MK-2R5-025-345-000S
M83513 / 10-A03PN	MK-2R5-009-345-000S	M83513 / 10-C02CT	MK-2R3-021-335-000S-OB7	M83513 / 10-D03PP	MK-2R5-025-345-220S
M83513 / 10-A03PP	MK-2R5-009-345-220S	M83513 / 10-C02CW	MK-2R3-021-335-220S-OB7	M83513 / 10-D03PT	MK-2R5-025-345-000S-OB7
M83513 / 10-A03PT	MK-2R5-009-345-000S-OB7	M83513 / 10-C02NN	MK-2R2-021-335-000S	M83513 / 10-D03PW	MK-2R5-025-345-220S-OB7
M83513 / 10-A03PW	MK-2R5-009-345-220S-OB7	M83513 / 10-C02NP	MK-2R2-021-335-220S		
		M83513 / 10-C02NT	MK-2R2-021-335-000S-OB7	M83513 / 10-E01CN	MK-2R3-031-325-000S
M83513 / 10-B01CN	MK-2R3-015-325-000S	M83513 / 10-C02NW	MK-2R2-021-335-220S-OB7	M83513 / 10-E01CP	MK-2R3-031-325-220S
M83513 / 10-B01CP	MK-2R3-015-325-220S	M83513 / 10-C02PN	MK-2R5-021-335-000S	M83513 / 10-E01CT	MK-2R3-031-325-000S-OB7
M83513 / 10-B01CT	MK-2R3-015-325-000S-OB7	M83513 / 10-C02PP	MK-2R5-021-335-220S	M83513 / 10-E01CW	MK-2R3-031-325-220S-OB7
M83513 / 10-B01CW	MK-2R3-015-325-220S-OB7	M83513 / 10-C02PT	MK-2R5-021-335-000S-OB7	M83513 / 10-E01NN	MK-2R2-031-325-000S
M83513 / 10-B01NN	MK-2R2-015-325-000S	M83513 / 10-C02PW	MK-2R5-021-335-220S-OB7	M83513 / 10-E01NP	MK-2R2-031-325-220S
M83513 / 10-B01NP	MK-2R2-015-325-220S	M83513 / 10-C03CN	MK-2R3-021-345-000S	M83513 / 10-E01NT	MK-2R2-031-325-000S-OB7
M83513 / 10-B01NT	MK-2R2-015-325-000S-OB7	M83513 / 10-C03CP	MK-2R3-021-345-220S	M83513 / 10-E01NW	MK-2R2-031-325-220S-OB7
M83513 / 10-B01NW	MK-2R2-015-325-220S-OB7	M83513 / 10-C03CT	MK-2R3-021-345-000S-OB7	M83513 / 10-E01PN	MK-2R5-031-325-000S
M83513 / 10-B01PN	MK-2R5-015-325-000S	M83513 / 10-C03CW	MK-2R3-021-345-220S-OB7	M83513 / 10-E01PP	MK-2R5-031-325-220S
M83513 / 10-B01PP	MK-2R5-015-325-220S	M83513 / 10-C03NN	MK-2R2-021-345-000S	M83513 / 10-E01PT	MK-2R5-031-325-000S-OB7
M83513 / 10-B01PT	MK-2R5-015-325-000S-OB7	M83513 / 10-C03NP	MK-2R2-021-345-220S	M83513 / 10-E01PW	MK-2R5-031-325-220S-OB7
M83513 / 10-B01PW	MK-2R5-015-325-220S-OB7	M83513 / 10-C03NT	MK-2R2-021-345-000S-OB7	M83513 / 10-E02CN	MK-2R3-031-335-000S
M83513 / 10-B02CN	MK-2R3-015-335-000S	M83513 / 10-C03NW	MK-2R2-021-345-220S-OB7	M83513 / 10-E02CP	MK-2R3-031-335-220S
M83513 / 10-B02CP	MK-2R3-015-335-220S	M83513 / 10-C03PN	MK-2R5-021-345-000S	M83513 / 10-E02CT	MK-2R3-031-335-000S-OB7
M83513 / 10-B02CT	MK-2R3-015-335-000S-OB7	M83513 / 10-C03PP	MK-2R5-021-345-220S	M83513 / 10-E02CW	MK-2R3-031-335-220S-OB7
M83513 / 10-B02CW	MK-2R3-015-335-220S-OB7	M83513 / 10-C03PT	MK-2R5-021-345-000S-OB7	M83513 / 10-E02NN	MK-2R2-031-335-000S
M83513 / 10-B02NN	MK-2R2-015-335-000S	M83513 / 10-C03PW	MK-2R5-021-345-220S-OB7	M83513 / 10-E02NP	MK-2R2-031-335-220S
M83513 / 10-B02NP	MK-2R2-015-335-220S			M83513 / 10-E02NT	MK-2R2-031-335-000S-OB7
M83513 / 10-B02NT	MK-2R2-015-335-000S-OB7	M83513 / 10-D01CN	MK-2R3-025-325-000S	M83513 / 10-E02NW	MK-2R2-031-335-220S-OB7
M83513 / 10-B02NW	MK-2R2-015-335-220S-OB7	M83513 / 10-D01CP	MK-2R3-025-325-220S	M83513 / 10-E02PN	MK-2R5-031-335-000S
M83513 / 10-B02PN	MK-2R5-015-335-000S	M83513 / 10-D01CT	MK-2R3-025-325-000S-OB7	M83513 / 10-E02PP	MK-2R5-031-335-220S
M83513 / 10-B02PP	MK-2R5-015-335-220S	M83513 / 10-D01CW	MK-2R3-025-325-220S-OB7	M83513 / 10-E02PT	MK-2R5-031-335-000S-OB7
M83513 / 10-B02PT	MK-2R5-015-335-000S-OB7	M83513 / 10-D01NN	MK-2R2-025-325-000S	M83513 / 10-E02PW	MK-2R5-031-335-220S-OB7
M83513 / 10-B02PW	MK-2R5-015-335-220S-OB7	M83513 / 10-D01NP	MK-2R2-025-325-220S	M83513 / 10-E03CN	MK-2R3-031-345-000S
M83513 / 10-B03CN	MK-2R3-015-345-000S	M83513 / 10-D01NT	MK-2R2-025-325-000S-OB7	M83513 / 10-E03CP	MK-2R3-031-345-220S
M83513 / 10-B03CP	MK-2R3-015-345-220S	M83513 / 10-D01NW	MK-2R2-025-325-220S-OB7	M83513 / 10-E03CT	MK-2R3-031-345-000S-OB7
M83513 / 10-B03CT	MK-2R3-015-345-000S-OB7	M83513 / 10-D01PN	MK-2R5-025-325-000S	M83513 / 10-E03CW	MK-2R3-031-345-220S-OB7
M83513 / 10-B03CW	MK-2R3-015-345-220S-OB7	M83513 / 10-D01PP	MK-2R5-025-325-220S	M83513 / 10-E03NN	MK-2R2-031-345-000S
M83513 / 10-B03NN	MK-2R2-015-345-000S	M83513 / 10-D01PT	MK-2R5-025-325-000S-OB7	M83513 / 10-E03NP	MK-2R2-031-345-220S
M83513 / 10-B03NP	MK-2R2-015-345-220S	M83513 / 10-D01PW	MK-2R5-025-325-220S-OB7	M83513 / 10-E03NT	MK-2R2-031-345-000S-OB7
M83513 / 10-B03NT	MK-2R2-015-345-000S-OB7	M83513 / 10-D02CN	MK-2R3-025-335-000S	M83513 / 10-E03NW	MK-2R2-031-345-220S-OB7
M83513 / 10-B03NW	MK-2R2-015-345-220S-OB7	M83513 / 10-D02CP	MK-2R3-025-335-220S	M83513 / 10-E03PN	MK-2R5-031-345-000S
M83513 / 10-B03PN	MK-2R5-015-345-000S	M83513 / 10-D02CT	MK-2R3-025-335-000S-OB7	M83513 / 10-E03PP	MK-2R5-031-345-220S
M83513 / 10-B03PP	MK-2R5-015-345-220S	M83513 / 10-D02CW	MK-2R3-025-335-220S-OB7	M83513 / 10-E03PT	MK-2R5-031-345-000S-OB7
M83513 / 10-B03PT	MK-2R5-015-345-000S-OB7	M83513 / 10-D02NN	MK-2R2-025-335-000S	M83513 / 10-E03PW	MK-2R5-031-345-220S-OB7
M83513 / 10-B03PW	MK-2R5-015-345-220S-OB7	M83513 / 10-D02NP	MK-2R2-025-335-220S		
		M83513 / 10-D02NT	MK-2R2-025-335-000S-OB7		



## Military Cross Reference Chart

-- Continued from previous page

### M83513 / 10 (continued)

M83513 / 10-F01CN	MK-2R3-037-325-000S	M83513 / 10-F02CN	MK-2R3-037-335-000S	M83513 / 10-F03CN	MK-2R3-037-345-000S
M83513 / 10-F01CP	MK-2R3-037-325-220S	M83513 / 10-F02CP	MK-2R3-037-335-220S	M83513 / 10-F03CP	MK-2R3-037-345-220S
M83513 / 10-F01CT	MK-2R3-037-325-000S-OB7	M83513 / 10-F02CT	MK-2R3-037-335-000S-OB7	M83513 / 10-F03CT	MK-2R3-037-345-000S-OB7
M83513 / 10-F01CW	MK-2R3-037-325-220S-OB7	M83513 / 10-F02CW	MK-2R3-037-335-220S-OB7	M83513 / 10-F03CW	MK-2R3-037-345-220S-OB7
M83513 / 10-F01NN	MK-2R2-037-325-000S	M83513 / 10-F02NN	MK-2R2-037-335-000S	M83513 / 10-F03NN	MK-2R2-037-345-000S
M83513 / 10-F01NP	MK-2R2-037-325-220S	M83513 / 10-F02NP	MK-2R2-037-335-220S	M83513 / 10-F03NP	MK-2R2-037-345-220S
M83513 / 10-F01NT	MK-2R2-037-325-000S-OB7	M83513 / 10-F02NT	MK-2R2-037-335-000S-OB7	M83513 / 10-F03NT	MK-2R2-037-345-000S-OB7
M83513 / 10-F01NW	MK-2R2-037-325-220S-OB7	M83513 / 10-F02NW	MK-2R2-037-335-220S-OB7	M83513 / 10-F03NW	MK-2R2-037-345-220S-OB7
M83513 / 10-F01PN	MK-2R5-037-325-000S	M83513 / 10-F02PN	MK-2R5-037-335-000S	M83513 / 10-F03PN	MK-2R5-037-345-000S
M83513 / 10-F01PP	MK-2R5-037-325-220S	M83513 / 10-F02PP	MK-2R5-037-335-220S	M83513 / 10-F03PP	MK-2R5-037-345-220S
M83513 / 10-F01PT	MK-2R5-037-325-000S-OB7	M83513 / 10-F02PT	MK-2R5-037-335-000S-OB7	M83513 / 10-F03PT	MK-2R5-037-345-000S-OB7
M83513 / 10-F01PW	MK-2R5-037-325-220S-OB7	M83513 / 10-F02PW	MK-2R5-037-335-220S-OB7	M83513 / 10-F03PW	MK-2R5-037-345-220S-OB7

### M83513 / 11

M83513 / 11-G01CN	MK-3R3-051-325-000S	M83513 / 11-G02CN	MK-3R3-051-335-000S	M83513 / 11-G03CN	MK-3R3-051-345-000S
M83513 / 11-G01CP	MK-3R3-051-325-220S	M83513 / 11-G02CP	MK-3R3-051-335-220S	M83513 / 11-G03CP	MK-3R3-051-345-220S
M83513 / 11-G01CT	MK-3R3-051-325-000S-OB7	M83513 / 11-G02CT	MK-3R3-051-335-000S-OB7	M83513 / 11-G03CT	MK-3R3-051-345-000S-OB7
M83513 / 11-G01CW	MK-3R3-051-325-220S-OB7	M83513 / 11-G02CW	MK-3R3-051-335-220S-OB7	M83513 / 11-G03CW	MK-3R3-051-345-220S-OB7
M83513 / 11-G01NN	MK-3R2-051-325-000S	M83513 / 11-G02NN	MK-3R2-051-335-000S	M83513 / 11-G03NN	MK-3R2-051-345-000S
M83513 / 11-G01NP	MK-3R2-051-325-220S	M83513 / 11-G02NP	MK-3R2-051-335-220S	M83513 / 11-G03NP	MK-3R2-051-345-220S
M83513 / 11-G01NT	MK-3R2-051-325-000S-OB7	M83513 / 11-G02NT	MK-3R2-051-335-000S-OB7	M83513 / 11-G03NT	MK-3R2-051-345-000S-OB7
M83513 / 11-G01NW	MK-3R2-051-325-220S-OB7	M83513 / 11-G02NW	MK-3R2-051-335-220S-OB7	M83513 / 11-G03NW	MK-3R2-051-345-220S-OB7
M83513 / 11-G01PN	MK-3R5-051-325-000S	M83513 / 11-G02PN	MK-3R5-051-335-000S	M83513 / 11-G03PN	MK-3R5-051-345-000S
M83513 / 11-G01PP	MK-3R5-051-325-220S	M83513 / 11-G02PP	MK-3R5-051-335-220S	M83513 / 11-G03PP	MK-3R5-051-345-220S
M83513 / 11-G01PT	MK-3R5-051-325-000S-OB7	M83513 / 11-G02PT	MK-3R5-051-335-000S-OB7	M83513 / 11-G03PT	MK-3R5-051-345-000S-OB7
M83513 / 11-G01PW	MK-3R5-051-325-220S-OB7	M83513 / 11-G02PW	MK-3R5-051-335-220S-OB7	M83513 / 11-G03PW	MK-3R5-051-345-220S-OB7

### M83513 / 12

M83513 / 12-H01CN	MK-4R3-100-325-000S-94P	M83513 / 12-H02CN	MK-4R3-100-335-000S-94P	M83513 / 12-H03CN	MK-4R3-100-345-000S-94P
M83513 / 12-H01CP	MK-4R3-100-325-620S-94P	M83513 / 12-H02CP	MK-4R3-100-335-620S-94P	M83513 / 12-H03CP	MK-4R3-100-345-620S-94P
M83513 / 12-H01CT	MK-4R3-100-325-000S-OB7	M83513 / 12-H02CT	MK-4R3-100-335-000S-OB7	M83513 / 12-H03CT	MK-4R3-100-345-000S-OB7
M83513 / 12-H01CW	MK-4R3-100-325-620S-OB7	M83513 / 12-H02CW	MK-4R3-100-335-620S-OB7	M83513 / 12-H03CW	MK-4R3-100-345-620S-OB7
M83513 / 12-H01NN	MK-4R2-100-325-000S-94P	M83513 / 12-H02NN	MK-4R2-100-335-000S-94P	M83513 / 12-H03NN	MK-4R2-100-345-000S-94P
M83513 / 12-H01NP	MK-4R2-100-325-620S-94P	M83513 / 12-H02NP	MK-4R2-100-335-620S-94P	M83513 / 12-H03NP	MK-4R2-100-345-620S-94P
M83513 / 12-H01NT	MK-4R2-100-325-000S-OB7	M83513 / 12-H02NT	MK-4R2-100-335-000S-OB7	M83513 / 12-H03NT	MK-4R2-100-345-000S-OB7
M83513 / 12-H01NW	MK-4R2-100-325-620S-OB7	M83513 / 12-H02NW	MK-4R2-100-335-620S-OB7	M83513 / 12-H03NW	MK-4R2-100-345-620S-OB7
M83513 / 12-H01PN	MK-4R5-100-325-000S-94P	M83513 / 12-H02PN	MK-4R5-100-335-000S-94P	M83513 / 12-H03PN	MK-4R5-100-345-000S-94P
M83513 / 12-H01PP	MK-4R5-100-325-620S-94P	M83513 / 12-H02PP	MK-4R5-100-335-620S-94P	M83513 / 12-H03PP	MK-4R5-100-345-620S-94P
M83513 / 12-H01PT	MK-4R5-100-325-000S-OB7	M83513 / 12-H02PT	MK-4R5-100-335-000S-OB7	M83513 / 12-H03PT	MK-4R5-100-345-000S-OB7
M83513 / 12-H01PW	MK-4R5-100-325-620S-OB7	M83513 / 12-H02PW	MK-4R5-100-335-620S-OB7	M83513 / 12-H03PW	MK-4R5-100-345-620S-OB7

### M83513 / 13

M83513 / 13-A01CN	MK-2S3-009-435-000S-900	M83513 / 13-A02CN	MK-2S3-009-445-000S-900	M83513 / 13-A03CN	MK-2S3-009-455-000S-900
M83513 / 13-A01CP	MK-2S3-009-435-220S-900	M83513 / 13-A02CP	MK-2S3-009-445-220S-900	M83513 / 13-A03CP	MK-2S3-009-455-220S-900
M83513 / 13-A01CT	MK-2S3-009-435-000S-OB7	M83513 / 13-A02CT	MK-2S3-009-445-000S-OB7	M83513 / 13-A03CT	MK-2S3-009-455-000S-OB7
M83513 / 13-A01CW	MK-2S3-009-435-220S-OB7	M83513 / 13-A02CW	MK-2S3-009-445-220S-OB7	M83513 / 13-A03CW	MK-2S3-009-455-220S-OB7
M83513 / 13-A01NN	MK-2S2-009-435-000S-900	M83513 / 13-A02NN	MK-2S2-009-445-000S-900	M83513 / 13-A03NN	MK-2S2-009-455-000S-900
M83513 / 13-A01NP	MK-2S2-009-435-220S-900	M83513 / 13-A02NP	MK-2S2-009-445-220S-900	M83513 / 13-A03NP	MK-2S2-009-455-220S-900
M83513 / 13-A01NT	MK-2S2-009-435-000S-OB7	M83513 / 13-A02NT	MK-2S2-009-445-000S-OB7	M83513 / 13-A03NT	MK-2S2-009-455-000S-OB7
M83513 / 13-A01NW	MK-2S2-009-435-220S-OB7	M83513 / 13-A02NW	MK-2S2-009-445-220S-OB7	M83513 / 13-A03NW	MK-2S2-009-455-220S-OB7
M83513 / 13-A01PN	MK-2S5-009-435-000S-900	M83513 / 13-A02PN	MK-2S5-009-445-000S-900	M83513 / 13-A03PN	MK-2S5-009-455-000S-900
M83513 / 13-A01PP	MK-2S5-009-435-220S-900	M83513 / 13-A02PP	MK-2S5-009-445-220S-900	M83513 / 13-A03PP	MK-2S5-009-455-220S-900
M83513 / 13-A01PT	MK-2S5-009-435-000S-OB7	M83513 / 13-A02PT	MK-2S5-009-445-000S-OB7	M83513 / 13-A03PT	MK-2S5-009-455-000S-OB7
M83513 / 13-A01PW	MK-2S5-009-435-220S-OB7	M83513 / 13-A02PW	MK-2S5-009-445-220S-OB7	M83513 / 13-A03PW	MK-2S5-009-455-220S-OB7





## Military Cross Reference Chart

– Continued from previous page

### M83513 / 13 (continued)

M83513 / 13-F02NT	MK-2S2-037-445-000S-0B7	M83513 / 13-F03CN	MK-2S3-037-455-000S-900	M83513 / 13-F03NT	MK-2S2-037-455-000S-0B7
M83513 / 13-F02NW	MK-2S2-037-445-220S-0B7	M83513 / 13-F03CP	MK-2S3-037-455-220S-900	M83513 / 13-F03NW	MK-2S2-037-455-220S-0B7
M83513 / 13-F02PN	MK-2S5-037-445-000S-900	M83513 / 13-F03CT	MK-2S3-037-455-000S-0B7	M83513 / 13-F03PN	MK-2S5-037-455-000S-900
M83513 / 13-F02PP	MK-2S5-037-445-220S-900	M83513 / 13-F03CW	MK-2S3-037-455-220S-0B7	M83513 / 13-F03PP	MK-2S5-037-455-220S-900
M83513 / 13-F02PT	MK-2S5-037-445-000S-0B7	M83513 / 13-F03NN	MK-2S2-037-455-000S-900	M83513 / 13-F03PT	MK-2S5-037-455-000S-0B7
M83513 / 13-F02PW	MK-2S5-037-445-220S-0B7	M83513 / 13-F03NP	MK-2S2-037-455-220S-900	M83513 / 13-F03PW	MK-2S5-037-455-220S-0B7

### M83513 / 14

M83513 / 14-G01CN	MK-3S3-051-435-000S-900	M83513 / 14-G02CN	MK-3S3-051-445-000S-900	M83513 / 14-G03CN	MK-3S3-051-455-000S-900
M83513 / 14-G01CP	MK-3S3-051-435-220S-900	M83513 / 14-G02CP	MK-3S3-051-445-220S-900	M83513 / 14-G03CP	MK-3S3-051-455-220S-900
M83513 / 14-G01CT	MK-3S3-051-435-000S-0B7	M83513 / 14-G02CT	MK-3S3-051-445-000S-0B7	M83513 / 14-G03CT	MK-3S3-051-455-000S-0B7
M83513 / 14-G01CW	MK-3S3-051-435-220S-0B7	M83513 / 14-G02CW	MK-3S3-051-445-220S-0B7	M83513 / 14-G03CW	MK-3S3-051-455-220S-0B7
M83513 / 14-G01NN	MK-3S2-051-435-000S-900	M83513 / 14-G02NN	MK-3S2-051-445-000S-900	M83513 / 14-G03NN	MK-3S2-051-455-000S-900
M83513 / 14-G01NP	MK-3S2-051-435-220S-900	M83513 / 14-G02NP	MK-3S2-051-445-220S-900	M83513 / 14-G03NP	MK-3S2-051-455-220S-900
M83513 / 14-G01NT	MK-3S2-051-435-000S-0B7	M83513 / 14-G02NT	MK-3S2-051-445-000S-0B7	M83513 / 14-G03NT	MK-3S2-051-455-000S-0B7
M83513 / 14-G01NW	MK-3S2-051-435-220S-0B7	M83513 / 14-G02NW	MK-3S2-051-445-220S-0B7	M83513 / 14-G03NW	MK-3S2-051-455-220S-0B7
M83513 / 14-G01PN	MK-3S5-051-435-000S-900	M83513 / 14-G02PN	MK-3S5-051-445-000S-900	M83513 / 14-G03PN	MK-3S5-051-455-000S-900
M83513 / 14-G01PP	MK-3S5-051-435-220S-900	M83513 / 14-G02PP	MK-3S5-051-445-220S-900	M83513 / 14-G03PP	MK-3S5-051-455-220S-900
M83513 / 14-G01PT	MK-3S5-051-435-000S-0B7	M83513 / 14-G02PT	MK-3S5-051-445-000S-0B7	M83513 / 14-G03PT	MK-3S5-051-455-000S-0B7
M83513 / 14-G01PW	MK-3S5-051-435-220S-0B7	M83513 / 14-G02PW	MK-3S5-051-445-220S-0B7	M83513 / 14-G03PW	MK-3S5-051-455-220S-0B7

### M83513 / 15

M83513 / 15-H01CN	MK-4S3-100-435-000S-900	M83513 / 15-H02CN	MK-4S3-100-445-000S-900	M83513 / 15-H03CN	MK-4S3-100-455-000S-900
M83513 / 15-H01CP	MK-4S3-100-435-620S-900	M83513 / 15-H02CP	MK-4S3-100-445-620S-900	M83513 / 15-H03CP	MK-4S3-100-455-620S-900
M83513 / 15-H01CT	MK-4S3-100-435-000S-0B7	M83513 / 15-H02CT	MK-4S3-100-445-000S-0B7	M83513 / 15-H03CT	MK-4S3-100-455-000S-0B7
M83513 / 15-H01CW	MK-4S3-100-435-620S-0B7	M83513 / 15-H02CW	MK-4S3-100-445-620S-0B7	M83513 / 15-H03CW	MK-4S3-100-455-620S-0B7
M83513 / 15-H01NN	MK-4S2-100-435-000S-900	M83513 / 15-H02NN	MK-4S2-100-445-000S-900	M83513 / 15-H03NN	MK-4S2-100-455-000S-900
M83513 / 15-H01NP	MK-4S2-100-435-620S-900	M83513 / 15-H02NP	MK-4S2-100-445-620S-900	M83513 / 15-H03NP	MK-4S2-100-455-620S-900
M83513 / 15-H01NT	MK-4S2-100-435-000S-0B7	M83513 / 15-H02NT	MK-4S2-100-445-000S-0B7	M83513 / 15-H03NT	MK-4S2-100-455-000S-0B7
M83513 / 15-H01NW	MK-4S2-100-435-620S-0B7	M83513 / 15-H02NW	MK-4S2-100-445-620S-0B7	M83513 / 15-H03NW	MK-4S2-100-455-620S-0B7
M83513 / 15-H01PN	MK-4S5-100-435-000S-900	M83513 / 15-H02PN	MK-4S5-100-445-000S-900	M83513 / 15-H03PN	MK-4S5-100-455-000S-900
M83513 / 15-H01PP	MK-4S5-100-435-620S-900	M83513 / 15-H02PP	MK-4S5-100-445-620S-900	M83513 / 15-H03PP	MK-4S5-100-455-620S-900
M83513 / 15-H01PT	MK-4S5-100-435-000S-0B7	M83513 / 15-H02PT	MK-4S5-100-445-000S-0B7	M83513 / 15-H03PT	MK-4S5-100-455-000S-0B7
M83513 / 15-H01PW	MK-4S5-100-435-620S-0B7	M83513 / 15-H02PW	MK-4S5-100-445-620S-0B7	M83513 / 15-H03PW	MK-4S5-100-455-620S-0B7

### M83513 / 16

M83513 / 16-A01CN	MK-273-009-325-000R	M83513 / 16-A02NW	MK-272-009-335-220R-0B7	M83513 / 16-B01CN	MK-273-015-325-000R
M83513 / 16-A01CP	MK-273-009-325-220R	M83513 / 16-A02PN	MK-275-009-335-000R	M83513 / 16-B01CP	MK-273-015-325-220R
M83513 / 16-A01CT	MK-273-009-325-000R-0B7	M83513 / 16-A02PP	MK-275-009-335-220R	M83513 / 16-B01CT	MK-273-015-325-000R-0B7
M83513 / 16-A01CW	MK-273-009-325-220R-0B7	M83513 / 16-A02PT	MK-275-009-335-000R-0B7	M83513 / 16-B01CW	MK-273-015-325-220R-0B7
M83513 / 16-A01NN	MK-272-009-325-000R	M83513 / 16-A02PW	MK-275-009-335-220R-0B7	M83513 / 16-B01NN	MK-272-015-325-000R
M83513 / 16-A01NP	MK-272-009-325-220R	M83513 / 16-A03CN	MK-273-009-345-000R	M83513 / 16-B01NP	MK-272-015-325-220R
M83513 / 16-A01NT	MK-272-009-325-000R-0B7	M83513 / 16-A03CP	MK-273-009-345-220R	M83513 / 16-B01NT	MK-272-015-325-000R-0B7
M83513 / 16-A01NW	MK-272-009-325-220R-0B7	M83513 / 16-A03CT	MK-273-009-345-000R-0B7	M83513 / 16-B01NW	MK-272-015-325-220R-0B7
M83513 / 16-A01PN	MK-275-009-325-000R	M83513 / 16-A03CW	MK-273-009-345-220R-0B7	M83513 / 16-B01PN	MK-275-015-325-000R
M83513 / 16-A01PP	MK-275-009-325-220R	M83513 / 16-A03NN	MK-272-009-345-000R	M83513 / 16-B01PP	MK-275-015-325-220R
M83513 / 16-A01PT	MK-275-009-325-000R-0B7	M83513 / 16-A03NP	MK-272-009-345-220R	M83513 / 16-B01PT	MK-275-015-325-000R-0B7
M83513 / 16-A01PW	MK-275-009-325-220R-0B7	M83513 / 16-A03NT	MK-272-009-345-000R-0B7	M83513 / 16-B01PW	MK-275-015-325-220R-0B7
M83513 / 16-A02CN	MK-273-009-335-000R	M83513 / 16-A03NW	MK-272-009-345-220R-0B7	M83513 / 16-B02CN	MK-273-015-335-000R
M83513 / 16-A02CP	MK-273-009-335-220R	M83513 / 16-A03PN	MK-275-009-345-000R	M83513 / 16-B02CP	MK-273-015-335-220R
M83513 / 16-A02CT	MK-273-009-335-000R-0B7	M83513 / 16-A03PP	MK-275-009-345-220R	M83513 / 16-B02CT	MK-273-015-335-000R-0B7
M83513 / 16-A02CW	MK-273-009-335-220R-0B7	M83513 / 16-A03PT	MK-275-009-345-000R-0B7	M83513 / 16-B02CW	MK-273-015-335-220R-0B7
M83513 / 16-A02NN	MK-272-009-335-000R	M83513 / 16-A03PW	MK-275-009-345-220R-0B7	M83513 / 16-B02NN	MK-272-015-335-000R
M83513 / 16-A02NP	MK-272-009-335-220R			M83513 / 16-B02NP	MK-272-015-335-220R
M83513 / 16-A02NT	MK-272-009-335-000R-0B7			M83513 / 16-B02NT	MK-272-015-335-000R-0B7

## Military Cross Reference Chart

-- Continued from previous page

### M83513 / 16 (continued)

M83513 / 16-B02NW	MK-272-015-335-220R-OB7	M83513 / 16-D01CN	MK-273-025-325-000R	M83513 / 16-E02NW	MK-272-031-335-220R-OB7
M83513 / 16-B02PN	MK-275-015-335-000R	M83513 / 16-D01CP	MK-273-025-325-220R	M83513 / 16-E02PN	MK-275-031-335-000R
M83513 / 16-B02PP	MK-275-015-335-220R	M83513 / 16-D01CT	MK-273-025-325-000R-OB7	M83513 / 16-E02PP	MK-275-031-335-220R
M83513 / 16-B02PT	MK-275-015-335-000R-OB7	M83513 / 16-D01CW	MK-273-025-325-220R-OB7	M83513 / 16-E02PT	MK-275-031-335-000R-OB7
M83513 / 16-B02PW	MK-275-015-335-220R-OB7	M83513 / 16-D01NN	MK-272-025-325-000R	M83513 / 16-E02PW	MK-275-031-335-220R-OB7
M83513 / 16-B03CN	MK-273-015-345-000R	M83513 / 16-D01NP	MK-272-025-325-220R	M83513 / 16-E03CN	MK-273-031-345-000R
M83513 / 16-B03CP	MK-273-015-345-220R	M83513 / 16-D01NT	MK-272-025-325-000R-OB7	M83513 / 16-E03CP	MK-273-031-345-220R
M83513 / 16-B03CT	MK-273-015-345-000R-OB7	M83513 / 16-D01NW	MK-272-025-325-220R-OB7	M83513 / 16-E03CT	MK-273-031-345-000R-OB7
M83513 / 16-B03CW	MK-273-015-345-220R-OB7	M83513 / 16-D01PN	MK-275-025-325-000R	M83513 / 16-E03CW	MK-273-031-345-220R-OB7
M83513 / 16-B03NN	MK-272-015-345-000R	M83513 / 16-D01PP	MK-275-025-325-220R	M83513 / 16-E03NN	MK-272-031-345-000R
M83513 / 16-B03NP	MK-272-015-345-220R	M83513 / 16-D01PT	MK-275-025-325-000R-OB7	M83513 / 16-E03NP	MK-272-031-345-220R
M83513 / 16-B03NT	MK-272-015-345-000R-OB7	M83513 / 16-D01PW	MK-275-025-325-220R-OB7	M83513 / 16-E03NT	MK-272-031-345-000R-OB7
M83513 / 16-B03NW	MK-272-015-345-220R-OB7	M83513 / 16-D02CN	MK-273-025-335-000R	M83513 / 16-E03NW	MK-272-031-345-220R-OB7
M83513 / 16-B03PN	MK-275-015-345-000R	M83513 / 16-D02CP	MK-273-025-335-220R	M83513 / 16-E03PN	MK-275-031-345-000R
M83513 / 16-B03PP	MK-275-015-345-220R	M83513 / 16-D02CT	MK-273-025-335-000R-OB7	M83513 / 16-E03PP	MK-275-031-345-220R
M83513 / 16-B03PT	MK-275-015-345-000R-OB7	M83513 / 16-D02CW	MK-273-025-335-220R-OB7	M83513 / 16-E03PT	MK-275-031-345-000R-OB7
M83513 / 16-B03PW	MK-275-015-345-220R-OB7	M83513 / 16-D02NN	MK-272-025-335-000R	M83513 / 16-E03PW	MK-275-031-345-220R-OB7
M83513 / 16-C01CN	MK-273-021-325-000R	M83513 / 16-D02NP	MK-272-025-335-220R		
M83513 / 16-C01CP	MK-273-021-325-220R	M83513 / 16-D02NT	MK-272-025-335-000R-OB7	M83513 / 16-F01CN	MK-273-037-325-000R
M83513 / 16-C01CT	MK-273-021-325-000R-OB7	M83513 / 16-D02NW	MK-272-025-335-220R-OB7	M83513 / 16-F01CP	MK-273-037-325-220R
M83513 / 16-C01CW	MK-273-021-325-220R-OB7	M83513 / 16-D02PN	MK-275-025-335-000R	M83513 / 16-F01CT	MK-273-037-325-000R-OB7
M83513 / 16-C01NN	MK-272-021-325-000R	M83513 / 16-D02PP	MK-275-025-335-220R	M83513 / 16-F01CW	MK-273-037-325-220R-OB7
M83513 / 16-C01NP	MK-272-021-325-220R	M83513 / 16-D02PT	MK-275-025-335-000R-OB7	M83513 / 16-F01NN	MK-272-037-325-000R
M83513 / 16-C01NT	MK-272-021-325-000R-OB7	M83513 / 16-D02PW	MK-275-025-335-220R-OB7	M83513 / 16-F01NP	MK-272-037-325-220R
M83513 / 16-C01NW	MK-272-021-325-220R-OB7	M83513 / 16-D03CN	MK-273-025-345-000R	M83513 / 16-F01NT	MK-272-037-325-000R-OB7
M83513 / 16-C01PN	MK-275-021-325-000R	M83513 / 16-D03CP	MK-273-025-345-220R	M83513 / 16-F01NW	MK-272-037-325-220R-OB7
M83513 / 16-C01PP	MK-275-021-325-220R	M83513 / 16-D03CT	MK-273-025-345-000R-OB7	M83513 / 16-F01PN	MK-275-037-325-000R
M83513 / 16-C01PT	MK-275-021-325-000R-OB7	M83513 / 16-D03CW	MK-273-025-345-220R-OB7	M83513 / 16-F01PP	MK-275-037-325-220R
M83513 / 16-C01PW	MK-275-021-325-220R-OB7	M83513 / 16-D03NN	MK-272-025-345-000R	M83513 / 16-F01PT	MK-275-037-325-000R-OB7
M83513 / 16-C02CN	MK-273-021-335-000R	M83513 / 16-D03NP	MK-272-025-345-220R	M83513 / 16-F01PW	MK-275-037-325-220R-OB7
M83513 / 16-C02CP	MK-273-021-335-220R	M83513 / 16-D03NT	MK-272-025-345-000R-OB7	M83513 / 16-F02CN	MK-273-037-335-000R
M83513 / 16-C02CT	MK-273-021-335-000R-OB7	M83513 / 16-D03NW	MK-272-025-345-220R-OB7	M83513 / 16-F02CP	MK-273-037-335-220R
M83513 / 16-C02CW	MK-273-021-335-220R-OB7	M83513 / 16-D03PN	MK-275-025-345-000R	M83513 / 16-F02CT	MK-273-037-335-000R-OB7
M83513 / 16-C02NN	MK-272-021-335-000R	M83513 / 16-D03PP	MK-275-025-345-220R	M83513 / 16-F02CW	MK-273-037-335-220R-OB7
M83513 / 16-C02NP	MK-272-021-335-220R	M83513 / 16-D03PT	MK-275-025-345-000R-OB7	M83513 / 16-F02NN	MK-272-037-335-000R
M83513 / 16-C02NT	MK-272-021-335-000R-OB7	M83513 / 16-D03PW	MK-275-025-345-220R-OB7	M83513 / 16-F02NP	MK-272-037-335-220R
M83513 / 16-C02NW	MK-272-021-335-220R-OB7			M83513 / 16-F02NT	MK-272-037-335-000R-OB7
M83513 / 16-C02PN	MK-275-021-335-000R	M83513 / 16-E01CN	MK-273-031-325-000R	M83513 / 16-F02NW	MK-272-037-335-220R-OB7
M83513 / 16-C02PP	MK-275-021-335-220R	M83513 / 16-E01CP	MK-273-031-325-220R	M83513 / 16-F02PN	MK-275-037-335-000R
M83513 / 16-C02PT	MK-275-021-335-000R-OB7	M83513 / 16-E01CT	MK-273-031-325-000R-OB7	M83513 / 16-F02PP	MK-275-037-335-220R
M83513 / 16-C02PW	MK-275-021-335-220R-OB7	M83513 / 16-E01CW	MK-273-031-325-220R-OB7	M83513 / 16-F02PT	MK-275-037-335-000R-OB7
M83513 / 16-C03CN	MK-273-021-345-000R	M83513 / 16-E01NN	MK-272-031-325-000R	M83513 / 16-F02PW	MK-275-037-335-220R-OB7
M83513 / 16-C03CP	MK-273-021-345-220R	M83513 / 16-E01NP	MK-272-031-325-220R	M83513 / 16-F03CN	MK-273-037-345-000R
M83513 / 16-C03CT	MK-273-021-345-000R-OB7	M83513 / 16-E01NT	MK-272-031-325-000R-OB7	M83513 / 16-F03CP	MK-273-037-345-220R
M83513 / 16-C03CW	MK-273-021-345-220R-OB7	M83513 / 16-E01NW	MK-272-031-325-220R-OB7	M83513 / 16-F03CT	MK-273-037-345-000R-OB7
M83513 / 16-C03NN	MK-272-021-345-000R	M83513 / 16-E01PN	MK-275-031-325-000R	M83513 / 16-F03CW	MK-273-037-345-220R-OB7
M83513 / 16-C03NP	MK-272-021-345-220R	M83513 / 16-E01PP	MK-275-031-325-220R	M83513 / 16-F03NN	MK-272-037-345-000R
M83513 / 16-C03NT	MK-272-021-345-000R-OB7	M83513 / 16-E01PT	MK-275-031-325-000R-OB7	M83513 / 16-F03NP	MK-272-037-345-220R
M83513 / 16-C03NW	MK-272-021-345-220R-OB7	M83513 / 16-E01PW	MK-275-031-325-220R-OB7	M83513 / 16-F03NT	MK-272-037-345-000R-OB7
M83513 / 16-C03PN	MK-275-021-345-000R	M83513 / 16-E02CN	MK-273-031-335-000R	M83513 / 16-F03NW	MK-272-037-345-220R-OB7
M83513 / 16-C03PP	MK-275-021-345-220R	M83513 / 16-E02CP	MK-273-031-335-220R	M83513 / 16-F03PN	MK-275-037-345-000R
M83513 / 16-C03PT	MK-275-021-345-000R-OB7	M83513 / 16-E02CT	MK-273-031-335-000R-OB7	M83513 / 16-F03PP	MK-275-037-345-220R
M83513 / 16-C03PW	MK-275-021-345-220R-OB7	M83513 / 16-E02CW	MK-273-031-335-220R-OB7	M83513 / 16-F03PT	MK-275-037-345-000R-OB7
		M83513 / 16-E02NN	MK-272-031-335-000R	M83513 / 16-F03PW	MK-275-037-345-220R-OB7
		M83513 / 16-E02NP	MK-272-031-335-220R		
		M83513 / 16-E02NT	MK-272-031-335-000R-OB7		



## Military Cross Reference Chart

-- Continued from previous page

### M83513 / 17

M83513 / 17-G01CN	MK-373-051-325-000R	M83513 / 17-G02CN	MK-373-051-335-000R	M83513 / 17-G03CN	MK-373-051-345-000R
M83513 / 17-G01CP	MK-373-051-325-220R	M83513 / 17-G02CP	MK-373-051-335-220R	M83513 / 17-G03CP	MK-373-051-345-220R
M83513 / 17-G01CT	MK-373-051-325-000R-OB7	M83513 / 17-G02CT	MK-373-051-335-000R-OB7	M83513 / 17-G03CT	MK-373-051-345-000R-OB7
M83513 / 17-G01CW	MK-373-051-325-220R-OB7	M83513 / 17-G02CW	MK-373-051-335-220R-OB7	M83513 / 17-G03CW	MK-373-051-345-220R-OB7
M83513 / 17-G01NN	MK-372-051-325-000R	M83513 / 17-G02NN	MK-372-051-335-000R	M83513 / 17-G03NN	MK-372-051-345-000R
M83513 / 17-G01NP	MK-372-051-325-220R	M83513 / 17-G02NP	MK-372-051-335-220R	M83513 / 17-G03NP	MK-372-051-345-220R
M83513 / 17-G01NT	MK-372-051-325-000R-OB7	M83513 / 17-G02NT	MK-372-051-335-000R-OB7	M83513 / 17-G03NT	MK-372-051-345-000R-OB7
M83513 / 17-G01NW	MK-372-051-325-220R-OB7	M83513 / 17-G02NW	MK-372-051-335-220R-OB7	M83513 / 17-G03NW	MK-372-051-345-220R-OB7
M83513 / 17-G01PN	MK-375-051-325-000R	M83513 / 17-G02PN	MK-375-051-335-000R	M83513 / 17-G03PN	MK-375-051-345-000R
M83513 / 17-G01PP	MK-375-051-325-220R	M83513 / 17-G02PP	MK-375-051-335-220R	M83513 / 17-G03PP	MK-375-051-345-220R
M83513 / 17-G01PT	MK-375-051-325-000R-OB7	M83513 / 17-G02PT	MK-375-051-335-000R-OB7	M83513 / 17-G03PT	MK-375-051-345-000R-OB7
M83513 / 17-G01PW	MK-375-051-325-220R-OB7	M83513 / 17-G02PW	MK-375-051-335-220R-OB7	M83513 / 17-G03PW	MK-375-051-345-220R-OB7

### M83513 / 18

M83513 / 18-H01CN	MK-473-100-325-000R-05K	M83513 / 18-H02CN	MK-473-100-335-000R-05K	M83513 / 18-H03CN	MK-473-100-345-000R-05K
M83513 / 18-H01CP	MK-473-100-325-620R-05K	M83513 / 18-H02CP	MK-473-100-335-620R-05K	M83513 / 18-H03CP	MK-473-100-345-620R-05K
M83513 / 18-H01CT	MK-473-100-325-000R-0BJ	M83513 / 18-H02CT	MK-473-100-335-000R-0BJ	M83513 / 18-H03CT	MK-473-100-345-000R-0BJ
M83513 / 18-H01CW	MK-473-100-325-620R-0BJ	M83513 / 18-H02CW	MK-473-100-335-620R-0BJ	M83513 / 18-H03CW	MK-473-100-345-620R-0BJ
M83513 / 18-H01NN	MK-472-100-325-000R-05K	M83513 / 18-H02NN	MK-472-100-335-000R-05K	M83513 / 18-H03NN	MK-472-100-345-000R-05K
M83513 / 18-H01NP	MK-472-100-325-620R-05K	M83513 / 18-H02NP	MK-472-100-335-620R-05K	M83513 / 18-H03NP	MK-472-100-345-620R-05K
M83513 / 18-H01NT	MK-472-100-325-000R-0BJ	M83513 / 18-H02NT	MK-472-100-335-000R-0BJ	M83513 / 18-H03NT	MK-472-100-345-000R-0BJ
M83513 / 18-H01NW	MK-472-100-325-620R-0BJ	M83513 / 18-H02NW	MK-472-100-335-620R-0BJ	M83513 / 18-H03NW	MK-472-100-345-620R-0BJ
M83513 / 18-H01PN	MK-475-100-325-000R-05K	M83513 / 18-H02PN	MK-475-100-335-000R-05K	M83513 / 18-H03PN	MK-475-100-345-000R-05K
M83513 / 18-H01PP	MK-475-100-325-620R-05K	M83513 / 18-H02PP	MK-475-100-335-620R-05K	M83513 / 18-H03PP	MK-475-100-345-620R-05K
M83513 / 18-H01PT	MK-475-100-325-000R-0BJ	M83513 / 18-H02PT	MK-475-100-335-000R-0BJ	M83513 / 18-H03PT	MK-475-100-345-000R-0BJ
M83513 / 18-H01PW	MK-475-100-325-620R-0BJ	M83513 / 18-H02PW	MK-475-100-335-620R-0BJ	M83513 / 18-H03PW	MK-475-100-345-620R-0BJ

### M83513 / 19

M83513 / 19-A01CN	MK-283-009-435-000R-900	M83513 / 19-A03NN	MK-282-009-455-000R-900	M83513 / 19-B02NW	MK-282-015-445-220R-0B7
M83513 / 19-A01CP	MK-283-009-435-220R-900	M83513 / 19-A03NP	MK-282-009-455-220R-900	M83513 / 19-B02PN	MK-285-015-445-000R-900
M83513 / 19-A01CT	MK-283-009-435-000R-OB7	M83513 / 19-A03NT	MK-282-009-455-000R-OB7	M83513 / 19-B02PP	MK-285-015-445-220R-900
M83513 / 19-A01CW	MK-283-009-435-220R-OB7	M83513 / 19-A03NW	MK-282-009-455-220R-OB7	M83513 / 19-B02PT	MK-285-015-445-000R-OB7
M83513 / 19-A01NN	MK-282-009-435-000R-900	M83513 / 19-A03PN	MK-285-009-455-000R-900	M83513 / 19-B02PW	MK-285-015-445-220R-OB7
M83513 / 19-A01NP	MK-282-009-435-220R-900	M83513 / 19-A03PP	MK-285-009-455-220R-900	M83513 / 19-B03CN	MK-283-015-455-000R-900
M83513 / 19-A01NT	MK-282-009-435-000R-OB7	M83513 / 19-A03PT	MK-285-009-455-000R-OB7	M83513 / 19-B03CP	MK-283-015-455-220R-900
M83513 / 19-A01NW	MK-282-009-435-220R-OB7	M83513 / 19-A03PW	MK-285-009-455-220R-OB7	M83513 / 19-B03CT	MK-283-015-455-000R-OB7
M83513 / 19-A01PN	MK-285-009-435-000R-900	M83513 / 19-B01CN	MK-283-015-435-000R-900	M83513 / 19-B03CW	MK-283-015-455-220R-OB7
M83513 / 19-A01PP	MK-285-009-435-220R-900	M83513 / 19-B01CP	MK-283-015-435-220R-900	M83513 / 19-B03NN	MK-282-015-455-000R-900
M83513 / 19-A01PT	MK-285-009-435-000R-OB7	M83513 / 19-B01CT	MK-283-015-435-000R-OB7	M83513 / 19-B03NP	MK-282-015-455-220R-900
M83513 / 19-A01PW	MK-285-009-435-220R-OB7	M83513 / 19-B01CW	MK-283-015-435-220R-OB7	M83513 / 19-B03NT	MK-282-015-455-000R-OB7
M83513 / 19-A02CN	MK-283-009-445-000R-900	M83513 / 19-B01NN	MK-282-015-435-000R-900	M83513 / 19-B03NW	MK-282-015-455-220R-OB7
M83513 / 19-A02CP	MK-283-009-445-220R-900	M83513 / 19-B01NP	MK-282-015-435-220R-900	M83513 / 19-B03PN	MK-285-015-455-000R-900
M83513 / 19-A02CT	MK-283-009-445-000R-OB7	M83513 / 19-B01NT	MK-282-015-435-000R-OB7	M83513 / 19-B03PP	MK-285-015-455-220R-900
M83513 / 19-A02CW	MK-283-009-445-220R-OB7	M83513 / 19-B01NT	MK-282-015-435-000R-OB7	M83513 / 19-B03PT	MK-285-015-455-000R-OB7
M83513 / 19-A02NN	MK-282-009-445-000R-900	M83513 / 19-B01NW	MK-282-015-435-220R-OB7	M83513 / 19-B03PW	MK-285-015-455-220R-OB7
M83513 / 19-A02NP	MK-282-009-445-220R-900	M83513 / 19-B01PN	MK-285-015-435-000R-900	M83513 / 19-C01CN	MK-283-021-435-000R-900
M83513 / 19-A02NT	MK-282-009-445-000R-OB7	M83513 / 19-B01PP	MK-285-015-435-220R-900	M83513 / 19-C01CP	MK-283-021-435-220R-900
M83513 / 19-A02NW	MK-282-009-445-220R-OB7	M83513 / 19-B01PT	MK-285-015-435-000R-OB7	M83513 / 19-C01CT	MK-283-021-435-000R-OB7
M83513 / 19-A02PN	MK-285-009-445-000R-900	M83513 / 19-B01PW	MK-285-015-435-220R-OB7	M83513 / 19-C01CW	MK-283-021-435-220R-OB7
M83513 / 19-A02PP	MK-285-009-445-220R-900	M83513 / 19-B02CN	MK-283-015-445-000R-900	M83513 / 19-C01CN	MK-283-021-435-000R-900
M83513 / 19-A02PT	MK-285-009-445-000R-OB7	M83513 / 19-B02CP	MK-283-015-445-220R-900	M83513 / 19-C01NN	MK-282-021-435-000R-900
M83513 / 19-A02PW	MK-285-009-445-220R-OB7	M83513 / 19-B02CT	MK-283-015-445-000R-OB7	M83513 / 19-C01NP	MK-282-021-435-220R-900
M83513 / 19-A03CN	MK-283-009-455-000R-900	M83513 / 19-B02CW	MK-283-015-445-220R-OB7	M83513 / 19-C01NT	MK-282-021-435-000R-OB7
M83513 / 19-A03CP	MK-283-009-455-220R-900	M83513 / 19-B02NN	MK-282-015-445-000R-900	M83513 / 19-C01NW	MK-282-021-435-220R-OB7
M83513 / 19-A03CT	MK-283-009-455-000R-OB7	M83513 / 19-B02NP	MK-282-015-445-220R-900	M83513 / 19-C01PN	MK-285-021-435-000R-900
M83513 / 19-A03CW	MK-283-009-455-220R-OB7	M83513 / 19-B02NT	MK-282-015-445-000R-OB7	M83513 / 19-C01PP	MK-285-021-435-220R-900

## Military Cross Reference Chart

– Continued from previous page

### M83513 / 19 (continued)

M83513 / 19-C01PT	MK-285-021-435-000R-0B7	M83513 / 19-D02NW	MK-282-025-445-220R-0B7	M83513 / 19-E03NN	MK-282-031-455-000R-900
M83513 / 19-C01PW	MK-285-021-435-220R-0B7	M83513 / 19-D02PN	MK-285-025-445-000R-900	M83513 / 19-E03NP	MK-282-031-455-220R-900
M83513 / 19-C02CN	MK-283-021-445-000R-900	M83513 / 19-D02PP	MK-285-025-445-220R-900	M83513 / 19-E03NT	MK-282-031-455-000R-0B7
M83513 / 19-C02CP	MK-283-021-445-220R-900	M83513 / 19-D02PT	MK-285-025-445-000R-0B7	M83513 / 19-E03NW	MK-282-031-455-220R-0B7
M83513 / 19-C02CT	MK-283-021-445-000R-0B7	M83513 / 19-D02PW	MK-285-025-445-220R-0B7	M83513 / 19-E03PN	MK-285-031-455-000R-900
M83513 / 19-C02CW	MK-283-021-445-220R-0B7	M83513 / 19-D03CN	MK-283-025-455-000R-900	M83513 / 19-E03PP	MK-285-031-455-220R-900
M83513 / 19-C02NN	MK-282-021-445-000R-900	M83513 / 19-D03CP	MK-283-025-455-220R-900	M83513 / 19-E03PT	MK-285-031-455-000R-0B7
M83513 / 19-C02NP	MK-282-021-445-220R-900	M83513 / 19-D03CT	MK-283-025-455-000R-0B7	M83513 / 19-E03PW	MK-285-031-455-220R-0B7
M83513 / 19-C02NT	MK-282-021-445-000R-0B7	M83513 / 19-D03CW	MK-283-025-455-220R-0B7		
M83513 / 19-C02NW	MK-282-021-445-220R-0B7	M83513 / 19-D03NN	MK-282-025-455-000R-900	M83513 / 19-F01CN	MK-283-037-435-000R-900
M83513 / 19-C02PN	MK-285-021-445-000R-900	M83513 / 19-D03NP	MK-282-025-455-220R-900	M83513 / 19-F01CP	MK-283-037-435-220R-900
M83513 / 19-C02PP	MK-285-021-445-220R-900	M83513 / 19-D03NT	MK-282-025-455-000R-0B7	M83513 / 19-F01CT	MK-283-037-435-000R-0B7
M83513 / 19-C02PT	MK-285-021-445-000R-0B7	M83513 / 19-D03NW	MK-282-025-455-220R-0B7	M83513 / 19-F01CW	MK-283-037-435-220R-0B7
M83513 / 19-C02PW	MK-285-021-445-220R-0B7	M83513 / 19-D03PN	MK-285-025-455-000R-900	M83513 / 19-F01NN	MK-282-037-435-000R-900
M83513 / 19-C03CN	MK-283-021-455-000R-900	M83513 / 19-D03PP	MK-285-025-455-220R-900	M83513 / 19-F01NP	MK-282-037-435-220R-900
M83513 / 19-C03CP	MK-283-021-455-220R-900	M83513 / 19-D03PT	MK-285-025-455-000R-0B7	M83513 / 19-F01NT	MK-282-037-435-000R-0B7
M83513 / 19-C03CT	MK-283-021-455-000R-0B7	M83513 / 19-D03PW	MK-285-025-455-220R-0B7	M83513 / 19-F01NW	MK-282-037-435-220R-0B7
M83513 / 19-C03CW	MK-283-021-455-220R-0B7			M83513 / 19-F01PN	MK-285-037-435-000R-900
M83513 / 19-C03NN	MK-282-021-455-000R-900	M83513 / 19-E01CN	MK-283-031-435-000R-900	M83513 / 19-F01PP	MK-285-037-435-220R-900
M83513 / 19-C03NP	MK-282-021-455-220R-900	M83513 / 19-E01CP	MK-283-031-435-220R-900	M83513 / 19-F01PT	MK-285-037-435-000R-0B7
M83513 / 19-C03NT	MK-282-021-455-000R-0B7	M83513 / 19-E01CT	MK-283-031-435-000R-0B7	M83513 / 19-F01PW	MK-285-037-435-220R-0B7
M83513 / 19-C03NW	MK-282-021-455-220R-0B7	M83513 / 19-E01CW	MK-283-031-435-220R-0B7	M83513 / 19-F02CN	MK-283-037-445-000R-900
M83513 / 19-C03PN	MK-285-021-455-000R-900	M83513 / 19-E01NN	MK-282-031-435-000R-900	M83513 / 19-F02CP	MK-283-037-445-220R-900
M83513 / 19-C03PP	MK-285-021-455-220R-900	M83513 / 19-E01NP	MK-282-031-435-220R-900	M83513 / 19-F02CT	MK-283-037-445-000R-0B7
M83513 / 19-C03PT	MK-285-021-455-000R-0B7	M83513 / 19-E01NT	MK-282-031-435-000R-0B7	M83513 / 19-F02CW	MK-283-037-445-220R-0B7
M83513 / 19-C03PW	MK-285-021-455-220R-0B7	M83513 / 19-E01NW	MK-282-031-435-220R-0B7	M83513 / 19-F02NN	MK-282-037-445-000R-900
		M83513 / 19-E01PN	MK-285-031-435-000R-900	M83513 / 19-F02NP	MK-282-037-445-220R-900
M83513 / 19-D01CN	MK-283-025-435-000R-900	M83513 / 19-E01PP	MK-285-031-435-220R-900	M83513 / 19-F02NT	MK-282-037-445-000R-0B7
M83513 / 19-D01CP	MK-283-025-435-220R-900	M83513 / 19-E01PT	MK-285-031-435-000R-0B7	M83513 / 19-F02NW	MK-282-037-445-220R-0B7
M83513 / 19-D01CT	MK-283-025-435-000R-0B7	M83513 / 19-E01PW	MK-285-031-435-220R-0B7	M83513 / 19-F02PN	MK-285-037-445-000R-900
M83513 / 19-D01CW	MK-283-025-435-220R-0B7	M83513 / 19-E02CN	MK-283-031-445-000R-900	M83513 / 19-F02PP	MK-285-037-445-220R-900
M83513 / 19-D01NN	MK-282-025-435-000R-900	M83513 / 19-E02CP	MK-283-031-445-220R-900	M83513 / 19-F02PT	MK-285-037-445-000R-0B7
M83513 / 19-D01NP	MK-282-025-435-220R-900	M83513 / 19-E02CT	MK-283-031-445-000R-0B7	M83513 / 19-F02PW	MK-285-037-445-220R-0B7
M83513 / 19-D01NT	MK-282-025-435-000R-0B7	M83513 / 19-E02CW	MK-283-031-445-220R-0B7	M83513 / 19-F03CN	MK-283-037-455-000R-900
M83513 / 19-D01NW	MK-282-025-435-220R-0B7	M83513 / 19-E02NN	MK-282-031-445-000R-900	M83513 / 19-F03CP	MK-283-037-455-220R-900
M83513 / 19-D01PN	MK-285-025-435-000R-900	M83513 / 19-E02NP	MK-282-031-445-220R-900	M83513 / 19-F03CT	MK-283-037-455-000R-0B7
M83513 / 19-D01PP	MK-285-025-435-220R-900	M83513 / 19-E02NT	MK-282-031-445-000R-0B7	M83513 / 19-F03CW	MK-283-037-455-220R-0B7
M83513 / 19-D01PT	MK-285-025-435-000R-0B7	M83513 / 19-E02NW	MK-282-031-445-220R-0B7	M83513 / 19-F03NN	MK-282-037-455-000R-900
M83513 / 19-D01PW	MK-285-025-435-220R-0B7	M83513 / 19-E02PN	MK-285-031-445-000R-900	M83513 / 19-F03NP	MK-282-037-455-220R-900
M83513 / 19-D02CN	MK-283-025-445-000R-900	M83513 / 19-E02PP	MK-285-031-445-220R-900	M83513 / 19-F03NT	MK-282-037-455-000R-0B7
M83513 / 19-D02CP	MK-283-025-445-220R-900	M83513 / 19-E02PT	MK-285-031-445-000R-0B7	M83513 / 19-F03NW	MK-282-037-455-220R-0B7
M83513 / 19-D02CT	MK-283-025-445-000R-0B7	M83513 / 19-E02PW	MK-285-031-445-220R-0B7	M83513 / 19-F03PN	MK-285-037-455-000R-900
M83513 / 19-D02CW	MK-283-025-445-220R-0B7	M83513 / 19-E03CN	MK-283-031-455-000R-900	M83513 / 19-F03PP	MK-285-037-455-220R-900
M83513 / 19-D02NN	MK-282-025-445-000R-900	M83513 / 19-E03CP	MK-283-031-455-220R-900	M83513 / 19-F03PT	MK-285-037-455-000R-0B7
M83513 / 19-D02NP	MK-282-025-445-220R-900	M83513 / 19-E03CT	MK-283-031-455-000R-0B7	M83513 / 19-F03PW	MK-285-037-455-220R-0B7
M83513 / 19-D02NT	MK-282-025-445-000R-0B7	M83513 / 19-E03CW	MK-283-031-455-220R-0B7		

### M83513 / 20

M83513 / 20-G01CN	MK-383-051-435-000R-900	M83513 / 20-G01PN	MK-385-051-435-000R-900	M83513 / 20-G02NN	MK-382-051-445-000R-900
M83513 / 20-G01CP	MK-383-051-435-220R-900	M83513 / 20-G01PP	MK-385-051-435-220R-900	M83513 / 20-G02NP	MK-382-051-445-220R-900
M83513 / 20-G01CT	MK-383-051-435-000R-0B7	M83513 / 20-G01PT	MK-385-051-435-000R-0B7	M83513 / 20-G02NT	MK-382-051-445-000R-0B7
M83513 / 20-G01CW	MK-383-051-435-220R-0B7	M83513 / 20-G01PW	MK-385-051-435-220R-0B7	M83513 / 20-G02NW	MK-382-051-445-220R-0B7
M83513 / 20-G01NN	MK-382-051-435-000R-900	M83513 / 20-G02CN	MK-383-051-445-000R-900	M83513 / 20-G02PN	MK-385-051-445-000R-900
M83513 / 20-G01NP	MK-382-051-435-220R-900	M83513 / 20-G02CP	MK-383-051-445-220R-900	M83513 / 20-G02PP	MK-385-051-445-220R-900
M83513 / 20-G01NT	MK-382-051-435-000R-0B7	M83513 / 20-G02CT	MK-383-051-445-000R-0B7	M83513 / 20-G02PT	MK-385-051-445-000R-0B7
M83513 / 20-G01NW	MK-382-051-435-220R-0B7	M83513 / 20-G02CW	MK-383-051-445-220R-0B7	M83513 / 20-G02PW	MK-385-051-445-220R-0B7

## Military Cross Reference Chart

– Continued from previous page

### M83513 / 20 (continued)

M83513 / 20-G03CN	MK-383-051-455-000R-900	M83513 / 20-G03NN	MK-382-051-455-000R-900	M83513 / 20-G03PN	MK-385-051-455-000R-900
M83513 / 20-G03CP	MK-383-051-455-220R-900	M83513 / 20-G03NP	MK-382-051-455-220R-900	M83513 / 20-G03PP	MK-385-051-455-220R-900
M83513 / 20-G03CT	MK-383-051-455-000R-0B7	M83513 / 20-G03NT	MK-382-051-455-000R-0B7	M83513 / 20-G03PT	MK-385-051-455-000R-0B7
M83513 / 20-G03CW	MK-383-051-455-220R-0B7	M83513 / 20-G03NW	MK-382-051-455-220R-0B7	M83513 / 20-G03PW	MK-385-051-455-220R-0B7

### M83513 / 21

M83513 / 21-H01CN	MK-483-100-435-000R-05K	M83513 / 21-H02CN	MK-483-100-445-000R-05K	M83513 / 21-H03CN	MK-483-100-455-000R-05K
M83513 / 21-H01CP	MK-483-100-435-620R-05K	M83513 / 21-H02CP	MK-483-100-445-620R-05K	M83513 / 21-H03CP	MK-483-100-455-620R-05K
M83513 / 21-H01CT	MK-483-100-435-000R-0BJ	M83513 / 21-H02CT	MK-483-100-445-000R-0BJ	M83513 / 21-H03CT	MK-483-100-455-000R-0BJ
M83513 / 21-H01CW	MK-483-100-435-620R-0BJ	M83513 / 21-H02CW	MK-483-100-445-620R-0BJ	M83513 / 21-H03CW	MK-483-100-455-620R-0BJ
M83513 / 21-H01NN	MK-482-100-435-000R-05K	M83513 / 21-H02NN	MK-482-100-445-000R-05K	M83513 / 21-H03NN	MK-482-100-455-000R-05K
M83513 / 21-H01NP	MK-482-100-435-620R-05K	M83513 / 21-H02NP	MK-482-100-445-620R-05K	M83513 / 21-H03NP	MK-482-100-455-620R-05K
M83513 / 21-H01NT	MK-482-100-435-000R-0BJ	M83513 / 21-H02NT	MK-482-100-445-000R-0BJ	M83513 / 21-H03NT	MK-482-100-455-000R-0BJ
M83513 / 21-H01NW	MK-482-100-435-620R-0BJ	M83513 / 21-H02NW	MK-482-100-445-620R-0BJ	M83513 / 21-H03NW	MK-482-100-455-620R-0BJ
M83513 / 21-H01PN	MK-485-100-435-000R-05K	M83513 / 21-H02PN	MK-485-100-445-000R-05K	M83513 / 21-H03PN	MK-485-100-455-000R-05K
M83513 / 21-H01PP	MK-485-100-435-620R-05K	M83513 / 21-H02PP	MK-485-100-445-620R-05K	M83513 / 21-H03PP	MK-485-100-455-620R-05K
M83513 / 21-H01PT	MK-485-100-435-000R-0BJ	M83513 / 21-H02PT	MK-485-100-445-000R-0BJ	M83513 / 21-H03PT	MK-485-100-455-000R-0BJ
M83513 / 21-H01PW	MK-485-100-435-620R-0BJ	M83513 / 21-H02PW	MK-485-100-445-620R-0BJ	M83513 / 21-H03PW	MK-485-100-455-620R-0BJ

### M83513 / 22

M83513 / 22-A01CN	MK-213-009-125-0000	M83513 / 22-A03PW	MK-215-009-145-2200-0B7	M83513 / 22-B03PP	MK-215-015-145-2200
M83513 / 22-A01CP	MK-213-009-125-2200			M83513 / 22-B03PT	MK-215-015-145-0000-0B7
M83513 / 22-A01CT	MK-213-009-125-0000-0B7	M83513 / 22-B01CN	MK-213-015-125-0000	M83513 / 22-B03PW	MK-215-015-145-2200-0B7
M83513 / 22-A01CW	MK-213-009-125-2200-0B7	M83513 / 22-B01CP	MK-213-015-125-2200		
M83513 / 22-A01NN	MK-212-009-125-0000	M83513 / 22-B01CT	MK-213-015-125-0000-0B7	M83513 / 22-C01CN	MK-213-021-125-0000
M83513 / 22-A01NP	MK-212-009-125-2200	M83513 / 22-B01CW	MK-213-015-125-2200-0B7	M83513 / 22-C01CP	MK-213-021-125-2200
M83513 / 22-A01NT	MK-212-009-125-0000-0B7	M83513 / 22-B01NN	MK-212-015-125-0000	M83513 / 22-C01CT	MK-213-021-125-0000-0B7
M83513 / 22-A01NW	MK-212-009-125-2200-0B7	M83513 / 22-B01NP	MK-212-015-125-2200	M83513 / 22-C01CW	MK-213-021-125-2200-0B7
M83513 / 22-A01PN	MK-215-009-125-0000	M83513 / 22-B01NT	MK-212-015-125-0000-0B7	M83513 / 22-C01NN	MK-212-021-125-0000
M83513 / 22-A01PP	MK-215-009-125-2200	M83513 / 22-B01NW	MK-212-015-125-2200-0B7	M83513 / 22-C01NP	MK-212-021-125-2200
M83513 / 22-A01PT	MK-215-009-125-0000-0B7	M83513 / 22-B01PN	MK-215-015-125-0000	M83513 / 22-C01NT	MK-212-021-125-0000-0B7
M83513 / 22-A01PW	MK-215-009-125-2200-0B7	M83513 / 22-B01PP	MK-215-015-125-2200	M83513 / 22-C01NW	MK-212-021-125-2200-0B7
M83513 / 22-A02CN	MK-213-009-135-0000	M83513 / 22-B01PT	MK-215-015-125-0000-0B7	M83513 / 22-C01PN	MK-215-021-125-0000
M83513 / 22-A02CP	MK-213-009-135-2200	M83513 / 22-B01PW	MK-215-015-125-2200-0B7	M83513 / 22-C01PP	MK-215-021-125-2200
M83513 / 22-A02CT	MK-213-009-135-0000-0B7	M83513 / 22-B02CN	MK-213-015-135-0000	M83513 / 22-C01PT	MK-215-021-125-0000-0B7
M83513 / 22-A02CW	MK-213-009-135-2200-0B7	M83513 / 22-B02CP	MK-213-015-135-2200	M83513 / 22-C01PW	MK-215-021-125-2200-0B7
M83513 / 22-A02NN	MK-212-009-135-0000	M83513 / 22-B02CT	MK-213-015-135-0000-0B7	M83513 / 22-C02CN	MK-213-021-135-0000
M83513 / 22-A02NP	MK-212-009-135-2200	M83513 / 22-B02CW	MK-213-015-135-2200-0B7	M83513 / 22-C02CP	MK-213-021-135-2200
M83513 / 22-A02NT	MK-212-009-135-0000-0B7	M83513 / 22-B02NN	MK-212-015-135-0000	M83513 / 22-C02CT	MK-213-021-135-0000-0B7
M83513 / 22-A02NW	MK-212-009-135-2200-0B7	M83513 / 22-B02NP	MK-212-015-135-2200	M83513 / 22-C02CW	MK-213-021-135-2200-0B7
M83513 / 22-A02PN	MK-215-009-135-0000	M83513 / 22-B02NT	MK-212-015-135-0000-0B7	M83513 / 22-C02NN	MK-212-021-135-0000
M83513 / 22-A02PP	MK-215-009-135-2200	M83513 / 22-B02NW	MK-212-015-135-2200-0B7	M83513 / 22-C02NP	MK-212-021-135-2200
M83513 / 22-A02PT	MK-215-009-135-0000-0B7	M83513 / 22-B02PN	MK-215-015-135-0000	M83513 / 22-C02NT	MK-212-021-135-0000-0B7
M83513 / 22-A02PW	MK-215-009-135-2200-0B7	M83513 / 22-B02PP	MK-215-015-135-2200	M83513 / 22-C02NW	MK-212-021-135-2200-0B7
M83513 / 22-A03CN	MK-213-009-145-0000	M83513 / 22-B02PT	MK-215-015-135-0000-0B7	M83513 / 22-C02PN	MK-215-021-135-0000
M83513 / 22-A03CP	MK-213-009-145-2200	M83513 / 22-B02PW	MK-215-015-135-2200-0B7	M83513 / 22-C02PP	MK-215-021-135-2200
M83513 / 22-A03CT	MK-213-009-145-0000-0B7	M83513 / 22-B03CN	MK-213-015-145-0000	M83513 / 22-C02PT	MK-215-021-135-0000-0B7
M83513 / 22-A03CW	MK-213-009-145-2200-0B7	M83513 / 22-B03CP	MK-213-015-145-2200	M83513 / 22-C02PW	MK-215-021-135-2200-0B7
M83513 / 22-A03NN	MK-212-009-145-0000	M83513 / 22-B03CT	MK-213-015-145-0000-0B7	M83513 / 22-C03CN	MK-213-021-145-0000
M83513 / 22-A03NP	MK-212-009-145-2200	M83513 / 22-B03CW	MK-213-015-145-2200-0B7	M83513 / 22-C03CP	MK-213-021-145-2200
M83513 / 22-A03NT	MK-212-009-145-0000-0B7	M83513 / 22-B03NN	MK-212-015-145-0000	M83513 / 22-C03CT	MK-213-021-145-0000-0B7
M83513 / 22-A03NW	MK-212-009-145-2200-0B7	M83513 / 22-B03NP	MK-212-015-145-2200	M83513 / 22-C03CW	MK-213-021-145-2200-0B7
M83513 / 22-A03PN	MK-215-009-145-0000	M83513 / 22-B03NT	MK-212-015-145-0000-0B7	M83513 / 22-C03NN	MK-212-021-145-0000
M83513 / 22-A03PP	MK-215-009-145-2200	M83513 / 22-B03NW	MK-212-015-145-2200-0B7	M83513 / 22-C03NP	MK-212-021-145-2200
M83513 / 22-A03PT	MK-215-009-145-0000-0B7	M83513 / 22-B03PN	MK-215-015-145-0000	M83513 / 22-C03NT	MK-212-021-145-0000-0B7

## Military Cross Reference Chart

– Continued from previous page

### M83513 / 22 (continued)

M83513 / 22-C03NW	MK-212-021-145-2200-0B7	M83513 / 22-D03PP	MK-215-025-145-2200	M83513 / 22-E03PW	MK-215-031-145-2200-0B7
M83513 / 22-C03PN	MK-215-021-145-0000	M83513 / 22-D03PT	MK-215-025-145-0000-0B7		
M83513 / 22-C03PP	MK-215-021-145-2200	M83513 / 22-D03PW	MK-215-025-145-2200-0B7		
M83513 / 22-C03PT	MK-215-021-145-0000-0B7				
M83513 / 22-C03PW	MK-215-021-145-2200-0B7				
<hr/>					
M83513 / 22-D01CN	MK-213-025-125-0000	M83513 / 22-E01CN	MK-213-031-125-0000		
M83513 / 22-D01CP	MK-213-025-125-2200	M83513 / 22-E01CP	MK-213-031-125-2200		
M83513 / 22-D01CT	MK-213-025-125-0000-0B7	M83513 / 22-E01CT	MK-213-031-125-0000-0B7		
M83513 / 22-D01CW	MK-213-025-125-2200-0B7	M83513 / 22-E01CW	MK-213-031-125-2200-0B7		
M83513 / 22-D01NN	MK-212-025-125-0000	M83513 / 22-E01NN	MK-212-031-125-0000		
M83513 / 22-D01NP	MK-212-025-125-2200	M83513 / 22-E01NP	MK-212-031-125-2200		
M83513 / 22-D01NT	MK-212-025-125-0000-0B7	M83513 / 22-E01NT	MK-212-031-125-0000-0B7		
M83513 / 22-D01NW	MK-212-025-125-2200-0B7	M83513 / 22-E01NW	MK-212-031-125-2200-0B7		
M83513 / 22-D01PN	MK-215-025-125-0000	M83513 / 22-E01PN	MK-215-031-125-0000		
M83513 / 22-D01PP	MK-215-025-125-2200	M83513 / 22-E01PP	MK-215-031-125-2200		
M83513 / 22-D01PT	MK-215-025-125-0000-0B7	M83513 / 22-E01PT	MK-215-031-125-0000-0B7		
M83513 / 22-D01PW	MK-215-025-125-2200-0B7	M83513 / 22-E01PW	MK-215-031-125-2200-0B7		
M83513 / 22-D02CN	MK-213-025-135-0000	M83513 / 22-E02CN	MK-213-031-135-0000		
M83513 / 22-D02CP	MK-213-025-135-2200	M83513 / 22-E02CP	MK-213-031-135-2200		
M83513 / 22-D02CT	MK-213-025-135-0000-0B7	M83513 / 22-E02CT	MK-213-031-135-0000-0B7		
M83513 / 22-D02CW	MK-213-025-135-2200-0B7	M83513 / 22-E02CW	MK-213-031-135-2200-0B7		
M83513 / 22-D02NN	MK-212-025-135-0000	M83513 / 22-E02NN	MK-212-031-135-0000		
M83513 / 22-D02NP	MK-212-025-135-2200	M83513 / 22-E02NP	MK-212-031-135-2200		
M83513 / 22-D02NT	MK-212-025-135-0000-0B7	M83513 / 22-E02NT	MK-212-031-135-0000-0B7		
M83513 / 22-D02NW	MK-212-025-135-2200-0B7	M83513 / 22-E02NW	MK-212-031-135-2200-0B7		
M83513 / 22-D02PN	MK-215-025-135-0000	M83513 / 22-E02PN	MK-215-031-135-0000		
M83513 / 22-D02PP	MK-215-025-135-2200	M83513 / 22-E02PP	MK-215-031-135-0000-0B7		
M83513 / 22-D02PT	MK-215-025-135-0000-0B7	M83513 / 22-E02PW	MK-215-031-135-2200-0B7		
M83513 / 22-D02PW	MK-215-025-135-2200-0B7	M83513 / 22-E03CN	MK-213-031-145-0000		
M83513 / 22-D03CN	MK-213-025-145-0000	M83513 / 22-E03CP	MK-213-031-145-2200		
M83513 / 22-D03CP	MK-213-025-145-2200	M83513 / 22-E03CT	MK-213-031-145-0000-0B7		
M83513 / 22-D03CT	MK-213-025-145-0000-0B7	M83513 / 22-E03CW	MK-213-031-145-2200-0B7		
M83513 / 22-D03CW	MK-213-025-145-2200-0B7	M83513 / 22-E03NN	MK-212-031-145-0000		
M83513 / 22-D03NN	MK-212-025-145-0000	M83513 / 22-E03NP	MK-212-031-145-2200		
M83513 / 22-D03NP	MK-212-025-145-2200	M83513 / 22-E03NT	MK-212-031-145-0000-0B7		
M83513 / 22-D03NT	MK-212-025-145-0000-0B7	M83513 / 22-E03NW	MK-212-031-145-2200-0B7		
M83513 / 22-D03NW	MK-212-025-145-2200-0B7	M83513 / 22-E03PN	MK-215-031-145-0000		
M83513 / 22-D03PN	MK-215-025-145-0000	M83513 / 22-E03PP	MK-215-031-145-2200		
		M83513 / 22-E03PT	MK-215-031-145-0000-0B7		

### M83513 / 23

M83513 / 23-G01CN	MK-313-051-125-0000	M83513 / 23-G02CN	MK-313-051-135-0000	M83513 / 23-G03CN	MK-313-051-145-0000
M83513 / 23-G01CP	MK-313-051-125-2200	M83513 / 23-G02CP	MK-313-051-135-2200	M83513 / 23-G03CP	MK-313-051-145-2200
M83513 / 23-G01CT	MK-313-051-125-0000-0B7	M83513 / 23-G02CT	MK-313-051-135-0000-0B7	M83513 / 23-G03CT	MK-313-051-145-0000-0B7
M83513 / 23-G01CW	MK-313-051-125-2200-0B7	M83513 / 23-G02CW	MK-313-051-135-2200-0B7	M83513 / 23-G03CW	MK-313-051-145-2200-0B7
M83513 / 23-G01NN	MK-312-051-125-0000	M83513 / 23-G02NN	MK-312-051-135-0000	M83513 / 23-G03NN	MK-312-051-145-0000
M83513 / 23-G01NP	MK-312-051-125-2200	M83513 / 23-G02NP	MK-312-051-135-2200	M83513 / 23-G03NP	MK-312-051-145-2200
M83513 / 23-G01NT	MK-312-051-125-0000-0B7	M83513 / 23-G02NT	MK-312-051-135-0000-0B7	M83513 / 23-G03NT	MK-312-051-145-0000-0B7
M83513 / 23-G01NW	MK-312-051-125-2200-0B7	M83513 / 23-G02NW	MK-312-051-135-2200-0B7	M83513 / 23-G03NW	MK-312-051-145-2200-0B7
M83513 / 23-G01PN	MK-315-051-125-0000	M83513 / 23-G02PN	MK-315-051-135-0000	M83513 / 23-G03PN	MK-315-051-145-0000
M83513 / 23-G01PP	MK-315-051-125-2200	M83513 / 23-G02PP	MK-315-051-135-2200	M83513 / 23-G03PP	MK-315-051-145-2200
M83513 / 23-G01PT	MK-315-051-125-0000-0B7	M83513 / 23-G02PT	MK-315-051-135-0000-0B7	M83513 / 23-G03PT	MK-315-051-145-0000-0B7
M83513 / 23-G01PW	MK-315-051-125-2200-0B7	M83513 / 23-G02PW	MK-315-051-135-2200-0B7	M83513 / 23-G03PW	MK-315-051-145-2200-0B7



## Military Cross Reference Chart

-- Continued from previous page

### M83513 / 25 (continued)

M83513 / 25-D02CN	MK-223-025-235-0000-900	M83513 / 25-E01PN	MK-225-031-225-0000-900	M83513 / 25-F01NN	MK-222-037-225-0000-900
M83513 / 25-D02CP	MK-223-025-235-2200-900	M83513 / 25-E01PP	MK-225-031-225-2200-900	M83513 / 25-F01NP	MK-222-037-225-2200-900
M83513 / 25-D02CT	MK-223-025-235-0000-0B7	M83513 / 25-E01PT	MK-225-031-225-0000-0B7	M83513 / 25-F01NT	MK-222-037-225-0000-0B7
M83513 / 25-D02CW	MK-223-025-235-2200-0B7	M83513 / 25-E01PW	MK-225-031-225-2200-0B7	M83513 / 25-F01NW	MK-222-037-225-2200-0B7
M83513 / 25-D02NN	MK-222-025-235-0000-900	M83513 / 25-E02CN	MK-223-031-235-0000-900	M83513 / 25-F01PN	MK-225-037-225-0000-900
M83513 / 25-D02NP	MK-222-025-235-2200-900	M83513 / 25-E02CP	MK-223-031-235-2200-900	M83513 / 25-F01PP	MK-225-037-225-2200-900
M83513 / 25-D02NT	MK-222-025-235-0000-0B7	M83513 / 25-E02CT	MK-223-031-235-0000-0B7	M83513 / 25-F01PT	MK-225-037-225-0000-0B7
M83513 / 25-D02NV	MK-222-025-235-2200-0B7	M83513 / 25-E02CW	MK-223-031-235-2200-0B7	M83513 / 25-F01PW	MK-225-037-225-2200-0B7
M83513 / 25-D02PN	MK-225-025-235-0000-900	M83513 / 25-E02NN	MK-222-031-235-0000-900	M83513 / 25-F02CN	MK-223-037-235-0000-900
M83513 / 25-D02PP	MK-223-025-235-2200-900	M83513 / 25-E02NP	MK-222-031-235-2200-900	M83513 / 25-F02CP	MK-225-037-235-2200-900
M83513 / 25-D02PT	MK-225-025-235-0000-0B7	M83513 / 25-E02NT	MK-222-031-235-0000-0B7	M83513 / 25-F02CT	MK-223-037-235-0000-0B7
M83513 / 25-D02PW	MK-225-025-235-2200-0B7	M83513 / 25-E02NW	MK-222-031-235-2200-0B7	M83513 / 25-F02CW	MK-223-037-235-2200-0B7
M83513 / 25-D03CN	MK-223-025-245-0000-900	M83513 / 25-E02PN	MK-225-031-235-0000-900	M83513 / 25-F02NN	MK-222-037-235-0000-900
M83513 / 25-D03CP	MK-223-025-245-2200-900	M83513 / 25-E02PP	MK-225-031-235-2200-900	M83513 / 25-F02NP	MK-222-037-235-2200-900
M83513 / 25-D03CT	MK-223-025-245-0000-0B7	M83513 / 25-E02PT	MK-225-031-235-0000-0B7	M83513 / 25-F02NT	MK-222-037-235-0000-0B7
M83513 / 25-D03CW	MK-223-025-245-2200-0B7	M83513 / 25-E02PW	MK-225-031-235-2200-0B7	M83513 / 25-F02NW	MK-222-037-235-2200-0B7
M83513 / 25-D03NN	MK-222-025-245-0000-900	M83513 / 25-E03CN	MK-223-031-245-0000-900	M83513 / 25-F02PN	MK-225-037-235-0000-900
M83513 / 25-D03NP	MK-222-025-245-2200-900	M83513 / 25-E03CP	MK-223-031-245-2200-900	M83513 / 25-F02PP	MK-222-037-235-2200-900
M83513 / 25-D03NT	MK-222-025-245-0000-0B7	M83513 / 25-E03CT	MK-223-031-245-0000-0B7	M83513 / 25-F02PT	MK-225-037-235-0000-0B7
M83513 / 25-D03NW	MK-222-025-245-2200-0B7	M83513 / 25-E03CW	MK-223-031-245-2200-0B7	M83513 / 25-F02PW	MK-225-037-235-2200-0B7
M83513 / 25-D03PN	MK-225-025-245-0000-900	M83513 / 25-E03NN	MK-222-031-245-0000-900	M83513 / 25-F03CN	MK-223-037-245-0000-900
M83513 / 25-D03PP	MK-225-025-245-2200-900	M83513 / 25-E03NP	MK-222-031-245-2200-900	M83513 / 25-F03CP	MK-223-037-245-2200-900
M83513 / 25-D03PT	MK-225-025-245-0000-0B7	M83513 / 25-E03NT	MK-222-031-245-0000-0B7	M83513 / 25-F03CT	MK-223-037-245-0000-0B7
M83513 / 25-D03PW	MK-225-025-245-2200-0B7	M83513 / 25-E03NW	MK-222-031-245-2200-0B7	M83513 / 25-F03CW	MK-223-037-245-2200-0B7
<hr/>					
M83513 / 25-E01CN	MK-223-031-225-0000-900	M83513 / 25-E03PN	MK-225-031-245-0000-900	M83513 / 25-F03NN	MK-222-037-245-0000-900
M83513 / 25-E01CP	MK-223-031-225-2200-900	M83513 / 25-E03PP	MK-225-031-245-2200-900	M83513 / 25-F03NP	MK-222-037-245-2200-900
M83513 / 25-E01CT	MK-223-031-225-0000-0B7	M83513 / 25-E03PT	MK-225-031-245-0000-0B7	M83513 / 25-F03NT	MK-222-037-245-0000-0B7
M83513 / 25-E01CW	MK-223-031-225-2200-0B7	M83513 / 25-E03PW	MK-225-031-245-2200-0B7	M83513 / 25-F03NW	MK-222-037-245-2200-0B7
M83513 / 25-E01NN	MK-222-031-225-0000-900	M83513 / 25-F01CN	MK-223-037-225-0000-900	M83513 / 25-F03PN	MK-225-037-245-0000-900
M83513 / 25-E01NP	MK-222-031-225-2200-900	M83513 / 25-F01CP	MK-223-037-225-2200-900	M83513 / 25-F03PP	MK-225-037-245-2200-900
M83513 / 25-E01NT	MK-222-031-225-0000-0B7	M83513 / 25-F01CT	MK-223-037-225-0000-0B7	M83513 / 25-F03PT	MK-225-037-245-0000-0B7
M83513 / 25-E01NW	MK-222-031-225-2200-0B7	M83513 / 25-F01CW	MK-223-037-225-2200-0B7	M83513 / 25-F03PW	MK-225-037-245-2200-0B7

### M83513 / 26

M83513 / 26-G01CN	MK-323-051-225-0000-900	M83513 / 26-G02CN	MK-323-051-235-0000-900	M83513 / 26-G03CN	MK-323-051-245-0000-900
M83513 / 26-G01CP	MK-323-051-225-2200-900	M83513 / 26-G02CP	MK-323-051-235-2200-900	M83513 / 26-G03CP	MK-323-051-245-2200-900
M83513 / 26-G01CT	MK-323-051-225-0000-0B7	M83513 / 26-G02CT	MK-323-051-235-0000-0B7	M83513 / 26-G03CT	MK-323-051-245-0000-0B7
M83513 / 26-G01CW	MK-323-051-225-2200-0B7	M83513 / 26-G02CW	MK-323-051-235-2200-0B7	M83513 / 26-G03CW	MK-323-051-245-2200-0B7
M83513 / 26-G01NN	MK-322-051-225-0000-900	M83513 / 26-G02NN	MK-322-051-235-0000-900	M83513 / 26-G03NN	MK-322-051-245-0000-900
M83513 / 26-G01NP	MK-322-051-225-2200-900	M83513 / 26-G02NP	MK-322-051-235-2200-900	M83513 / 26-G03NP	MK-322-051-245-2200-900
M83513 / 26-G01NT	MK-322-051-225-0000-0B7	M83513 / 26-G02NT	MK-322-051-235-0000-0B7	M83513 / 26-G03NT	MK-322-051-245-0000-0B7
M83513 / 26-G01NW	MK-322-051-225-2200-0B7	M83513 / 26-G02NW	MK-322-051-235-2200-0B7	M83513 / 26-G03NW	MK-322-051-245-2200-0B7
M83513 / 26-G01PN	MK-325-051-225-0000-900	M83513 / 26-G02PN	MK-325-051-235-0000-900	M83513 / 26-G03PN	MK-325-051-245-0000-900
M83513 / 26-G01PP	MK-325-051-225-2200-900	M83513 / 26-G02PP	MK-325-051-235-2200-900	M83513 / 26-G03PP	MK-325-051-245-2200-900
M83513 / 26-G01PT	MK-325-051-225-0000-0B7	M83513 / 26-G02PT	MK-325-051-235-0000-0B7	M83513 / 26-G03PT	MK-325-051-245-0000-0B7
M83513 / 26-G01PW	MK-325-051-225-2200-0B7	M83513 / 26-G02PW	MK-325-051-235-2200-0B7	M83513 / 26-G03PW	MK-325-051-245-2200-0B7

### M83513 / 27

M83513 / 27-H01CN	MK-423-100-225-0000-900	M83513 / 27-H01NT	MK-422-100-225-0000-0B7	M83513 / 27-H02CN	MK-423-100-235-0000-900
M83513 / 27-H01CP	MK-423-100-225-6200-900	M83513 / 27-H01NW	MK-422-100-225-6200-0B7	M83513 / 27-H02CP	MK-423-100-235-6200-900
M83513 / 27-H01CT	MK-423-100-225-0000-0B7	M83513 / 27-H01PN	MK-425-100-225-0000-900	M83513 / 27-H02CT	MK-423-100-235-0000-0B7
M83513 / 27-H01CW	MK-423-100-225-6200-0B7	M83513 / 27-H01PP	MK-425-100-225-6200-900	M83513 / 27-H02CW	MK-423-100-235-6200-0B7
M83513 / 27-H01NN	MK-422-100-225-0000-900	M83513 / 27-H01PT	MK-425-100-225-0000-0B7	M83513 / 27-H02NN	MK-422-100-235-0000-900
M83513 / 27-H01NP	MK-422-100-225-6200-900	M83513 / 27-H01PW	MK-425-100-225-6200-0B7	M83513 / 27-H02NP	MK-422-100-235-6200-900



# Military Cross Reference Chart

-- Continued from previous page

## M83513 / 27 (continued)

M83513 / 27-H02NT	MK-422-100-235-0000-0B7	M83513 / 27-H03CN	MK-423-100-245-0000-900	M83513 / 27-H03NT	MK-422-100-245-0000-0B7
M83513 / 27-H02NW	MK-422-100-235-6200-0B7	M83513 / 27-H03CP	MK-423-100-245-6200-900	M83513 / 27-H03NW	MK-422-100-245-6200-0B7
M83513 / 27-H02PN	MK-425-100-235-0000-900	M83513 / 27-H03CT	MK-423-100-245-0000-0B7	M83513 / 27-H03PN	MK-425-100-245-0000-900
M83513 / 27-H02PP	MK-425-100-235-6200-900	M83513 / 27-H03CW	MK-423-100-245-6200-0B7	M83513 / 27-H03PP	MK-425-100-245-6200-900
M83513 / 27-H02PT	MK-425-100-235-0000-0B7	M83513 / 27-H03NN	MK-422-100-245-0000-900	M83513 / 27-H03PT	MK-425-100-245-0000-0B7
M83513 / 27-H02PW	MK-425-100-235-6200-0B7	M83513 / 27-H03NP	MK-422-100-245-6200-900	M83513 / 27-H03PW	MK-425-100-245-6200-0B7

## M83513 / 28

M83513 / 28-A01CN	MK-233-009-125-0000	M83513 / 28-B01PT	MK-235-015-125-0000-0B7	M83513 / 28-C02PN	MK-235-021-135-0000
M83513 / 28-A01CP	MK-233-009-125-2200	M83513 / 28-B01PW	MK-235-015-125-2200-0B7	M83513 / 28-C02PP	MK-235-021-135-2200
M83513 / 28-A01CT	MK-233-009-125-0000-0B7	M83513 / 28-B02CN	MK-233-015-135-0000	M83513 / 28-C02PT	MK-235-021-135-0000-0B7
M83513 / 28-A01CW	MK-233-009-125-2200-0B7	M83513 / 28-B02CP	MK-233-015-135-2200	M83513 / 28-C02PW	MK-235-021-135-2200-0B7
M83513 / 28-A01NN	MK-232-009-125-0000	M83513 / 28-B02CT	MK-233-015-135-0000-0B7	M83513 / 28-C03CN	MK-233-021-145-0000
M83513 / 28-A01NP	MK-232-009-125-2200	M83513 / 28-B02CW	MK-233-015-135-2200-0B7	M83513 / 28-C03CP	MK-233-021-145-2200
M83513 / 28-A01NT	MK-232-009-125-0000-0B7	M83513 / 28-B02NN	MK-232-015-135-0000	M83513 / 28-C03CT	MK-233-021-145-0000-0B7
M83513 / 28-A01NW	MK-232-009-125-2200-0B7	M83513 / 28-B02NP	MK-232-015-135-2200	M83513 / 28-C03CW	MK-233-021-145-2200-0B7
M83513 / 28-A01PN	MK-235-009-125-0000	M83513 / 28-B02NT	MK-232-015-135-0000-0B7	M83513 / 28-C03NN	MK-232-021-145-0000
M83513 / 28-A01PP	MK-235-009-125-2200	M83513 / 28-B02NW	MK-232-015-135-2200-0B7	M83513 / 28-C03NP	MK-232-021-145-2200
M83513 / 28-A01PT	MK-235-009-125-0000-0B7	M83513 / 28-B02PN	MK-235-015-135-0000	M83513 / 28-C03NT	MK-232-021-145-0000-0B7
M83513 / 28-A01PW	MK-235-009-125-2200-0B7	M83513 / 28-B02PP	MK-235-015-135-2200	M83513 / 28-C03NW	MK-232-021-145-2200-0B7
M83513 / 28-A02CN	MK-233-009-135-0000	M83513 / 28-B02PT	MK-235-015-135-0000-0B7	M83513 / 28-C03PN	MK-235-021-145-0000
M83513 / 28-A02CP	MK-233-009-135-2200	M83513 / 28-B02PW	MK-235-015-135-2200-0B7	M83513 / 28-C03PP	MK-235-021-145-2200
M83513 / 28-A02CT	MK-233-009-135-0000-0B7	M83513 / 28-B03CN	MK-233-015-145-0000	M83513 / 28-C03PT	MK-235-021-145-0000-0B7
M83513 / 28-A02CW	MK-233-009-135-2200-0B7	M83513 / 28-B03CP	MK-233-015-145-2200	M83513 / 28-C03PW	MK-235-021-145-2200-0B7
M83513 / 28-A02NN	MK-232-009-135-0000	M83513 / 28-B03CT	MK-233-015-145-0000-0B7		
M83513 / 28-A02NP	MK-232-009-135-2200	M83513 / 28-B03CW	MK-233-015-145-2200-0B7	M83513 / 28-D01CN	MK-233-025-125-0000
M83513 / 28-A02NT	MK-232-009-135-0000-0B7	M83513 / 28-B03NN	MK-232-015-145-0000	M83513 / 28-D01CP	MK-233-025-125-2200
M83513 / 28-A02NW	MK-232-009-135-2200-0B7	M83513 / 28-B03NP	MK-232-015-145-2200	M83513 / 28-D01CT	MK-233-025-125-0000-0B7
M83513 / 28-A02PN	MK-235-009-135-0000	M83513 / 28-B03NT	MK-232-015-145-0000-0B7	M83513 / 28-D01CW	MK-233-025-125-2200-0B7
M83513 / 28-A02PP	MK-235-009-135-2200	M83513 / 28-B03NW	MK-232-015-145-2200-0B7	M83513 / 28-D01NN	MK-232-025-125-0000
M83513 / 28-A02PT	MK-235-009-135-0000-0B7	M83513 / 28-B03NP	MK-235-015-145-0000	M83513 / 28-D01NP	MK-232-025-125-2200
M83513 / 28-A02PW	MK-235-009-135-2200-0B7	M83513 / 28-B03PP	MK-235-015-145-2200	M83513 / 28-D01NT	MK-232-025-125-0000-0B7
M83513 / 28-A03CN	MK-233-009-145-0000	M83513 / 28-B03PT	MK-235-015-145-0000-0B7	M83513 / 28-D01NW	MK-232-025-125-2200-0B7
M83513 / 28-A03CP	MK-233-009-145-2200	M83513 / 28-B03PW	MK-235-015-145-2200-0B7	M83513 / 28-D01PN	MK-235-025-125-0000
M83513 / 28-A03CT	MK-233-009-145-0000-0B7			M83513 / 28-D01PP	MK-235-025-125-2200
M83513 / 28-A03CW	MK-233-009-145-2200-0B7	M83513 / 28-C01CN	MK-233-021-125-0000	M83513 / 28-D01PT	MK-235-025-125-0000-0B7
M83513 / 28-A03NN	MK-232-009-145-0000	M83513 / 28-C01CP	MK-233-021-125-2200	M83513 / 28-D01PW	MK-235-025-125-2200-0B7
M83513 / 28-A03NP	MK-232-009-145-2200	M83513 / 28-C01CT	MK-233-021-125-0000-0B7	M83513 / 28-D02CN	MK-233-025-135-0000
M83513 / 28-A03NT	MK-232-009-145-0000-0B7	M83513 / 28-C01CW	MK-233-021-125-2200-0B7	M83513 / 28-D02CP	MK-233-025-135-2200
M83513 / 28-A03NW	MK-232-009-145-2200-0B7	M83513 / 28-C01NN	MK-232-021-125-0000	M83513 / 28-D02CT	MK-233-025-135-0000-0B7
M83513 / 28-A03PN	MK-235-009-145-0000	M83513 / 28-C01NP	MK-232-021-125-2200	M83513 / 28-D02CW	MK-233-025-135-2200-0B7
M83513 / 28-A03PP	MK-235-009-145-2200	M83513 / 28-C01NT	MK-232-021-125-0000-0B7	M83513 / 28-D02NN	MK-232-025-135-0000
M83513 / 28-A03PT	MK-235-009-145-0000-0B7	M83513 / 28-C01NW	MK-232-021-125-2200-0B7	M83513 / 28-D02NP	MK-232-025-135-2200
M83513 / 28-A03PW	MK-235-009-145-2200-0B7	M83513 / 28-C01PN	MK-235-021-125-0000	M83513 / 28-D02NT	MK-232-025-135-0000-0B7
		M83513 / 28-C01PP	MK-235-021-125-2200	M83513 / 28-D02NW	MK-232-025-135-2200-0B7
M83513 / 28-B01CN	MK-233-015-125-0000	M83513 / 28-C01PT	MK-235-021-125-0000-0B7	M83513 / 28-D02PN	MK-235-025-135-0000
M83513 / 28-B01CP	MK-233-015-125-2200	M83513 / 28-C01PW	MK-235-021-125-2200-0B7	M83513 / 28-D02PP	MK-235-025-135-2200
M83513 / 28-B01CT	MK-233-015-125-0000-0B7	M83513 / 28-C02CN	MK-233-021-135-0000	M83513 / 28-D02PT	MK-235-025-135-0000-0B7
M83513 / 28-B01CW	MK-233-015-125-2200-0B7	M83513 / 28-C02CP	MK-233-021-135-2200	M83513 / 28-D02PW	MK-235-025-135-2200-0B7
M83513 / 28-B01NN	MK-232-015-125-0000	M83513 / 28-C02CT	MK-233-021-135-0000-0B7	M83513 / 28-D03CN	MK-233-025-145-0000
M83513 / 28-B01NP	MK-232-015-125-2200	M83513 / 28-C02CW	MK-233-021-135-2200-0B7	M83513 / 28-D03CP	MK-233-025-145-2200
M83513 / 28-B01NT	MK-232-015-125-0000-0B7	M83513 / 28-C02NN	MK-232-021-135-0000	M83513 / 28-D03CT	MK-233-025-145-0000-0B7
M83513 / 28-B01NW	MK-232-015-125-2200-0B7	M83513 / 28-C02NP	MK-232-021-135-2200	M83513 / 28-D03CW	MK-233-025-145-2200-0B7
M83513 / 28-B01PN	MK-235-015-125-0000	M83513 / 28-C02NT	MK-232-021-135-0000-0B7	M83513 / 28-D03NN	MK-232-025-145-0000
M83513 / 28-B01PP	MK-235-015-125-2200	M83513 / 28-C02NW	MK-232-021-135-2200-0B7	M83513 / 28-D03NP	MK-232-025-145-2200

## Military Cross Reference Chart

-- Continued from previous page

### M83513 / 28 (continued)

M83513 / 28-D03NT	MK-232-025-145-0000-0B7	M83513 / 28-E02PN	MK-235-031-135-0000	M83513 / 28-F01PT	MK-235-037-125-0000-0B7
M83513 / 28-D03NW	MK-232-025-145-2200-0B7	M83513 / 28-E02PP	MK-235-031-135-2200	M83513 / 28-F01PW	MK-235-037-125-2200-0B7
M83513 / 28-D03PN	MK-235-025-145-0000	M83513 / 28-E02PT	MK-235-031-135-0000-0B7	M83513 / 28-F02CN	MK-233-037-135-0000
M83513 / 28-D03PP	MK-235-025-145-2200	M83513 / 28-E02PW	MK-235-031-135-2200-0B7	M83513 / 28-F02CP	MK-233-037-135-2200
M83513 / 28-D03PT	MK-235-025-145-0000-0B7	M83513 / 28-E03CN	MK-233-031-145-0000	M83513 / 28-F02CT	MK-233-037-135-0000-0B7
M83513 / 28-D03PW	MK-235-025-145-2200-0B7	M83513 / 28-E03CP	MK-233-031-145-2200	M83513 / 28-F02CW	MK-233-037-135-2200-0B7
		M83513 / 28-E03CT	MK-233-031-145-0000-0B7	M83513 / 28-F02NN	MK-232-037-135-0000
M83513 / 28-E01CN	MK-233-031-125-0000	M83513 / 28-E03CW	MK-233-031-145-2200-0B7	M83513 / 28-F02NP	MK-232-037-135-2200
M83513 / 28-E01CP	MK-233-031-125-2200	M83513 / 28-E03NN	MK-232-031-145-0000	M83513 / 28-F02NT	MK-232-037-135-0000-0B7
M83513 / 28-E01CT	MK-233-031-125-0000-0B7	M83513 / 28-E03NP	MK-232-031-145-2200	M83513 / 28-F02NW	MK-232-037-135-2200-0B7
M83513 / 28-E01CW	MK-233-031-125-2200-0B7	M83513 / 28-E03NT	MK-232-031-145-0000-0B7	M83513 / 28-F02PN	MK-235-037-135-0000
M83513 / 28-E01NN	MK-232-031-125-0000	M83513 / 28-E03NW	MK-232-031-145-2200-0B7	M83513 / 28-F02PP	MK-235-037-135-2200
M83513 / 28-E01NP	MK-232-031-125-2200	M83513 / 28-E03PN	MK-235-031-145-0000	M83513 / 28-F02PT	MK-235-037-135-0000-0B7
M83513 / 28-E01NT	MK-232-031-125-0000-0B7	M83513 / 28-E03PP	MK-235-031-145-2200	M83513 / 28-F02PW	MK-235-037-135-2200-0B7
M83513 / 28-E01NW	MK-232-031-125-2200-0B7	M83513 / 28-E03PT	MK-235-031-145-0000-0B7	M83513 / 28-F03CN	MK-233-037-145-0000
M83513 / 28-E01PN	MK-235-031-125-0000	M83513 / 28-E03PW	MK-235-031-145-2200-0B7	M83513 / 28-F03CP	MK-233-037-145-2200
M83513 / 28-E01PP	MK-235-031-125-2200			M83513 / 28-F03CT	MK-233-037-145-0000-0B7
M83513 / 28-E01PT	MK-235-031-125-0000-0B7	M83513 / 28-F01CN	MK-233-037-125-0000	M83513 / 28-F03CW	MK-233-037-145-2200-0B7
M83513 / 28-E01PW	MK-235-031-125-2200-0B7	M83513 / 28-F01CP	MK-233-037-125-2200	M83513 / 28-F03NN	MK-232-037-145-0000
M83513 / 28-E02CN	MK-233-031-135-0000	M83513 / 28-F01CT	MK-233-037-125-0000-0B7	M83513 / 28-F03NP	MK-232-037-145-2200
M83513 / 28-E02CP	MK-233-031-135-2200	M83513 / 28-F01CW	MK-233-037-125-2200-0B7	M83513 / 28-F03NT	MK-232-037-145-0000-0B7
M83513 / 28-E02CT	MK-233-031-135-0000-0B7	M83513 / 28-F01NN	MK-232-037-125-0000	M83513 / 28-F03NW	MK-232-037-145-2200-0B7
M83513 / 28-E02CW	MK-233-031-135-2200-0B7	M83513 / 28-F01NP	MK-232-037-125-2200	M83513 / 28-F03PN	MK-235-037-145-0000
M83513 / 28-E02NN	MK-232-031-135-0000	M83513 / 28-F01NT	MK-232-037-125-0000-0B7	M83513 / 28-F03PP	MK-235-037-145-2200
M83513 / 28-E02NP	MK-232-031-135-2200	M83513 / 28-F01NW	MK-232-037-125-2200-0B7	M83513 / 28-F03PT	MK-235-037-145-0000-0B7
M83513 / 28-E02NT	MK-232-031-135-0000-0B7	M83513 / 28-F01PN	MK-235-037-125-0000	M83513 / 28-F03PW	MK-235-037-145-2200-0B7
M83513 / 28-E02NW	MK-232-031-135-2200-0B7	M83513 / 28-F01PP	MK-235-037-125-2200		

### M83513 / 29

M83513 / 29-G01CN	MK-333-051-125-0000	M83513 / 29-G02CN	MK-333-051-135-0000	M83513 / 29-G03CN	MK-333-051-145-0000
M83513 / 29-G01CP	MK-333-051-125-2200	M83513 / 29-G02CP	MK-333-051-135-2200	M83513 / 29-G03CP	MK-333-051-145-2200
M83513 / 29-G01CT	MK-333-051-125-0000-0B7	M83513 / 29-G02CT	MK-333-051-135-0000-0B7	M83513 / 29-G03CT	MK-333-051-145-0000-0B7
M83513 / 29-G01CW	MK-333-051-125-2200-0B7	M83513 / 29-G02CW	MK-333-051-135-2200-0B7	M83513 / 29-G03CW	MK-333-051-145-2200-0B7
M83513 / 29-G01NN	MK-332-051-125-0000	M83513 / 29-G02NN	MK-332-051-135-0000	M83513 / 29-G03NN	MK-332-051-145-0000
M83513 / 29-G01NP	MK-332-051-125-2200	M83513 / 29-G02NP	MK-332-051-135-2200	M83513 / 29-G03NP	MK-332-051-145-2200
M83513 / 29-G01NT	MK-332-051-125-0000-0B7	M83513 / 29-G02NT	MK-332-051-135-0000-0B7	M83513 / 29-G03NT	MK-332-051-145-0000-0B7
M83513 / 29-G01NW	MK-332-051-125-2200-0B7	M83513 / 29-G02NW	MK-332-051-135-2200-0B7	M83513 / 29-G03NW	MK-332-051-145-2200-0B7
M83513 / 29-G01PN	MK-335-051-125-0000	M83513 / 29-G02PN	MK-335-051-135-0000	M83513 / 29-G03PN	MK-335-051-145-0000
M83513 / 29-G01PP	MK-335-051-125-2200	M83513 / 29-G02PP	MK-335-051-135-2200	M83513 / 29-G03PP	MK-335-051-145-2200
M83513 / 29-G01PT	MK-335-051-125-0000-0B7	M83513 / 29-G02PT	MK-335-051-135-0000-0B7	M83513 / 29-G03PT	MK-335-051-145-0000-0B7
M83513 / 29-G01PW	MK-335-051-125-2200-0B7	M83513 / 29-G02PW	MK-335-051-135-2200-0B7	M83513 / 29-G03PW	MK-335-051-145-2200-0B7

### M83513 / 30

M83513 / 30-H01CN	MK-433-100-125-0000	M83513 / 30-H02CN	MK-433-100-135-0000	M83513 / 30-H03CN	MK-433-100-145-0000
M83513 / 30-H01CP	MK-433-100-125-6200	M83513 / 30-H02CP	MK-433-100-135-6200	M83513 / 30-H03CP	MK-433-100-145-6200
M83513 / 30-H01CT	MK-433-100-125-0000-0B7	M83513 / 30-H02CT	MK-433-100-135-0000-0B7	M83513 / 30-H03CT	MK-433-100-145-0000-0B7
M83513 / 30-H01CW	MK-433-100-125-6200-0B7	M83513 / 30-H02CW	MK-433-100-135-6200-0B7	M83513 / 30-H03CW	MK-433-100-145-6200-0B7
M83513 / 30-H01NN	MK-432-100-125-0000	M83513 / 30-H02NN	MK-432-100-135-0000	M83513 / 30-H03NN	MK-432-100-145-0000
M83513 / 30-H01NP	MK-432-100-125-6200	M83513 / 30-H02NP	MK-432-100-135-6200	M83513 / 30-H03NP	MK-432-100-145-6200
M83513 / 30-H01NT	MK-432-100-125-0000-0B7	M83513 / 30-H02NT	MK-432-100-135-0000-0B7	M83513 / 30-H03NT	MK-432-100-145-0000-0B7
M83513 / 30-H01NW	MK-432-100-125-6200-0B7	M83513 / 30-H02NW	MK-432-100-135-6200-0B7	M83513 / 30-H03NW	MK-432-100-145-6200-0B7
M83513 / 30-H01PN	MK-435-100-125-0000	M83513 / 30-H02PN	MK-435-100-135-0000	M83513 / 30-H03PN	MK-435-100-145-0000
M83513 / 30-H01PP	MK-435-100-125-6200	M83513 / 30-H02PP	MK-435-100-135-6200	M83513 / 30-H03PP	MK-435-100-145-6200
M83513 / 30-H01PT	MK-435-100-125-0000-0B7	M83513 / 30-H02PT	MK-435-100-135-0000-0B7	M83513 / 30-H03PT	MK-435-100-145-0000-0B7
M83513 / 30-H01PW	MK-435-100-125-6200-0B7	M83513 / 30-H02PW	MK-435-100-135-6200-0B7	M83513 / 30-H03PW	MK-435-100-145-6200-0B7



## Military Cross Reference Chart

-- Continued from previous page

### M83513 / 31 (continued)

M83513 / 31-E02NT	MK-242-031-235-0000-0B7	M83513 / 31-F01CN	MK-243-037-225-0000-900	M83513 / 31-F02NT	MK-242-037-235-0000-0B7
M83513 / 31-E02NW	MK-242-031-235-2200-0B7	M83513 / 31-F01CP	MK-243-037-225-2200-900	M83513 / 31-F02NW	MK-242-037-235-2200-0B7
M83513 / 31-E02PN	MK-245-031-235-0000-900	M83513 / 31-F01CT	MK-243-037-225-0000-0B7	M83513 / 31-F02PN	MK-245-037-235-0000-900
M83513 / 31-E02PP	MK-245-031-235-2200-900	M83513 / 31-F01CW	MK-243-037-225-2200-0B7	M83513 / 31-F02PP	MK-245-037-235-2200-900
M83513 / 31-E02PT	MK-245-031-235-0000-0B7	M83513 / 31-F01NN	MK-242-037-225-0000-900	M83513 / 31-F02PT	MK-245-037-235-0000-0B7
M83513 / 31-E02PW	MK-245-031-235-2200-0B7	M83513 / 31-F01NP	MK-242-037-225-2200-900	M83513 / 31-F02PW	MK-245-037-235-2200-0B7
M83513 / 31-E03CN	MK-243-031-245-0000-900	M83513 / 31-F01NT	MK-242-037-225-0000-0B7	M83513 / 31-F03CN	MK-243-037-245-0000-900
M83513 / 31-E03CP	MK-243-031-245-2200-900	M83513 / 31-F01NW	MK-242-037-225-2200-0B7	M83513 / 31-F03CP	MK-243-037-245-2200-900
M83513 / 31-E03CT	MK-243-031-245-0000-0B7	M83513 / 31-F01PN	MK-245-037-225-0000-900	M83513 / 31-F03CT	MK-243-037-245-0000-0B7
M83513 / 31-E03CW	MK-243-031-245-2200-0B7	M83513 / 31-F01PP	MK-245-037-225-2200-900	M83513 / 31-F03CW	MK-243-037-245-2200-0B7
M83513 / 31-E03NN	MK-242-031-245-0000-900	M83513 / 31-F01PT	MK-245-037-225-0000-0B7	M83513 / 31-F03NN	MK-242-037-245-0000-900
M83513 / 31-E03NP	MK-242-031-245-2200-900	M83513 / 31-F01PW	MK-245-037-225-2200-0B7	M83513 / 31-F03NP	MK-242-037-245-2200-900
M83513 / 31-E03NT	MK-242-031-245-0000-0B7	M83513 / 31-F02CN	MK-243-037-235-0000-900	M83513 / 31-F03NT	MK-242-037-245-0000-0B7
M83513 / 31-E03NW	MK-242-031-245-2200-0B7	M83513 / 31-F02CP	MK-243-037-235-2200-900	M83513 / 31-F03NW	MK-242-037-245-2200-0B7
M83513 / 31-E03PN	MK-245-031-245-0000-900	M83513 / 31-F02CT	MK-243-037-235-0000-0B7	M83513 / 31-F03PN	MK-245-037-245-0000-900
M83513 / 31-E03PP	MK-245-031-245-2200-900	M83513 / 31-F02CW	MK-243-037-235-2200-0B7	M83513 / 31-F03PP	MK-245-037-245-2200-900
M83513 / 31-E03PT	MK-245-031-245-0000-0B7	M83513 / 31-F02NN	MK-242-037-235-0000-900	M83513 / 31-F03PT	MK-245-037-245-0000-0B7
M83513 / 31-E03PW	MK-245-031-245-2200-0B7	M83513 / 31-F02NP	MK-242-037-235-2200-900	M83513 / 31-F03PW	MK-245-037-245-2200-0B7

### M83513 / 32

M83513 / 32-G01CN	MK-343-051-225-0000-900	M83513 / 32-G02CN	MK-343-051-235-0000-900	M83513 / 32-G03CN	MK-343-051-245-0000-900
M83513 / 32-G01CP	MK-343-051-225-2200-900	M83513 / 32-G02CP	MK-343-051-235-2200-900	M83513 / 32-G03CP	MK-343-051-245-2200-900
M83513 / 32-G01CT	MK-343-051-225-0000-0B7	M83513 / 32-G02CT	MK-343-051-235-0000-0B7	M83513 / 32-G03CT	MK-343-051-245-0000-0B7
M83513 / 32-G01CW	MK-343-051-225-2200-0B7	M83513 / 32-G02CW	MK-343-051-235-2200-0B7	M83513 / 32-G03CW	MK-343-051-245-2200-0B7
M83513 / 32-G01NN	MK-342-051-225-0000-900	M83513 / 32-G02NN	MK-342-051-235-0000-900	M83513 / 32-G03NN	MK-342-051-245-0000-900
M83513 / 32-G01NP	MK-342-051-225-2200-900	M83513 / 32-G02NP	MK-342-051-235-2200-900	M83513 / 32-G03NP	MK-342-051-245-2200-900
M83513 / 32-G01NT	MK-342-051-225-0000-0B7	M83513 / 32-G02NT	MK-342-051-235-0000-0B7	M83513 / 32-G03NT	MK-342-051-245-0000-0B7
M83513 / 32-G01NW	MK-342-051-225-2200-0B7	M83513 / 32-G02NW	MK-342-051-235-2200-0B7	M83513 / 32-G03NW	MK-342-051-245-2200-0B7
M83513 / 32-G01PN	MK-345-051-225-0000-900	M83513 / 32-G02PN	MK-345-051-235-0000-900	M83513 / 32-G03PN	MK-345-051-245-0000-900
M83513 / 32-G01PP	MK-345-051-225-2200-900	M83513 / 32-G02PP	MK-345-051-235-2200-900	M83513 / 32-G03PP	MK-345-051-245-2200-900
M83513 / 32-G01PT	MK-345-051-225-0000-0B7	M83513 / 32-G02PT	MK-345-051-235-0000-0B7	M83513 / 32-G03PT	MK-345-051-245-0000-0B7
M83513 / 32-G01PW	MK-345-051-225-2200-0B7	M83513 / 32-G02PW	MK-345-051-235-2200-0B7	M83513 / 32-G03PW	MK-345-051-245-2200-0B7

### M83513 / 33

M83513 / 33-H01CN	MK-443-100-225-0000-900	M83513 / 33-H02CN	MK-443-100-235-0000-900	M83513 / 33-H03CN	MK-443-100-245-0000-900
M83513 / 33-H01CP	MK-443-100-225-6200-900	M83513 / 33-H02CP	MK-443-100-235-6200-900	M83513 / 33-H03CP	MK-443-100-245-6200-900
M83513 / 33-H01CT	MK-443-100-225-0000-0B7	M83513 / 33-H02CT	MK-443-100-235-0000-0B7	M83513 / 33-H03CT	MK-443-100-245-0000-0B7
M83513 / 33-H01CW	MK-443-100-225-6200-0B7	M83513 / 33-H02CW	MK-443-100-235-6200-0B7	M83513 / 33-H03CW	MK-443-100-245-6200-0B7
M83513 / 33-H01NN	MK-442-100-225-0000-900	M83513 / 33-H02NN	MK-442-100-235-0000-900	M83513 / 33-H03NN	MK-442-100-245-0000-900
M83513 / 33-H01NP	MK-442-100-225-6200-900	M83513 / 33-H02NP	MK-442-100-235-6200-900	M83513 / 33-H03NP	MK-442-100-245-6200-900
M83513 / 33-H01NT	MK-442-100-225-0000-0B7	M83513 / 33-H02NT	MK-442-100-235-0000-0B7	M83513 / 33-H03NT	MK-442-100-245-0000-0B7
M83513 / 33-H01NW	MK-442-100-225-6200-0B7	M83513 / 33-H02NW	MK-442-100-235-6200-0B7	M83513 / 33-H03NW	MK-442-100-245-6200-0B7
M83513 / 33-H01PN	MK-445-100-225-0000-900	M83513 / 33-H02PN	MK-445-100-235-0000-900	M83513 / 33-H03PN	MK-445-100-245-0000-900
M83513 / 33-H01PP	MK-445-100-225-6200-900	M83513 / 33-H02PP	MK-445-100-235-6200-900	M83513 / 33-H03PP	MK-445-100-245-6200-900
M83513 / 33-H01PT	MK-445-100-225-0000-0B7	M83513 / 33-H02PT	MK-445-100-235-0000-0B7	M83513 / 33-H03PT	MK-445-100-245-0000-0B7
M83513 / 33-H01PW	MK-445-100-225-6200-0B7	M83513 / 33-H02PW	MK-445-100-235-6200-0B7	M83513 / 33-H03PW	MK-445-100-245-6200-0B7







# The AirBorn Advantage

<p>Model-To-Market Solutions</p> 	<p>Rugged Power Systems</p> 	<p>Photonics/Optoelectronics</p> 			
 <p>Flexible Circuit Assemblies</p>	 <p>Cable Assemblies</p>	 <p>FUZE Assemblies</p>	 <p>Active Optical Assemblies</p>		
 <p>Rectangular W Series</p>	 <p>Rectangular R Series</p>	 <p>Micro D M Series</p>	 <p>Nano D N Series</p>	 <p>Rectangular 25Gbps verSI</p>	 <p>Z Axis Interposer Z Series</p>
 <p>Hybrid-Keyed Micro D microQUAD</p>	 <p>High-Speed Micro D microSI</p>	 <p>Stackable RC &amp; RCII Series</p>	 <p>Circular Series 360</p>	 <p>Strip Connector AirStrip</p>	 <p>Macro D RockKet</p>

MSC-4.21



p. 512.863.5585  
www.airborn.com

## X-ON Electronics

Largest Supplier of Electrical and Electronic Components

*Click to view similar products for [Board to Board & Mezzanine Connectors](#) category:*

*Click to view products by [AirBorn](#) manufacturer:*

Other Similar products are found below :

[589158040000018](#) [MDF7C-18P-2.54DSA\(55\)](#) [FCN-230C068-11](#) [FCN-268F012-G/BD](#) [FCN-268F036-G/BD](#) [FCN-268M012-G/0D](#) [FCN-268M024-G/1D](#) [FCN-723J004/1](#) [MIS-048-01-F-D-DP-K](#) [832-10-034-10-001000](#) [FX4C-80S-1.27DSA](#) [FCN-214Q030-G/0](#) [FCN-234P048-G/0](#) [FCN-235D050-G/C](#) [210-93-314-41-105000](#) [2-22603-0](#) [MDF7-40DP-2.54DSA\(55\)](#) [AXG720047](#) [5031084030](#) [MIT-114-03-F-D-K](#) [55323-1519](#) [DF33-2P-3.3DSA\(24\)](#) [YFT-20-05-H-03-SB-K](#) [503308-3040](#) [026-6203-PDB](#) [027-6203-PDB](#) [069159702701000](#) [10123981-102LF](#) [101A10019X](#) [55650-0588-C](#) [68682-310LF](#) [68684-306](#) [75140-7012](#) [87471-650](#) [YTW-30-07-H-Q-410-140](#) [194261-1](#) [FCN-268F024-G0D](#) [10124054-515LF](#) [68685-603](#) [8-1616154-3](#) [MIS-019-01-F-D](#) [FCN-268M024-G/3D](#) [20021832-06016C1LF](#) [KX15-20KLDL-E1000E](#) [MDF7-16DP-2.54DSA\(55\)](#) [AXE810124](#) [FCN-214J100-G/0](#) [FCN-230C068-E/S](#) [AXE812124](#) [AXE816124](#)