

GNSS L1 Ceramic Patch Antenna

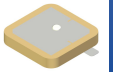

AANI-PP-0055

Request Samples



Check Inventory



25.0 x 25.0 x 4.0mm

RoHS Compliant

MSL Level = N/A

Features

- Multi-Constellation Passive GNSS Antenna
 - GPS: L1
 - GLONASS: G1
 - BeiDou: B1
 - Galileo: E1
 - QZSS: L1
 - SBAS: L1
- RHCP Polarization
- Small Size of 25.0 x 25.0 x 4.0 mm
- Light Weight

Applications

- IoT / M2M
- Unmanned Aerial Vehicle (UAV)
- Fleet Management and Asset Tracking
- Transportation
- Precision Agriculture
- Geolocation and Tracking

Product Image

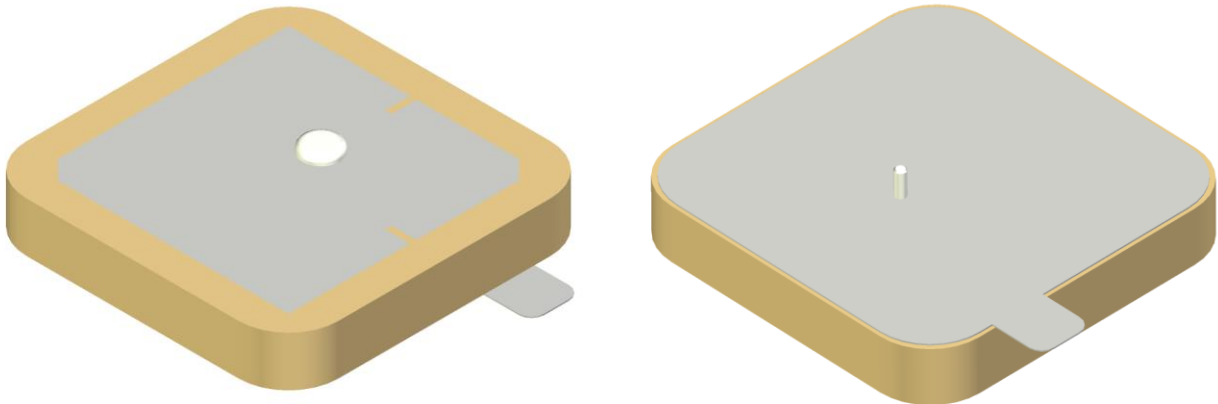

GNSS L1 Ceramic Patch Antenna

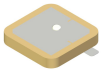

AANI-PP-0055

Request Samples



Check Inventory



25.0 x 25.0 x 4.0mm
RoHS Compliant
MSL Level = N/A

GNSS Frequency Bands Covered

System	Band	Frequency Range	Frequency
GPS	L1	1575.42MHz	■
	L2	1227.6MHz	□
GLONASS	G1	1598.06-1609.31MHz	■
	G2	1242.93-1251.68MHz	□
Galileo	E1	1575.42MHz	■
	E5a	1176.45MHz	□
BeiDou	B1	1561MHz	■
	B2	1207.14MHz	□
QZSS	L1	1575.42MHz	■
	L2	1227.6MHz	□
IRNSS/NAVIC	L5	1176.45MHz	□
	L6	1278.75MHz	□
SBAS	L1/E1/B1	1575.42MHz	■
	L5/B2a/E5a	1176.45MHz	□

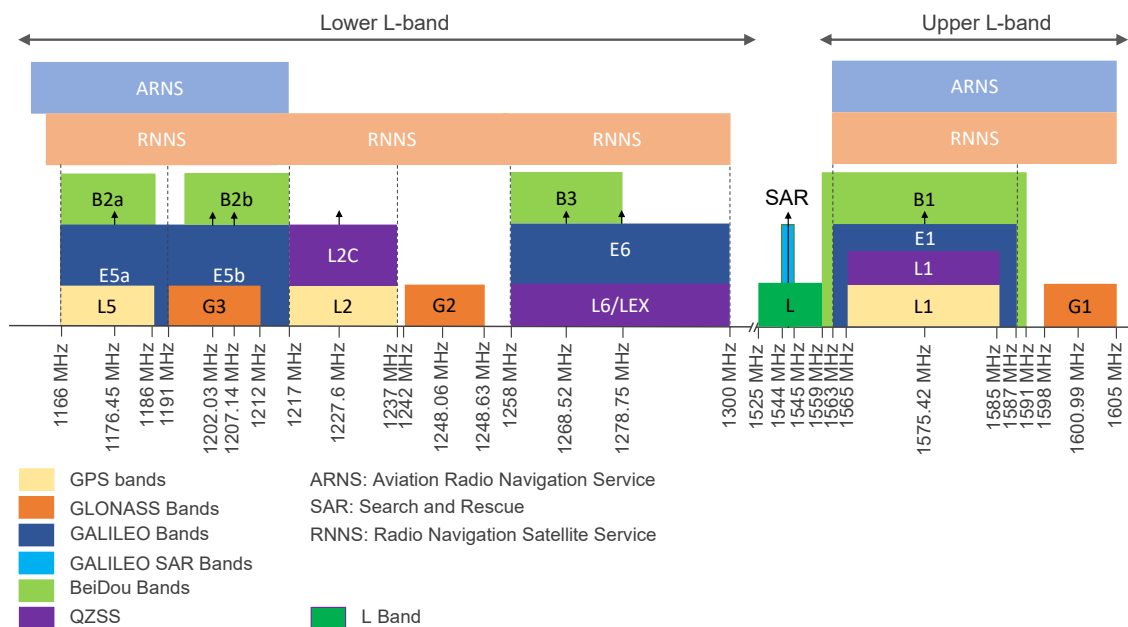

Frequency allocation: GNSS systems, upper L bands and lower L bands



5101 Hidden Creek Ln Spicewood TX 78669
 Phone: 512-371-6159 | Fax: 512-351-8858
 For terms and conditions of sales, please visit:
www.abracon.com

REVISED: 08-27-24

ABRACON IS
 ISO9001-2015
 CERTIFIED

GNSS L1 Ceramic Patch Antenna

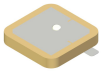

AANI-PP-0055

Request Samples



Check Inventory



25.0 x 25.0 x 4.0mm
RoHS Compliant
 MSL Level = N/A

Electrical Specification

Parameters	Typ.	Units	Note
Antenna			
Frequency	GPS: L1 GLONASS: G1 Beidou: B1 Galileo: E1 QZSS: L1 SBAS: L1/E1/B1	-	
VSWR	< 2.0	-	
Polarization	RHCP	-	(Right Hand Circular Polarization)
Nominal Impedance	50	Ω	
Peak Gain	> 4.0	dBic	L1 (1575.42 MHz)/G1 (1602MHz)
Efficiency	> 75	%	L1 (1575.42 MHz)/G1 (1602MHz)
Axial Ratio	< 5.0		L1 (1575.42 MHz)/G1 (1602MHz)

Note: With 60 x 60 mm Ground Plate

Mechanical Specification

Parameter	Specification
Antenna Dimension	25.0 x 25.0 x 4.0mm
Mounting Type	Through hole

Environmental Specification

Parameter	Specification
Operating Temperature	-40°C to +85°C
Storage Temperature	-40°C to +110°C
RoHS Compliance	Yes



5101 Hidden Creek Ln Spicewood TX 78669
 Phone: 512-371-6159 | Fax: 512-351-8858
 For terms and conditions of sales, please visit:
www.abracon.com

REVISED: 08-27-24

ABRACON IS
 ISO9001-2015
 CERTIFIED

GNSS L1 Ceramic Patch Antenna



AANI-PP-0055

Request Samples



Check Inventory



25.0 x 25.0 x 4.0mm

RoHS Compliant

MSL Level = N/A

Ordering Information

Part Number	Description
AANI-PP-0055	GNSS L1 Ceramic Patch Antenna
AANI-PP-0055-EVB	GNSS L1 Ceramic Patch Antenna EVB

GNSS L1 Ceramic Patch Antenna

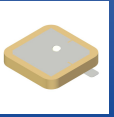

AANI-PP-0055

Request Samples



Check Inventory



25.0 x 25.0 x 4.0mm
RoHS Compliant
MSL Level = N/A

Product Dimensions

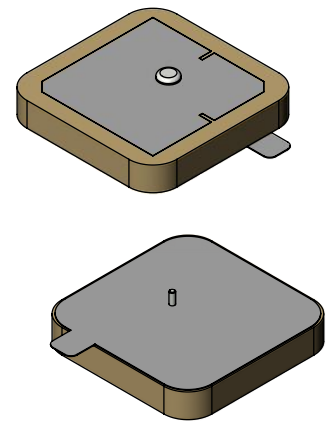
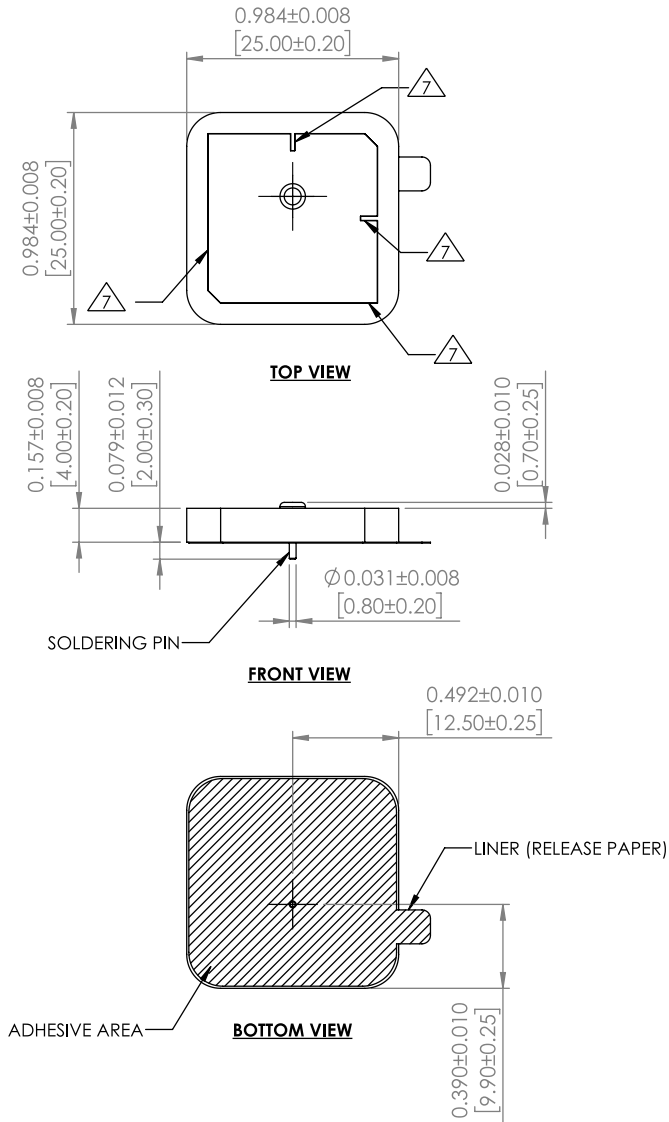

Unit: inches [mm]

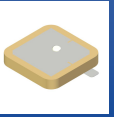

AANI-PP-0055

Request Samples



Check Inventory



25.0 x 25.0 x 4.0mm

RoHS Compliant

MSL Level = N/A

PCB Footprint

TOP VIEW

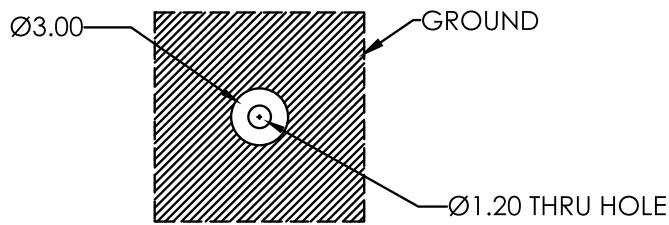

BOTTOM VIEW

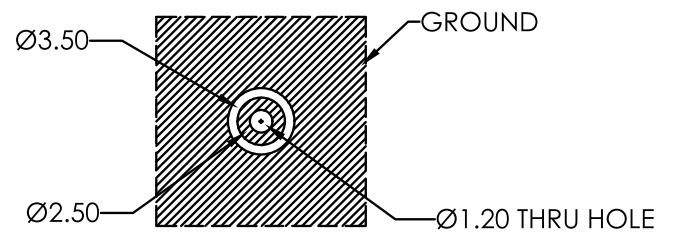

Tolerance : ± 0.20

Unit : mm

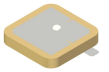

AANI-PP-0055

Request Samples



Check Inventory



25.0 x 25.0 x 4.0mm
RoHS Compliant
MSL Level = N/A

Measurement Setup

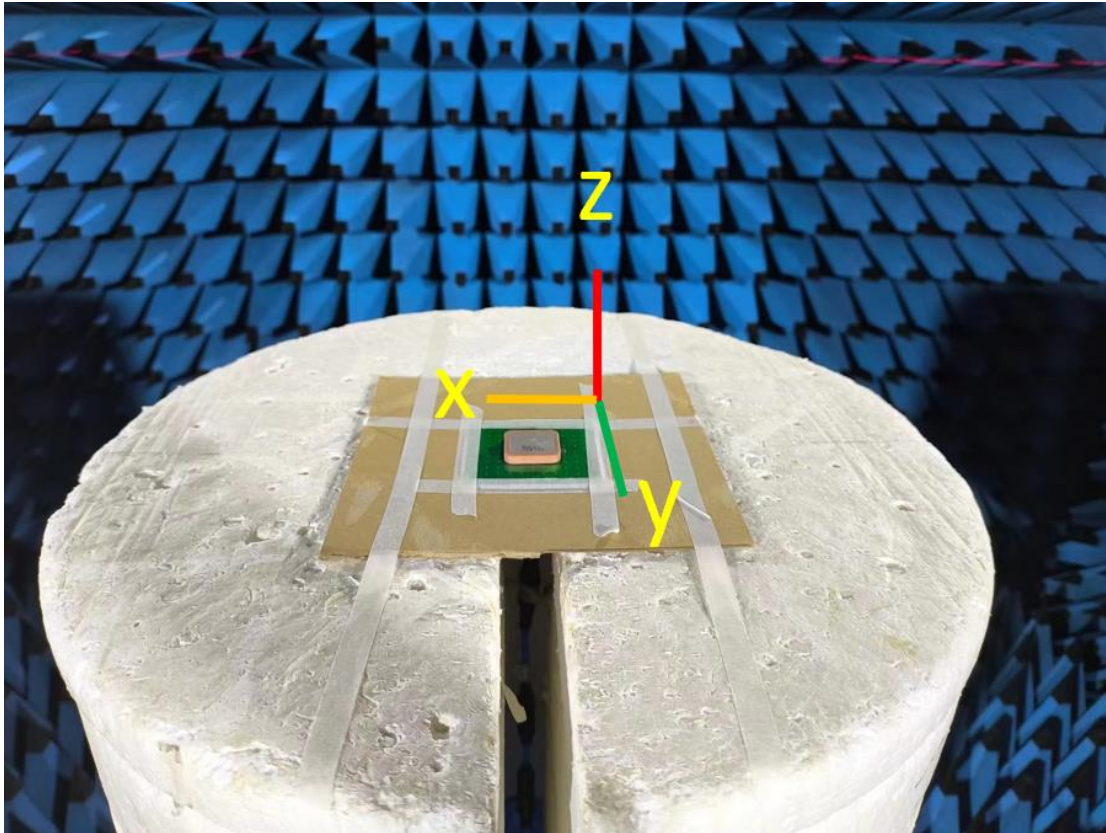

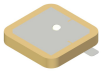

AANI-PP-0055

Request Samples



Check Inventory



25.0 x 25.0 x 4.0mm
RoHS Compliant
MSL Level = N/A

Reflection Characteristics – Return Loss & VSWR

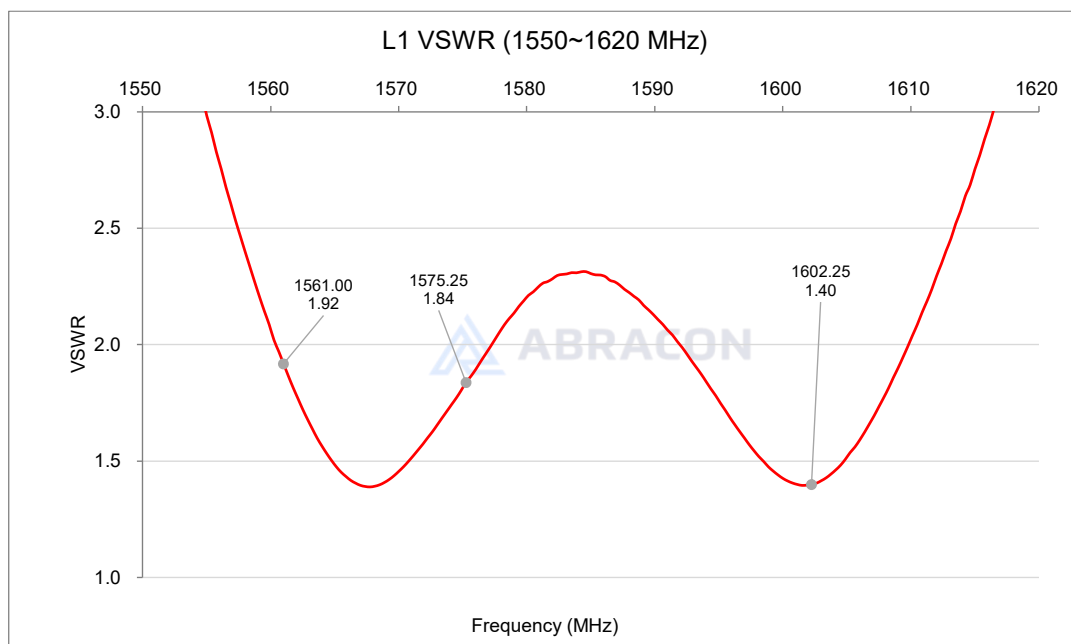
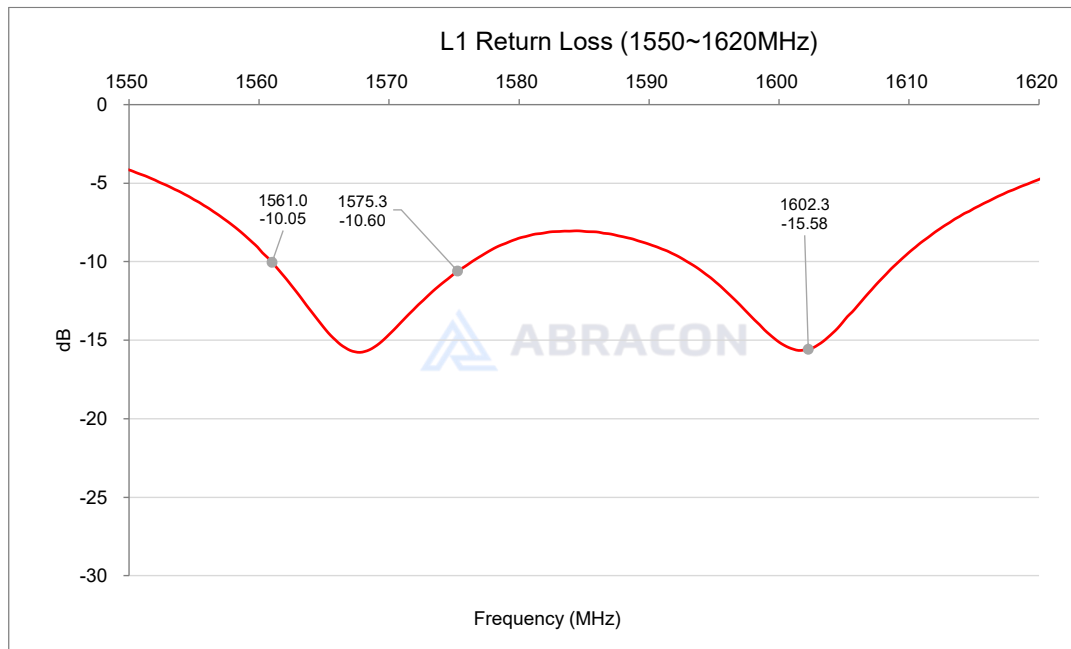



AANI-PP-0055

Request Samples



Check Inventory



25.0 x 25.0 x 4.0mm
RoHS Compliant
MSL Level = N/A

Radiation Characteristics – Peak Gain

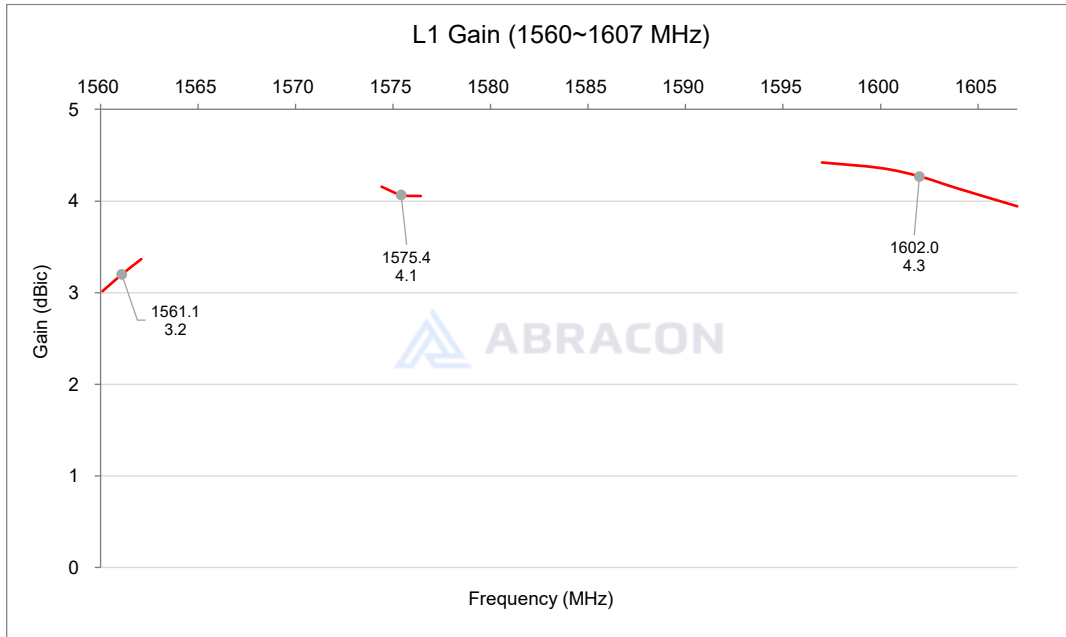

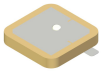

AANI-PP-0055

Request Samples



Check Inventory



25.0 x 25.0 x 4.0mm
RoHS Compliant
MSL Level = N/A

Radiation Characteristics – Total Efficiency (%)

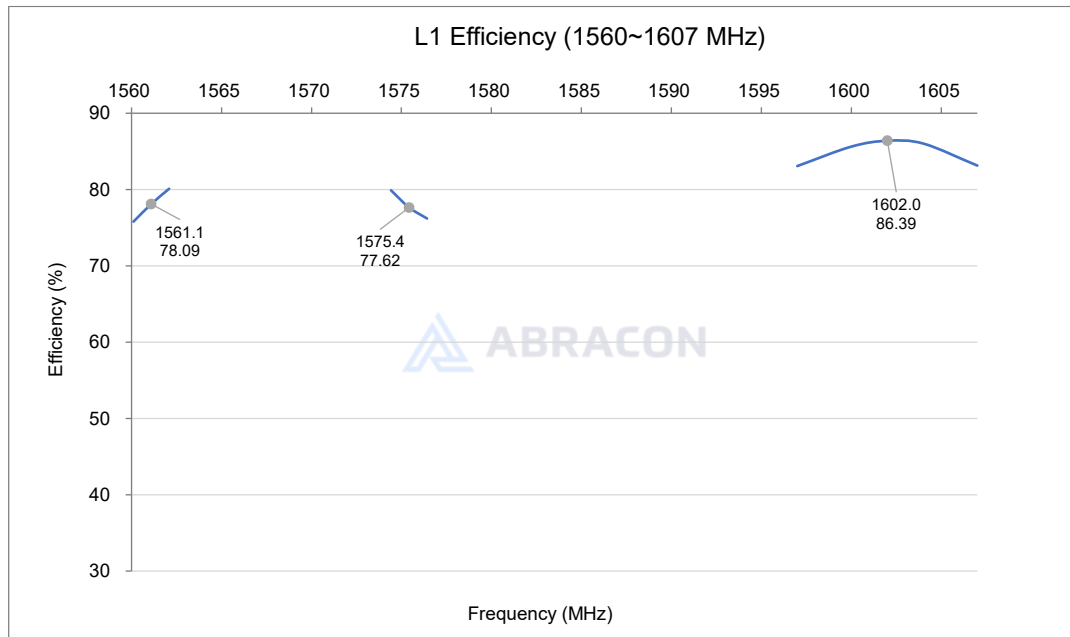

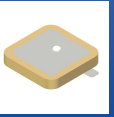

AANI-PP-0055

Request Samples



Check Inventory



25.0 x 25.0 x 4.0mm
RoHS Compliant
MSL Level = N/A

Radiation Characteristics – 3D & 2D Pattern

1575MHz

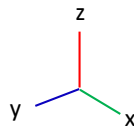
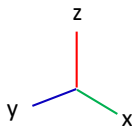
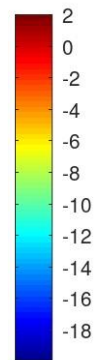
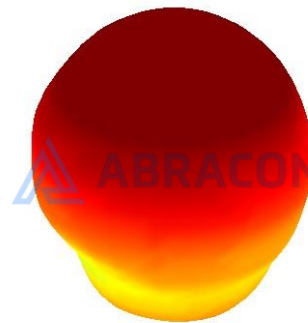
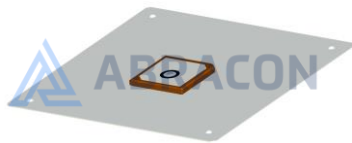

XY plane

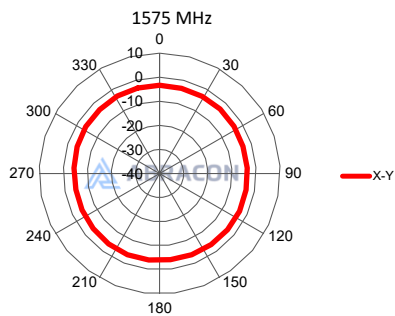

XZ plane

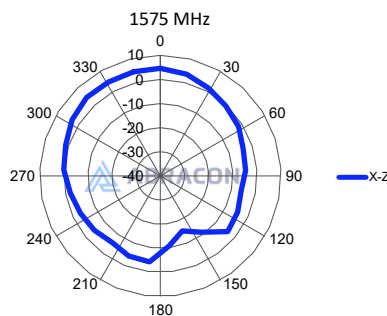

YZ plane

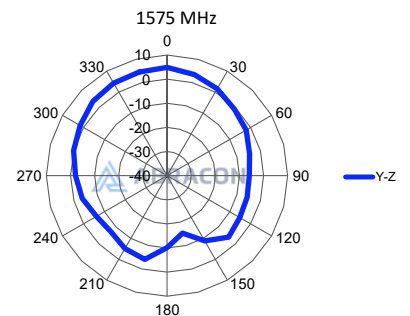

GNSS L1 Ceramic Patch Antenna

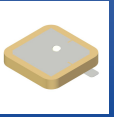

AANI-PP-0055

Request Samples



Check Inventory



25.0 x 25.0 x 4.0mm
RoHS Compliant
MSL Level = N/A

1602MHz

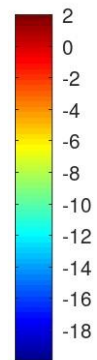
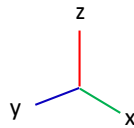
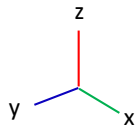
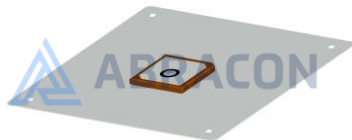

XY plane

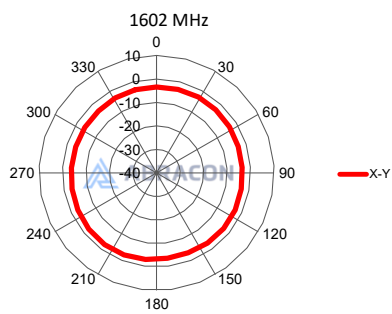

XZ plane

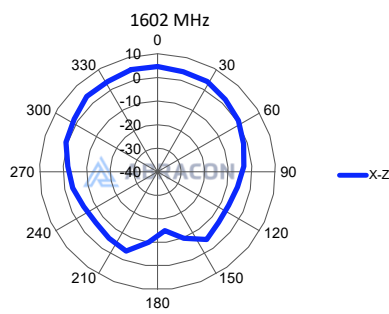

YZ plane

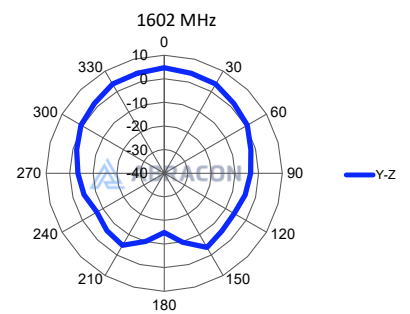

GNSS L1 Ceramic Patch Antenna

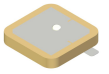

AANI-PP-0055

Request Samples



Check Inventory



25.0 x 25.0 x 4.0mm

RoHS Compliant

MSL Level = N/A

Packaging

1. 50 pcs per tray
2. 500 pcs per inner box
3. 1000 pcs per carton

Dimension of the carton: 345 x 210 x 255 mm

ATTENTION: Abracon LLC's products are Commercial-Off-The-Shelf ('COTS'), which are designed, intended, and validated for use in commercial, industrial, and automotive applications. The customer is responsible for testing and verifying the performance of an Abracon solution to meet their system-level requirements.



5101 Hidden Creek Ln Spicewood TX 78669
Phone: 512-371-6159 | Fax: 512-351-8858
For terms and conditions of sales, please visit:
www.abracon.com

REVISED: 08-27-24

ABRACON IS
ISO9001-2015
CERTIFIED

X-ON Electronics

Largest Supplier of Electrical and Electronic Components

Click to view similar products for [Antennas](#) category:

Click to view products by [Abracon](#) manufacturer:

Other Similar products are found below :

[930-033-R](#) [108-00014-50](#) [66089-2406](#) [A09-F8NF-M](#) [RGFRA1903041A1T](#) [108-00016-050](#) [W1049B090](#) [WTL2449CQ1-FRSMM](#) [CPL9C](#)
[0600-00060](#) [PAL90209H-FNF](#) [GD53-25](#) [S9025PLSMF](#) [GPSCPMM00](#) [ANTDOM-05-01-WPM](#) [ANT-WP868SMA-Y](#) [CBNC58](#) [MD10-004](#)
[ABFT](#) [LP800NMOW](#) [NMOQ88C](#) [NMOQB](#) [NMOQC](#) [ANT-GSMGPSPUKS](#) [60210](#) [60140](#) [ANT-8WPIG-UFL](#) [ANT-GPSPUKS](#) [A21H0](#)
[29000863](#) [29000848](#) [955179003](#) [22100003](#) [DL-T022-2.4G](#) [DL-T023-4G](#) [T1-915M](#) [DL-T021-2.4GW](#) [DL-T021-2.4G](#) [KH-IPEX-1.13](#)
[BWGNXCX16-6B1Y2L120](#) [BWGNXCX15-15B1Y4L120](#) [DL-T023-4GW](#) [J008-GSM](#) [3N0401LG-021](#) [KHA\(RG1.13\)-TX90B-IPEX](#) [KH-](#)
[GPS181804-WY](#) [KHA\(RG1.13\)-TX80B-IPEX](#) [TX5800-JZ-5](#) [KH-137-TX90B-IPEX4](#) [KH-113-TX100B-IPEX4](#)