

PRODUCT IDENTIFICATION

DPWC 0805S – 900

Type | Size | Impedance

FEATURES

- ◆ Common mode choke with magnetic shield.
- ◆ Excellent solderability and resistance to soldering heat.
- ◆ High reliability and easy surface mount.
- ◆ Low DC resistance, high current tolerance performance.

APPLICATIONS

- ◆ Notebook
- ◆ PC's
- ◆ USB
- ◆ HUB

DIMENSIONS (mm)

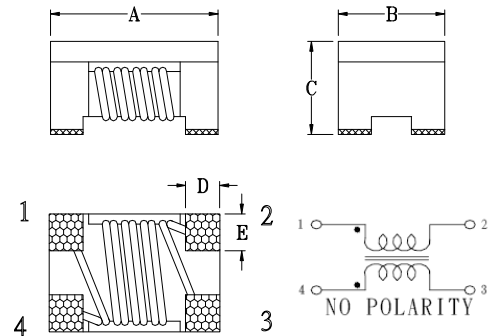

No.	Part No.	Size (mm)				
		A	B	C	D	E
1	DPWC 0805S	2.0 ± 0.2	1.2 ± 0.2	1.2 ± 0.2	0.45 ± 0.1	0.4 ± 0.1

SERIES LIST

No.	Part No.	Impedance (Ω) at 100MHz	RDC (Ω) Max.	IDC (mA) Max.
1	DPWC 0805S-670	67±25%	0.25	400
2	DPWC 0805S-900	90±25%	0.35	330
3	DPWC 0805S-121	120±25%	0.30	370
4	DPWC 0805S-161	160±25%	0.35	330
5	DPWC 0805S-181	180±25%	0.35	330
6	DPWC 0805S-221	220±25%	0.35	310
7	DPWC 0805S-261	260±25%	0.40	300
8	DPWC 0805S-361	360±25%	0.45	280
9	DPWC 0805S-371	370±25%	0.45	280

RECOMMENDED PATTERN

Type	A	B	C	D	E
DPWC 0805	2.6	1.2	0.4	0.9	0.8

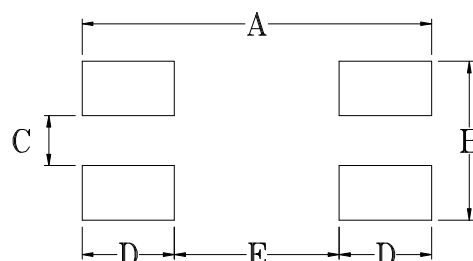

PACKAGE

Type	DPWC 0805S
Q'TY/Reel	2,000

1. Scope

This specification applies to wired wounded chip common mode choke of the following types used in electronic equipment :

Material : Ferrite

2. Construction

Configuration

& Dimension : Please refer to the attached figures and tables.

Terminals : DPWC series shall consist of Ag followed by Nickel, then solder plating.

3. Operating Temperature Range

Operating Temperature Range is the scope of ambient temperature at which the common mode choke can be operated continuously at rated current.

Temp. Range : - 40 °C to + 85 °C

4. Recommended Soldering Conditions

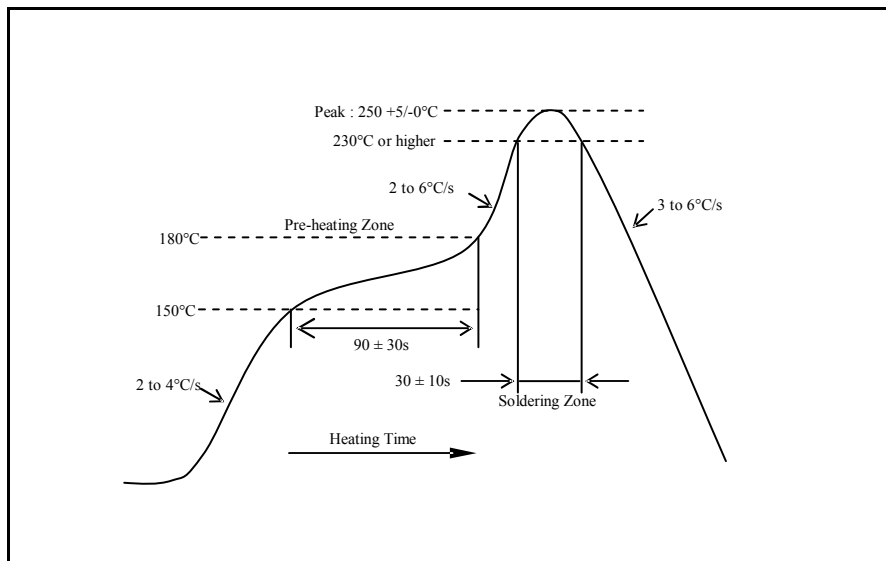

5 Characteristics

Standard Atmospheric Conditions

Unless otherwise specified, the standard range of atmospheric conditions for making measurements and tests are as follows :

Ambient Temperature : 25°C (20°C) $\pm 2^\circ\text{C}$

Relative Humidity : 60% to 70% (RH)

Air Pressure : 86 Kpa to 106 Kpa

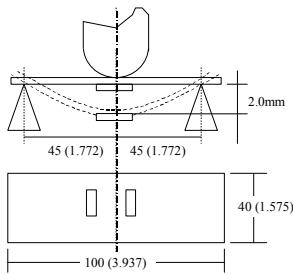
	ITEM	CONDITION	SPECIFICATION
Electrical Characteristics	Common Mode Impedance (Zc) and Tolerance	Measuring Equipment : HP-4287A or equivalent. Measuring Frequency : 100 ± 1MHz Measuring Temperature : 25 ± 5°C (Refer to Measurement Diagram)	Within ± 25%
	Insulation Resistance	Measuring Voltage : Rated Voltage Measuring Time : 1 minute max. (Refer to Measurement Diagram)	10 megaohms minimum
	Dielectric Withstanding Voltage	Test Voltage : 2.5 times for Rated Voltage Time : 1 to 5 seconds. Charge current : 1mA max. (Refer to Measurement Diagram)	No damage occurs when the test voltage is applied.
	Rated Current	Test Current : Rated Current (Refer to Measurement Diagram)	Temperature Rise : ≤ 15°C
	DC Resistance (RDC)	Measured with current of 100mA max. In case of doubt, measured by four terminal method. (Refer to Measurement Diagram)	Within Specified Tolerance.
Mechanical Characteristics	Flexure Strength		Table 1. <div style="border: 1px solid black; padding: 5px;"> Change In Appearance Without distinct damage Change In Common Mode Impedance: Within ± 20% Insulation Resistance: 10MΩ min Withstanding Voltage: No damaged </div>
	Drop Test	Components shall be dropped three times on a concrete or steel board at height of 1m naturally at any directions.	
	Vibration (Random)	Components shall be randomly vibrated at amplitude of 1.5mm and frequency of 10 - 55 Hz: 0.04 G / Hz, 1 minute at a period of 2 hours in each of the three mutually perpendicular directions.	
	Solderability	Dip pads in flux and then in a solder pot containing lead free solder at 240 °C ± 5°C for 5 seconds.	A minimum of 80% of the metalized area must be covered with new solder.

	ITEM	CONDITION	SPECIFICATION
Mechanical Characteristics	Resistance to Soldering Heat	Preheat components at 80 to 120 °C for 1 minute. Dip components into flux and then into a solder pot containing lead free solder at 260 °C ± 5 °C for 5 ± 1 seconds. Then components are to be tested after 4-48 hours at room temperature.	Meet Table 1.
	Component Adhesion (Push Test)	Components shall be reflow soldered onto a P. C. Board (240 °C ± 5°C for 20 seconds). Then a dynamometer force gauge shall be applied to any side of the component.	Components must withstand a minimum force of 1 Kg without any failure of the termination to component attachment.
Endurance Characteristics	Cold Temperature Storage	Components shall be stored at temperature of -40 °C ± 2 °C for 1000 (+48 hours -0 hour). Then components shall be subjected to standard atmospheric conditions for 4-48 hours. After that, measurement shall be made.	Table 1. Change In Appearance Without distinct damage
	High Temperature Storage	Components shall be stored at temperature of +85 °C ± 2 °C for 1000 (+48 hours -0 hour). Then components shall be subjected to standard atmospheric conditions for 4-48 hour. After that, measurement shall be made.	
	Moisture Resistance	Components shall be stored in the chamber at 40 °C at 90 - 95% R. H. for 1000 (+48 hours -0 hour). Then components are to be tested after 4-48 hours at room temperature.	Insulation Resistance: 10MΩ min
	Temperature Cycle	Each cycle shall consist of 30 minutes at -40°C followed by 30 minutes at 85°C with a 10-15 minutes maximum transition time between temperature extremes. Test duration is 100 cycles, then components are to be tested after 4-48 hours at room temperature.	Withstanding Voltage: No damaged
	High Temperature With Loaded	Components shall be stored at temperature of +85 °C ± 2 °C for 1000 (+48 hours -0 hour) with rated current applied. Then components shall be subjected to standard atmospheric conditions for 4-48 hour. After that, measurement shall be made.	

Measurement Diagram

Terminal to be Tested

When measuring and supplying the voltage, the following terminal is applied.

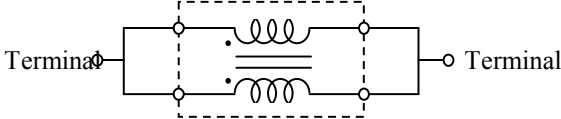
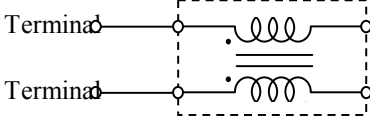
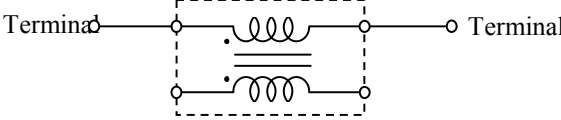
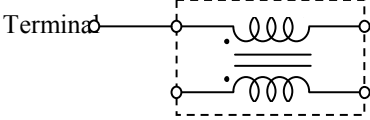
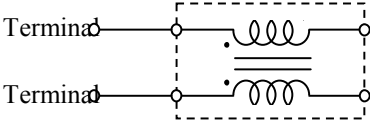
No.	Item	Terminal to be Tested
1	Common Mode Impedance (Measurement Terminal)	
2	Withstanding Voltage (Measurement Terminal)	
3	DC Resistance (Measurement Terminal)	
4	Rated Current	
5	Insulation Resistance	

CHIP INDUCTOR SPECIFICATION

Operating Environment

Do not use this product under the following environmental conditions, on deterioration of performance, such as insulation resistance may result from the use.

1. In corrosive gases (acidic gases, alkaline gases, chlorine, sulfur gases, organic gases and etc.)
2. In the atmosphere where liquid such as organic solvent, may splash on the products.

Storage Condition

1. Storage period

Use the product within 12 months after delivered.

Solderability should be checked if this period is exceeded.

2. Storage environment conditions

- * Product should be store in the warehouse on the following conditions.

Temperature : -10 ~ +40°C

Humidity : 30 to 70% relative humidity. No rapid change on temperature and humidity.

- * Products should not be stored in corrosive gases, such as sulfurous, acid gases, alkaline gases, to prevent the following deterioration.

Poor solderability due to the oxidized electrode.

- * Products should be stored on the pallet for the prevention of the influence from humidity, dust and so on.

- * Products should be stored in the warehouse without heat shock, vibration, direct sunlight and so on.

- * Do not unpack the minimum package until immediately before use. After unpacking, re-seal promptly or store in desiccator with a desiccant.

Delivery

Care should be taken when transporting or handling product to avoid excessive vibration or mechanical shock.

X-ON Electronics

Largest Supplier of Electrical and Electronic Components

Click to view similar products for [Ferrite Beads](#) category:

Click to view products by [Ferrocore](#) manufacturer:

Other Similar products are found below :

[2943778301](#) [BMB1J0120BN3JIT](#) [82350120560](#) [0261014605](#) [2643066902](#) [3061000011](#) [2673045901](#) [2643083601](#) [2643074901](#) [4361142521](#)
[4078078621](#) [4078044821](#) [4078033621](#) [CZB2BFTTE121P](#) [BMB2A0120AN2](#) [BMB1J0200BN3JIT](#) [EMI0805R-220](#) [74279250](#) [7427924](#)
[CZB1JGTTD202P](#) [MAF0603GWY551AT000](#) [MAF1005GWZ102AT000](#) [BLM18HE152SH1D](#) [2944778302](#) [BLM02PX600SN1D](#) [SMB2.5-1](#)
[EMI1206R-600](#) [BLM02KX180SN1D](#) [BLM02BC100SN1D](#) [BLM02KX100SN1D](#) [BLM02BB101SN1D](#) [BLM02BC220SN1D](#)
[BLE32PN260SH1L](#) [BLE32PN260SN1L](#) [BLE32PN260SZ1L](#) [74275013](#) [7427503](#) [BLM18HE601SH1D](#) [BLM15BD152SN1D](#)
[BLM15BD152SZ1D](#) [BLE18PS080SZ1D](#) [BLM21PG221BH1D](#) [WLBD1005HCU330TL](#) [BLM21AG471BH1D](#) [BLE18PS080BH1D](#)
[BLM21AG331BH1D](#) [BLM21PG300BH1D](#) [BLM21PG600BH1D](#) [BLM03HB401SZ1D](#) [BLM03HB401SN1D](#)